

FEATURES

Computes

- True rms value
- Average rectified value
- Absolute value

Provides

- 200 mV full-scale input range (larger inputs with input scaling)
- Direct interfacing with 3½ digit CMOS ADCs
- High input impedance: $10^{12} \Omega$
- Low input bias current: 25 pA maximum
- High accuracy: $\pm 0.2 \text{ mV} \pm 0.3\%$ of reading
- RMS conversion with signal crest factors up to 5
- Wide power supply range: $\pm 2.5 \text{ V}$ to $\pm 16.5 \text{ V}$
- Low power: 25 μA (typical) standby current
- No external trims needed for specified accuracy

The **AD737** output is negative-going; the **AD736** is a positive output-going version of the same basic device

GENERAL DESCRIPTION

The **AD737** is a low power, precision, monolithic, true rms-to-dc converter. It is laser trimmed to provide a maximum error of $\pm 0.2 \text{ mV} \pm 0.3\%$ of reading with sine wave inputs. Furthermore, it maintains high accuracy while measuring a wide range of input waveforms, including variable duty cycle pulses and triac (phase) controlled sine waves. The low cost and small physical size of this converter make it suitable for upgrading the performance of non-rms precision rectifiers in many applications. Compared to these circuits, the **AD737** offers higher accuracy at equal or lower cost.

The **AD737** can compute the rms value of both ac and dc input voltages. It can also be operated ac-coupled by adding one external capacitor. In this mode, the **AD737** can resolve input signal levels of 100 μV rms or less, despite variations in temperature or supply voltage. High accuracy is also maintained for input waveforms with crest factors of 1 to 3. In addition, crest factors as high as 5 can be measured (while introducing only 2.5% additional error) at the 200 mV full-scale input level.

The **AD737** has no output buffer amplifier, thereby significantly reducing dc offset errors occurring at the output, which makes the device highly compatible with high input impedance ADCs.

Requiring only 160 μA of power supply current, the **AD737** is optimized for use in portable multimeters and other battery-powered applications. In power-down mode, the standby supply current in is typically 25 μA .

FUNCTIONAL BLOCK DIAGRAM

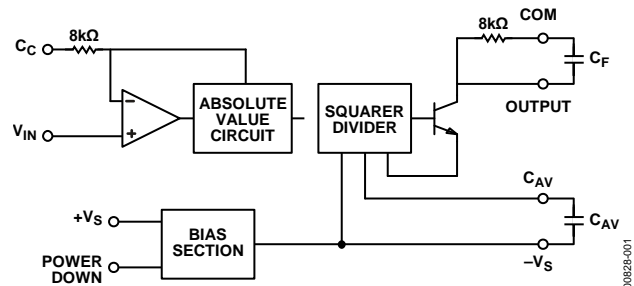

Figure 1.

The **AD737** has both high ($10^{12} \Omega$) and low impedance input options. The high-Z FET input connects high source impedance input attenuators, and a low impedance (8 k Ω) input accepts rms voltages to 0.9 V while operating from the minimum power supply voltage of $\pm 2.5 \text{ V}$. The two inputs can be used either single ended or differentially.

The **AD737** achieves 1% of reading error bandwidth, exceeding 10 kHz for input amplitudes from 20 mV rms to 200 mV rms, while consuming only 0.72 mW.

The **AD737** is available in two performance grades. The **AD737J** and **AD737K** grades operate over the commercial temperature range of 0°C to 70°C . The **AD737JR-5** is tested with supply voltages of $\pm 2.5 \text{ V}$ dc. The **AD737A** grade operates over the industrial temperature range of -40°C to $+85^\circ\text{C}$. The **AD737** is available in two low cost, 8-lead packages: PDIP and SOIC_N.

PRODUCT HIGHLIGHTS

1. Computes average rectified, absolute, or true rms value of a signal regardless of waveform.
2. Only one external component, an averaging capacitor, is required for the **AD737** to perform true rms measurement.
3. The standby power consumption of 125 μW makes the **AD737** suitable for battery-powered applications.

Rev. I

Information furnished by Analog Devices is believed to be accurate and reliable. However, no responsibility is assumed by Analog Devices for its use, nor for any infringements of patents or other rights of third parties that may result from its use. Specifications subject to change without notice. No license is granted by implication or otherwise under any patent or patent rights of Analog Devices. Trademarks and registered trademarks are the property of their respective owners.

TABLE OF CONTENTS

Features	1
Functional Block Diagram	1
General Description	1
Product Highlights	1
Revision History	2
Specifications.....	3
Absolute Maximum Ratings.....	6
Thermal Resistance	6
ESD Caution.....	6
Pin Configurations and Function Descriptions	7
Typical Performance Characteristics	8
Theory of Operation	12
Types of AC Measurement	12

REVISION HISTORY

6/12—Rev. H to Rev. I

Removed CERDIP Package Throughout	Universal
Changes to Features, General Description, Product Highlights Sections and Figure 1	1
Changes to Table 1.....	3
Changes to Table 2.....	6
Deleted Figure 3, Renumbered Sequentially.....	7
Changes to Figure 5, Figure 7, and Figure 8 Captions.....	8
Changes to Figure 12 Caption.....	9
Changes to Figure 19 Caption.....	10
Changes to Figure 23.....	12
Changes to Figure 26.....	14
Changes to Scaling the Output Voltage Section	15
Changes to Figure 27.....	16
Deleted Table 7.....	19
Updated Outline Dimensions	20
Changes to Ordering Guide	21

10/08—Rev. G to Rev. H

Added Selectable Average or RMS Conversion Section and Figure 27	14
Updated Outline Dimensions	20
Changes to Ordering Guide	22

12/06—Rev. F to Rev. G

Changes to Specifications	3
Reorganized Typical Performance Characteristics	8
Changes to Figure 21.....	11
Reorganized Theory of Operation Section	12
Reorganized Applications Section.....	14
Added Scaling Input and Output Voltages Section.....	14
Deleted Application Circuits Heading.....	16
Changes to Figure 28.....	16
Added AD737 Evaluation Board Section.....	18
Updated Outline Dimensions	20

DC Error, Output Ripple, and Averaging Error	13
AC Measurement Accuracy and Crest Factor	13
Calculating Settling Time.....	13
Applications Information	14
RMS Measurement—Choosing an Optimum Value for C_{AV} ...	14
Rapid Settling Times via the Average Responding Connection.....	14
Selecting Practical Values for Capacitors.....	14
Scaling Input and Output Voltages	14
AD737 Evaluation Board.....	18
Outline Dimensions	20
Ordering Guide	21

Changes to Ordering Guide	21
---------------------------------	----

1/05—Rev. E to Rev. F

Updated Format.....	Universal
Added Functional Block Diagram	1
Changes to General Description Section	1
Changes to Pin Configurations and Function Descriptions Section	6
Changes to Typical Performance Characteristics Section	7
Changes to Table 4.....	11
Change to Figure 24	12
Change to Figure 27	15
Changes to Ordering Guide	18

6/03—Rev. D to Rev. E

Added AD737JR-5.....	Universal
Changes to Features	1
Changes to General Description	1
Changes to Specifications.....	2
Changes to Absolute Maximum Ratings.....	4
Changes to Ordering Guide.....	4
Added TPCs 16 through 19	6
Changes to Figures 1 and 2	8
Changes to Figure 8.....	11
Updated Outline Dimensions	12

12/02—Rev. C to Rev. D

Changes to Functional Block Diagram.....	1
Changes to Pin Configuration.....	4
Figure 1 Replaced	8
Changes to Figure 2.....	8
Figure 5 Replaced	10
Changes to Application Circuits Figures 4, 6–8	10
Outline Dimensions Updated.....	12

12/99—Rev. B to Rev. C

SPECIFICATIONS

$T_A = 25^\circ\text{C}$, $\pm V_S = \pm 5\text{ V}$ except as noted, $C_{AV} = 33\ \mu\text{F}$, $C_C = 10\ \mu\text{F}$, $f = 1\ \text{kHz}$, sine wave input applied to Pin 2, unless otherwise specified. Specifications shown in **boldface** are tested on all production units at final electrical test. Results from these tests are used to calculate outgoing quality levels.

Table 1.

Parameter	Test Conditions/ Comments	AD737A, AD737J			AD737K			AD737J-5			Unit
		Min	Typ	Max	Min	Typ	Max	Min	Typ	Max	
ACCURACY											
Total Error	$E_{IN} = 0$ to 200 mV rms $\pm V_S = \pm 2.5\text{ V}$ $\pm V_S = \pm 2.5\text{ V}$, input to Pin 1 $E_{IN} = 200\text{ mV}$ to 1 V rms		0.2/0.3	0.4/0.5		0.2/0.2	0.2/0.3		0.2/0.3	0.4/0.5	$\pm\text{mV}/\pm\text{POR}^1$ $\pm\text{mV}/\pm\text{POR}^1$ $\pm\text{mV}/\pm\text{POR}^1$
Over Temperature			-1.2	± 2.0		-1.2	± 2.0				POR
JN, JR, KR	$E_{IN} = 200\text{ mV rms}$, $\pm V_S = \pm 2.5\text{ V}$		0.007			0.007			0.02		$\pm\text{POR}/^\circ\text{C}$
AN and AR	$E_{IN} = 200\text{ mV rms}$, $\pm V_S = \pm 2.5\text{ V}$		0.014			0.014					$\pm\text{POR}/^\circ\text{C}$
vs. Supply Voltage											
	$E_{IN} = 200\text{ mV rms}$, $\pm V_S = \pm 2.5\text{ V}$ to $\pm 5\text{ V}$	0	-0.18	-0.3	0	-0.18	-0.3	0	-0.18	-0.3	%/V
	$E_{IN} = 200\text{ mV rms}$, $\pm V_S = \pm 5\text{ V}$ to $\pm 16.5\text{ V}$	0	0.06	0.1	0	0.06	0.1	0	0.06	0.1	%/V
DC Reversal Error	DC-coupled, $V_{IN} = 600\text{ mV dc}$ $\pm V_S = \pm 2.5\text{ V}$ $V_{IN} = 200\text{ mV dc}$		1.3	2.5		1.3	2.5				POR
									1.7	2.5	POR
Nonlinearity ²	$E_{IN} = 0$ mV to 200 mV rms, @ 100 mV rms	0	0.25	0.35	0	0.25	0.35				POR
Input to Pin 1 ³	AC coupled, $E_{IN} = 100\text{ mV rms}$, after correction, $\pm V_S = \pm 2.5\text{ V}$								0.02	0.1	POR
Total Error, External Trim	$E_{IN} = 0$ mV to 200 mV rms		0.1/0.2			0.1/0.2			0.1/0.2		$\pm\text{mV}/\pm\text{POR}$
ADDITIONAL CREST FACTOR ERROR ⁴											
For Crest Factors from 1 to 3	$C_{AV} = C_F = 100\ \mu\text{F}$		0.7			0.7					%
	$C_{AV} = 22\ \mu\text{F}$, $C_F = 100\ \mu\text{F}$, $\pm V_S = \pm 2.5\text{ V}$, input to Pin 1								1.7		%
For Crest Factors from 3 to 5	$C_{AV} = C_F = 100\ \mu\text{F}$		2.5			2.5					%
INPUT CHARACTERISTICS											
High-Z Input (Pin 2) Signal Range											
Continuous RMS Level	$\pm V_S = +2.5\text{ V}$									200	mV rms
	$\pm V_S = +2.8\text{ V}/-3.2\text{ V}$			200			200				mV rms
	$\pm V_S = \pm 5\text{ V}$ to $\pm 16.5\text{ V}$			1			1				V rms

Parameter	Test Conditions/ Comments	AD737A, AD737J			AD737K			AD737J-5			Unit
		Min	Typ	Max	Min	Typ	Max	Min	Typ	Max	
Peak Transient Input	$\pm V_S = +2.5$ V input to Pin 1							± 0.6			V
	$\pm V_S = +2.8$ V/ -3.2 V	± 0.9				± 0.9					V
	$\pm V_S = \pm 5$ V		± 2.7				± 2.7				V
	$\pm V_S = \pm 16.5$ V	± 4.0				± 4.0					V
Input Resistance			1012			1012			1012		Ω
Input Bias Current	$\pm V_S = \pm 5$ V		1	25		1	25		1	25	pA
Low-Z Input (Pin 1) Signal Range	Continuous RMS Level									300	mV rms
	$\pm V_S = +2.8$ V/ -3.2 V			300			300				mV rms
	$\pm V_S = \pm 5$ V to ± 16.5 V			1			1				V rms
Peak Transient Input	$\pm V_S = +2.5$ V								± 1.7		V
	$\pm V_S = +2.8$ V/ -3.2 V		± 1.7			± 1.7					V
	$\pm V_S = \pm 5$ V		± 3.8			± 3.8					V
	$\pm V_S = \pm 16.5$ V		± 11			± 11					V
Input Resistance		6.4	8	9.6	6.4	8	9.6	6.4	8	9.6	k Ω
Maximum Continuous Nondestructive Input	All supply voltages			± 12			± 12			± 12	V p-p
Input Offset Voltage ⁵	AC-coupled			± 3			± 3			± 3	mV
Over the Rated Operating Temperature Range			8	30		8	30		8	30	μ V/ $^{\circ}$ C
vs. Supply	$V_S = \pm 2.5$ V to ± 5 V		80			80			80		μ V/V
	$V_S = \pm 5$ V to ± 16.5 V		50	150		50	150				μ V/V
OUTPUT CHARACTERISTICS	No load, output is negative with respect to COM										
Output Voltage Range	$\pm V_S = +2.8$ V/ -3.2 V	-1.6	-1.7		-1.6	-1.7					V ⁶
	$\pm V_S = \pm 5$ V	-3.3	-3.4		-3.3	-3.4					V ⁶
	$\pm V_S = \pm 16.5$ V	-4	-5		-4	-5					V
	$\pm V_S = \pm 2.5$ V, input to Pin 1							-1.1	-0.9		V ⁶
Output Resistance	DC	6.4	8	9.6	6.4	8	9.6	6.4	8	9.6	k Ω
FREQUENCY RESPONSE											
High-Z Input (Pin 2) 1% Additional Error	$V_{IN} = 1$ mV rms		1			1			1		kHz
	$V_{IN} = 10$ mV rms		6			6			6		kHz
	$V_{IN} = 100$ mV rms		37			37			37		kHz
	$V_{IN} = 200$ mV rms		33			33			33		kHz

Parameter	Test Conditions/ Comments	AD737A, AD737J			AD737K			AD737J-5			Unit
		Min	Typ	Max	Min	Typ	Max	Min	Typ	Max	
3 dB Bandwidth	$V_{IN} = 1$ mV rms		5		5			5			kHz
	$V_{IN} = 10$ mV rms		55		55			55			kHz
	$V_{IN} = 100$ mV rms		170		170			170			kHz
	$V_{IN} = 200$ mV rms		190		190			190			kHz
Low-Z Input (Pin 1) 1% Additional Error	$V_{IN} = 1$ mV rms		1		1			1			kHz
	$V_{IN} = 10$ mV rms		6		6			6			kHz
	$V_{IN} = 40$ mV rms							25			kHz
	$V_{IN} = 100$ mV rms		90		90			90			kHz
3 dB Bandwidth	$V_{IN} = 200$ mV rms		90		90			90			kHz
	$V_{IN} = 1$ mV rms		5		5			5			kHz
	$V_{IN} = 10$ mV rms		55		55			55			kHz
	$V_{IN} = 100$ mV rms		350		350			350			kHz
POWER-DOWN MODE											
	Disable Voltage		0		0						V
Input Current, PD Enabled	$V_{PD} = V_S$		11		11						μ A
POWER SUPPLY											
Operating Voltage Range		+2.8/ -3.2	± 5	± 16.5	+2.8/ -3.2	± 5	± 16.5	± 2.5	± 5	± 16.5	V
Current	No input		120	160	120	160		120	160		μ A
	Rated input		170	210	170	210		170	210		μ A
	Powered down		25	40	25	40		25	40		μ A

¹ POR is % of reading.

² Nonlinearity is defined as the maximum deviation (in percent error) from a straight line connecting the readings at 0 V and at 200 mV rms.

³ After fourth-order error correction using the equation

$$y = -0.31009x^4 - 0.21692x^3 - 0.06939x^2 + 0.99756x + 11.1 \times 10^{-6}$$

where y is the corrected result and x is the device output between 0.01 V and 0.3 V.

⁴ Crest factor error is specified as the additional error resulting from the specific crest factor, using a 200 mV rms signal as a reference. The crest factor is defined as V_{PEAK}/V_{RMS} .

⁵ DC offset does not limit ac resolution.

⁶ Value is measured with respect to COM.

ABSOLUTE MAXIMUM RATINGS

Table 2.

Parameter	Rating
Supply Voltage	± 16.5 V
Internal Power Dissipation	200 mW
Input Voltage	
Pin 1	± 12 V
Pin 2 to Pin 8	$\pm V_s$
Output Short-Circuit Duration	Indefinite
Differential Input Voltage	$+V_s$ and $-V_s$
Storage Temperature Range	-65°C to $+125^\circ\text{C}$
Lead Temperature, Soldering (60 sec)	300°C
ESD Rating	500 V

Stresses above those listed under Absolute Maximum Ratings may cause permanent damage to the device. This is a stress rating only; functional operation of the device at these or any other conditions above those indicated in the operational section of this specification is not implied. Exposure to absolute maximum rating conditions for extended periods may affect device reliability.

THERMAL RESISTANCE

θ_{JA} is specified for the worst-case conditions, that is, a device soldered in a circuit board for surface-mount packages.

Table 3. Thermal Resistance

Package Type	θ_{JA}	Unit
8-Lead PDIP (N-8)	165	$^\circ\text{C}/\text{W}$
8-Lead SOIC_N (R-8)	155	$^\circ\text{C}/\text{W}$

ESD CAUTION



ESD (electrostatic discharge) sensitive device. Charged devices and circuit boards can discharge without detection. Although this product features patented or proprietary protection circuitry, damage may occur on devices subjected to high energy ESD. Therefore, proper ESD precautions should be taken to avoid performance degradation or loss of functionality.

PIN CONFIGURATIONS AND FUNCTION DESCRIPTIONS

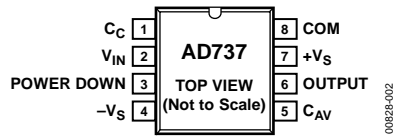

Figure 2. SOIC_N Pin Configuration (R-8)

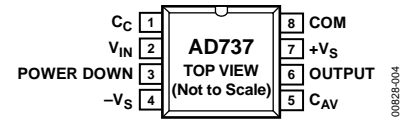

Figure 3. PDIP Pin Configuration (N-8)

Table 4. Pin Function Descriptions

Pin No.	Mnemonic	Description
1	C_c	Coupling Capacitor for Indirect DC Coupling.
2	V_{IN}	RMS Input.
3	POWER DOWN	Disables the AD737. Low is enabled; high is powered down.
4	$-V_s$	Negative Power Supply.
5	C_{AV}	Averaging Capacitor.
6	OUTPUT	Output.
7	$+V_s$	Positive Power Supply.
8	COM	Common.

TYPICAL PERFORMANCE CHARACTERISTICS

$T_A = 25^\circ\text{C}$, $\pm V_S = \pm 5\text{ V}$ (except AD737J-5, where $\pm V_S = \pm 2.5\text{ V}$), $C_{AV} = 33\ \mu\text{F}$, $C_C = 10\ \mu\text{F}$, $f = 1\ \text{kHz}$, sine wave input applied to Pin 2, unless otherwise specified.

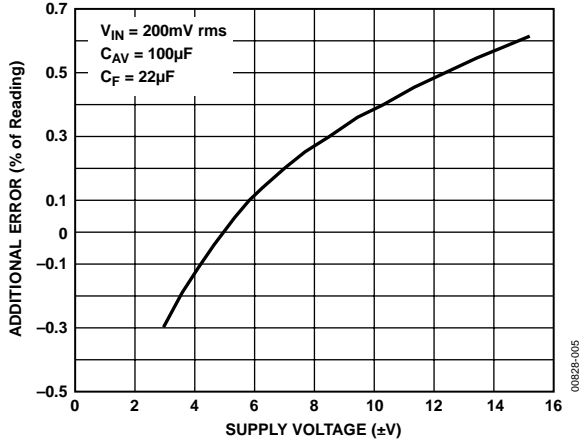

Figure 4. Additional Error vs. Supply Voltage

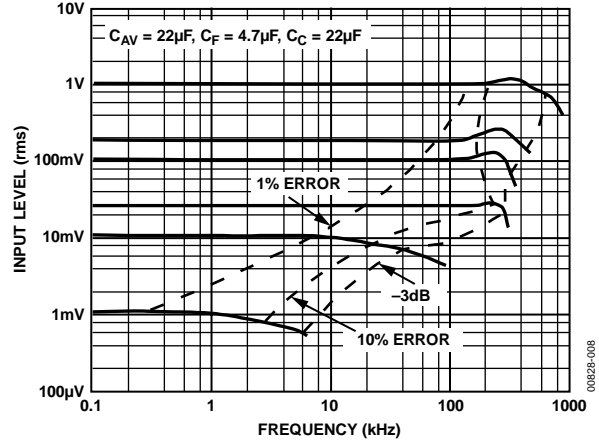

Figure 7. Frequency Response Driving Pin 1; Negative DC Output

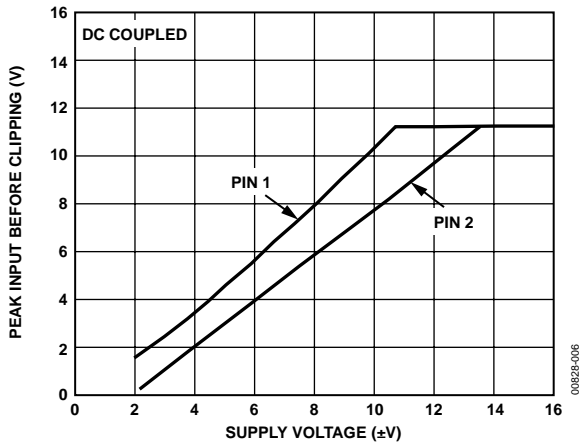

Figure 5. Peak Input Level for 1% Saturation vs. Supply Voltage

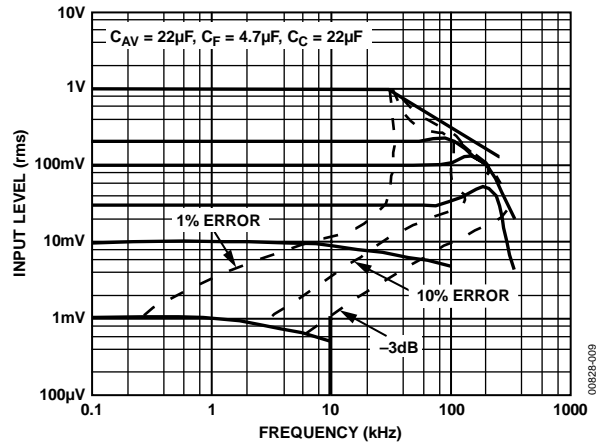

Figure 8. Frequency Response Driving Pin 2; Negative DC Output

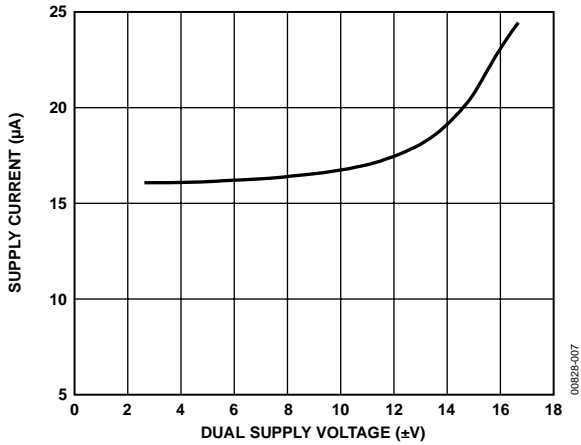

Figure 6. Supply Current (Power-Down Mode) vs. Supply Voltage (Dual)

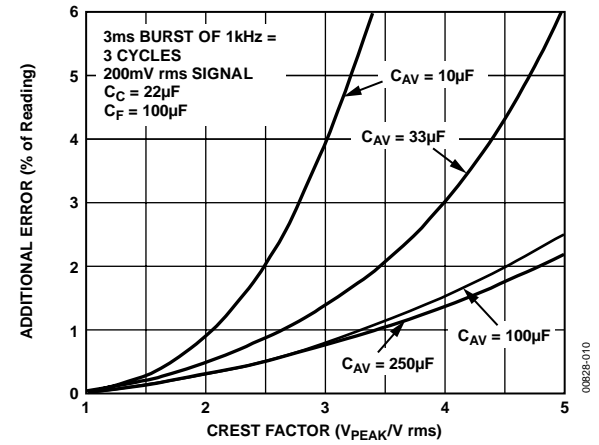

Figure 9. Additional Error vs. Crest Factor

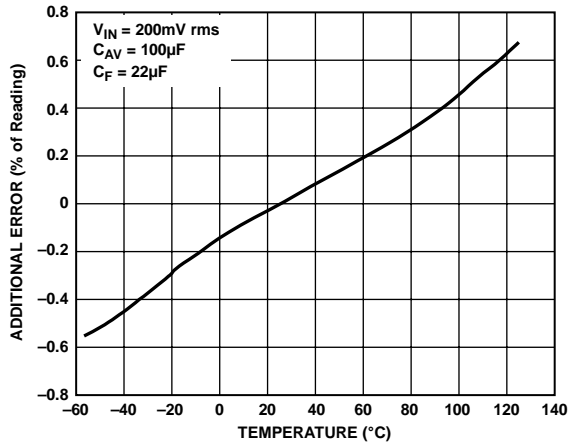

Figure 10. Additional Error vs. Temperature

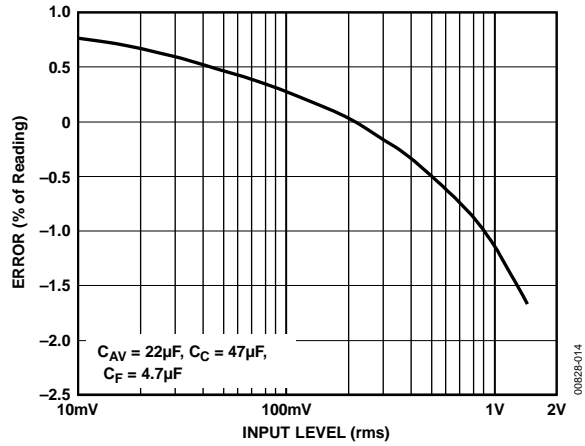

Figure 13. Error vs. RMS Input Level Using Circuit in Figure 29

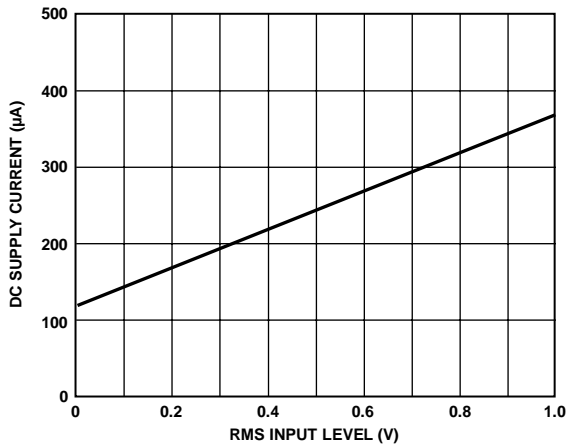

Figure 11. DC Supply Current vs. RMS Input Level

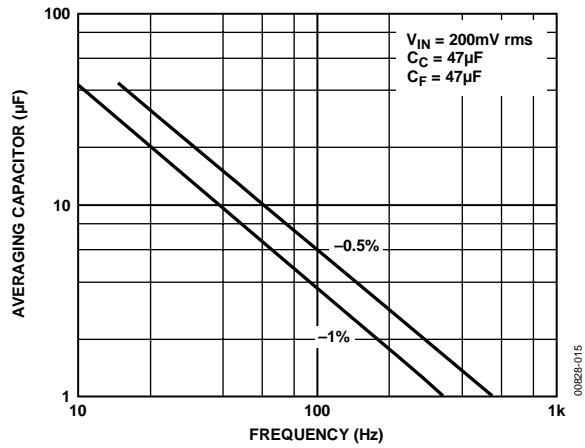

Figure 14. Value of Averaging Capacitor vs. Frequency for Specified Averaging Error

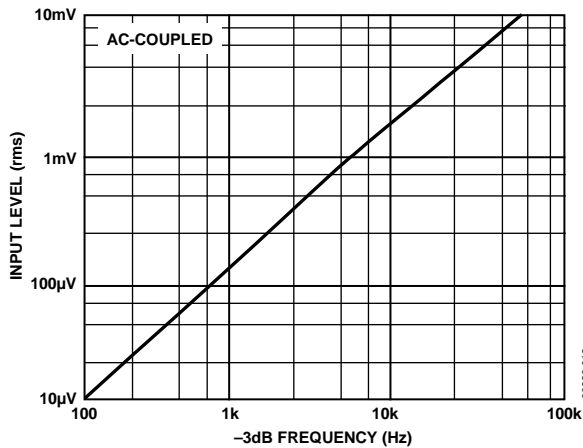

Figure 12. RMS Input Level vs. -3 dB Frequency; Negative DC Output

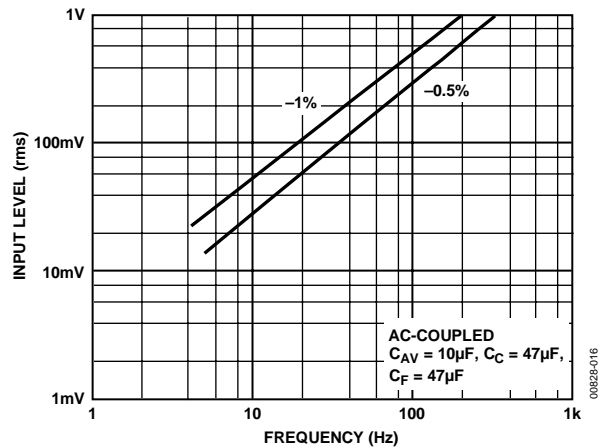

Figure 15. RMS Input Level vs. Frequency for Specified Averaging Error

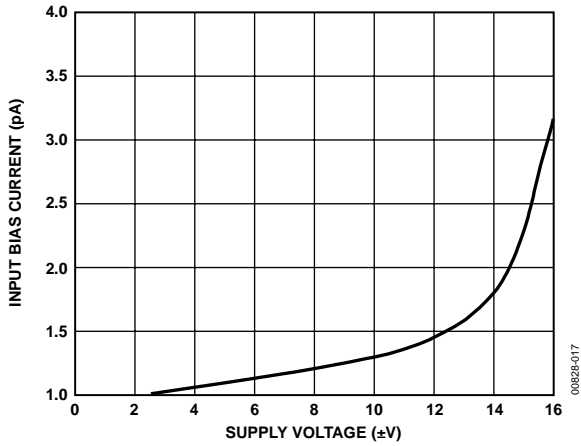

Figure 16. Input Bias Current vs. Supply Voltage

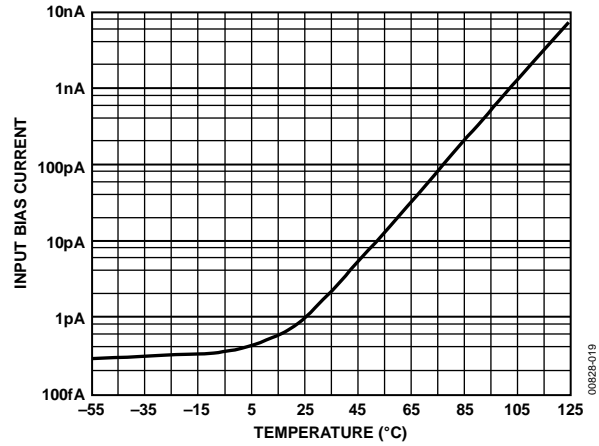

Figure 18. Input Bias Current vs. Temperature

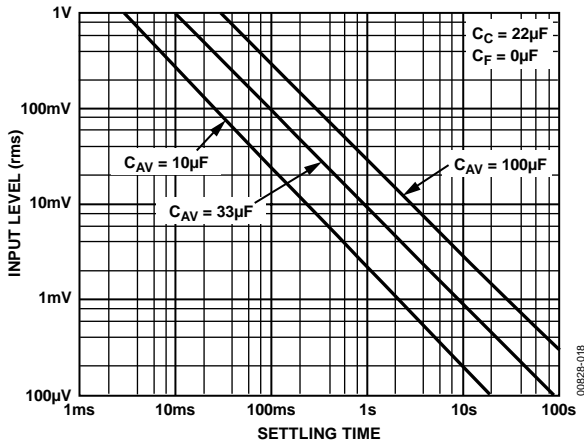

Figure 17. RMS Input Level vs. Settling Time for Three Values of C_{AV}

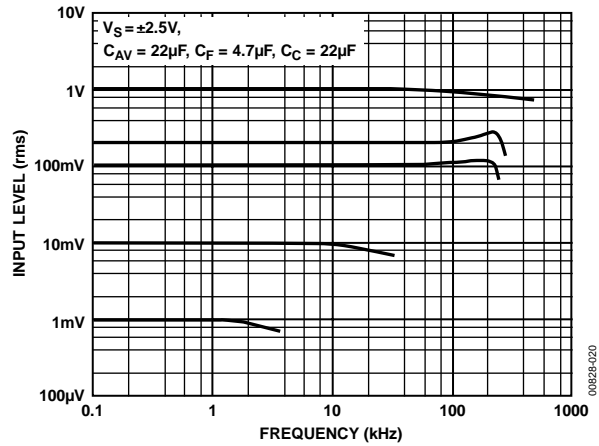

Figure 19. Frequency Response Driving Pin 1; Negative DC Output

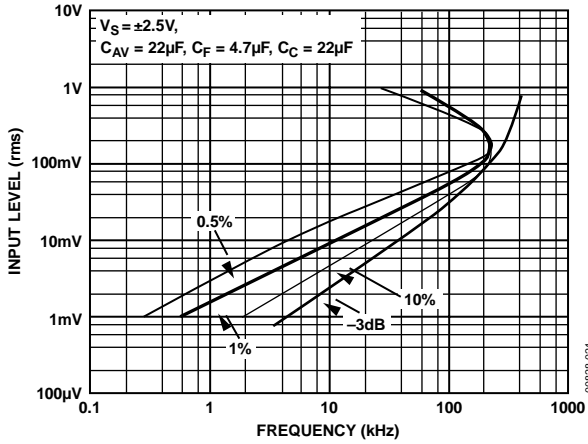

Figure 20. Error Contours Driving Pin 1

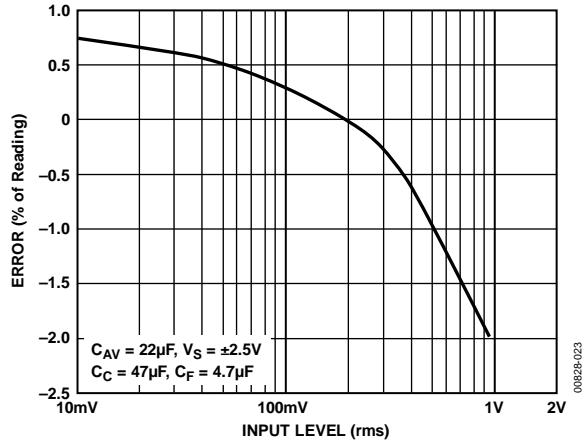

Figure 22. Error vs. RMS Input Level Driving Pin 1

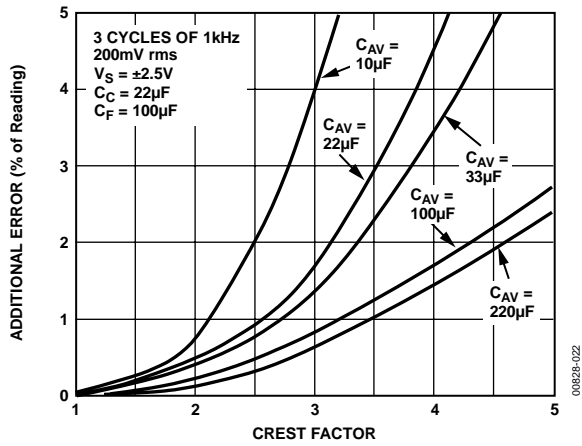

Figure 21. Additional Error vs. Crest Factor for Various Values of C_{AV}

THEORY OF OPERATION

As shown in Figure 23, the AD737 has four functional subsections: an input amplifier, a full-wave rectifier, an rms core, and a bias section. The FET input amplifier allows a high impedance, buffered input at Pin 2 or a low impedance, wide dynamic range input at Pin 1. The high impedance input, with its low input bias current, is ideal for use with high impedance input attenuators. The input signal can be either dc-coupled or ac-coupled to the input amplifier. Unlike other rms converters, the AD737 permits both direct and indirect ac coupling of the inputs. AC coupling is provided by placing a series capacitor between the input signal and Pin 2 (or Pin 1) for direct coupling and between Pin 1 and ground (while driving Pin 2) for indirect coupling.

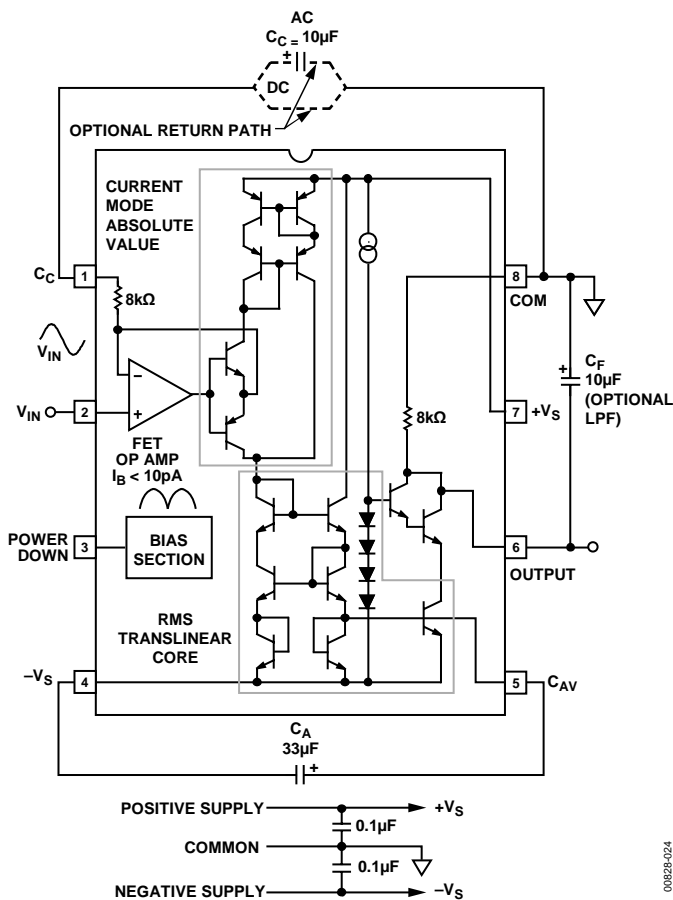

Figure 23. AD737 True RMS Circuit (Test Circuit)

The output of the input amplifier drives a full-wave precision rectifier, which, in turn, drives the rms core. It is the core that provides the essential rms operations of squaring, averaging, and square rooting, using an external averaging capacitor, C_{AV} .

Without C_{AV} , the rectified input signal passes through the core unprocessed, as is done with the average responding connection (see Figure 25). In the average responding mode, averaging is carried out by an RC post filter consisting of an 8 kΩ internal scale factor resistor connected between Pin 6 and Pin 8 and an

external averaging capacitor, C_F . In the rms circuit, this additional filtering stage reduces any output ripple that was not removed by the averaging capacitor.

Finally, the bias subsection permits a power-down function. This reduces the idle current of the AD737 from 160 μA to 30 μA. This feature is selected by connecting Pin 3 to Pin 7 (+ V_S).

TYPES OF AC MEASUREMENT

The AD737 is capable of measuring ac signals by operating as either an average responding converter or a true rms-to-dc converter. As its name implies, an average responding converter computes the average absolute value of an ac (or ac and dc) voltage or current by full-wave rectifying and low-pass filtering the input signal; this approximates the average. The resulting output, a dc average level, is then scaled by adding (or reducing) gain; this scale factor converts the dc average reading to an rms equivalent value for the waveform being measured. For example, the average absolute value of a sine wave voltage is 0.636 that of V_{PEAK} ; the corresponding rms value is 0.707 times V_{PEAK} . Therefore, for sine wave voltages, the required scale factor is 1.11 (0.707 divided by 0.636).

In contrast to measuring the average value, true rms measurement is a universal language among waveforms, allowing the magnitudes of all types of voltage (or current) waveforms to be compared to one another and to dc. RMS is a direct measure of the power or heating value of an ac voltage compared to that of a dc voltage; an ac signal of 1 V rms produces the same amount of heat in a resistor as a 1 V dc signal.

Mathematically, the rms value of a voltage is defined (using a simplified equation) as

$$V_{rms} = \sqrt{\text{Avg}(V^2)}$$

This involves squaring the signal, taking the average, and then obtaining the square root. True rms converters are smart rectifiers; they provide an accurate rms reading regardless of the type of waveform being measured. However, average responding converters can exhibit very high errors when their input signals deviate from their precalibrated waveform; the magnitude of the error depends on the type of waveform being measured. As an example, if an average responding converter is calibrated to measure the rms value of sine wave voltages and then is used to measure either symmetrical square waves or dc voltages, the converter has a computational error 11% (of reading) higher than the true rms value (see Table 5).

The transfer function for the AD737 is

$$V_{OUT} = \sqrt{\text{Avg}(V_{IN}^2)}$$

DC ERROR, OUTPUT RIPPLE, AND AVERAGING ERROR

Figure 24 shows the typical output waveform of the AD737 with a sine wave input voltage applied. As with all real-world devices, the ideal output of $V_{OUT} = V_{IN}$ is never exactly achieved; instead, the output contains both a dc and an ac error component.

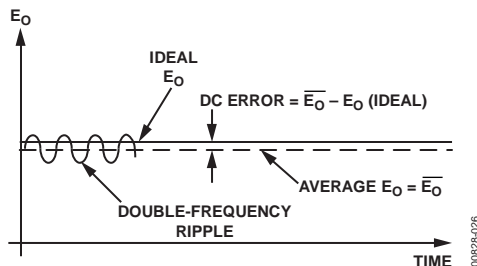

Figure 24. Output Waveform for Sine Wave Input Voltage

As shown, the dc error is the difference between the average of the output signal (when all the ripple in the output has been removed by external filtering) and the ideal dc output. The dc error component is, therefore, set solely by the value of the averaging capacitor used—no amount of post filtering (using a very large postfiltering capacitor, C_F) allows the output voltage to equal its ideal value. The ac error component, an output ripple, can be easily removed using a large enough C_F .

In most cases, the combined magnitudes of the dc and ac error components must be considered when selecting appropriate values for C_{AV} and C_F capacitors. This combined error, representing the maximum uncertainty of the measurement, is termed the averaging error and is equal to the peak value of the output ripple plus the dc error. As the input frequency increases, both error components decrease rapidly. If the input frequency doubles, the dc error and ripple reduce to one-quarter and one-half of their original values, respectively, and rapidly become insignificant.

AC MEASUREMENT ACCURACY AND CREST FACTOR

The crest factor of the input waveform is often overlooked when determining the accuracy of an ac measurement. Crest factor is defined as the ratio of the peak signal amplitude to the rms amplitude (crest factor = V_{PEAK}/V_{rms}). Many common waveforms, such as sine and triangle waves, have relatively low crest factors (≥ 2). Other waveforms, such as low duty cycle pulse trains and SCR waveforms, have high crest factors. These types of waveforms require a long averaging time constant to average out the long time periods between pulses. Figure 9 shows the additional error vs. the crest factor of the AD737 for various values of C_{AV} .

CALCULATING SETTLING TIME

Figure 17 can be used to closely approximate the time required for the AD737 to settle when its input level is reduced in amplitude. The net time required for the rms converter to settle is the difference between two times extracted from the graph: the initial time minus the final settling time. As an example, consider the following conditions: a 33 μF averaging capacitor, an initial rms input level of 100 mV, and a final (reduced) input level of 1 mV. From Figure 17, the initial settling time (where the 100 mV line intersects the 33 μF line) is approximately 80 ms. The settling time corresponding to the new or final input level of 1 mV is approximately 8 seconds. Therefore, the net time for the circuit to settle to its new value is 8 seconds minus 80 ms, which is 7.92 seconds.

Note that, because of the inherent smoothness of the decay characteristic of a capacitor/diode combination, this is the total settling time to the final value (not the settling time to 1%, 0.1%, and so on, of the final value). Also, this graph provides the worst-case settling time because the AD737 settles very quickly with increasing input levels.

Table 5. Error Introduced by an Average Responding Circuit When Measuring Common Waveforms

Type of Waveform 1 V Peak Amplitude	Crest Factor (V_{PEAK}/V_{rms})	True RMS Value (V)	Reading of an Average Responding Circuit Calibrated to an RMS Sine Wave Value (V)	Error (%)
Undistorted Sine Wave	1.414	0.707	0.707	0
Symmetrical Square Wave	1.00	1.00	1.11	11.0
Undistorted Triangle Wave	1.73	0.577	0.555	-3.8
Gaussian Noise (98% of Peaks <1 V)	3	0.333	0.295	-11.4
Rectangular	2	0.5	0.278	-44
Pulse Train	10	0.1	0.011	-89
SCR Waveforms				
50% Duty Cycle	2	0.495	0.354	-28
25% Duty Cycle	4.7	0.212	0.150	-30

APPLICATIONS INFORMATION

RMS MEASUREMENT—CHOOSING AN OPTIMUM VALUE FOR C_{AV}

Because the external averaging capacitor, C_{AV} , holds the rectified input signal during rms computation, its value directly affects the accuracy of the rms measurement, especially at low frequencies. Furthermore, because the averaging capacitor is connected across a diode in the rms core, the averaging time constant (τ_{AV}) increases exponentially as the input signal decreases. It follows that decreasing the input signal decreases errors due to nonideal averaging but increases the settling time approaching the decreased rms-computed dc value. Thus, diminishing input values allow the circuit to perform better (due to increased averaging) while increasing the waiting time between measurements. A trade-off must be made between computational accuracy and settling time when selecting C_{AV} .

RAPID SETTLING TIMES VIA THE AVERAGE RESPONDING CONNECTION

Because the average responding connection shown in Figure 25 does not use an averaging capacitor, its settling time does not vary with input signal level; it is determined solely by the RC time constant of C_F and the internal 8 k Ω output scaling resistor.

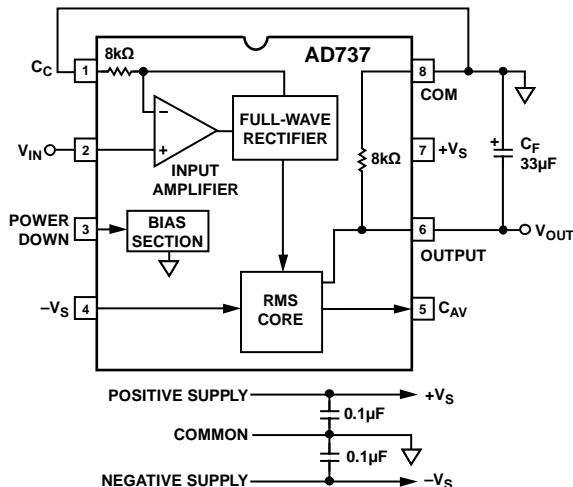

Figure 25. *AD737* Average Responding Circuit

Selectable Average or RMS Conversion

For some applications, it is desirable to be able to select between rms-value-to-dc conversion and average-value-to-dc conversion. If C_{AV} is disconnected from the root-mean core, the *AD737* full-wave rectifier is a highly accurate absolute value circuit. A CMOS switch whose gate is controlled by a logic level selects between average and rms values.

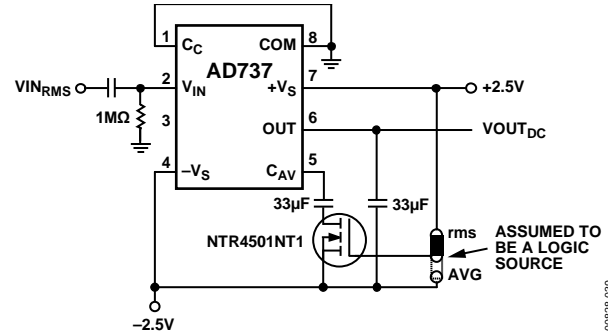

Figure 26. *CMOS* Switch Is Used to Select RMS or Average Responding Modes

SELECTING PRACTICAL VALUES FOR CAPACITORS

Table 6 provides practical values of C_{AV} and C_F for several common applications.

The input coupling capacitor, C_C , in conjunction with the 8 k Ω internal input scaling resistor, determines the -3 dB low frequency roll-off. This frequency, F_L , is equal to

$$F_L = \frac{1}{2\pi \times 8000 \times C_C} \quad (\text{in Farads}) \quad (1)$$

Note that, at F_L , the amplitude error is approximately -30% (-3 dB) of reading. To reduce this error to 0.5% of reading, choose a value of C_C that sets F_L at one-tenth of the lowest frequency to be measured.

In addition, if the input voltage has more than 100 mV of dc offset, the ac coupling network at Pin 2 is required in addition to Capacitor C_C .

SCALING INPUT AND OUTPUT VOLTAGES

The *AD737* is an extremely flexible device. With minimal external circuitry, it can be powered with single- or dual-polarity power supplies, and input and output voltages are independently scalable to accommodate nonmatching I/O devices. This section describes a few such applications.

Extending or Scaling the Input Range

For low supply voltage applications, the maximum peak voltage to the device is extended by simply applying the input voltage to Pin 1 across the internal 8 k Ω input resistor. The *AD737* input circuit functions quasi-differentially, with a high impedance FET input at Pin 2 (noninverting) and a low impedance input at Pin 1 (inverting, see Figure 25). The internal 8 k Ω resistor behaves as a voltage-to-current converter connected to the summing node of a feedback loop around the input amplifier. Because the feedback loop acts to servo the summing node voltage to match the voltage at Pin 2, the maximum peak input voltage increases until the internal circuit runs out of headroom, approximately double for a symmetrical dual supply.

Battery Operation

All the level-shifting for battery operation is provided by the 3½ digit converter, shown in Figure 27. Alternatively, an external op amp adds flexibility by accommodating nonzero common-mode voltages and providing output scaling and offset to zero. When an external operational amplifier is used, the output polarity is positive going.

Figure 28 shows an op amp used in a single-supply application. Note that the combined input resistor value ($R1 + R2 + 8\text{ k}\Omega$) matches that of the $R5$ feedback resistor. In this instance, the magnitudes of the output dc voltage and the rms of the ac input are equal. $R3$ and $R4$ provide current to offset the output to 0 V.

Scaling the Output Voltage

The output voltage can be scaled to the input rms voltage. For example, assume that the AD737 is retrofitted to an existing application using an averaging responding circuit (full-wave rectifier). The power supply is 12 V, the input voltage is 10 V ac, and the desired output is 6 V dc.

For convenience, use the same combined input resistance as shown in Figure 28. Calculate the rms input current as

$$I_{INMAG} = \frac{10\text{ V}}{69.8\text{ k}\Omega + 2.5\text{ k}\Omega + 8\text{ k}\Omega} = 125\text{ }\mu\text{A} = I_{OUTMAG} \quad (2)$$

Next, using the I_{OUTMAG} value from Equation 2, calculate the new feedback resistor value ($R5$) required for 6 V output using

$$R5 = \frac{6\text{ V}}{125\text{ }\mu\text{A}} = 48.1\text{ k}\Omega \quad (3)$$

Select the closest-value standard 1% resistor, 47.5 kΩ.

Because the supply is 12 V, the common-mode voltage at the $R7/R8$ divider is 6 V, and the combined resistor value ($R3 + R4$) is equal to the feedback resistor, or 47.5 kΩ.

$R2$ is used to calibrate the transfer function (gain), and $R4$ sets the output voltage to zero with no input voltage.

Perform calibration as follows:

1. With no ac input applied, adjust $R4$ for 0 V.
2. Apply a known input to the input.
3. Adjust the $R2$ trimmer until the input and output match.

The op amp selected for any single-supply application must be a rail-to-rail type, for example an AD8541, as shown in Figure 28. For higher voltages, a higher voltage part, such as an OP196, can be used. When calibrating to 0 V, the specified voltage above ground for the operational amplifier must be taken into account. Adjust $R4$ slightly higher as appropriate.

Table 6. AD737 Capacitor Selection

Application	RMS Input Level	Low Frequency Cutoff (−3 dB)	Maximum Crest Factor	C_{AV} (μF)	C_F (μF)	Settling Time ¹ to 1%
General-Purpose RMS Computation	0 V to 1 V	20 Hz	5	150	10	360 ms
		200 Hz	5	15	1	36 ms
	0 mV to 200 mV	20 Hz	5	33	10	360 ms
		200 Hz	5	3.3	1	36 ms
General-Purpose Average Responding	0 V to 1 V	20 Hz		None	33	1.2 sec
		200 Hz		None	3.3	120 ms
	0 mV to 200 mV	20 Hz		None	33	1.2 sec
		200 Hz		None	3.3	120 ms
SCR Waveform Measurement	0 mV to 200 mV	50 Hz	5	100	33	1.2 sec
		60 Hz	5	82	27	1.0 sec
	0 mV to 100 mV	50 Hz	5	50	33	1.2 sec
		60 Hz	5	47	27	1.0 sec
Audio Applications	0 mV to 200 mV	300 Hz	3	1.5	0.5	18 ms
	0 mV to 100 mV	20 Hz	10	100	68	2.4 sec

¹ Settling time is specified over the stated rms input level with the input signal increasing from zero. Settling times are greater for decreasing amplitude input signals.

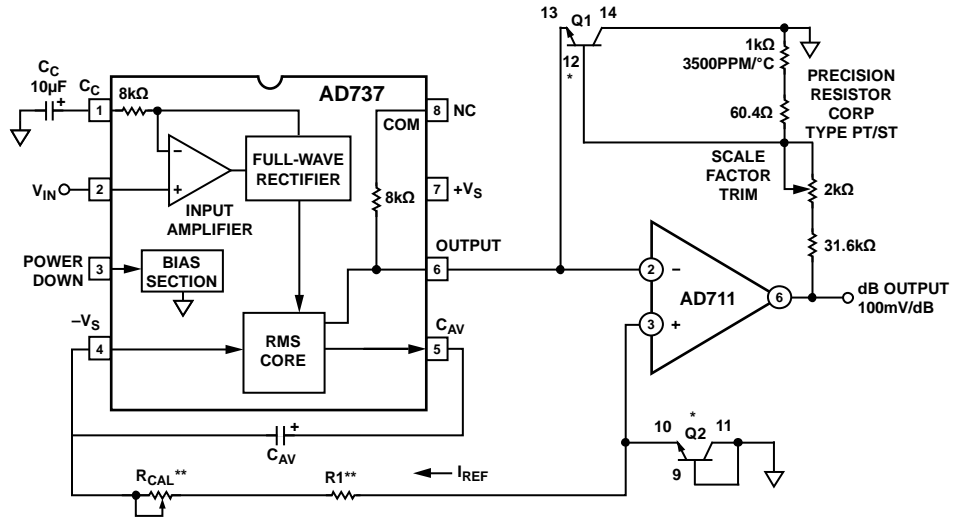

NC = NO CONNECT
 *Q1, Q2 PART OF RCA CA3046 OR SIMILAR NPN TRANSISTOR ARRAY.

$$**R1 + R_{CAL} \text{ IN } \Omega = 10,000 \times \frac{4.3V}{\text{0dB INPUT LEVEL IN V}}$$

Figure 30. dB Output Connection

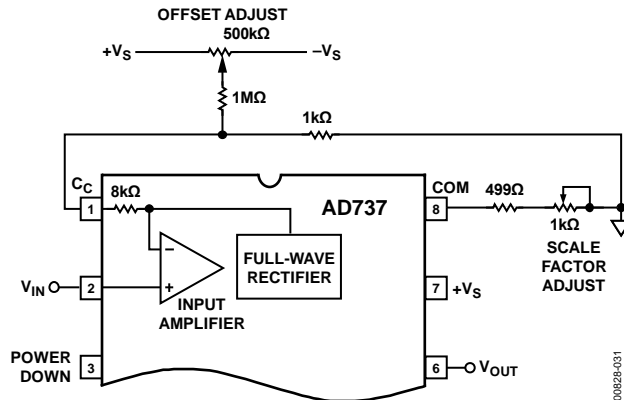

Figure 31. DC-Coupled Offset Voltage and Scale Factor Trims

00828-030

00828-031

AD737 EVALUATION BOARD

An evaluation board, [AD737-EVALZ](#), is available for experiments or for becoming familiar with rms-to-dc converters. Figure 32 is a photograph of the board; Figure 34 to Figure 37 show the signal and power plane copper patterns. The board is designed for multipurpose applications and can be used for the AD736 as well. Although not shipped with the board, an optional socket that accepts the 8-lead surface-mount package is available from Enplas Corp.

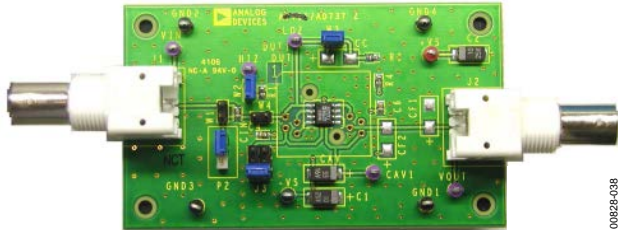

Figure 32. AD737 Evaluation Board

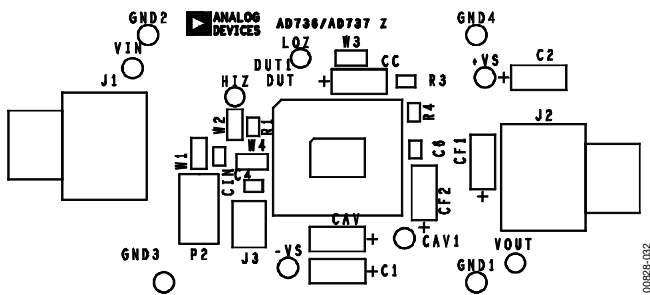

Figure 33. AD737 Evaluation Board—Component-Side Silkscreen

As described in the Applications Information section, the [AD737](#) can be connected in a variety of ways. As shipped, the board is configured for dual supplies with the high impedance input connected and the power-down feature disabled. Jumpers are provided for connecting the input to the low impedance input (Pin 1) and for dc connections to either input. The schematic with movable jumpers is shown in Figure 38. The jumper positions in black are default connections; the dotted-outline jumpers are optional connections. The board is tested prior to shipment and requires only a power supply connection and a precision meter to perform measurements.

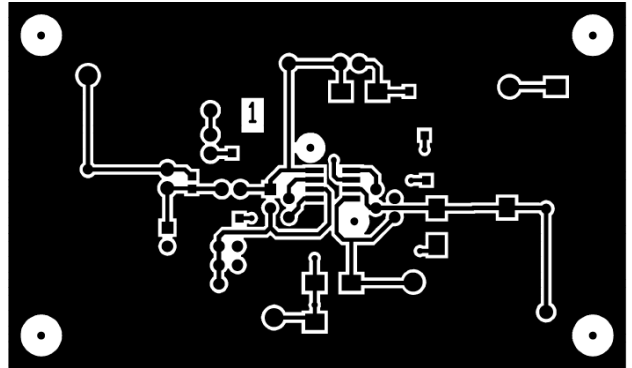

Figure 34. AD737 Evaluation Board—Component-Side Copper

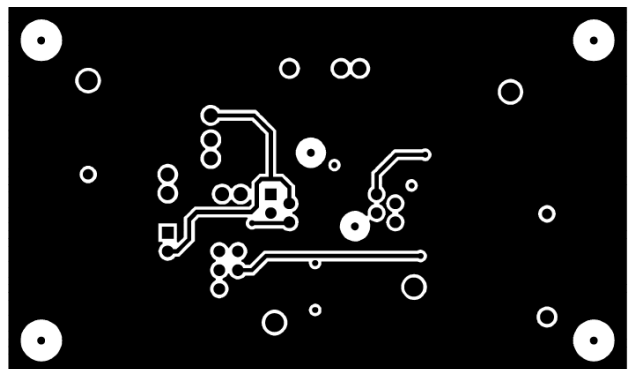

Figure 35. AD737 Evaluation Board—Secondary-Side Copper

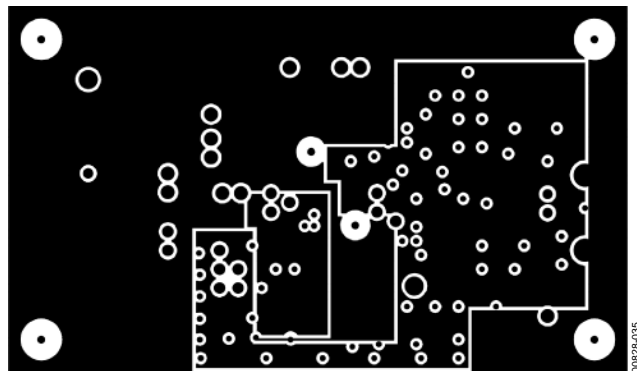

Figure 36. AD737 Evaluation Board—Internal Power Plane

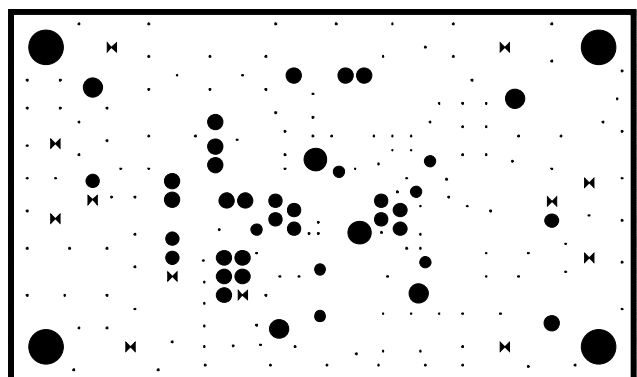

Figure 37. AD737 Evaluation Board—Internal Ground Plane

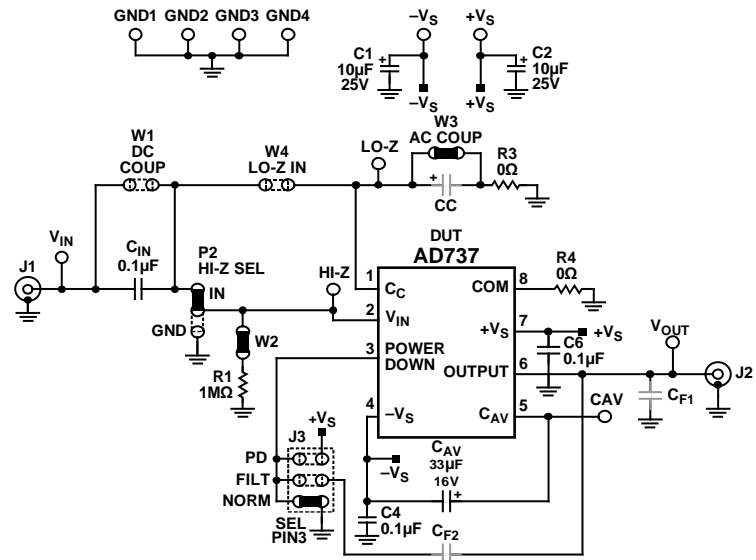
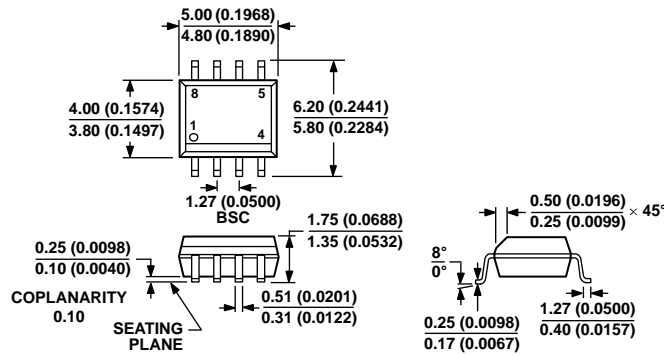

Figure 38. AD737 Evaluation Board Schematic

00828-037

OUTLINE DIMENSIONS



COMPLIANT TO JEDEC STANDARDS MS-012-AA
 CONTROLLING DIMENSIONS ARE IN MILLIMETERS; INCH DIMENSIONS
 (IN PARENTHESES) ARE ROUNDED-OFF MILLIMETER EQUIVALENTS FOR
 REFERENCE ONLY AND ARE NOT APPROPRIATE FOR USE IN DESIGN.

019407-A

Figure 39. 8-Lead Standard Small Outline Package [SOIC_N]
 Narrow Body
 (R-8)

Dimensions shown in millimeters and (inches)

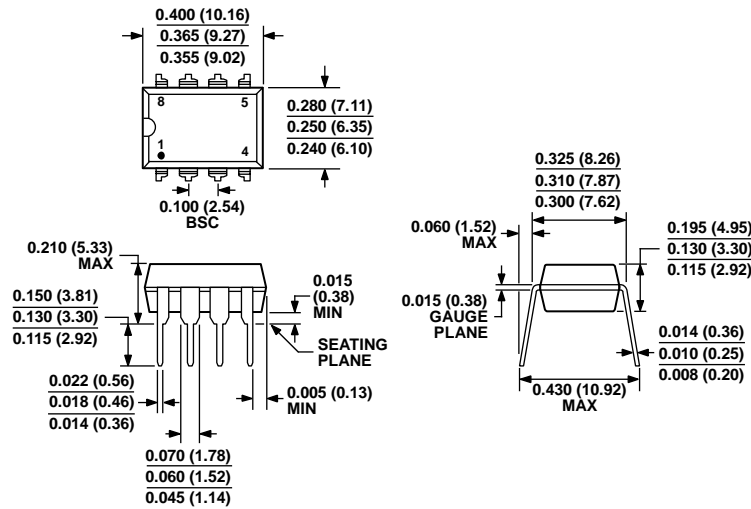

COMPLIANT TO JEDEC STANDARDS MS-001
 CONTROLLING DIMENSIONS ARE IN INCHES; MILLIMETER DIMENSIONS
 (IN PARENTHESES) ARE ROUNDED-OFF INCH EQUIVALENTS FOR
 REFERENCE ONLY AND ARE NOT APPROPRIATE FOR USE IN DESIGN.
 CORNER LEADS MAY BE CONFIGURED AS WHOLE OR HALF LEADS.

070606-A

Figure 40. 8-Lead Plastic Dual-In-Line Package [PDIP]
 (N-8)

Dimensions shown in inches and (millimeters)

ORDERING GUIDE

Model¹	Temperature Range	Package Description	Package Option
AD737ANZ	−40°C to +85°C	8-Lead Plastic Dual In-Line Package [PDIP]	N-8
AD737ARZ	−40°C to +85°C	8-Lead Standard Small Outline Package [SOIC_N]	R-8
AD737JNZ	0°C to 70°C	8-Lead Plastic Dual In-Line Package [PDIP]	N-8
AD737JRZ	0°C to 70°C	8-Lead Standard Small Outline Package [SOIC_N]	R-8
AD737JRZ-R7	0°C to 70°C	8-Lead Standard Small Outline Package [SOIC_N]	R-8
AD737JRZ-RL	0°C to 70°C	8-Lead Standard Small Outline Package [SOIC_N]	R-8
AD737JRZ-5	0°C to 70°C	8-Lead Standard Small Outline Package [SOIC_N]	R-8
AD737JRZ-5-R7	0°C to 70°C	8-Lead Standard Small Outline Package [SOIC_N]	R-8
AD737JRZ-5-RL	0°C to 70°C	8-Lead Standard Small Outline Package [SOIC_N]	R-8
AD737KR-REEL	0°C to 70°C	8-Lead Standard Small Outline Package [SOIC_N]	R-8
AD737KR-REEL7	0°C to 70°C	8-Lead Standard Small Outline Package [SOIC_N]	R-8
AD737KRZ-RL	0°C to 70°C	8-Lead Standard Small Outline Package [SOIC_N]	R-8
AD737KRZ-R7	0°C to 70°C	8-Lead Standard Small Outline Package [SOIC_N]	R-8
AD737-EVALZ		Evaluation Board	

¹ Z = RoHS Compliant Part.

NOTES

NOTES

NOTES