

### FEATURES

- 6.0 V to 15 V supply range**
- Supply current: 15  $\mu$ A maximum**
- Low noise: 15  $\mu$ V p-p typical (0.1 Hz to 10 Hz)**
- High output current: 5 mA**
- Temperature range:  $-40^{\circ}\text{C}$  to  $+125^{\circ}\text{C}$**
- Pin-compatible with the REF02/REF19x**

### APPLICATIONS

- Portable instrumentation**
- Precision reference for 5 V systems**
- ADC and DAC reference**
- Solar-powered applications**
- Loop-current powered instruments**

### GENERAL DESCRIPTION

The ADR293 is a low noise, micropower precision voltage reference that utilizes an XFET® (eXtra implanted junction FET) reference circuit. The XFET architecture offers significant performance improvements over traditional band gap and buried Zener-based references. Improvements include one quarter the voltage noise output of band gap references operating at the same current, very low and ultralinear temperature drift, low thermal hysteresis, and excellent long-term stability.

The ADR293 is a series voltage reference providing stable and accurate output voltage from a 6.0 V supply. Quiescent current is only 15  $\mu$ A maximum, making this device ideal for battery powered instrumentation. Three electrical grades are available offering initial output accuracy of  $\pm 3$  mV,  $\pm 6$  mV, and  $\pm 10$  mV. Temperature coefficients for the three grades are 8 ppm/ $^{\circ}\text{C}$ ,

15 ppm/ $^{\circ}\text{C}$ , and 25 ppm/ $^{\circ}\text{C}$  maximum. Line regulation and load regulation are typically 30 ppm/V and 30 ppm/mA, respectively, maintaining the reference's overall high performance.

The ADR293 is specified over the extended industrial temperature range of  $-40^{\circ}\text{C}$  to  $+125^{\circ}\text{C}$ . This device is available in the 8-lead SOIC and 8-lead TSSOP packages.

### PIN CONFIGURATIONS

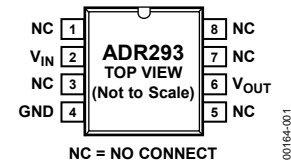

Figure 1. 8-Lead Narrow Body SOIC (R-8)

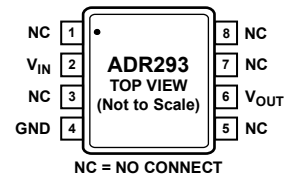

Figure 2. 8-Lead TSSOP (RU-8)

Table 1. ADR29x Products

Device	Output Voltage (V)	Initial Accuracy (%)	Temperature Coefficient (ppm/ $^{\circ}\text{C}$ max)
ADR291	2.500	0.08, 0.12, 0.24	8, 15, 25
ADR292	4.096	0.07, 0.10, 0.15	8, 15, 25
ADR293	5.000	0.06, 0.12, 0.20	8, 15, 25

#### Rev. D

Information furnished by Analog Devices is believed to be accurate and reliable. However, no responsibility is assumed by Analog Devices for its use, nor for any infringements of patents or other rights of third parties that may result from its use. Specifications subject to change without notice. No license is granted by implication or otherwise under any patent or patent rights of Analog Devices. Trademarks and registered trademarks are the property of their respective owners.

**TABLE OF CONTENTS**

Features .....	1	Terminology .....	9
Applications.....	1	Theory of Operation .....	10
Pin Configurations .....	1	Device Power Dissipation Considerations.....	10
General Description .....	1	Basic Voltage Reference Connections .....	10
Revision History .....	2	Noise Performance .....	10
Specifications.....	3	Turn-On Time .....	10
Electrical Specifications.....	3	Applications.....	11
Absolute Maximum Ratings.....	5	Kelvin Connections.....	11
Thermal Resistance .....	5	Voltage Regulator for Portable Equipment.....	11
ESD Caution.....	5	Outline Dimensions .....	12
Typical Performance Characteristics .....	6	Ordering Guide .....	12

**REVISION HISTORY**

**5/11—Rev. C to Rev. D**

Delete Negative Precision Reference Without Precision	
Resistors Section .....	11
Delete Figure 23 and Figure 24, Renumbered Sequentially.....	11

**9/10—Rev. B to Rev. C**

Changes to Table 2 and Table 3.....	3
Changes to Table 4.....	4
Changes to Figure 10, Figure 11, Figure 13.....	7
Changes to Captions for Figure 17 to Figure 19.....	8

**6/07—Rev. A to Rev. B**

Updated Format.....	Universal
Changes to Table 1.....	1
Updated Outline Dimensions.....	13
Changes to Ordering Guide.....	13

**3/01—Rev. 0 to Rev. A**

## SPECIFICATIONS

### ELECTRICAL SPECIFICATIONS

$V_S = 6.0\text{ V}$ ,  $T_A = 25^\circ\text{C}$ , unless otherwise noted.

Table 2.

Parameter	Symbol	Conditions	Min	Typ	Max	Unit
OUTPUT VOLTAGE	$V_{OUT}$	$I_{OUT} = 0\text{ mA}$				
E Grade			4.997	5.000	5.003	V
F Grade			4.994	5.000	5.006	V
G Grade			4.990	5.000	5.010	V
INITIAL ACCURACY		$I_{OUT} = 0\text{ mA}$				
E Grade			-3		+3	mV
					0.06	%
F Grade			-6		+6	mV
					0.12	%
G Grade			-10		+10	mV
					0.20	%
LINE REGULATION	$\Delta V_{OUT} / \Delta V_{IN}$	6.0 V to 15 V, $I_{OUT} = 0\text{ mA}$				
E, F Grades				30	100	ppm/V
G Grade				40	150	ppm/V
LOAD REGULATION	$\Delta V_{OUT} / \Delta I_{LOAD}$	$V_S = 6.0\text{ V}$ , $I_{OUT} = 0\text{ mA}$ to 5 mA				
E, F Grades				30	100	ppm/mA
G Grade				40	150	ppm/mA
LONG-TERM STABILITY	$\Delta V_{OUT}$	After 1000 hours of operation @ 125°C		50		ppm
VOLTAGE NOISE	$e_{N\text{ p-p}}$	$f = 0.1\text{ Hz}$ to 10 Hz		15		$\mu\text{V p-p}$
VOLTAGE NOISE DENSITY	$e_N$	$f = 1\text{ kHz}$		640		$\text{nV}/\sqrt{\text{Hz}}$

$V_S = 6.0\text{ V}$ ,  $T_A = -25^\circ\text{C}$  to  $+85^\circ\text{C}$ , unless otherwise noted.

Table 3.

Parameter	Symbol	Conditions	Min	Typ	Max	Unit
TEMPERATURE COEFFICIENT	$TCV_{OUT}$	$I_{OUT} = 0\text{ mA}$				
E Grade				3	8	ppm/°C
F Grade				5	15	ppm/°C
G Grade				10	25	ppm/°C
LINE REGULATION	$\Delta V_{OUT} / \Delta V_{IN}$	6.0 V to 15 V, $I_{OUT} = 0\text{ mA}$				
E, F Grades				35	150	ppm/V
G Grade				50	200	ppm/V
LOAD REGULATION	$\Delta V_{OUT} / \Delta I_{LOAD}$	$V_S = 6.0\text{ V}$ , $I_{OUT} = 0\text{ mA}$ to 5 mA				
E, F Grades				20	150	ppm/mA
G Grade				30	200	ppm/mA

# ADR293

$V_S = 6.0\text{ V}$ ,  $T_A = -40^\circ\text{C}$  to  $+125^\circ\text{C}$ , unless otherwise noted.

**Table 4.**

Parameter	Symbol	Conditions	Min	Typ	Max	Unit
TEMPERATURE COEFFICIENT	$TCV_{OUT}$	$I_{OUT} = 0\text{ mA}$				
E Grade			3	10	ppm/ $^\circ\text{C}$	
F Grade			5	20	ppm/ $^\circ\text{C}$	
G Grade			10	30	ppm/ $^\circ\text{C}$	
LINE REGULATION	$\Delta V_{OUT}/\Delta V_{IN}$	6.0 V to 15 V, $I_{OUT} = 0\text{ mA}$				
E, F Grades			40	200	ppm/V	
G Grade			70	250	ppm/V	
LOAD REGULATION	$\Delta V_{OUT}/\Delta I_{LOAD}$	$V_S = 6.0\text{ V}$ , $I_{OUT} = 0\text{ mA}$ to 5 mA				
E, F Grades			20	200	ppm/mA	
G Grade			30	300	ppm/mA	
SUPPLY CURRENT	$I_S$	@ 25 $^\circ\text{C}$				
			11	15	$\mu\text{A}$	
			15	20	$\mu\text{A}$	
THERMAL HYSTERESIS	$V_{OUT-HYS}$	8-lead SOIC_N		72		ppm
			8-lead TSSOP		157	

## ABSOLUTE MAXIMUM RATINGS

Table 5.

Parameter	Rating
Supply Voltage	18 V
Output Short-Circuit Duration to GND	Indefinite
Storage Temperature Range	-65°C to +150°C
Operating Temperature Range	-40°C to +125°C
Junction Temperature Range	-65°C to +150°C
Lead Temperature (Soldering, 60 sec)	300°C

Stresses above those listed under Absolute Maximum Ratings may cause permanent damage to the device. This is a stress rating only; functional operation of the device at these or any other conditions above those indicated in the operational section of this specification is not implied. Exposure to absolute maximum rating conditions for extended periods may affect device reliability.

## THERMAL RESISTANCE

$\theta_{JA}$  is specified for worst-case conditions; that is,  $\theta_{JA}$  is specified for the device in socket testing. In practice,  $\theta_{JA}$  is specified for the device soldered in a circuit board.

Table 6. Thermal Resistance

Package Type	$\theta_{JA}$	$\theta_{JC}$	Unit
8-Lead SOIC_N (R-8)	158	43	°C/W
8-Lead TSSOP (RU-8)	240	43	°C/W

## ESD CAUTION



### ESD (electrostatic discharge) sensitive device.

Charged devices and circuit boards can discharge without detection. Although this product features patented or proprietary protection circuitry, damage may occur on devices subjected to high energy ESD. Therefore, proper ESD precautions should be taken to avoid performance degradation or loss of functionality.

## TYPICAL PERFORMANCE CHARACTERISTICS

$T_A = 25^\circ\text{C}$ , unless otherwise noted.

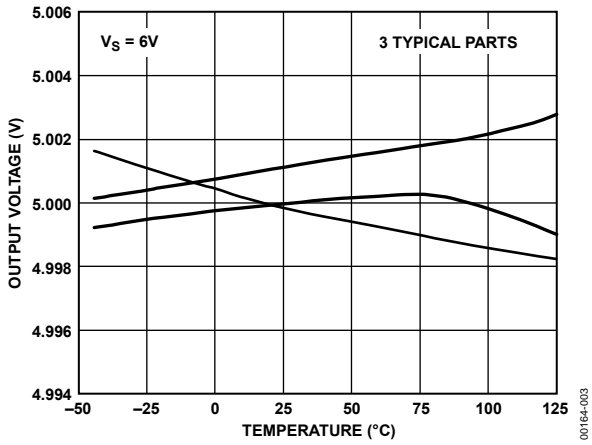

Figure 3.  $V_{OUT}$  vs. Temperature

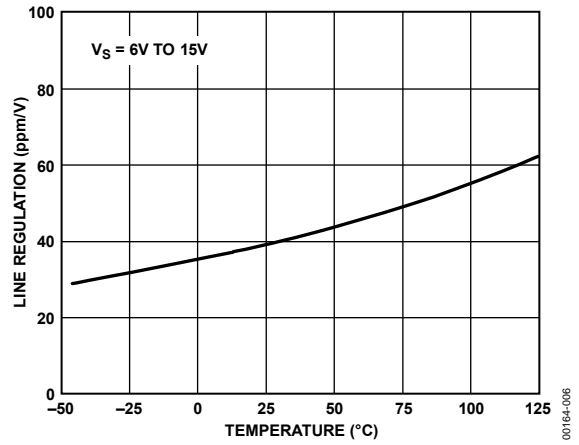

Figure 6. Line Regulation vs. Temperature

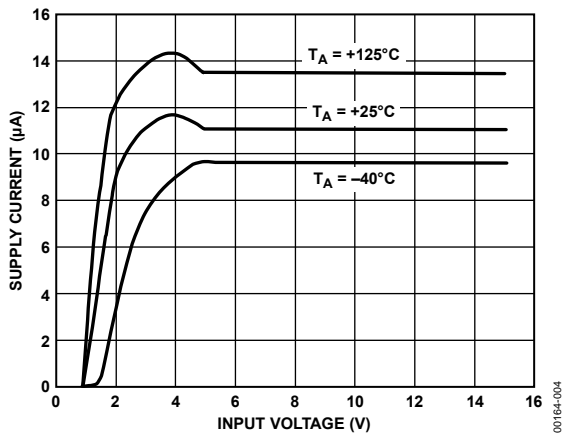

Figure 4. Supply Current vs. Input Voltage

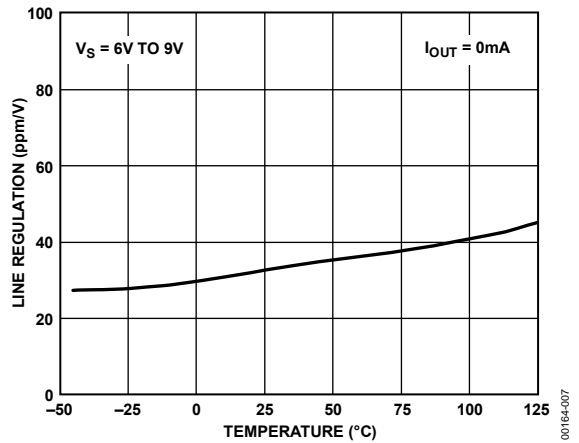

Figure 7. Line Regulation vs. Temperature

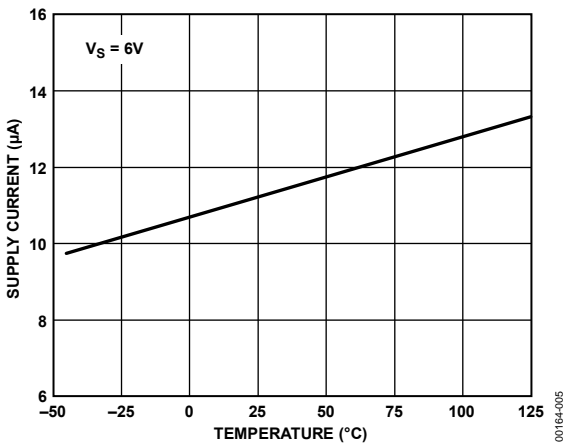

Figure 5. Supply Current vs. Temperature

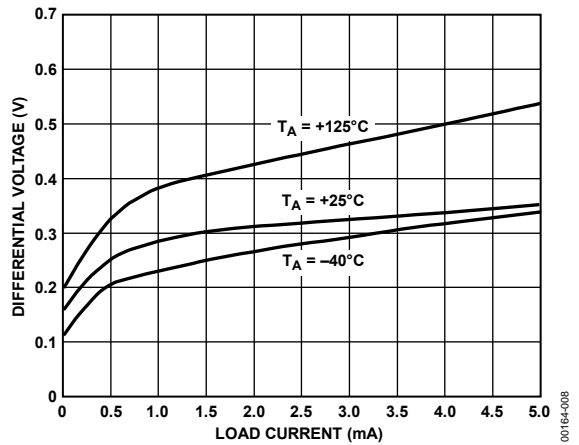

Figure 8. Minimum Input/Output Voltage Differential vs. Load Current

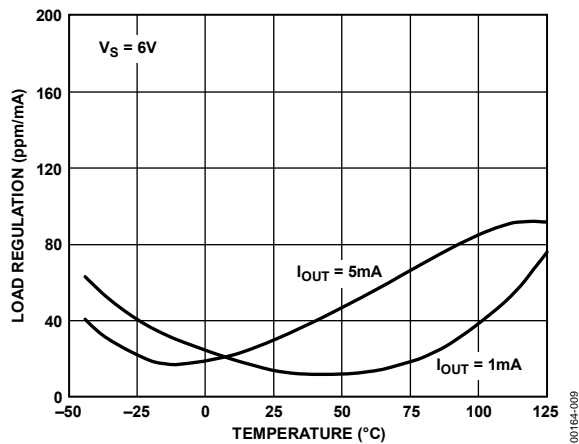

Figure 9. Load Regulation vs. Temperature

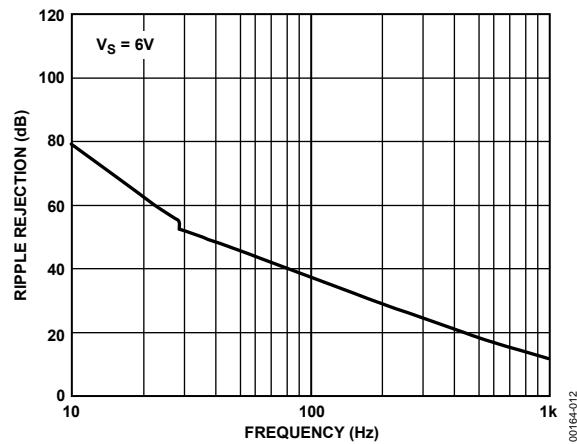

Figure 12. Ripple Rejection vs. Frequency

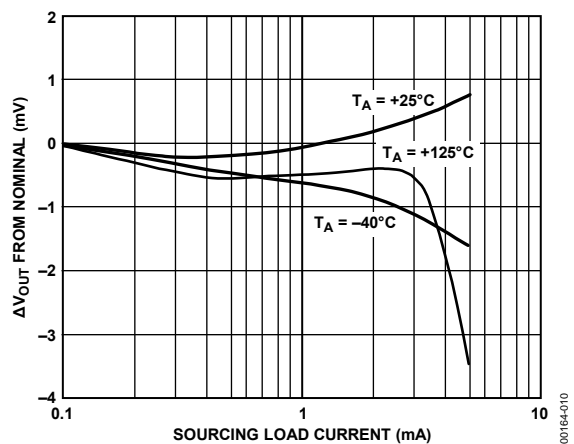

Figure 10.  $\Delta V_{OUT}$  from Nominal vs. Load Current

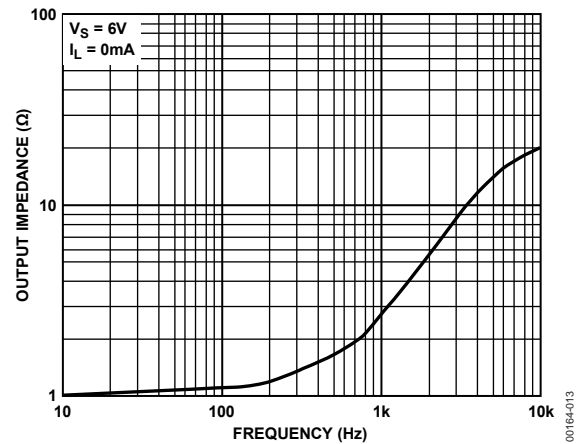

Figure 13. Output Impedance vs. Frequency

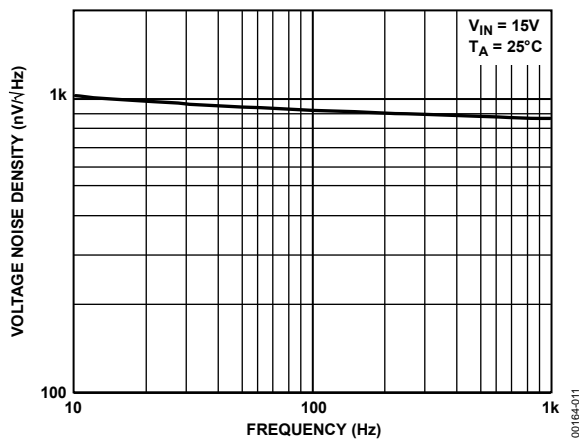

Figure 11. Voltage Noise Density vs. Frequency

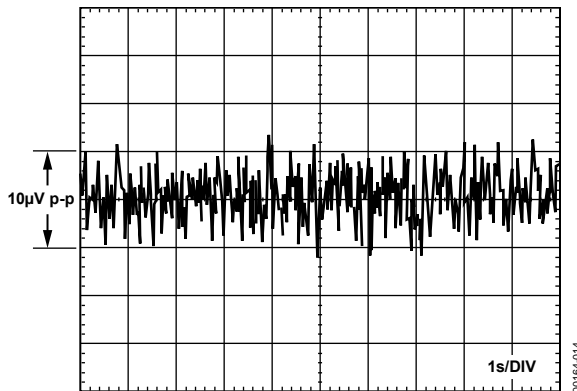

Figure 14. 0.1 Hz to 10 Hz Noise

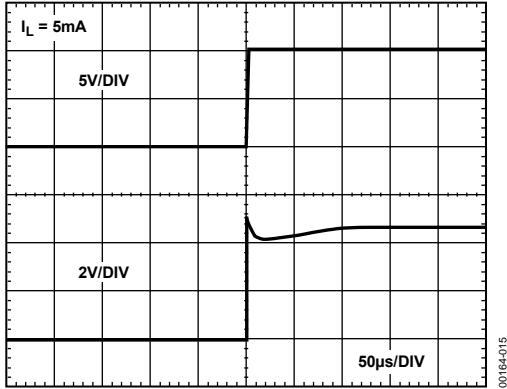

Figure 15. Turn-On Time

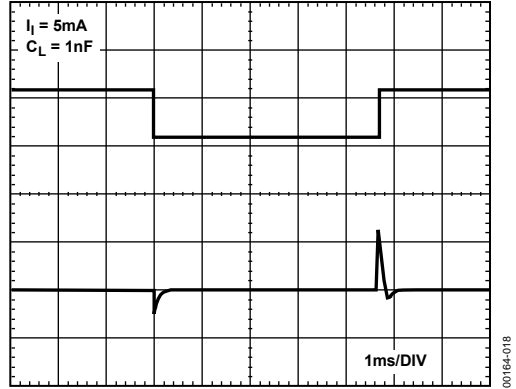

Figure 18. Load Transient Response

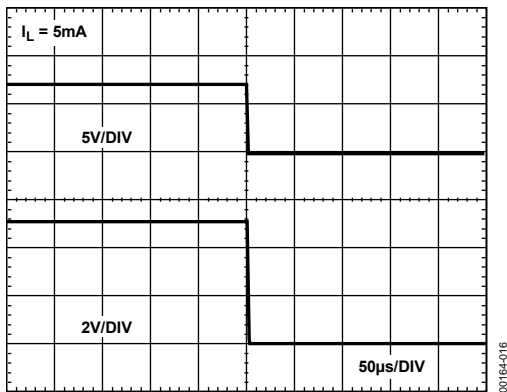

Figure 16. Turn-Off Time

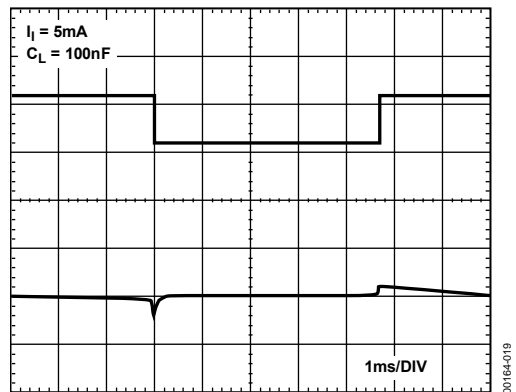

Figure 19. Load Transient Response

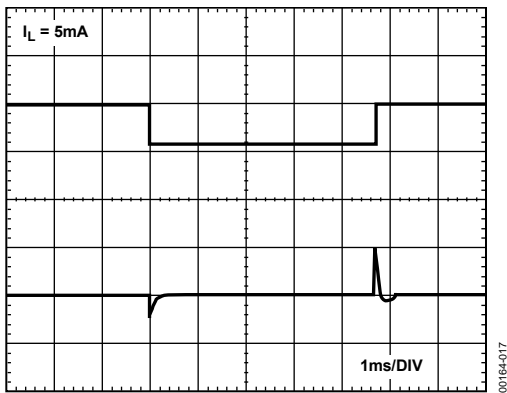

Figure 17. Load Transient Response

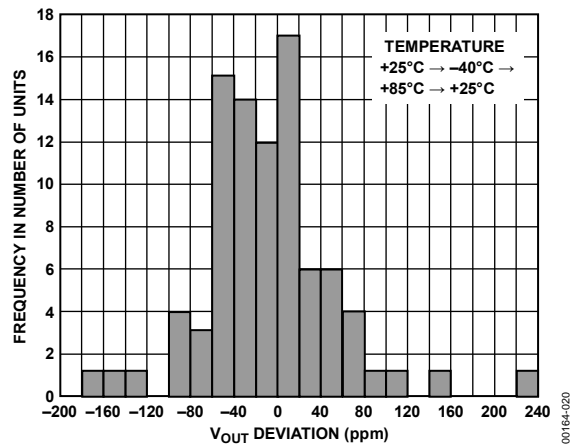

Figure 20. Typical Hysteresis for the ADR29x Product



## TERMINOLOGY

### Line Regulation

The change in output voltage due to a specified change in input voltage. It includes the effects of self-heating. Line regulation is expressed in percent per volt, parts per million per volt, or microvolts per volt change in input voltage.

### Load Regulation

The change in output voltage due to a specified change in load current. It includes the effects of self-heating. Load regulation is expressed in microvolts per milliampere, parts per million per milliampere, or ohms of dc output resistance.

### Long-Term Stability

Typical shift of output voltage of 25°C on a sample of parts subjected to high temperature operating life test of 1000 hours at 125°C.

$$\Delta V_{OUT} = V_{OUT}(t_0) - V_{OUT}(t_1)$$

$$\Delta V_{OUT} [\text{ppm}] = \frac{V_{OUT}(t_0) - V_{OUT}(t_1)}{V_{OUT}(t_0)} \times 10^6$$

where:

$V_{OUT}(t_0)$  =  $V_{OUT}$  at 25°C at time 0.

$V_{OUT}(t_1)$  =  $V_{OUT}$  at 25°C after 1000 hours operation at 125°C.

### NC = No Connect

There are in fact connections at NC pins, which are reserved for manufacturing purposes. Users should not connect anything at NC pins.

### Temperature Coefficient

The change of output voltage over the operating temperature change and normalized by the output voltage at 25°C, expressed in ppm/°C.

$$TCV_{OUT} [\text{ppm}/^\circ\text{C}] = \frac{V_{OUT}(T_2) - V_{OUT}(T_1)}{V_{OUT}(25^\circ\text{C}) \times (T_2) - T_1} \times 10^6$$

where:

$V_{OUT}(25^\circ\text{C})$  =  $V_{OUT}$  at 25°C.

$V_{OUT}(T_1)$  =  $V_{OUT}$  at Temperature 1.

$V_{OUT}(T_2)$  =  $V_{OUT}$  at Temperature 2.

### Thermal Hysteresis

Thermal hysteresis is defined as the change of output voltage after the device is cycled through temperatures from +25°C to -40°C to +85°C and back to +25°C. This is a typical value from a sample of parts put through such a cycle.

$$V_{OUT-HYS} = V_{OUT}(25^\circ\text{C}) - V_{OUT-TC}$$

$$V_{OUT-HYS} [\text{ppm}] = \frac{V_{OUT}(25^\circ\text{C}) - V_{OUT-TC}}{V_{OUT}(25^\circ\text{C})} \times 10^6$$

where:

$V_{OUT}(25^\circ\text{C})$  =  $V_{OUT}$  at 25°C.

$V_{OUT-TC}$  =  $V_{OUT}(25^\circ\text{C})$  after temperature cycle at +25°C to -40°C to +85°C and back to +25°C.

## THEORY OF OPERATION

The ADR293 uses a new reference generation technique known as XFET, which yields a reference with low noise, low supply current, and very low thermal hysteresis.

The core of the XFET reference consists of two junction field effect transistors, one of which has an extra channel implant to raise its pinch-off voltage. By running the two JFETs at the same drain current, the difference in pinch-off voltage can be amplified and used to form a highly stable voltage reference. The intrinsic reference voltage is around 0.5 V with a negative temperature coefficient of about -120 ppm/K. This slope is essentially locked to the dielectric constant of silicon and can be closely compensated by adding a correction term generated in the same fashion as the proportional-to-temperature (PTAT) term used to compensate band gap references. The big advantage over a band gap reference is that the intrinsic temperature coefficient is some 30 times lower (therefore, less correction is needed) and this results in much lower noise, because most of the noise of a band gap reference comes from the temperature compensation circuitry.

The simplified schematic in Figure 21 shows the basic topology of the ADR293. The temperature correction term is provided by a current source with value designed to be proportional to absolute temperature. The general equation is

$$V_{OUT} = \Delta V_P \left( \frac{R1 + R2 + R3}{R1} \right) + (I_{PTAT})(R3)$$

where:

$\Delta V_P$  is the difference in pinch-off voltage between the two FETs.  
 $I_{PTAT}$  is the positive temperature coefficient correction current.

The process used for the XFET reference also features vertical NPN and PNP transistors, the latter of which are used as output devices to provide a very low dropout voltage.

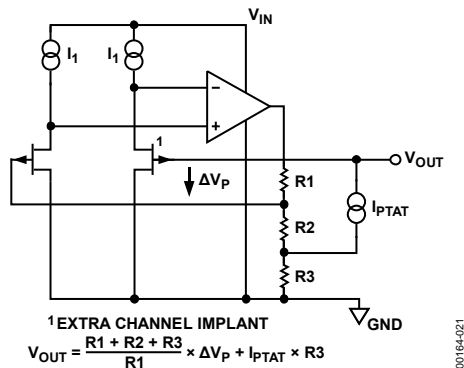

Figure 21. Simplified Schematic

## DEVICE POWER DISSIPATION CONSIDERATIONS

The ADR293 is guaranteed to deliver load currents to 5 mA with an input voltage that ranges from 5.5 V to 15 V. When this device is used in applications with large input voltages, care should be exercised to avoid exceeding the published specifications for maximum power dissipation or junction temperature that could result in premature device failure. The following formula should be used to calculate a device's maximum junction temperature or dissipation:

$$P_D = \frac{T_J - T_A}{\theta_{JA}}$$

where:

$T_J$  and  $T_A$  are the junction temperature and ambient temperature, respectively.

$P_D$  is the device power dissipation.

$\theta_{JA}$  is the device package thermal resistance.

## BASIC VOLTAGE REFERENCE CONNECTIONS

References, in general, require a bypass capacitor connected from the  $V_{OUT}$  pin to the GND pin. The circuit in Figure 22 illustrates the basic configuration for the ADR293. Note that the decoupling capacitors are not required for circuit stability.

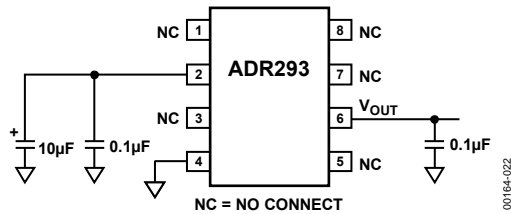

Figure 22. Basic Voltage Reference Configuration

## NOISE PERFORMANCE

The noise generated by the ADR293 is typically less than 15 µV p-p over the 0.1 Hz to 10 Hz band. The noise measurement is made with a band-pass filter made of a 2-pole high-pass filter with a corner frequency at 0.1 Hz and a 2-pole low-pass filter with a corner frequency at 10 Hz.

## TURN-ON TIME

Upon application of power (cold start), the time required for the output voltage to reach its final value within a specified error band is defined as the turn-on settling time. Two components normally associated with this are the time for the active circuits to settle and the time for the thermal gradients on the chip to stabilize. Figure 15 shows the typical turn-on time for the ADR293.

## APPLICATIONS

### KELVIN CONNECTIONS

In many portable instrumentation applications where PC board cost and area go hand-in-hand, circuit interconnects are very often of dimensionally minimum width. These narrow lines can cause large voltage drops if the voltage reference is required to provide load currents to various functions. In fact, a circuit's interconnects can exhibit a typical line resistance of 0.45 mΩ/square (1 oz. Cu, for example). Force and sense connections, also referred to as Kelvin connections, offer a convenient method of eliminating the effects of voltage drops in circuit wires. Load currents flowing through wiring resistance produce an error ( $V_{ERROR} = R \times I_L$ ) at the load. However, the Kelvin connection in Figure 23 overcomes the problem by including the wiring resistance within the forcing loop of the op amp. Because the op amp senses the load voltage, op amp loop control forces the output to compensate for the wiring error and to produce the correct voltage at the load.

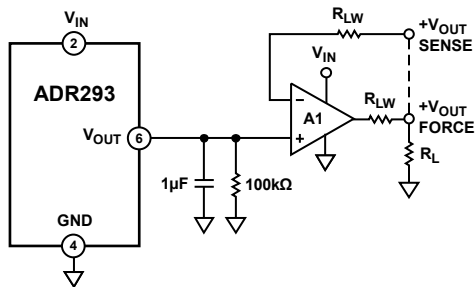

Figure 23. Advantage of Kelvin Connection

00164-025

### VOLTAGE REGULATOR FOR PORTABLE EQUIPMENT

The ADR293 is ideal for providing a stable, low cost, and low power reference voltage in portable equipment power supplies. Figure 24 shows how the ADR293 can be used in a voltage regulator that not only has low output noise (as compared to switch mode design) and low power, but also a very fast recovery after current surges. Some precautions should be taken in the selection of the output capacitors. Too high an ESR (effective series resistance) could endanger the stability of the circuit. A solid tantalum capacitor, 16 V or higher, and an aluminum electrolytic capacitor, 10 V or higher, are recommended for C1 and C2, respectively. In addition, the path from the ground side of C1 and C2 to the ground side of R1 should be kept as short as possible.

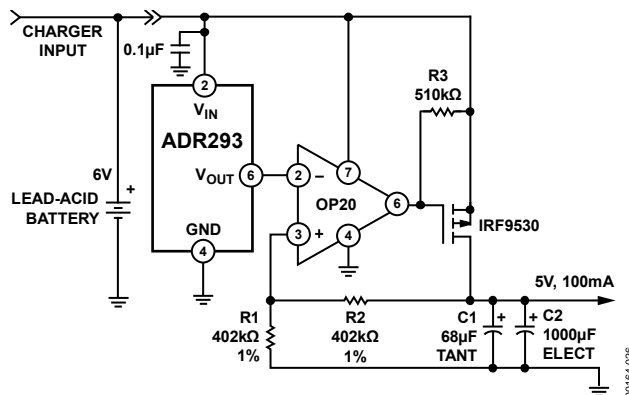
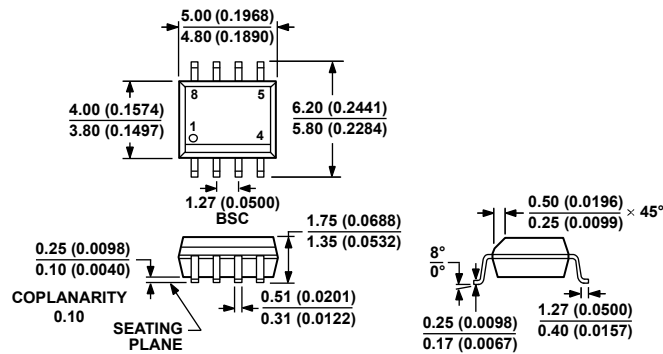

Figure 24. Voltage Regulator for Portable Equipment

00164-026

## OUTLINE DIMENSIONS



COMPLIANT TO JEDEC STANDARDS MS-012-AA  
 CONTROLLING DIMENSIONS ARE IN MILLIMETERS; INCH DIMENSIONS  
 (IN PARENTHESES) ARE ROUNDED-OFF MILLIMETER EQUIVALENTS FOR  
 REFERENCE ONLY AND ARE NOT APPROPRIATE FOR USE IN DESIGN.

012407-A

Figure 25. 8-Lead Standard Small Outline Package [SOIC\_N]  
 Narrow Body  
 (R-8)

Dimensions shown in millimeters and (inches)

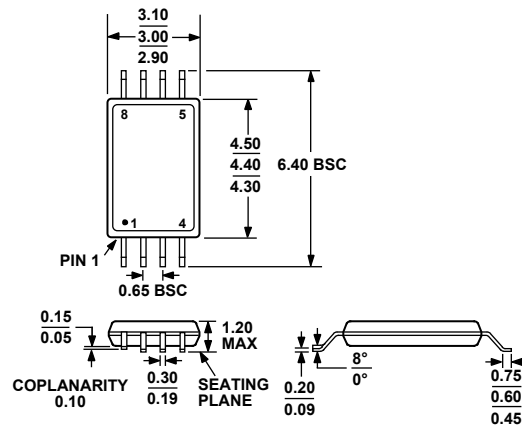

COMPLIANT TO JEDEC STANDARDS MO-153-AA

Figure 26. 8-Lead Thin Shrink Small Outline Package [TSSOP]  
 (RU-8)

Dimensions shown in millimeters

## ORDERING GUIDE

Model <sup>1</sup>	Output Voltage (V)	Initial Accuracy (%)	Temperature Coefficient (ppm/°C max)	Temperature Range	Package Description	Package Option	Ordering Quantity
ADR293ERZ	5.00	0.06	8	-40°C to +125°C	8-Lead SOIC_N	R-8	98
ADR293ERZ-REEL	5.00	0.06	8	-40°C to +125°C	8-Lead SOIC_N	R-8	2,500
ADR293GRZ	5.00	0.20	25	-40°C to +125°C	8-Lead SOIC_N	R-8	98
ADR293GRZ-REEL7	5.00	0.20	25	-40°C to +125°C	8-Lead SOIC_N	R-8	1,000
ADR293GRUZ	5.00	0.20	25	-40°C to +125°C	8-Lead TSSOP	RU-8	96
ADR293GRUZ-REEL	5.00	0.20	25	-40°C to +125°C	8-Lead TSSOP	RU-8	2,500
ADR293GRUZ-REEL7	5.00	0.20	25	-40°C to +125°C	8-Lead TSSOP	RU-8	1,000

<sup>1</sup> Z = RoHS Compliant Part.