

## 1.8-V OPERATIONAL AMPLIFIERS WITH RAIL-TO-RAIL INPUT AND OUTPUT

Check for Samples: [LMV932 DUAL](#), [LMV934 QUAD](#), [LMV931 SINGLE](#)

### FEATURES

- 1.8-V, 2.7-V, and 5-V Specifications
- Rail-to-Rail Output Swing
  - 600-Ω Load . . . 80 mV From Rail
  - 2-kΩ Load . . . 30 mV From Rail
- $V_{ICR}$  . . . 200 mV Beyond Rails
- Gain Bandwidth . . . 1.4 MHz
- Supply Current . . . 100  $\mu$ A/Amplifier
- Max  $V_{IO}$  . . . 4 mV
- Space-Saving Packages
  - LMV931: SOT-23 and SC-70
  - LMV932: MSOP and SOIC
  - LMV934: SOIC and TSSOP

### APPLICATIONS

- Industrial (Utility/Energy Metering)
- Automotive
- Communications (Optical Telecom, Data/Voice Cable Modems)
- Consumer Electronics (PDAs, PCs, CDR/W, Portable Audio)
- Supply-Current Monitoring
- Battery Monitoring

LMV931 . . . DBV (SOT-23-5) OR DCK (SC-70) PACKAGE  
(TOP VIEW)

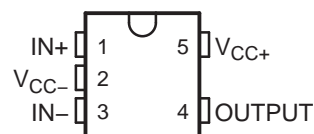

LMV932 . . . D (SOIC) OR  
DGK (VSSOP/MSOP) PACKAGE  
(TOP VIEW)

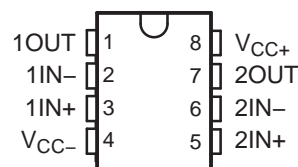

LMV934 . . . D (SOIC) OR PW (TSSOP) PACKAGE  
(TOP VIEW)

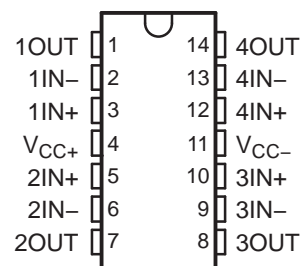

### DESCRIPTION/ORDERING INFORMATION



Please be aware that an important notice concerning availability, standard warranty, and use in critical applications of Texas Instruments semiconductor products and disclaimers thereto appears at the end of this data sheet.

**ORDERING INFORMATION**

| T <sub>A</sub> | PACKAGE <sup>(1)</sup> |                  | ORDERABLE PART NUMBER | TOP-SIDE MARKING <sup>(2)</sup> |         |
|----------------|------------------------|------------------|-----------------------|---------------------------------|---------|
| -40°C to 125°C | Single                 | SOT-23 – DBV     | Reel of 3000          | LMV931IDBVR                     | RBB_    |
|                |                        |                  | Reel of 250           | LMV931IDBVT                     | PREVIEW |
|                |                        | SC-70 – DCK      | Reel of 3000          | LMV931IDCKR                     | RB_     |
|                |                        |                  | Reel of 250           | LMV931IDCKT                     | PREVIEW |
|                | Dual                   | MSOP/VSSOP – DGK | Reel of 2500          | LMV932IDGKR                     | RD_     |
|                |                        |                  | Reel of 250           | LMV932IDGKT                     | PREVIEW |
|                |                        | SOIC – D         | Tube of 75            | LMV932ID                        | MV932I  |
|                |                        |                  | Reel of 2500          | LMV932IDR                       |         |
|                | Quad                   | SOIC – D         | Tube of 50            | LMV934ID                        | LMV934I |
|                |                        |                  | Reel of 2500          | LMV934IDR                       |         |
|                |                        | TSSOP – PW       | Tube of 90            | LMV934IPW                       | MV934I  |
|                |                        |                  | Reel of 2000          | LMV934IPWR                      |         |

(1) Package drawings, standard packing quantities, thermal data, symbolization, and PCB design guidelines are available at [www.ti.com/sc/package](http://www.ti.com/sc/package).

(2) DBV/DCK/DGK: The actual top-side marking has one additional character that designates the assembly/test site.

**DESCRIPTION/ORDERING INFORMATION (CONTINUED)**

The LMV93x devices are low-voltage low-power operational amplifiers that are well suited for today's low-voltage and/or portable applications. Specified for operation of 1.8 V to 5 V, they can be used in portable applications that are powered from a single-cell Li-ion or two-cell batteries. They have rail-to-rail input and output capability for maximum signal swings in low-voltage applications. The LMV93x input common-mode voltage extends 200 mV beyond the rails for increased flexibility. The output can swing rail-to-rail unloaded and typically can reach 80 mV from the rails, while driving a 600-Ω load (at 1.8-V operation).

During 1.8-V operation, the devices typically consume a quiescent current of 103 μA per channel, and yet they are able to achieve excellent electrical specifications, such as 101-dB open-loop DC gain and 1.4-MHz gain bandwidth. Furthermore, the amplifiers offer good output drive characteristics, with the ability to drive a 600-Ω load and 1000-pF capacitance with minimal ringing.

The LMV93x devices are offered in the latest packaging technology to meet the most demanding space-constraint applications. The LMV931 is offered in standard SOT-23 and SC-70 packages. The LMV932 is available in the traditional MSOP and SOIC packages. The LMV934 is available in the traditional SOIC and TSSOP packages.

The LMV93x devices are characterized for operation from -40°C to 125°C, making the part universally suited for commercial, industrial, and automotive applications.

Figure 1. SIMPLIFIED SCHEMATIC

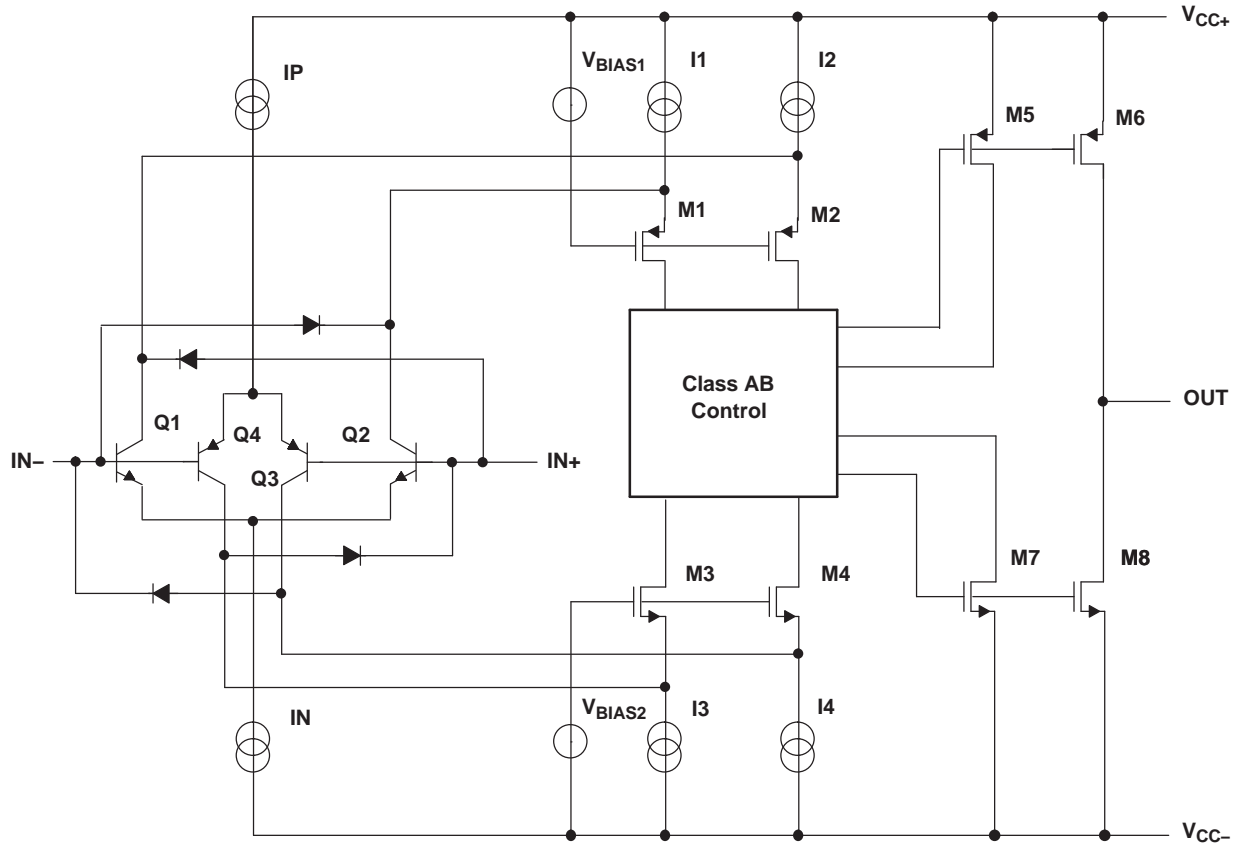

### Absolute Maximum Ratings<sup>(1)</sup>

over free-air temperature range (unless otherwise noted)

|                                                                                    |                                              | MIN                | MAX             | UNIT |
|------------------------------------------------------------------------------------|----------------------------------------------|--------------------|-----------------|------|
| $V_{CC+} - V_{CC-}$                                                                | Supply voltage <sup>(2)</sup>                |                    | 5.5             | V    |
| $V_{ID}$                                                                           | Differential input voltage <sup>(3)</sup>    | Supply voltage     |                 |      |
| $V_I$                                                                              | Input voltage range, either input            | $V_{CC-} - 0.2$    | $V_{CC+} + 0.2$ | V    |
| Duration of output short circuit (one amplifier) to $V_{CC\pm}$ <sup>(4) (5)</sup> |                                              | Unlimited          |                 |      |
| $\theta_{JA}$                                                                      | Package thermal impedance <sup>(5) (6)</sup> | D package (8 pin)  |                 | °C/W |
|                                                                                    |                                              | D package (14 pin) |                 |      |
|                                                                                    |                                              | DBV package        |                 |      |
|                                                                                    |                                              | DCK package        |                 |      |
|                                                                                    |                                              | DGK package        |                 |      |
|                                                                                    |                                              | PW package         |                 |      |
| $T_J$                                                                              | Operating virtual junction temperature       |                    | 150             | °C   |
| $T_{stg}$                                                                          | Storage temperature range                    | -65                | 150             | °C   |

- (1) Stresses beyond those listed under *Absolute Maximum Ratings* may cause permanent damage to the device. These are stress ratings only, and functional operation of the device at these or any other conditions beyond those indicated under *Recommended Operating Conditions* is not implied. Exposure to absolute-maximum-rated conditions for extended periods may affect device reliability.
- (2) All voltage values (except differential voltages and  $V_{CC}$  specified for the measurement of  $I_{OS}$ ) are with respect to the network GND.
- (3) Differential voltages are at IN+ with respect to IN-.
- (4) Applies to both single-supply and split-supply operation. Continuous short-circuit operation at elevated ambient temperature can result in exceeding the maximum allowed junction temperature of 150°C. Output currents in excess of 45 mA over long term may adversely affect reliability.
- (5) Maximum power dissipation is a function of  $T_J(\text{max})$ ,  $\theta_{JA}$ , and  $T_A$ . The maximum allowable power dissipation at any allowable ambient temperature is  $P_D = (T_J(\text{max}) - T_A)/\theta_{JA}$ . Operating at the absolute maximum  $T_J$  of 150°C can affect reliability.
- (6) The package thermal impedance is calculated in accordance with JESD 51-7.

### Recommended Operating Conditions

|          |                                        | MIN | MAX | UNIT |
|----------|----------------------------------------|-----|-----|------|
| $V_{CC}$ | Supply voltage ( $V_{CC+} - V_{CC-}$ ) | 1.8 | 5   | V    |
| $T_A$    | Operating free-air temperature         | -40 | 125 | °C   |

### ESD Protection

|                  | TYP  | UNIT |
|------------------|------|------|
| Human-Body Model | 2000 | V    |
| Machine Model    | 200  | V    |

## Electrical Characteristics

$V_{CC+} = 1.8\text{ V}$ ,  $V_{CC-} = 0\text{ V}$ ,  $V_{IC} = V_{CC+}/2$ ,  $V_O = V_{CC+}/2$ , and  $R_L > 1\text{ M}\Omega$  (unless otherwise noted)

| PARAMETER                                  |                                                         | TEST CONDITIONS                                                                    |                                                                              | $T_A$                                      | MIN                                   | TYP             | MAX             | UNIT                         |    |
|--------------------------------------------|---------------------------------------------------------|------------------------------------------------------------------------------------|------------------------------------------------------------------------------|--------------------------------------------|---------------------------------------|-----------------|-----------------|------------------------------|----|
| $V_{IO}$                                   | Input offset voltage                                    | LMV931 (single)                                                                    |                                                                              | 25°C                                       |                                       | 1               | 4               | mV                           |    |
|                                            |                                                         |                                                                                    |                                                                              | Full range                                 |                                       |                 | 6               |                              |    |
|                                            |                                                         | LMV932 (dual), LMV934 (quad)                                                       |                                                                              | 25°C                                       |                                       | 1               | 5.5             |                              |    |
|                                            |                                                         |                                                                                    |                                                                              | Full range                                 |                                       |                 | 7.5             |                              |    |
| $\alpha_{V_{IO}}$                          | Average temperature coefficient of input offset voltage |                                                                                    |                                                                              | 25°C                                       |                                       | 5.5             |                 | $\mu\text{V}/^\circ\text{C}$ |    |
| $I_{IB}$                                   | Input bias current                                      | $V_{IC} = V_{CC+} - 0.8\text{ V}$                                                  |                                                                              | 25°C                                       |                                       | 15              | 35              | nA                           |    |
|                                            |                                                         |                                                                                    |                                                                              | 25°C                                       |                                       |                 | 65              |                              |    |
|                                            |                                                         |                                                                                    |                                                                              | Full range                                 |                                       |                 | 75              |                              |    |
| $I_{IO}$                                   | Input offset current                                    |                                                                                    |                                                                              | 25°C                                       |                                       | 13              | 25              | nA                           |    |
|                                            |                                                         |                                                                                    |                                                                              | Full range                                 |                                       |                 | 40              |                              |    |
| $I_{CC}$                                   | Supply current (per channel)                            |                                                                                    |                                                                              | 25°C                                       |                                       | 103             | 185             | $\mu\text{A}$                |    |
|                                            |                                                         |                                                                                    |                                                                              | Full range                                 |                                       |                 | 205             |                              |    |
| CMRR                                       | Common-mode rejection ratio                             | $0 \leq V_{IC} \leq 0.6\text{ V}$ , $1.4\text{ V} \leq V_{IC} \leq 1.8\text{ V}$   |                                                                              | 25°C                                       | 60                                    | 78              | dB              |                              |    |
|                                            |                                                         |                                                                                    |                                                                              | $-40^\circ\text{C}$ to $85^\circ\text{C}$  | 55                                    |                 |                 |                              |    |
|                                            |                                                         | $0.2 \leq V_{IC} \leq 0.6\text{ V}$ , $1.4\text{ V} \leq V_{IC} \leq 1.6\text{ V}$ | $-40^\circ\text{C}$ to $125^\circ\text{C}$                                   | 55                                         |                                       |                 |                 |                              |    |
| $k_{SVR}$                                  | Supply-voltage rejection ratio                          | $1.8\text{ V} \leq V_{CC+} \leq 5\text{ V}$ , $V_{IC} = 0.5\text{ V}$              |                                                                              | 25°C                                       | 75                                    | 100             | dB              |                              |    |
|                                            |                                                         |                                                                                    |                                                                              | Full range                                 | 70                                    |                 |                 |                              |    |
| $V_{ICR}$                                  | Common-mode input voltage range                         | CMRR $\geq 50\text{ dB}$                                                           |                                                                              | 25°C                                       | $V_{CC-} - 0.2$                       | $-0.2$ to $2.1$ | $V_{CC+} + 0.2$ | V                            |    |
|                                            |                                                         |                                                                                    |                                                                              | $-40^\circ\text{C}$ to $85^\circ\text{C}$  | $V_{CC-}$                             |                 | $V_{CC+}$       |                              |    |
|                                            |                                                         |                                                                                    |                                                                              | $-40^\circ\text{C}$ to $125^\circ\text{C}$ | $V_{CC-} + 0.2$                       |                 | $V_{CC+} - 0.2$ |                              |    |
| $A_V$                                      | Large-signal voltage gain                               | LMV931                                                                             | $V_O = 0.2\text{ V}$ to $1.6\text{ V}$ ,<br>$V_{IC} = 0.5\text{ V}$          | $R_L = 600\ \Omega$ to $0.9\text{ V}$      | 25°C                                  | 77              | 101             | dB                           |    |
|                                            |                                                         |                                                                                    |                                                                              |                                            | Full range                            | 73              |                 |                              |    |
|                                            |                                                         |                                                                                    |                                                                              | $R_L = 2\text{ k}\Omega$ to $0.9\text{ V}$ | 25°C                                  | 80              | 105             |                              |    |
|                                            |                                                         |                                                                                    |                                                                              |                                            | Full range                            | 75              |                 |                              |    |
|                                            |                                                         |                                                                                    |                                                                              | LMV932, LMV934                             | $R_L = 600\ \Omega$ to $0.9\text{ V}$ | 25°C            | 75              |                              | 90 |
|                                            |                                                         |                                                                                    |                                                                              |                                            |                                       | Full range      | 72              |                              |    |
| $R_L = 2\text{ k}\Omega$ to $0.9\text{ V}$ | 25°C                                                    | 78                                                                                 | 100                                                                          |                                            |                                       |                 |                 |                              |    |
|                                            | Full range                                              | 75                                                                                 |                                                                              |                                            |                                       |                 |                 |                              |    |
| $V_O$                                      | Output swing                                            | $R_L = 600\ \Omega$ to $0.9\text{ V}$ ,<br>$V_{ID} = \pm 100\text{ mV}$            | High level                                                                   | 25°C                                       | 1.65                                  | 1.72            | V               |                              |    |
|                                            |                                                         |                                                                                    |                                                                              | Full range                                 | 1.63                                  |                 |                 |                              |    |
|                                            |                                                         |                                                                                    | Low level                                                                    | 25°C                                       |                                       | 0.077           |                 | 0.105                        |    |
|                                            |                                                         |                                                                                    |                                                                              | Full range                                 |                                       |                 |                 | 0.120                        |    |
|                                            |                                                         |                                                                                    | $R_L = 2\text{ k}\Omega$ to $0.9\text{ V}$ ,<br>$V_{ID} = \pm 100\text{ mV}$ | High level                                 | 25°C                                  | 1.75            |                 | 1.77                         |    |
|                                            |                                                         |                                                                                    |                                                                              |                                            | Full range                            | 1.74            |                 |                              |    |
| Low level                                  | 25°C                                                    |                                                                                    | 0.024                                                                        | 0.035                                      |                                       |                 |                 |                              |    |
|                                            | Full range                                              |                                                                                    |                                                                              | 0.040                                      |                                       |                 |                 |                              |    |
| $I_{OS}$                                   | Output short-circuit current                            | $V_O = 0\text{ V}$ ,<br>$V_{ID} = 100\text{ mV}$                                   | Sourcing                                                                     | 25°C                                       | 4                                     | 8               | mA              |                              |    |
|                                            |                                                         |                                                                                    |                                                                              | Full range                                 | 3.3                                   |                 |                 |                              |    |
|                                            |                                                         | $V_O = 1.8\text{ V}$ ,<br>$V_{ID} = -100\text{ mV}$                                | Sinking                                                                      | 25°C                                       | 7                                     | 9               |                 |                              |    |
|                                            |                                                         |                                                                                    |                                                                              | Full range                                 | 5                                     |                 |                 |                              |    |
| GBW                                        | Gain bandwidth product                                  |                                                                                    |                                                                              | 25°C                                       |                                       | 1.4             |                 | MHz                          |    |

### Electrical Characteristics (continued)

$V_{CC+} = 1.8\text{ V}$ ,  $V_{CC-} = 0\text{ V}$ ,  $V_{IC} = V_{CC+}/2$ ,  $V_O = V_{CC+}/2$ , and  $R_L > 1\text{ M}\Omega$  (unless otherwise noted)

|          | PARAMETER                                       | TEST CONDITIONS                                                                       | T <sub>A</sub> | MIN | TYP   | MAX | UNIT                   |
|----------|-------------------------------------------------|---------------------------------------------------------------------------------------|----------------|-----|-------|-----|------------------------|
| SR       | Slew rate <sup>(1)</sup>                        |                                                                                       | 25°C           |     | 0.35  |     | V/ $\mu$ S             |
| $\Phi_m$ | Phase margin                                    |                                                                                       | 25°C           |     | 67    |     | °                      |
|          | Gain margin                                     |                                                                                       | 25°C           |     | 7     |     | dB                     |
| $V_n$    | Equivalent input noise voltage                  | $f = 1\text{ kHz}$ , $V_{IC} = 0.5\text{ V}$                                          | 25°C           |     | 60    |     | nV/ $\sqrt{\text{Hz}}$ |
| $I_n$    | Equivalent input noise current                  | $f = 1\text{ kHz}$                                                                    | 25°C           |     | 0.06  |     | pA/ $\sqrt{\text{Hz}}$ |
| THD      | Total harmonic distortion                       | $f = 1\text{ kHz}$ , $A_V = 1$ , $R_L = 600\ \Omega$ ,<br>$V_{ID} = 1\text{ V}_{p-p}$ | 25°C           |     | 0.023 |     | %                      |
|          | Amplifier-to-amplifier isolation <sup>(2)</sup> |                                                                                       | 25°C           |     | 123   |     | dB                     |

(1) Number specified is the slower of the positive and negative slew rates.

(2) Input referred,  $V_{CC+} = 5\text{ V}$  and  $R_L = 100\text{ k}\Omega$  connected to 2.5 V. Each amplifier is excited, in turn, with a 1-kHz signal to produce  $V_O = 3\text{ V}_{p-p}$ .

**Electrical Characteristics**
 $V_{CC+} = 2.7\text{ V}$ ,  $V_{CC-} = 0\text{ V}$ ,  $V_{IC} = V_{CC+}/2$ ,  $V_O = V_{CC+}/2$ , and  $R_L > 1\text{ M}\Omega$  (unless otherwise noted)

| PARAMETER         |                                                         | TEST CONDITIONS                                  |                                                             | $T_A$                                                            | MIN             | TYP       | MAX             | UNIT                         |       |
|-------------------|---------------------------------------------------------|--------------------------------------------------|-------------------------------------------------------------|------------------------------------------------------------------|-----------------|-----------|-----------------|------------------------------|-------|
| $V_{IO}$          | Input offset voltage                                    | LMV931 (single)                                  |                                                             | 25°C                                                             |                 | 1         | 4               | mV                           |       |
|                   |                                                         |                                                  |                                                             | Full range                                                       |                 |           | 6               |                              |       |
|                   |                                                         | LMV932 (dual), LMV934 (quad)                     |                                                             | 25°C                                                             |                 | 1         | 5.5             |                              |       |
|                   |                                                         |                                                  |                                                             | Full range                                                       |                 |           | 7.5             |                              |       |
| $\alpha_{V_{IO}}$ | Average temperature coefficient of input offset voltage |                                                  |                                                             | 25°C                                                             |                 | 5.5       |                 | $\mu\text{V}/^\circ\text{C}$ |       |
| $I_{IB}$          | Input bias current                                      |                                                  |                                                             | 25°C                                                             |                 | 15        | 35              | nA                           |       |
|                   |                                                         |                                                  |                                                             | 25°C                                                             |                 |           | 65              |                              |       |
|                   |                                                         |                                                  |                                                             | Full range                                                       |                 |           | 75              |                              |       |
| $I_{IO}$          | Input offset current                                    |                                                  |                                                             | 25°C                                                             |                 | 8         | 25              | nA                           |       |
|                   |                                                         |                                                  |                                                             | Full range                                                       |                 |           | 40              |                              |       |
| $I_{CC}$          | Supply current (per channel)                            |                                                  |                                                             | 25°C                                                             |                 | 105       | 190             | $\mu\text{A}$                |       |
|                   |                                                         |                                                  |                                                             | Full range                                                       |                 |           | 210             |                              |       |
| CMRR              | Common-mode rejection ratio                             |                                                  |                                                             | 25°C                                                             | 60              | 81        |                 | dB                           |       |
|                   |                                                         |                                                  |                                                             | -40°C to 85°C                                                    | 55              |           |                 |                              |       |
|                   |                                                         |                                                  |                                                             | -40°C to 125°C                                                   | 55              |           |                 |                              |       |
| $k_{SVR}$         | Supply-voltage rejection ratio                          |                                                  |                                                             | 25°C                                                             | 75              | 100       |                 | dB                           |       |
|                   |                                                         |                                                  |                                                             | Full range                                                       | 70              |           |                 |                              |       |
| $V_{ICR}$         | Common-mode input voltage range                         |                                                  | CMRR $\geq 50\text{ dB}$                                    | 25°C                                                             | $V_{CC-} - 0.2$ | -0.2 to 3 | $V_{CC+} + 0.2$ | V                            |       |
|                   |                                                         |                                                  |                                                             | -40°C to 85°C                                                    | $V_{CC-}$       |           | $V_{CC+}$       |                              |       |
|                   |                                                         |                                                  |                                                             | -40°C to 125°C                                                   | $V_{CC-} + 0.2$ |           | $V_{CC+} - 0.2$ |                              |       |
| $A_V$             | Large-signal voltage gain                               | LMV931                                           | $V_O = 0.2\text{ V to } 2.5\text{ V}$                       | $R_L = 600\ \Omega$ to 1.35 V                                    | 25°C            | 87        | 104             | dB                           |       |
|                   |                                                         |                                                  |                                                             | Full range                                                       | 86              |           |                 |                              |       |
|                   |                                                         | $R_L = 2\text{ k}\Omega$ to 1.35 V               |                                                             | 25°C                                                             | 92              | 110       |                 |                              |       |
|                   |                                                         | Full range                                       |                                                             | 91                                                               |                 |           |                 |                              |       |
|                   |                                                         | LMV932, LMV934                                   |                                                             | $R_L = 600\ \Omega$ to 1.35 V                                    | 25°C            | 78        | 90              |                              |       |
|                   |                                                         |                                                  |                                                             | Full range                                                       | 75              |           |                 |                              |       |
| $V_O$             | Output swing                                            |                                                  | $R_L = 600\ \Omega$ to 1.35 V, $V_{ID} = \pm 100\text{ mV}$ | High level                                                       | 25°C            | 2.55      | 2.62            | V                            |       |
|                   |                                                         |                                                  |                                                             | Full range                                                       | 2.53            |           |                 |                              |       |
|                   |                                                         | Low level                                        |                                                             | 25°C                                                             |                 | 0.083     | 0.11            |                              |       |
|                   |                                                         | Full range                                       |                                                             |                                                                  |                 | 0.13      |                 |                              |       |
|                   |                                                         |                                                  |                                                             | $R_L = 2\text{ k}\Omega$ to 1.35 V, $V_{ID} = \pm 100\text{ mV}$ | High level      | 25°C      | 2.65            |                              | 2.675 |
|                   |                                                         |                                                  |                                                             |                                                                  | Full range      | 2.64      |                 |                              |       |
|                   |                                                         | Low level                                        | 25°C                                                        |                                                                  | 0.025           | 0.04      |                 |                              |       |
|                   |                                                         | Full range                                       |                                                             |                                                                  | 0.045           |           |                 |                              |       |
| $I_{OS}$          | Output short-circuit current                            | $V_O = 0\text{ V}$ , $V_{ID} = 100\text{ mV}$    | Sourcing                                                    | 25°C                                                             | 20              | 30        | mA              |                              |       |
|                   |                                                         |                                                  |                                                             | Full range                                                       | 15              |           |                 |                              |       |
|                   |                                                         | $V_O = 2.7\text{ V}$ , $V_{ID} = -100\text{ mV}$ | Sinking                                                     | 25°C                                                             | 18              | 25        |                 |                              |       |
|                   |                                                         |                                                  |                                                             | Full range                                                       | 12              |           |                 |                              |       |
| GBW               | Gain bandwidth product                                  |                                                  |                                                             | 25°C                                                             |                 | 1.4       |                 | MHz                          |       |

**Electrical Characteristics (continued)**

$V_{CC+} = 2.7\text{ V}$ ,  $V_{CC-} = 0\text{ V}$ ,  $V_{IC} = V_{CC+}/2$ ,  $V_O = V_{CC+}/2$ , and  $R_L > 1\text{ M}\Omega$  (unless otherwise noted)

| PARAMETER | TEST CONDITIONS                                 | $T_A$                                                                                 | MIN | TYP   | MAX | UNIT                   |
|-----------|-------------------------------------------------|---------------------------------------------------------------------------------------|-----|-------|-----|------------------------|
| SR        | Slew rate <sup>(1)</sup>                        | 25°C                                                                                  |     | 0.4   |     | V/ $\mu$ S             |
| $\Phi_m$  | Phase margin                                    | 25°C                                                                                  |     | 70    |     | °                      |
|           | Gain margin                                     | 25°C                                                                                  |     | 7.5   |     | dB                     |
| $V_n$     | Equivalent input noise voltage                  | $f = 1\text{ kHz}$ , $V_{IC} = 0.5\text{ V}$                                          |     | 57    |     | nV/ $\sqrt{\text{Hz}}$ |
| $I_n$     | Equivalent input noise current                  | $f = 1\text{ kHz}$                                                                    |     | 0.082 |     | pA/ $\sqrt{\text{Hz}}$ |
| THD       | Total harmonic distortion                       | $f = 1\text{ kHz}$ , $A_V = 1$ , $R_L = 600\ \Omega$ ,<br>$V_{ID} = 1\text{ V}_{p-p}$ |     | 0.022 |     | %                      |
|           | Amplifier-to-amplifier isolation <sup>(2)</sup> | 25°C                                                                                  |     | 123   |     | dB                     |

(1) Number specified is the slower of the positive and negative slew rates.

(2) Input referred,  $V_{CC+} = 5\text{ V}$  and  $R_L = 100\text{ k}\Omega$  connected to 2.5 V. Each amplifier is excited, in turn, with a 1-kHz signal to produce  $V_O = 3\text{ V}_{p-p}$ .



## Electrical Characteristics

 $V_{CC+} = 5\text{ V}$ ,  $V_{CC-} = 0\text{ V}$ ,  $V_{IC} = V_{CC+}/2$ ,  $V_O = V_{CC+}/2$ , and  $R_L > 1\text{ M}\Omega$  (unless otherwise noted)

| PARAMETER         |                                                         | TEST CONDITIONS                                |                                       | $T_A$                                                           | MIN                          | TYP         | MAX             | UNIT                         |      |
|-------------------|---------------------------------------------------------|------------------------------------------------|---------------------------------------|-----------------------------------------------------------------|------------------------------|-------------|-----------------|------------------------------|------|
| $V_{IO}$          | Input offset voltage                                    | LMV931 (single)                                |                                       | 25°C                                                            |                              | 1           | 4               | mV                           |      |
|                   |                                                         |                                                |                                       | Full range                                                      |                              |             | 6               |                              |      |
|                   |                                                         | LMV932 (dual), LMV934 (quad)                   |                                       | 25°C                                                            |                              | 1           | 5.5             |                              |      |
|                   |                                                         |                                                |                                       | Full range                                                      |                              |             | 7.5             |                              |      |
| $\alpha_{V_{IO}}$ | Average temperature coefficient of input offset voltage |                                                |                                       | 25°C                                                            |                              | 5.5         |                 | $\mu\text{V}/^\circ\text{C}$ |      |
| $I_{IB}$          | Input bias current                                      |                                                |                                       | 25°C                                                            |                              | 15          | 35              | nA                           |      |
|                   |                                                         |                                                |                                       | 25°C                                                            |                              |             | 65              |                              |      |
|                   |                                                         |                                                |                                       | Full range                                                      |                              |             | 75              |                              |      |
| $I_{IO}$          | Input offset current                                    |                                                |                                       | 25°C                                                            |                              | 9           | 25              | nA                           |      |
|                   |                                                         |                                                |                                       | Full range                                                      |                              |             | 40              |                              |      |
| $I_{CC}$          | Supply current (per channel)                            |                                                |                                       | 25°C                                                            |                              | 116         | 210             | $\mu\text{A}$                |      |
|                   |                                                         |                                                |                                       | Full range                                                      |                              |             | 230             |                              |      |
| CMRR              | Common-mode rejection ratio                             |                                                |                                       | 25°C                                                            | 60                           | 86          |                 | dB                           |      |
|                   |                                                         |                                                |                                       | –40°C to 85°C                                                   | 55                           |             |                 |                              |      |
|                   |                                                         |                                                |                                       | –40°C to 125°C                                                  | 55                           |             |                 |                              |      |
| $k_{SVR}$         | Supply-voltage rejection ratio                          |                                                |                                       | 25°C                                                            | 75                           | 100         |                 | dB                           |      |
|                   |                                                         |                                                |                                       | Full range                                                      | 70                           |             |                 |                              |      |
| $V_{ICR}$         | Common-mode input voltage range                         | CMRR $\geq 50\text{ dB}$                       |                                       | 25°C                                                            | $V_{CC-} - 0.2$              | –0.2 to 5.3 | $V_{CC+} + 0.2$ | V                            |      |
|                   |                                                         |                                                |                                       | –40°C to 85°C                                                   | $V_{CC-}$                    |             | $V_{CC+}$       |                              |      |
|                   |                                                         |                                                |                                       | –40°C to 125°C                                                  | $V_{CC-} + 0.3$              |             | $V_{CC+} - 0.3$ |                              |      |
| $A_V$             | Large-signal voltage gain                               | LMV931                                         | $V_O = 0.2\text{ V to } 4.8\text{ V}$ | $R_L = 600\ \Omega$ to 2.5 V                                    | 25°C                         | 88          | 102             | dB                           |      |
|                   |                                                         |                                                |                                       |                                                                 | Full range                   | 87          |                 |                              |      |
|                   |                                                         |                                                |                                       | $R_L = 2\text{ k}\Omega$ to 2.5 V                               | 25°C                         | 94          | 113             |                              |      |
|                   |                                                         |                                                |                                       |                                                                 | Full range                   | 93          |                 |                              |      |
|                   |                                                         |                                                |                                       | LMV932, LMV934                                                  | $R_L = 600\ \Omega$ to 2.5 V | 25°C        | 81              |                              | 90   |
|                   |                                                         |                                                |                                       |                                                                 |                              | Full range  | 78              |                              |      |
|                   | $R_L = 2\text{ k}\Omega$ to 2.5 V                       | 25°C                                           | 85                                    | 100                                                             |                              |             |                 |                              |      |
|                   |                                                         | Full range                                     | 82                                    |                                                                 |                              |             |                 |                              |      |
| $V_O$             | Output swing                                            |                                                |                                       | $R_L = 600\ \Omega$ to 2.5 V, $V_{ID} = \pm 100\text{ mV}$      | 25°C                         | 4.855       | 4.89            | V                            |      |
|                   |                                                         |                                                |                                       |                                                                 | Full range                   | 4.835       |                 |                              |      |
|                   |                                                         |                                                |                                       | Low level                                                       | 25°C                         |             | 0.12            |                              | 0.16 |
|                   |                                                         |                                                |                                       |                                                                 | Full range                   |             |                 |                              | 0.18 |
|                   |                                                         |                                                |                                       | $R_L = 2\text{ k}\Omega$ to 2.5 V, $V_{ID} = \pm 100\text{ mV}$ | 25°C                         | 4.945       | 4.967           |                              |      |
|                   |                                                         |                                                |                                       |                                                                 | Full range                   | 4.935       |                 |                              |      |
| Low level         | 25°C                                                    |                                                | 0.037                                 | 0.065                                                           |                              |             |                 |                              |      |
|                   | Full range                                              |                                                |                                       | 0.075                                                           |                              |             |                 |                              |      |
| $I_{OS}$          | Output short-circuit current                            | $V_O = 0\text{ V}$ , $V_{ID} = 100\text{ mV}$  | Sourcing                              | 25°C                                                            | 80                           | 100         | mA              |                              |      |
|                   |                                                         |                                                |                                       | Full range                                                      | 68                           |             |                 |                              |      |
|                   |                                                         | $V_O = 5\text{ V}$ , $V_{ID} = -100\text{ mV}$ | Sinking                               | 25°C                                                            | 58                           | 65          |                 |                              |      |
|                   |                                                         |                                                |                                       | Full range                                                      | 45                           |             |                 |                              |      |
| GBW               | Gain bandwidth product                                  |                                                |                                       | 25°C                                                            |                              | 1.5         |                 | MHz                          |      |

**Electrical Characteristics (continued)**

$V_{CC+} = 5\text{ V}$ ,  $V_{CC-} = 0\text{ V}$ ,  $V_{IC} = V_{CC+}/2$ ,  $V_O = V_{CC+}/2$ , and  $R_L > 1\text{ M}\Omega$  (unless otherwise noted)

|          | PARAMETER                                       | TEST CONDITIONS                                                                       | $T_A$ | MIN | TYP   | MAX | UNIT                   |
|----------|-------------------------------------------------|---------------------------------------------------------------------------------------|-------|-----|-------|-----|------------------------|
| SR       | Slew rate <sup>(1)</sup>                        |                                                                                       | 25°C  |     | 0.42  |     | V/ $\mu$ S             |
| $\Phi_m$ | Phase margin                                    |                                                                                       | 25°C  |     | 71    |     | °                      |
|          | Gain margin                                     |                                                                                       | 25°C  |     | 8     |     | dB                     |
| $V_n$    | Equivalent input noise voltage                  | $f = 1\text{ kHz}$ , $V_{IC} = 0.5\text{ V}$                                          | 25°C  |     | 50    |     | nV/ $\sqrt{\text{Hz}}$ |
| $I_n$    | Equivalent input noise current                  | $f = 1\text{ kHz}$                                                                    | 25°C  |     | 0.07  |     | pA/ $\sqrt{\text{Hz}}$ |
| THD      | Total harmonic distortion                       | $f = 1\text{ kHz}$ , $A_V = 1$ , $R_L = 600\ \Omega$ ,<br>$V_{ID} = 1\text{ V}_{p-p}$ | 25°C  |     | 0.022 |     | %                      |
|          | Amplifier-to-amplifier isolation <sup>(2)</sup> |                                                                                       | 25°C  |     | 123   |     | dB                     |

- (1) Number specified is the slower of the positive and negative slew rates.
- (2) Input referred,  $V_{CC+} = 5\text{ V}$  and  $R_L = 100\text{ k}\Omega$  connected to 2.5 V. Each amplifier is excited, in turn, with a 1-kHz signal to produce  $V_O = 3\text{ V}_{p-p}$ .

**TYPICAL CHARACTERISTICS**

$V_{CC+} = 5\text{ V}$ , Single Supply,  $T_A = 25^\circ\text{C}$  (unless otherwise specified)

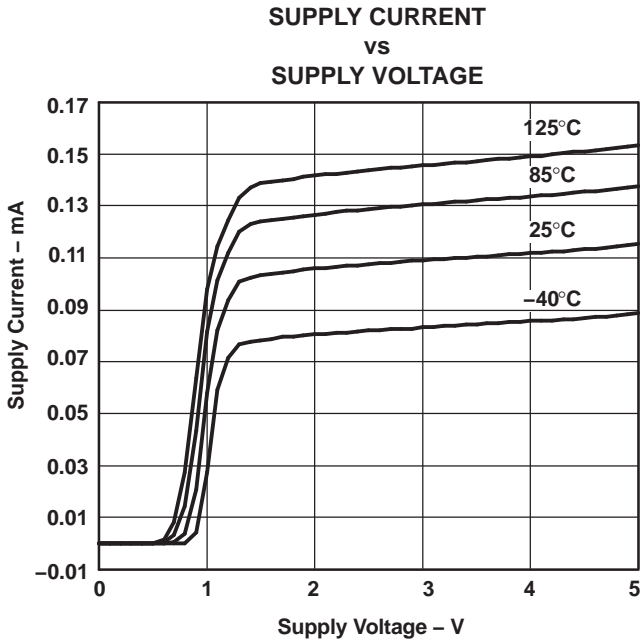

Figure 2.

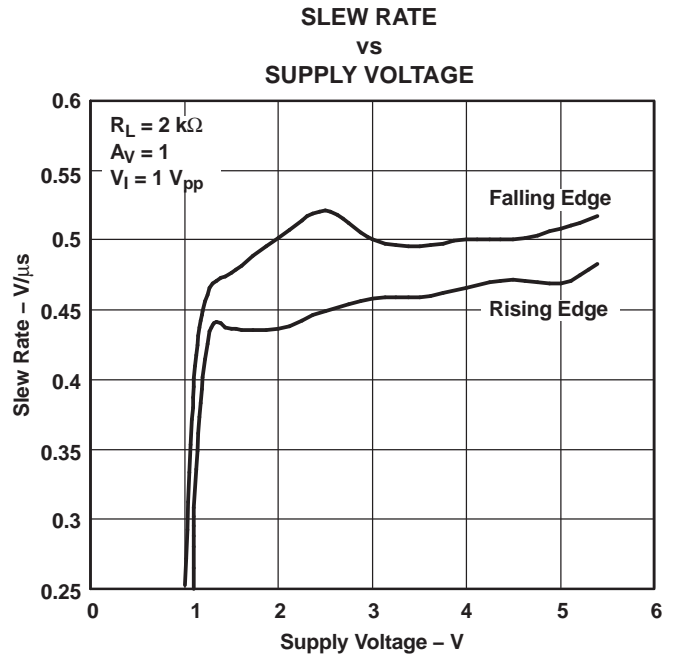

Figure 3.

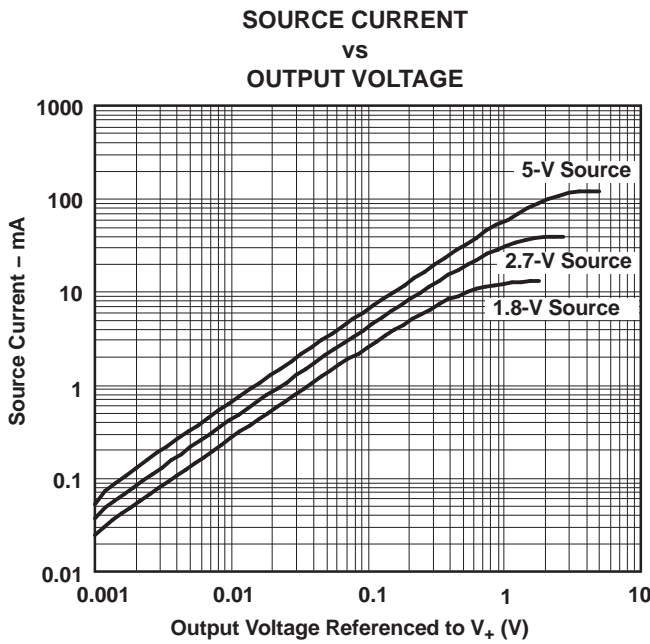

Figure 4.

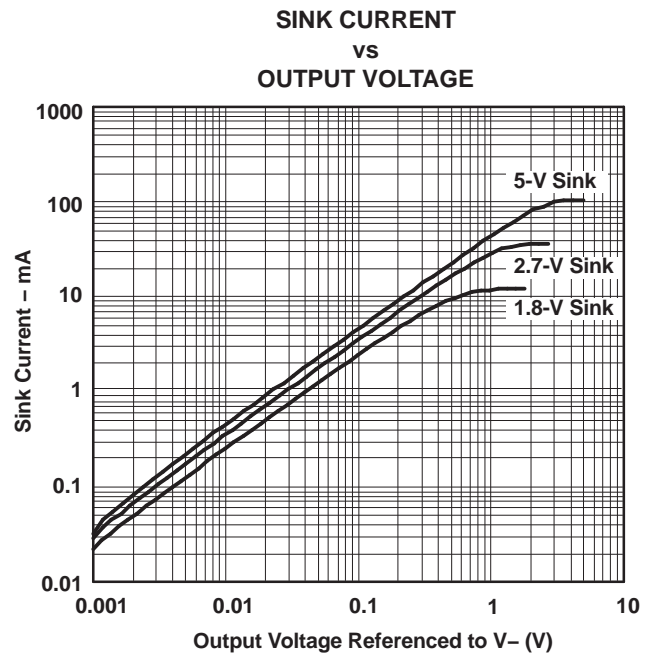

Figure 5.

**TYPICAL CHARACTERISTICS (continued)**

$V_{CC+} = 5\text{ V}$ , Single Supply,  $T_A = 25^\circ\text{C}$  (unless otherwise specified)

**OUTPUT VOLTAGE SWING  
 VS  
 SUPPLY VOLTAGE**

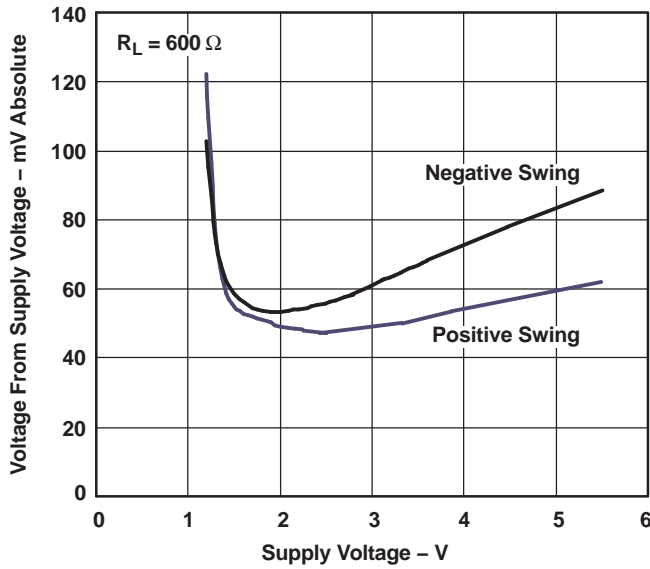

Figure 6.

**OUTPUT VOLTAGE SWING  
 VS  
 SUPPLY VOLTAGE**

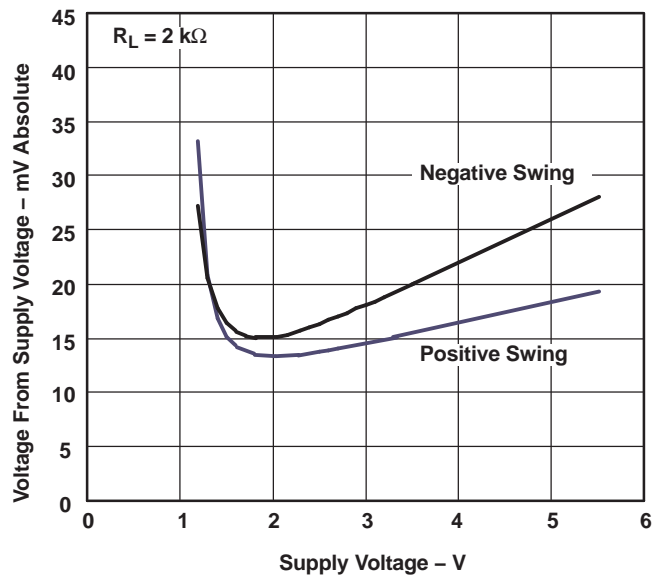

Figure 7.

**SHORT-CIRCUIT CURRENT (SINK)  
 VS  
 TEMPERATURE**

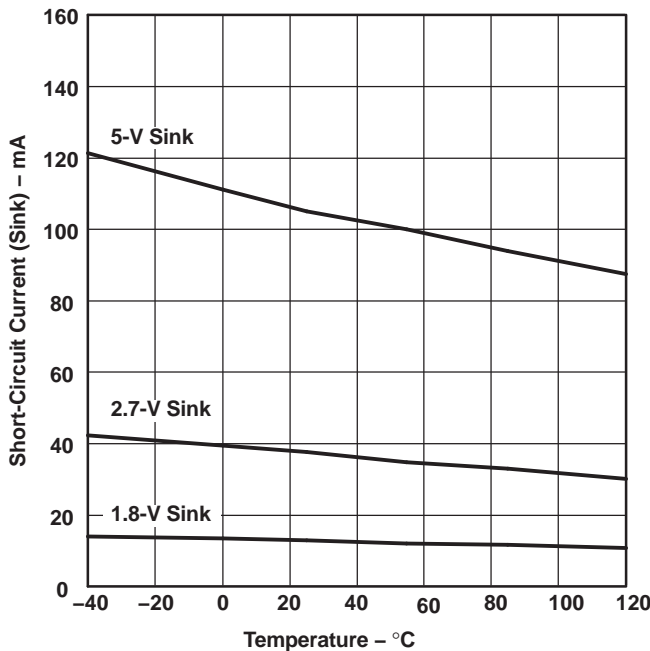

Figure 8.

**SHORT-CIRCUIT CURRENT (SOURCE)  
 VS  
 TEMPERATURE**

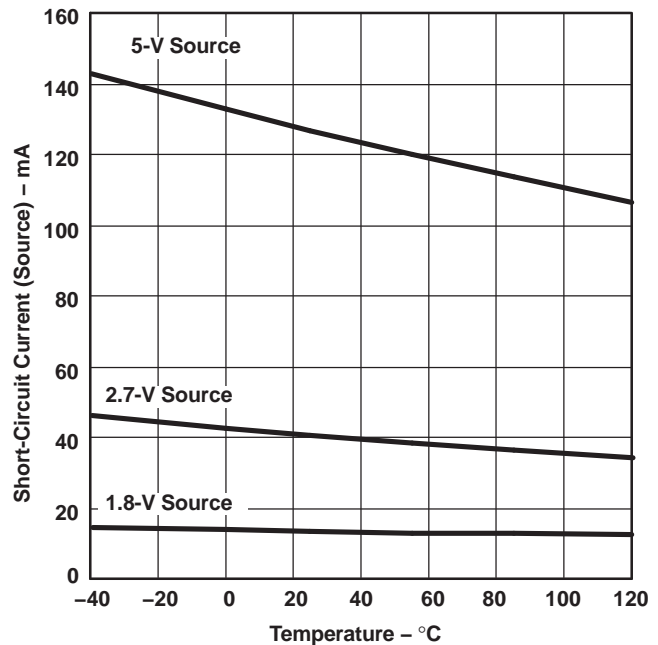

Figure 9.

TYPICAL CHARACTERISTICS (continued)

V<sub>CC+</sub> = 5 V, Single Supply, T<sub>A</sub> = 25°C (unless otherwise specified)

1.8-V FREQUENCY RESPONSE

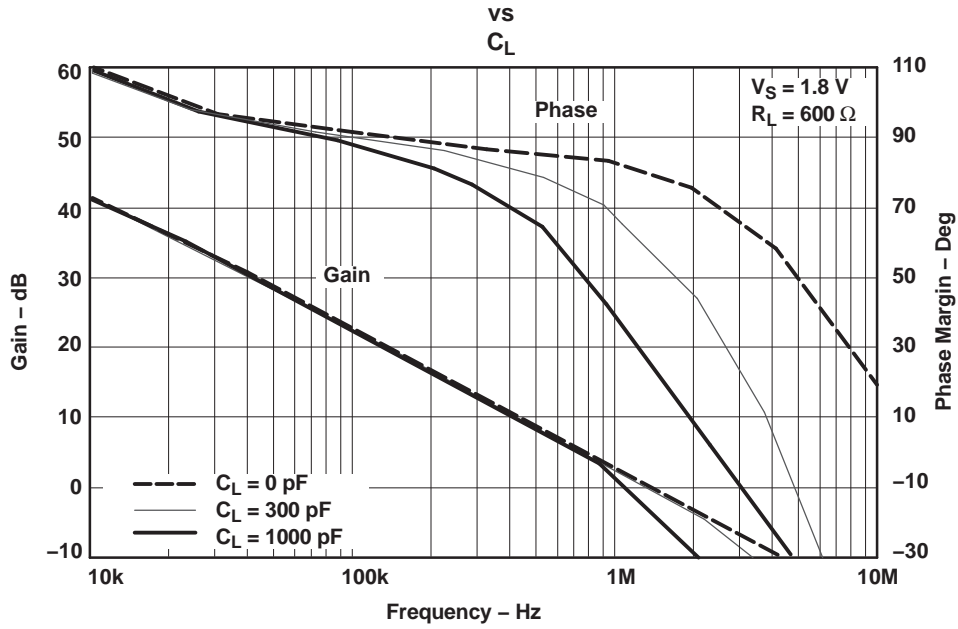

Figure 10.

5-V FREQUENCY RESPONSE

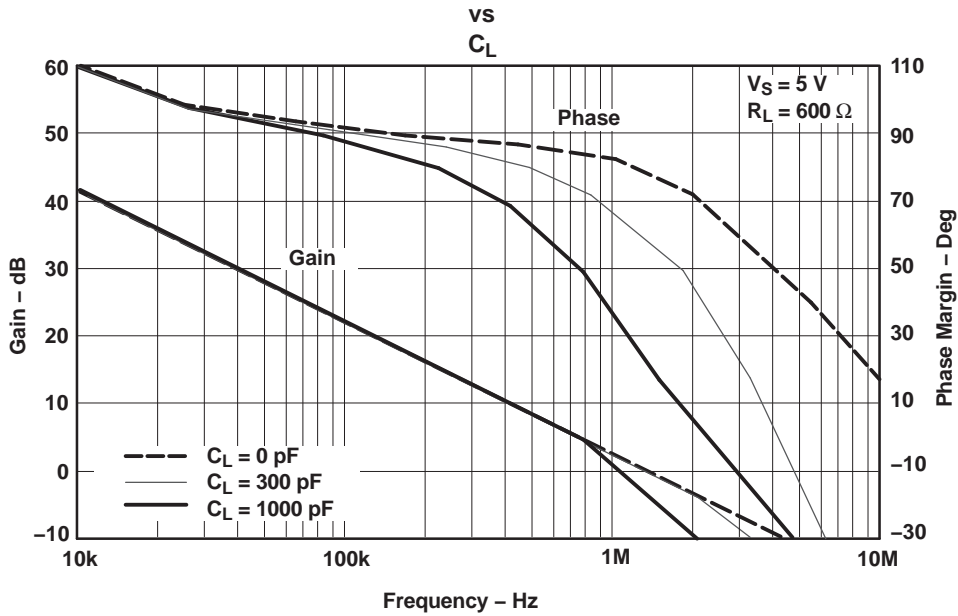

Figure 11.

**TYPICAL CHARACTERISTICS (continued)**

$V_{CC+} = 5\text{ V}$ , Single Supply,  $T_A = 25^\circ\text{C}$  (unless otherwise specified)

**1.8-V FREQUENCY RESPONSE**

vs  
TEMPERATURE

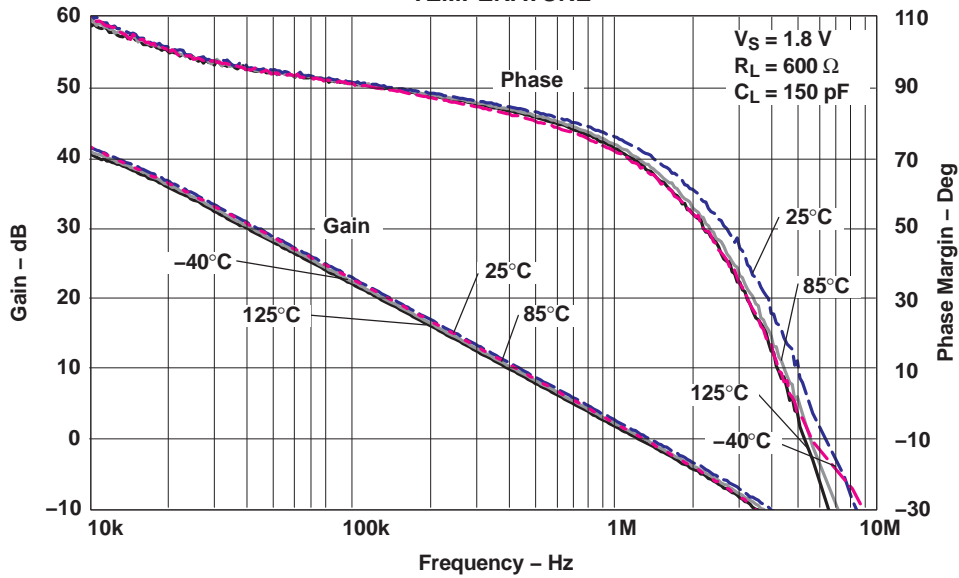

Figure 12.

**5-V FREQUENCY RESPONSE**

vs  
TEMPERATURE

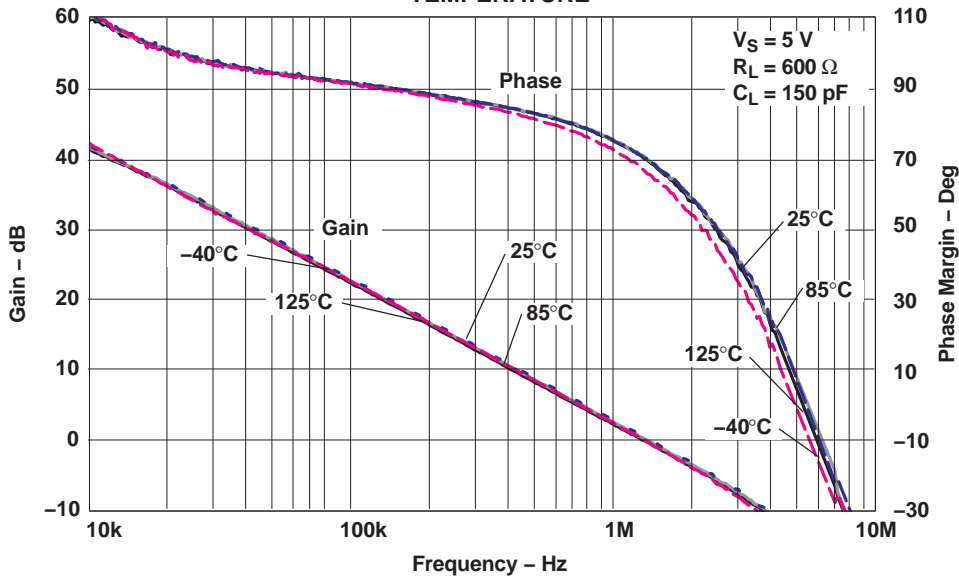

Figure 13.

TYPICAL CHARACTERISTICS (continued)

V<sub>CC+</sub> = 5 V, Single Supply, T<sub>A</sub> = 25°C (unless otherwise specified)

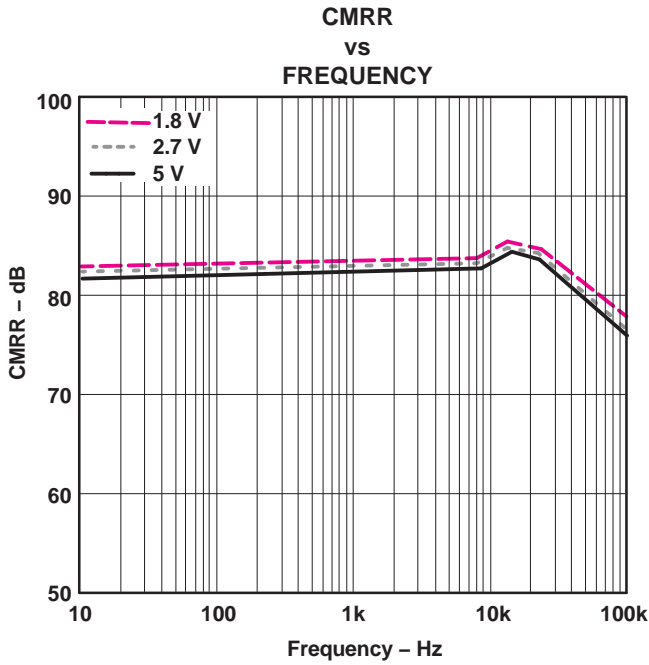

Figure 14.

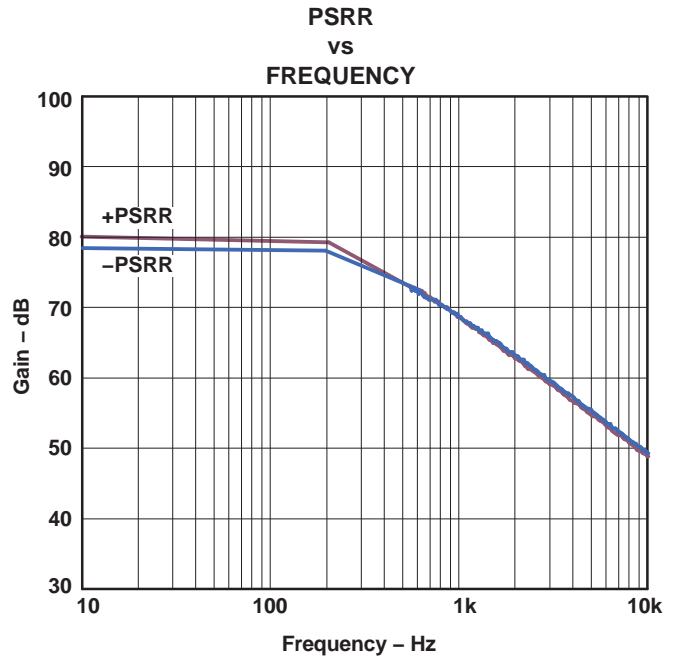

Figure 15.

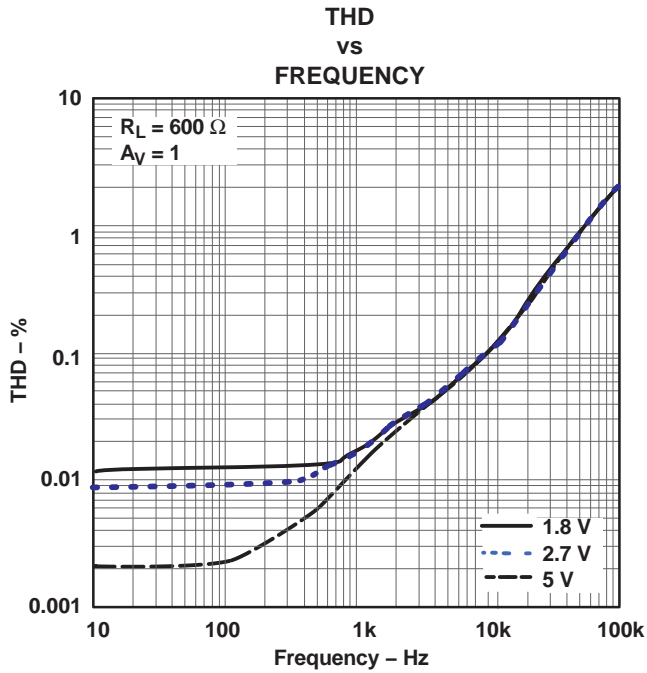

Figure 16.

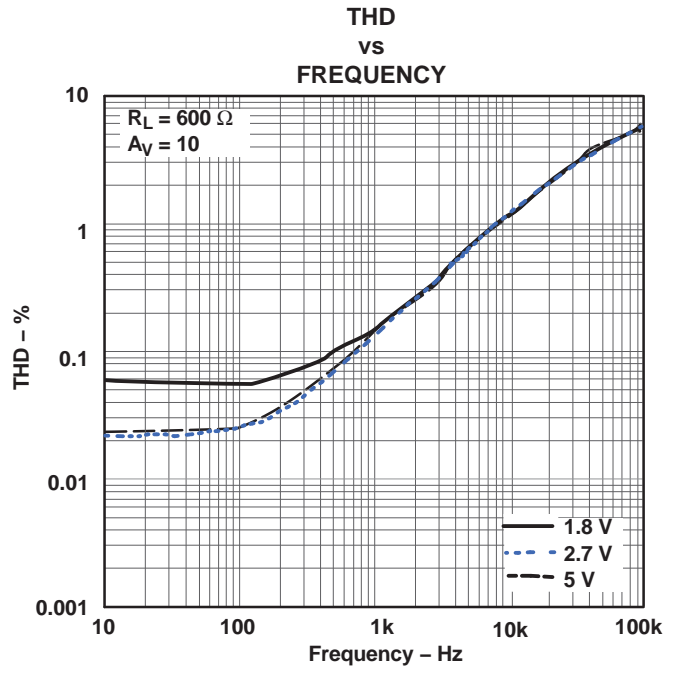

Figure 17.

**TYPICAL CHARACTERISTICS (continued)**

$V_{CC+} = 5\text{ V}$ , Single Supply,  $T_A = 25^\circ\text{C}$  (unless otherwise specified)

**SMALL-SIGNAL NONINVERTING RESPONSE**

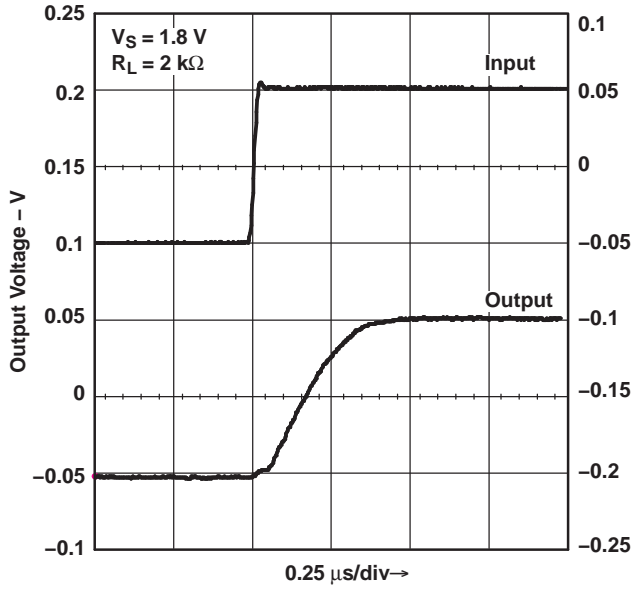

Figure 18.

**SMALL-SIGNAL NONINVERTING RESPONSE**

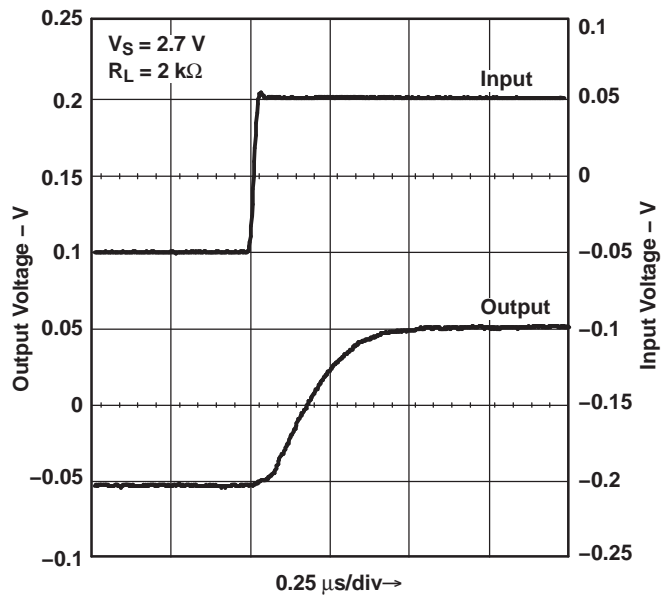

Figure 19.

**SMALL-SIGNAL NONINVERTING RESPONSE**

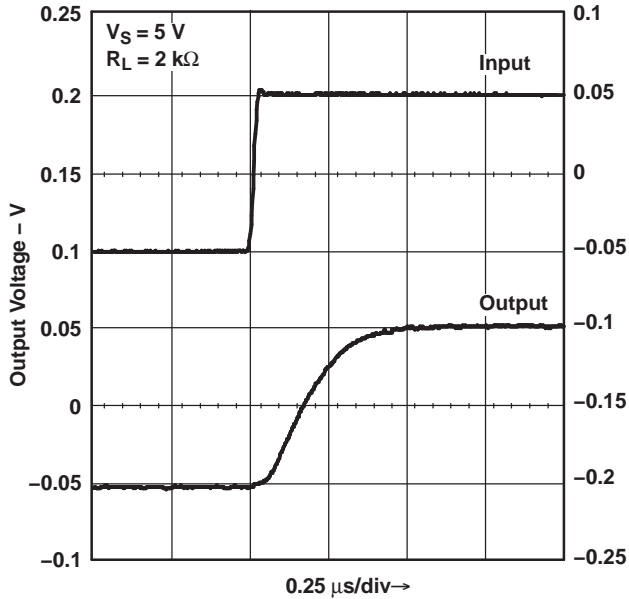

Figure 20.

**LARGE-SIGNAL NONINVERTING RESPONSE**

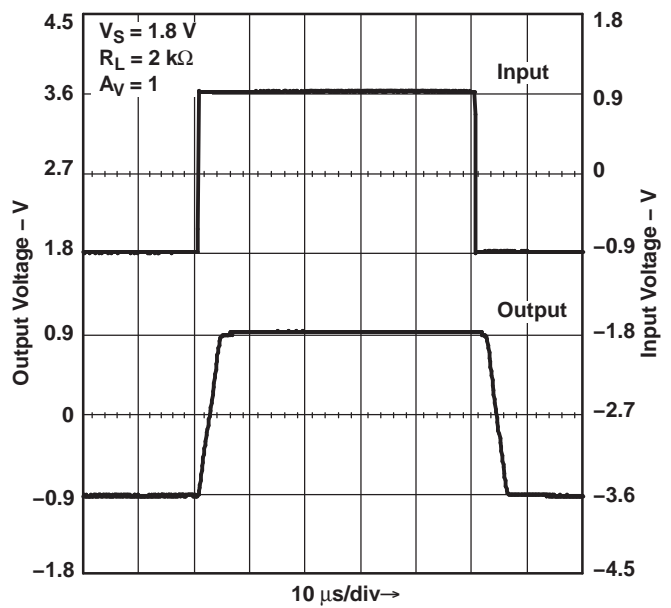

Figure 21.



TYPICAL CHARACTERISTICS (continued)

$V_{CC+} = 5\text{ V}$ , Single Supply,  $T_A = 25^\circ\text{C}$  (unless otherwise specified)

LARGE-SIGNAL NONINVERTING RESPONSE

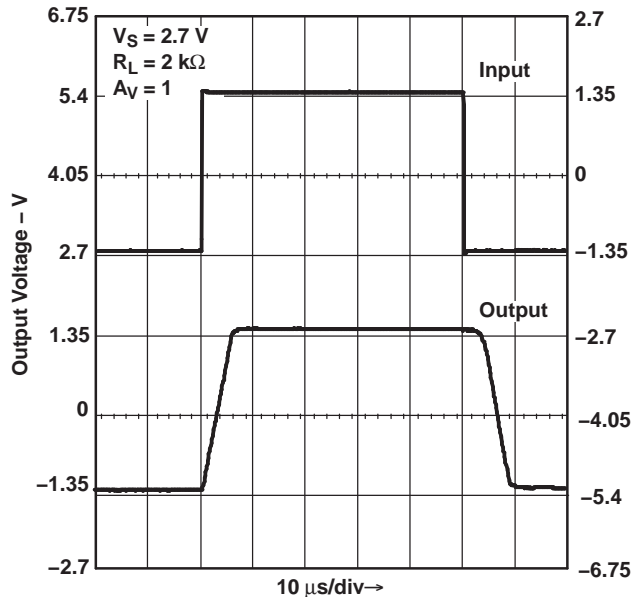

Figure 22.

LARGE-SIGNAL NONINVERTING RESPONSE

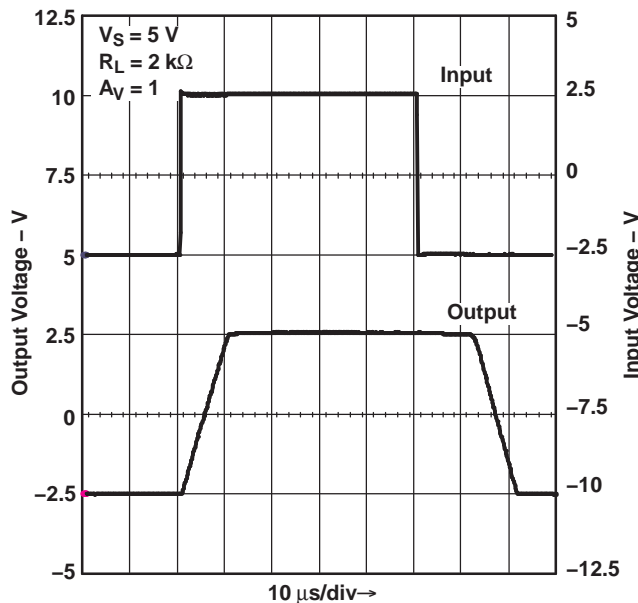

Figure 23.

OFFSET VOLTAGE vs COMMON-MODE RANGE

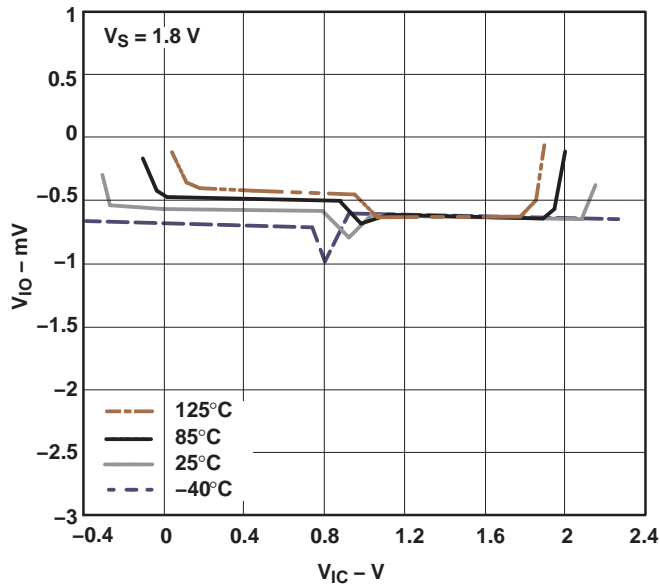

Figure 24.

OFFSET VOLTAGE vs COMMON-MODE RANGE

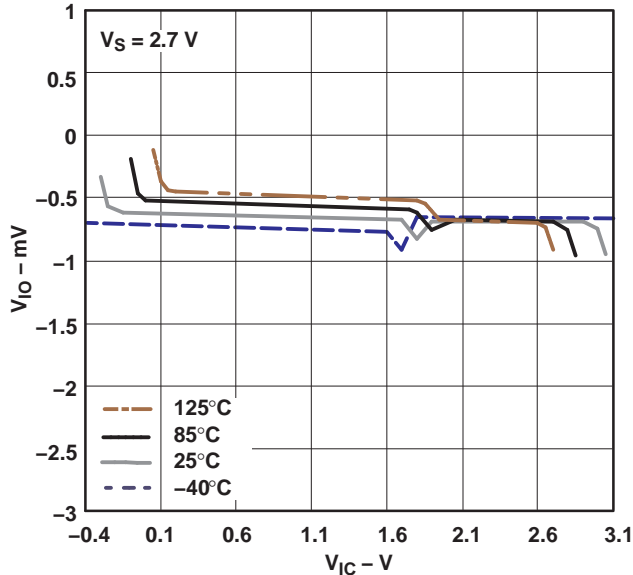
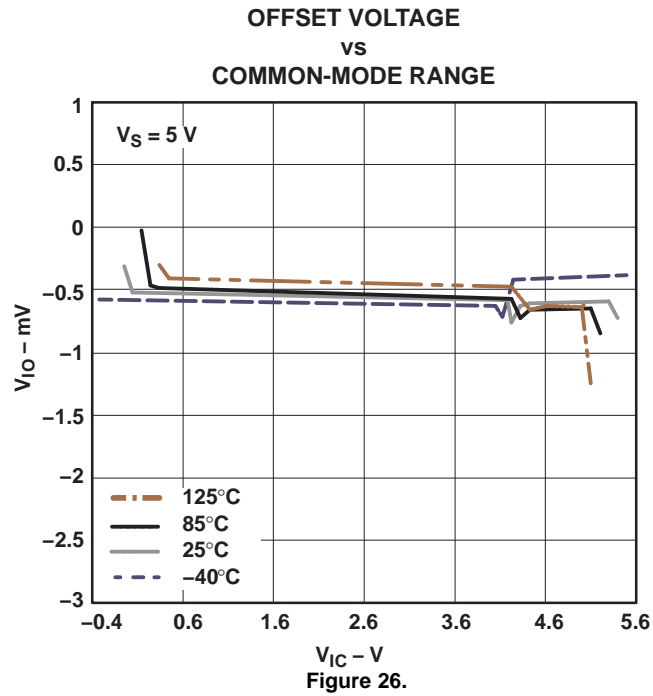

Figure 25.

### TYPICAL CHARACTERISTICS (continued)

$V_{CC+} = 5\text{ V}$ , Single Supply,  $T_A = 25^\circ\text{C}$  (unless otherwise specified)



**PACKAGING INFORMATION**

| Orderable Device | Status<br>(1) | Package Type | Package<br>Drawing | Pins | Package<br>Qty | Eco Plan<br>(2) | Lead/Ball Finish | MSL Peak Temp<br>(3) | Op Temp (°C) | Device Marking<br>(4/5) | Samples |
|------------------|---------------|--------------|--------------------|------|----------------|-----------------|------------------|----------------------|--------------|-------------------------|---------|
| LMV931IDBVR      | OBSOLETE      | SOT-23       | DBV                | 5    |                | TBD             | Call TI          | Call TI              | -40 to 125   | (RBBB ~ RBBC ~ RBBI)    |         |
| LMV931IDBVRE4    | OBSOLETE      | SOT-23       | DBV                | 5    |                | TBD             | Call TI          | Call TI              | -40 to 125   |                         |         |
| LMV931IDBVRG4    | OBSOLETE      | SOT-23       | DBV                | 5    |                | TBD             | Call TI          | Call TI              | -40 to 125   |                         |         |
| LMV931IDCKR      | OBSOLETE      | SC70         | DCK                | 5    |                | TBD             | Call TI          | Call TI              | -40 to 125   | (RBB ~ RBC ~ RBI)       |         |
| LMV931IDCKRE4    | OBSOLETE      | SC70         | DCK                | 5    |                | TBD             | Call TI          | Call TI              | -40 to 125   |                         |         |
| LMV931IDCKRG4    | OBSOLETE      | SC70         | DCK                | 5    |                | TBD             | Call TI          | Call TI              | -40 to 125   |                         |         |
| LMV932ID         | OBSOLETE      | SOIC         | D                  | 8    |                | TBD             | Call TI          | Call TI              | -40 to 125   | MV932I                  |         |
| LMV932IDE4       | OBSOLETE      | SOIC         | D                  | 8    |                | TBD             | Call TI          | Call TI              | -40 to 125   |                         |         |
| LMV932IDG4       | OBSOLETE      | SOIC         | D                  | 8    |                | TBD             | Call TI          | Call TI              | -40 to 125   |                         |         |
| LMV932IDGKR      | OBSOLETE      | VSSOP        | DGK                | 8    |                | TBD             | Call TI          | Call TI              | -40 to 125   | (RD6 ~ RDB)             |         |
| LMV932IDGKRG4    | OBSOLETE      | VSSOP        | DGK                | 8    |                | TBD             | Call TI          | Call TI              | -40 to 125   |                         |         |
| LMV932IDR        | OBSOLETE      | SOIC         | D                  | 8    |                | TBD             | Call TI          | Call TI              | -40 to 125   | MV932I                  |         |
| LMV932IDRE4      | OBSOLETE      | SOIC         | D                  | 8    |                | TBD             | Call TI          | Call TI              | -40 to 125   |                         |         |
| LMV932IDRG4      | OBSOLETE      | SOIC         | D                  | 8    |                | TBD             | Call TI          | Call TI              | -40 to 125   |                         |         |
| LMV934ID         | OBSOLETE      | SOIC         | D                  | 14   |                | TBD             | Call TI          | Call TI              | -40 to 125   | LMV934I                 |         |
| LMV934IDE4       | OBSOLETE      | SOIC         | D                  | 14   |                | TBD             | Call TI          | Call TI              | -40 to 125   |                         |         |
| LMV934IDG4       | OBSOLETE      | SOIC         | D                  | 14   |                | TBD             | Call TI          | Call TI              | -40 to 125   |                         |         |
| LMV934IDR        | OBSOLETE      | SOIC         | D                  | 14   |                | TBD             | Call TI          | Call TI              | -40 to 125   | LMV934I                 |         |
| LMV934IDRE4      | OBSOLETE      | SOIC         | D                  | 14   |                | TBD             | Call TI          | Call TI              | -40 to 125   |                         |         |
| LMV934IDRG4      | OBSOLETE      | SOIC         | D                  | 14   |                | TBD             | Call TI          | Call TI              | -40 to 125   |                         |         |
| LMV934IPW        | OBSOLETE      | TSSOP        | PW                 | 14   |                | TBD             | Call TI          | Call TI              | -40 to 125   | MV934I                  |         |
| LMV934IPWE4      | OBSOLETE      | TSSOP        | PW                 | 14   |                | TBD             | Call TI          | Call TI              | -40 to 125   |                         |         |
| LMV934IPWG4      | OBSOLETE      | TSSOP        | PW                 | 14   |                | TBD             | Call TI          | Call TI              | -40 to 125   |                         |         |
| LMV934IPWR       | OBSOLETE      | TSSOP        | PW                 | 14   |                | TBD             | Call TI          | Call TI              | -40 to 125   | MV934I                  |         |
| LMV934IPWRE4     | OBSOLETE      | TSSOP        | PW                 | 14   |                | TBD             | Call TI          | Call TI              | -40 to 125   |                         |         |
| LMV934IPWRG4     | OBSOLETE      | TSSOP        | PW                 | 14   |                | TBD             | Call TI          | Call TI              | -40 to 125   |                         |         |

(1) The marketing status values are defined as follows:

**ACTIVE:** Product device recommended for new designs.

**LIFEBUY:** TI has announced that the device will be discontinued, and a lifetime-buy period is in effect.

---

**NRND:** Not recommended for new designs. Device is in production to support existing customers, but TI does not recommend using this part in a new design.

**PREVIEW:** Device has been announced but is not in production. Samples may or may not be available.

**OBSOLETE:** TI has discontinued the production of the device.

<sup>(2)</sup> Eco Plan - The planned eco-friendly classification: Pb-Free (RoHS), Pb-Free (RoHS Exempt), or Green (RoHS & no Sb/Br) - please check <http://www.ti.com/productcontent> for the latest availability information and additional product content details.

**TBD:** The Pb-Free/Green conversion plan has not been defined.

**Pb-Free (RoHS):** TI's terms "Lead-Free" or "Pb-Free" mean semiconductor products that are compatible with the current RoHS requirements for all 6 substances, including the requirement that lead not exceed 0.1% by weight in homogeneous materials. Where designed to be soldered at high temperatures, TI Pb-Free products are suitable for use in specified lead-free processes.

**Pb-Free (RoHS Exempt):** This component has a RoHS exemption for either 1) lead-based flip-chip solder bumps used between the die and package, or 2) lead-based die adhesive used between the die and leadframe. The component is otherwise considered Pb-Free (RoHS compatible) as defined above.

**Green (RoHS & no Sb/Br):** TI defines "Green" to mean Pb-Free (RoHS compatible), and free of Bromine (Br) and Antimony (Sb) based flame retardants (Br or Sb do not exceed 0.1% by weight in homogeneous material)

<sup>(3)</sup> MSL, Peak Temp. -- The Moisture Sensitivity Level rating according to the JEDEC industry standard classifications, and peak solder temperature.

<sup>(4)</sup> There may be additional marking, which relates to the logo, the lot trace code information, or the environmental category on the device.

<sup>(5)</sup> Multiple Device Markings will be inside parentheses. Only one Device Marking contained in parentheses and separated by a "~" will appear on a device. If a line is indented then it is a continuation of the previous line and the two combined represent the entire Device Marking for that device.

**Important Information and Disclaimer:** The information provided on this page represents TI's knowledge and belief as of the date that it is provided. TI bases its knowledge and belief on information provided by third parties, and makes no representation or warranty as to the accuracy of such information. Efforts are underway to better integrate information from third parties. TI has taken and continues to take reasonable steps to provide representative and accurate information but may not have conducted destructive testing or chemical analysis on incoming materials and chemicals. TI and TI suppliers consider certain information to be proprietary, and thus CAS numbers and other limited information may not be available for release.

In no event shall TI's liability arising out of such information exceed the total purchase price of the TI part(s) at issue in this document sold by TI to Customer on an annual basis.

DBV (R-PDSO-G5)

PLASTIC SMALL-OUTLINE PACKAGE



- NOTES:
- A. All linear dimensions are in millimeters.
  - B. This drawing is subject to change without notice.
  - C. Body dimensions do not include mold flash or protrusion. Mold flash and protrusion shall not exceed 0.15 per side.
  - D. Falls within JEDEC MO-178 Variation AA.

DCK (R-PDSO-G5)

PLASTIC SMALL-OUTLINE PACKAGE

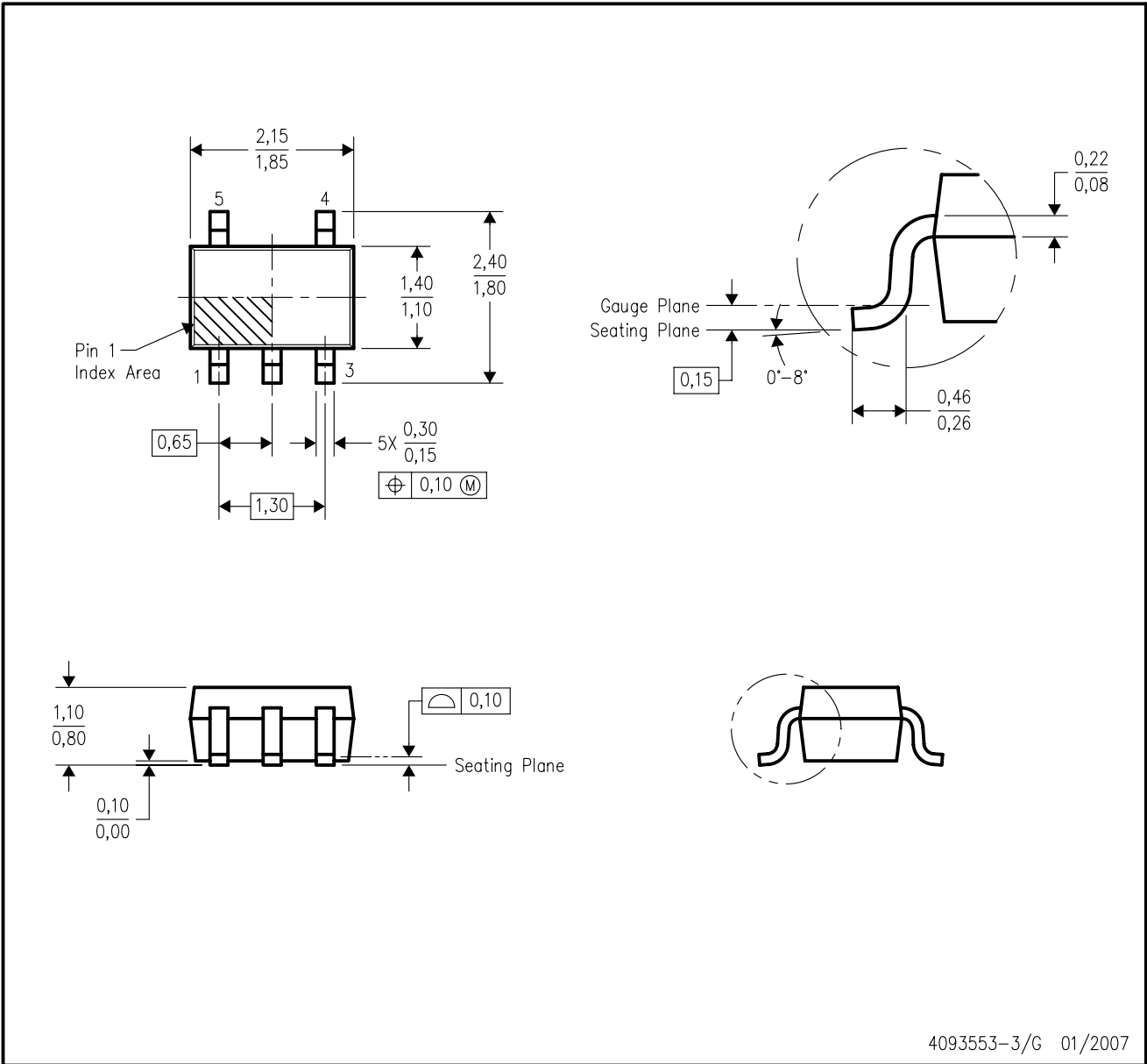

- NOTES:
- A. All linear dimensions are in millimeters.
  - B. This drawing is subject to change without notice.
  - C. Body dimensions do not include mold flash or protrusion. Mold flash and protrusion shall not exceed 0.15 per side.
  - D. Falls within JEDEC MO-203 variation AA.

DGK (S-PDSO-G8)

PLASTIC SMALL-OUTLINE PACKAGE



- NOTES:
- A. All linear dimensions are in millimeters.
  - B. This drawing is subject to change without notice.
  - C. Body length does not include mold flash, protrusions, or gate burrs. Mold flash, protrusions, or gate burrs shall not exceed 0.15 per end.
  - D. Body width does not include interlead flash. Interlead flash shall not exceed 0.50 per side.
  - E. Falls within JEDEC MO-187 variation AA, except interlead flash.

D (R-PDSO-G14)

PLASTIC SMALL OUTLINE

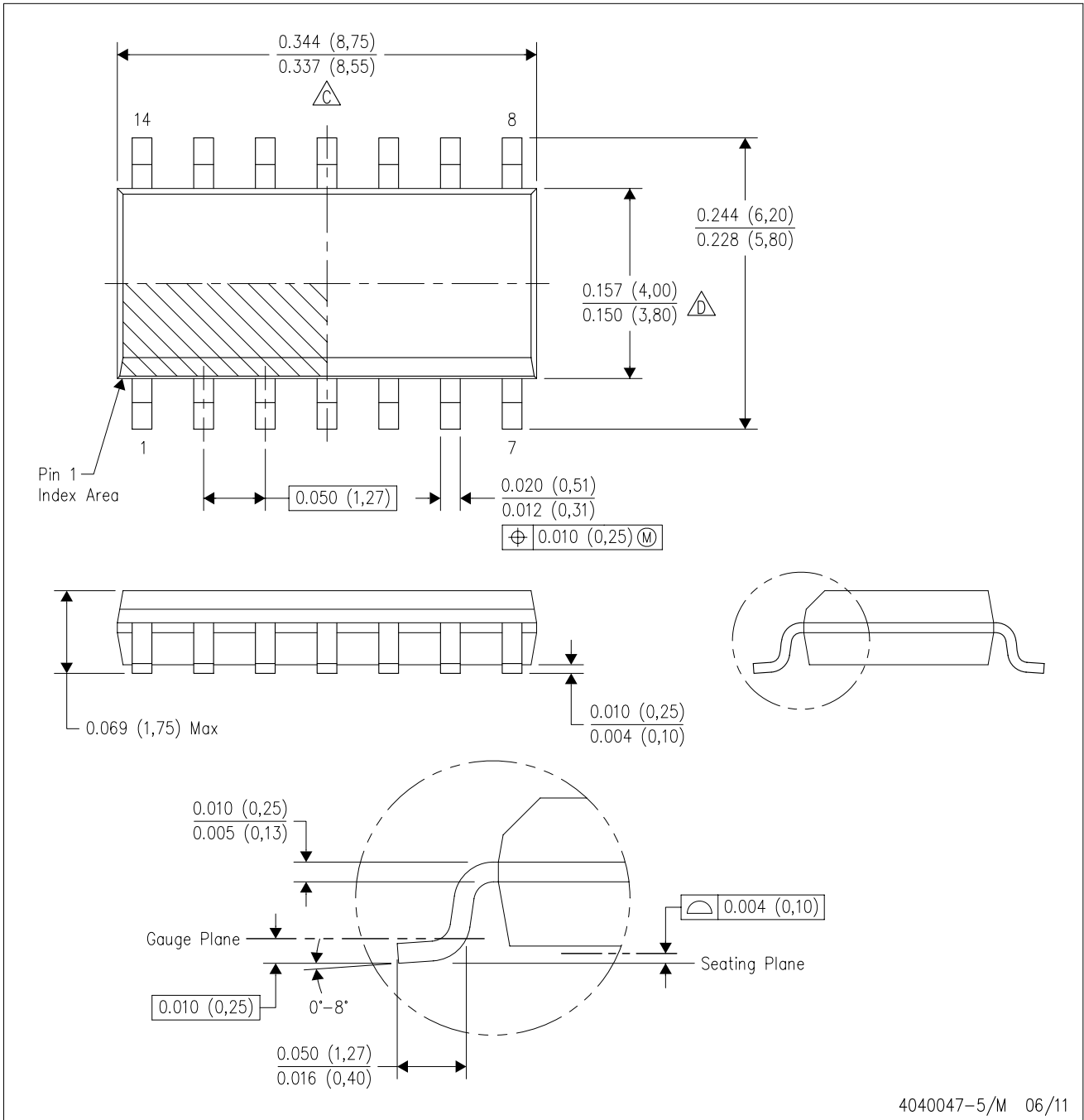

4040047-5/M 06/11

- NOTES: A. All linear dimensions are in inches (millimeters).  
 B. This drawing is subject to change without notice.  
 C. Body length does not include mold flash, protrusions, or gate burrs. Mold flash, protrusions, or gate burrs shall not exceed 0.006 (0,15) each side.  
 D. Body width does not include interlead flash. Interlead flash shall not exceed 0.017 (0,43) each side.  
 E. Reference JEDEC MS-012 variation AB.



PW (R-PDSO-G14)

PLASTIC SMALL OUTLINE

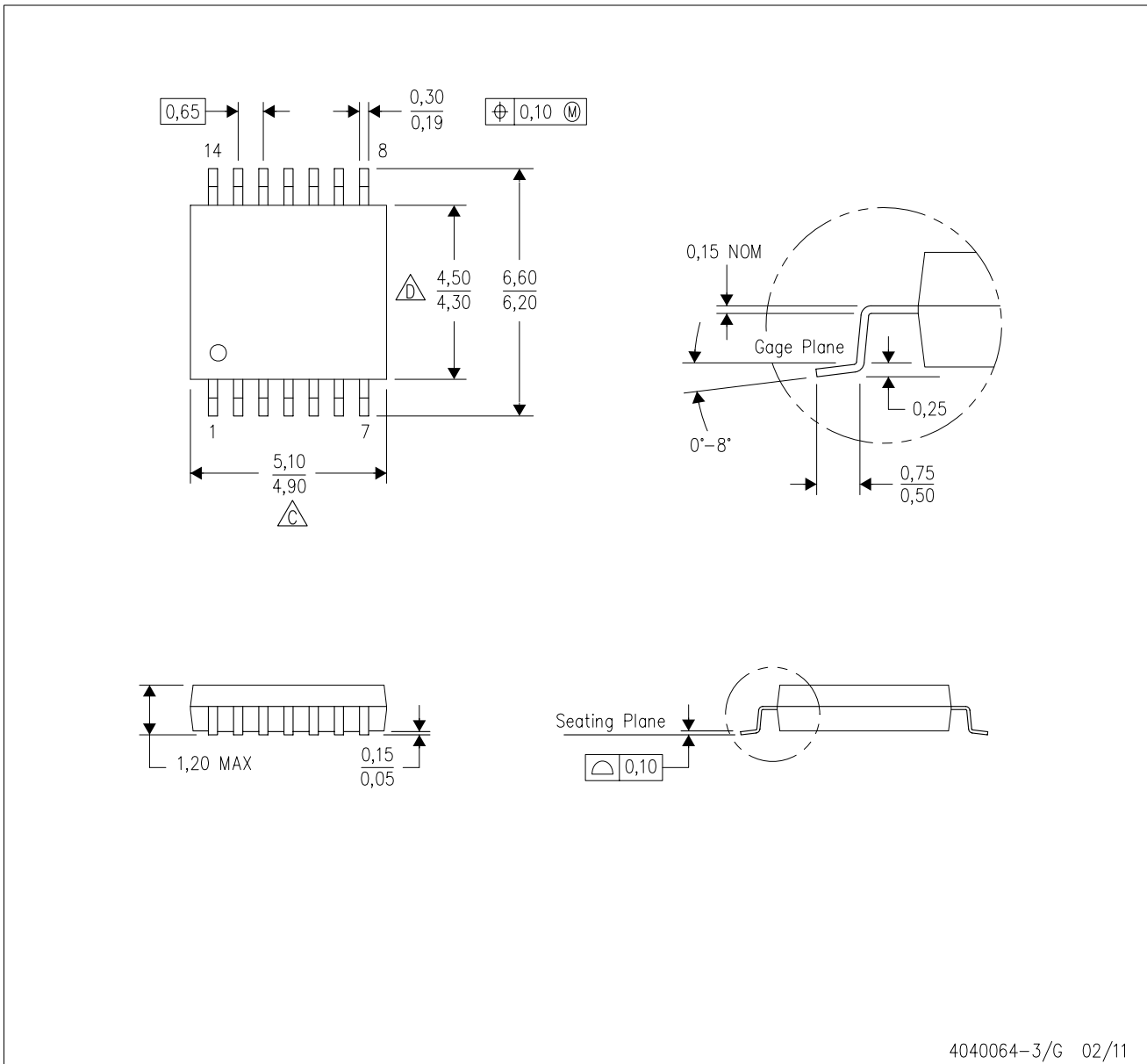

4040064-3/G 02/11

- NOTES:
- A. All linear dimensions are in millimeters. Dimensioning and tolerancing per ASME Y14.5M-1994.
  - B. This drawing is subject to change without notice.
  -  C. Body length does not include mold flash, protrusions, or gate burrs. Mold flash, protrusions, or gate burrs shall not exceed 0,15 each side.
  -  D. Body width does not include interlead flash. Interlead flash shall not exceed 0,25 each side.
  - E. Falls within JEDEC MO-153

D (R-PDSO-G8)

PLASTIC SMALL OUTLINE



- NOTES:
- A. All linear dimensions are in inches (millimeters).
  - B. This drawing is subject to change without notice.
  - Body length does not include mold flash, protrusions, or gate burrs. Mold flash, protrusions, or gate burrs shall not exceed 0.006 (0,15) each side.
  - Body width does not include interlead flash. Interlead flash shall not exceed 0.017 (0,43) each side.
  - E. Reference JEDEC MS-012 variation AA.

## IMPORTANT NOTICE

Texas Instruments Incorporated and its subsidiaries (TI) reserve the right to make corrections, enhancements, improvements and other changes to its semiconductor products and services per JESD46, latest issue, and to discontinue any product or service per JESD48, latest issue. Buyers should obtain the latest relevant information before placing orders and should verify that such information is current and complete. All semiconductor products (also referred to herein as "components") are sold subject to TI's terms and conditions of sale supplied at the time of order acknowledgment.

TI warrants performance of its components to the specifications applicable at the time of sale, in accordance with the warranty in TI's terms and conditions of sale of semiconductor products. Testing and other quality control techniques are used to the extent TI deems necessary to support this warranty. Except where mandated by applicable law, testing of all parameters of each component is not necessarily performed.

TI assumes no liability for applications assistance or the design of Buyers' products. Buyers are responsible for their products and applications using TI components. To minimize the risks associated with Buyers' products and applications, Buyers should provide adequate design and operating safeguards.

TI does not warrant or represent that any license, either express or implied, is granted under any patent right, copyright, mask work right, or other intellectual property right relating to any combination, machine, or process in which TI components or services are used. Information published by TI regarding third-party products or services does not constitute a license to use such products or services or a warranty or endorsement thereof. Use of such information may require a license from a third party under the patents or other intellectual property of the third party, or a license from TI under the patents or other intellectual property of TI.

Reproduction of significant portions of TI information in TI data books or data sheets is permissible only if reproduction is without alteration and is accompanied by all associated warranties, conditions, limitations, and notices. TI is not responsible or liable for such altered documentation. Information of third parties may be subject to additional restrictions.

Resale of TI components or services with statements different from or beyond the parameters stated by TI for that component or service voids all express and any implied warranties for the associated TI component or service and is an unfair and deceptive business practice. TI is not responsible or liable for any such statements.

Buyer acknowledges and agrees that it is solely responsible for compliance with all legal, regulatory and safety-related requirements concerning its products, and any use of TI components in its applications, notwithstanding any applications-related information or support that may be provided by TI. Buyer represents and agrees that it has all the necessary expertise to create and implement safeguards which anticipate dangerous consequences of failures, monitor failures and their consequences, lessen the likelihood of failures that might cause harm and take appropriate remedial actions. Buyer will fully indemnify TI and its representatives against any damages arising out of the use of any TI components in safety-critical applications.

In some cases, TI components may be promoted specifically to facilitate safety-related applications. With such components, TI's goal is to help enable customers to design and create their own end-product solutions that meet applicable functional safety standards and requirements. Nonetheless, such components are subject to these terms.

No TI components are authorized for use in FDA Class III (or similar life-critical medical equipment) unless authorized officers of the parties have executed a special agreement specifically governing such use.

Only those TI components which TI has specifically designated as military grade or "enhanced plastic" are designed and intended for use in military/aerospace applications or environments. Buyer acknowledges and agrees that any military or aerospace use of TI components which have **not** been so designated is solely at the Buyer's risk, and that Buyer is solely responsible for compliance with all legal and regulatory requirements in connection with such use.

TI has specifically designated certain components as meeting ISO/TS16949 requirements, mainly for automotive use. In any case of use of non-designated products, TI will not be responsible for any failure to meet ISO/TS16949.

### Products

|                              |                                                                                      |
|------------------------------|--------------------------------------------------------------------------------------|
| Audio                        | <a href="http://www.ti.com/audio">www.ti.com/audio</a>                               |
| Amplifiers                   | <a href="http://amplifier.ti.com">amplifier.ti.com</a>                               |
| Data Converters              | <a href="http://dataconverter.ti.com">dataconverter.ti.com</a>                       |
| DLP® Products                | <a href="http://www.dlp.com">www.dlp.com</a>                                         |
| DSP                          | <a href="http://dsp.ti.com">dsp.ti.com</a>                                           |
| Clocks and Timers            | <a href="http://www.ti.com/clocks">www.ti.com/clocks</a>                             |
| Interface                    | <a href="http://interface.ti.com">interface.ti.com</a>                               |
| Logic                        | <a href="http://logic.ti.com">logic.ti.com</a>                                       |
| Power Mgmt                   | <a href="http://power.ti.com">power.ti.com</a>                                       |
| Microcontrollers             | <a href="http://microcontroller.ti.com">microcontroller.ti.com</a>                   |
| RFID                         | <a href="http://www.ti-rfid.com">www.ti-rfid.com</a>                                 |
| OMAP Applications Processors | <a href="http://www.ti.com/omap">www.ti.com/omap</a>                                 |
| Wireless Connectivity        | <a href="http://www.ti.com/wirelessconnectivity">www.ti.com/wirelessconnectivity</a> |

### Applications

|                               |                                                                                          |
|-------------------------------|------------------------------------------------------------------------------------------|
| Automotive and Transportation | <a href="http://www.ti.com/automotive">www.ti.com/automotive</a>                         |
| Communications and Telecom    | <a href="http://www.ti.com/communications">www.ti.com/communications</a>                 |
| Computers and Peripherals     | <a href="http://www.ti.com/computers">www.ti.com/computers</a>                           |
| Consumer Electronics          | <a href="http://www.ti.com/consumer-apps">www.ti.com/consumer-apps</a>                   |
| Energy and Lighting           | <a href="http://www.ti.com/energy">www.ti.com/energy</a>                                 |
| Industrial                    | <a href="http://www.ti.com/industrial">www.ti.com/industrial</a>                         |
| Medical                       | <a href="http://www.ti.com/medical">www.ti.com/medical</a>                               |
| Security                      | <a href="http://www.ti.com/security">www.ti.com/security</a>                             |
| Space, Avionics and Defense   | <a href="http://www.ti.com/space-avionics-defense">www.ti.com/space-avionics-defense</a> |
| Video and Imaging             | <a href="http://www.ti.com/video">www.ti.com/video</a>                                   |

### TI E2E Community

[e2e.ti.com](http://e2e.ti.com)