

ACT108-600E

AC Thyristor power switch

Rev. 3 — 13 July 2010

Product data sheet

1. Product profile

1.1 General description

AC Thyristor power switch in a SOT54 plastic package with self-protective capabilities against low and high energy transients

1.2 Features and benefits

- Exclusive negative gate triggering
- Full cycle AC conduction
- Remote gate separates the gate driver from the effects of the load current
- Safe clamping of low energy over-voltage transients
- Self-protective turn-on during high energy voltage transients
- Very high noise immunity

1.3 Applications

- Fan motor circuits
- Lower-power highly inductive, resistive and safety loads
- Pump motor circuits

1.4 Quick reference data

Table 1. Quick reference data

Symbol	Parameter	Conditions	Min	Typ	Max	Unit
V_{DRM}	repetitive peak off-state voltage		-	-	600	V
I_{GT}	gate trigger current	$V_{\text{D}} = 12 \text{ V}; I_{\text{T}} = 100 \text{ mA};$ LD+ G-; $T_{\text{j}} = 25 \text{ }^{\circ}\text{C};$ see Figure 6	1	-	10	mA
		$V_{\text{D}} = 12 \text{ V}; I_{\text{T}} = 100 \text{ mA};$ LD- G-; $T_{\text{j}} = 25 \text{ }^{\circ}\text{C}$	1	-	10	mA
$I_{\text{T(RMS)}}$	RMS on-state current	full sine wave; $T_{\text{lead}} \leq 71 \text{ }^{\circ}\text{C};$ see Figure 2	-	-	0.8	A
dV_{D}/dt	rate of rise of off-state voltage	$V_{\text{DM}} = 402 \text{ V}; T_{\text{j}} = 125 \text{ }^{\circ}\text{C};$ gate open circuit; see Figure 10	1000	-	-	V/ μs
V_{CL}	clamping voltage	$I_{\text{CL}} = 100 \text{ } \mu\text{A}; t_{\text{p}} = 1 \text{ ms};$ $T_{\text{j}} \leq 125 \text{ }^{\circ}\text{C};$ see Figure 13	650	-	-	V
V_{PP}	peak pulse voltage	$T_{\text{j}} = 25 \text{ }^{\circ}\text{C};$ non-repetitive, off-state; see Figure 1	-	-	2	kV
V_{T}	on-state voltage	$I_{\text{T}} = 1.1 \text{ A};$ see Figure 9	-	-	1.3	V



2. Pinning information

Table 2. Pinning information

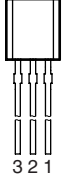
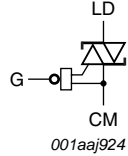
Pin	Symbol	Description	Simplified outline	Graphic symbol
1	CM	common	 <p style="text-align: center;">3 2 1</p> <p style="text-align: center;">SOT54 (TO-92)</p>	 <p style="text-align: center;">001aaJ924</p>
2	G	gate		
3	LD	load		

3. Ordering information

Table 3. Ordering information

Type number	Package		Version
	Name	Description	
ACT108-600E	TO-92	plastic single-ended leaded (through hole) package; 3 leads	SOT54

4. Limiting values

Table 4. Limiting values

In accordance with the Absolute Maximum Rating System (IEC 60134).

Symbol	Parameter	Conditions	Min	Max	Unit
V_{DRM}	repetitive peak off-state voltage		-	600	V
$I_{T(RMS)}$	RMS on-state current	full sine wave; $T_{lead} \leq 71\text{ °C}$; see Figure 2	-	0.8	A
I_{TSM}	non-repetitive peak on-state current	full sine wave; $T_{j(init)} = 25\text{ °C}$; $t_p = 16.7\text{ ms}$	-	8.8	A
		full sine wave; $T_{j(init)} = 25\text{ °C}$; $t_p = 20\text{ ms}$; see Figure 3 ; see Figure 4	-	8	A
I^2t	I^2t for fusing	$t_p = 10\text{ ms}$; sine-wave pulse	-	0.32	A ² s
di_T/dt	rate of rise of on-state current	$I_T = 1\text{ A}$; $I_G = 20\text{ mA}$; $di_G/dt = 0.2\text{ A}/\mu\text{s}$	-	100	A/ μs
I_{GM}	peak gate current	$t = 20\text{ }\mu\text{s}$	-	1	A
V_{GM}	peak gate voltage	positive applied gate voltage	-	15	V
$P_{G(AV)}$	average gate power	over any 20 ms period	-	0.1	W
T_{stg}	storage temperature		-40	150	°C
T_j	junction temperature		-	125	°C
V_{PP}	peak pulse voltage	$T_j = 25\text{ °C}$; non-repetitive, off-state; see Figure 1	-	2	kV

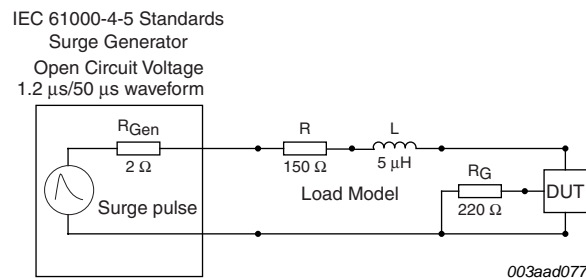

Fig 1. Test circuit for inductive and resistive loads with conditions equivalent to IEC 61000-4-5

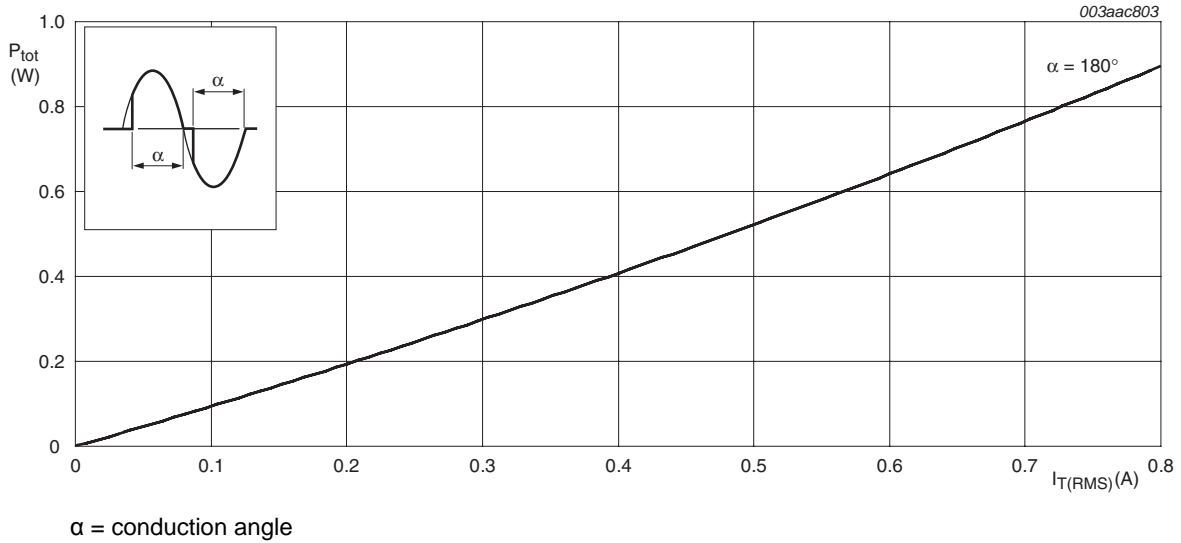

Fig 2. Total power dissipation as a function of RMS on-state current; maximum values

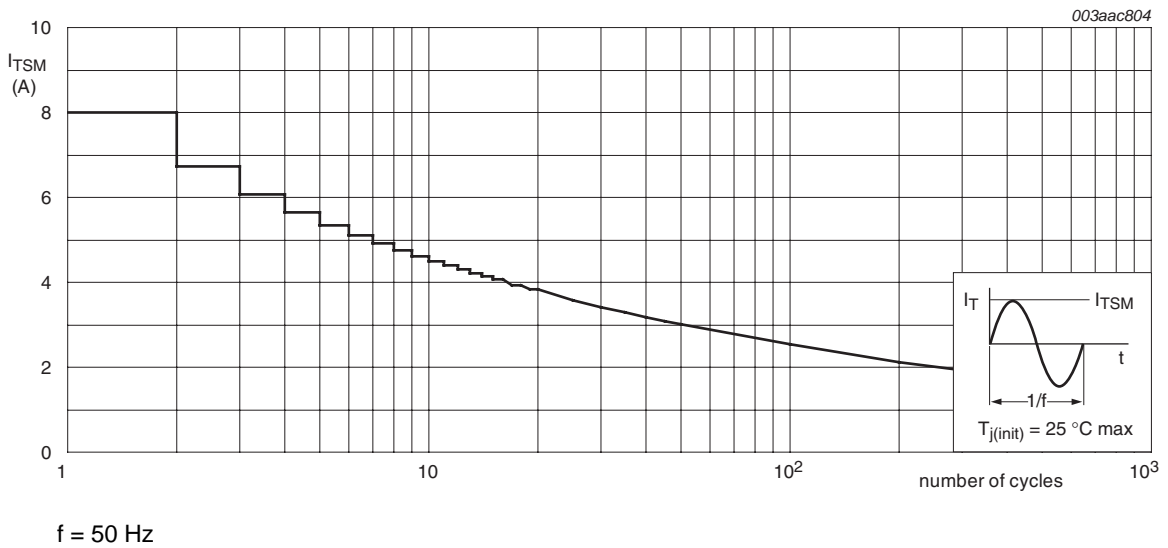
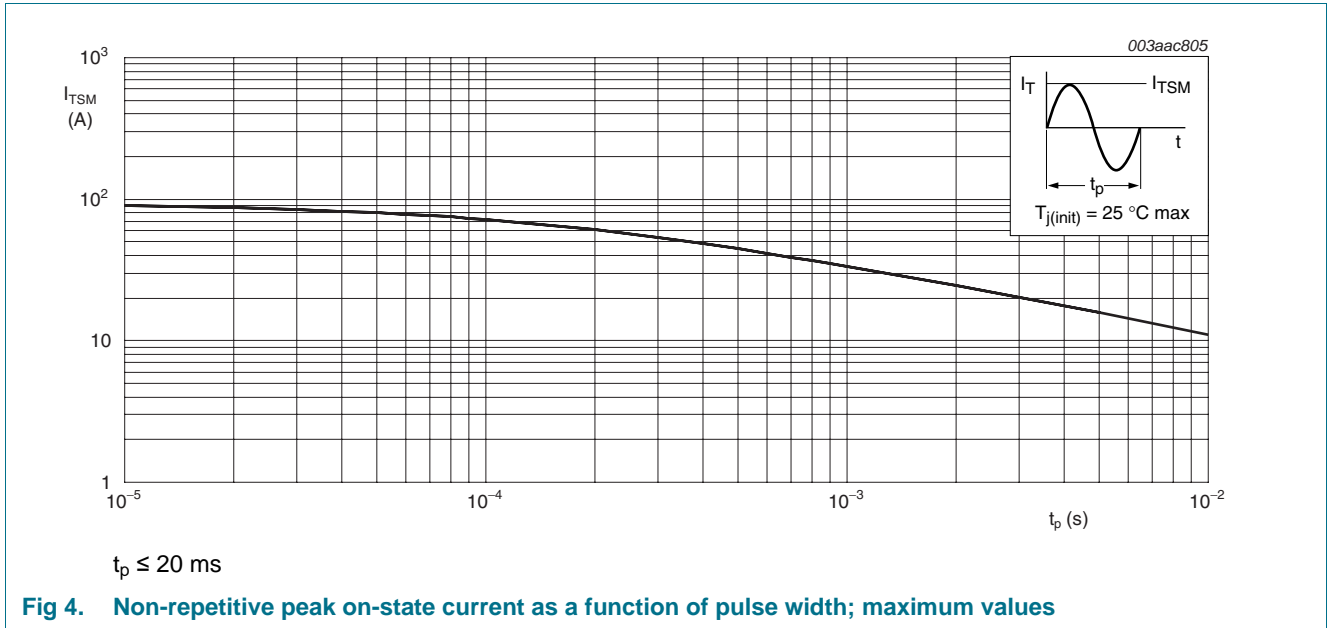

Fig 3. Non-repetitive peak on-state current as a function of the number of sinusoidal current cycles; maximum values



5. Thermal characteristics

Table 5. Thermal characteristics

Symbol	Parameter	Conditions	Min	Typ	Max	Unit
$R_{th(j-lead)}$	thermal resistance from junction to lead	full cycle with heatsink compound; see Figure 5	-	-	60	K/W
$R_{th(j-a)}$	thermal resistance from junction to ambient	full cycle; printed-circuit board mounted; lead length 4 mm	-	150	-	K/W

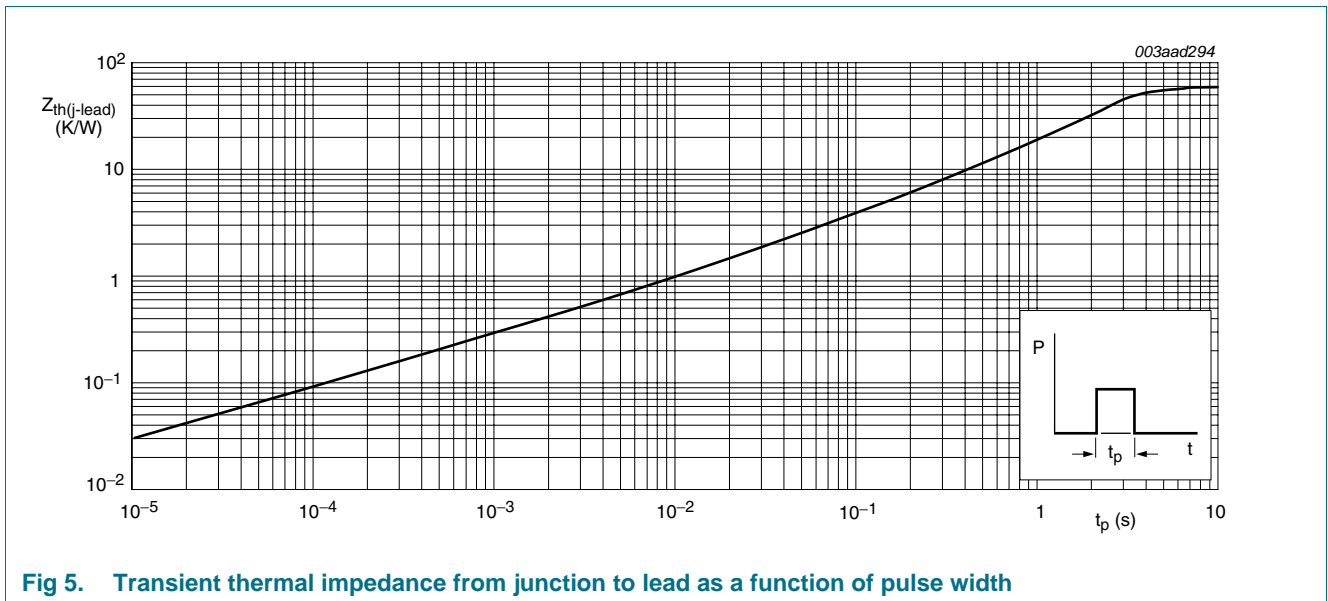

6. Characteristics

Table 6. Characteristics

Symbol	Parameter	Conditions	Min	Typ	Max	Unit
I_{GT}	gate trigger current	$V_D = 12\text{ V}$; $I_T = 100\text{ mA}$; LD+ G-; $T_j = 25\text{ °C}$; see Figure 6	1	-	10	mA
		$V_D = 12\text{ V}$; $I_T = 100\text{ mA}$; LD- G-; $T_j = 25\text{ °C}$	1	-	10	mA
I_L	latching current	$V_D = 12\text{ V}$; $I_G = 12\text{ mA}$; $T_j = 25\text{ °C}$; see Figure 7	-	-	30	mA
I_H	holding current	$V_D = 12\text{ V}$; $T_j = 25\text{ °C}$; see Figure 8	-	9	25	mA
V_T	on-state voltage	$I_T = 1.1\text{ A}$; see Figure 9	-	-	1.3	V
V_{GT}	gate trigger voltage	$V_D = 12\text{ V}$; $I_T = 100\text{ mA}$; $T_j \leq 125\text{ °C}$	0.15	-	-	V
		$V_D = 12\text{ V}$; $I_T = 100\text{ mA}$; $T_j = 25\text{ °C}$	-	-	1	V
I_D	off-state current	$V_D = 600\text{ V}$; $T_j \leq 125\text{ °C}$	-	-	0.2	mA
		$V_D = 600\text{ V}$; $T_j \leq 25\text{ °C}$	-	-	2	μA
dV_D/dt	rate of rise of off-state voltage	$V_{DM} = 402\text{ V}$; $T_j = 125\text{ °C}$; gate open circuit; see Figure 10	1000	-	-	V/ μs
dI_{com}/dt	rate of change of commutating current	$V_D = 400\text{ V}$; $T_j = 125\text{ °C}$; $I_{T(RMS)} = 1\text{ A}$; $dV_{com}/dt = 15\text{ V}/\mu\text{s}$; gate open circuit; see Figure 11 ; see Figure 12	0.3	-	-	A/ms
V_{CL}	clamping voltage	$I_{CL} = 100\text{ }\mu\text{A}$; $t_p = 1\text{ ms}$; $T_j \leq 125\text{ °C}$; see Figure 13	650	-	-	V

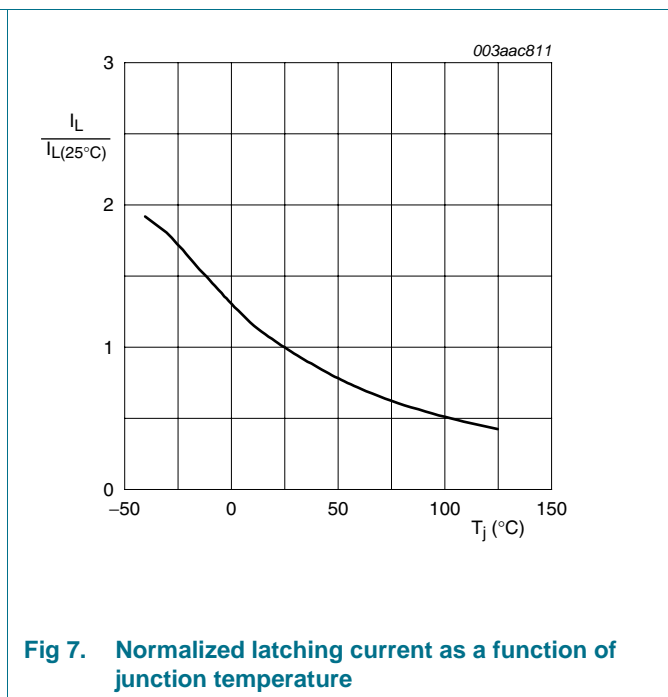
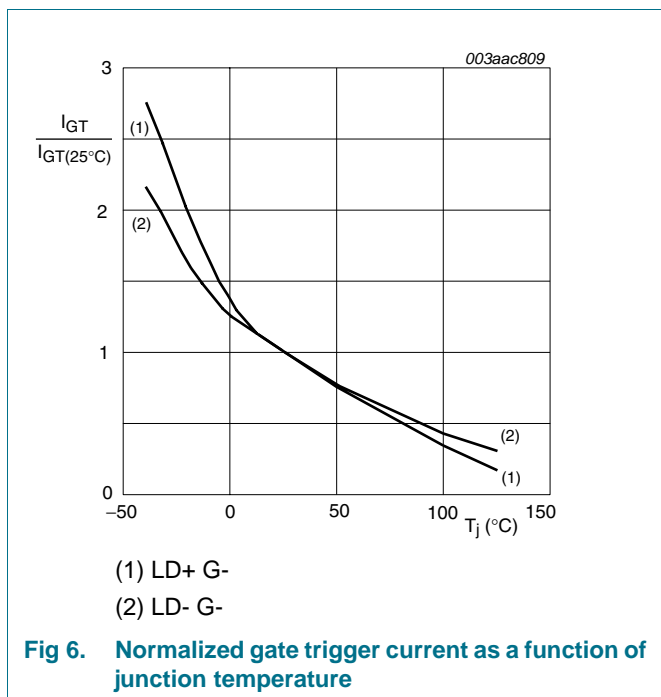

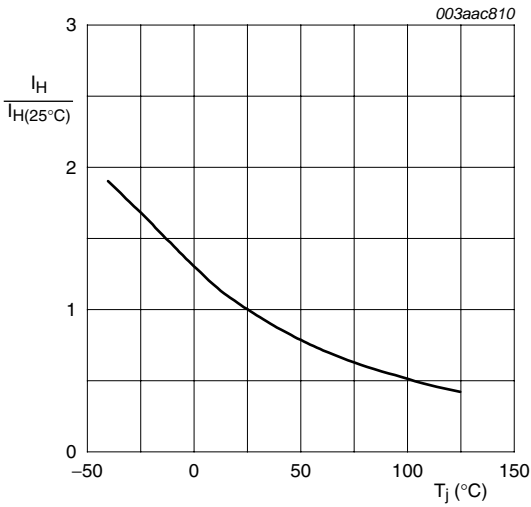
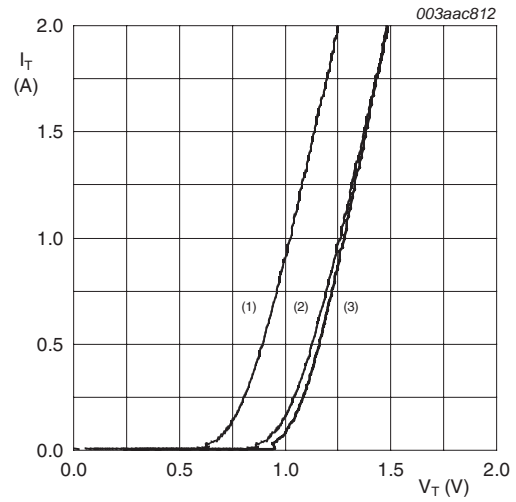

Fig 8. Normalized holding current as a function of junction temperature



$V_O = 0.758 \text{ V}; R_S = 0.263 \Omega$

(1) $T_j = 125 \text{ }^\circ\text{C}$; typical values

(2) $T_j = 125 \text{ }^\circ\text{C}$; maximum values

(3) $T_j = 25 \text{ }^\circ\text{C}$; maximum values

Fig 9. On-state current as a function of on-state voltage

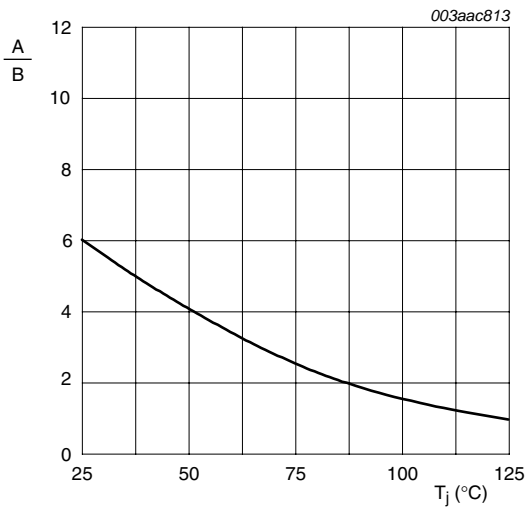

A is dV_D/dt at condition $T_j \text{ }^\circ\text{C}$

B is dV_D/dt at condition $T_j \text{ } 125 \text{ }^\circ\text{C}$

Fig 10. Normalized rate of rise of off-state voltage as a function of junction temperature

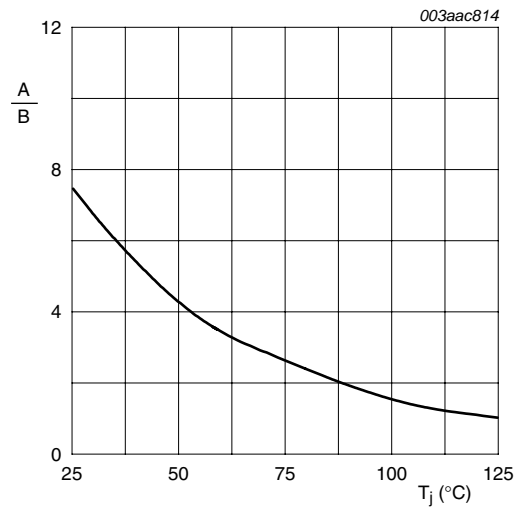

A is di_{com}/dt at condition $T_j \text{ }^\circ\text{C}$

B is di_{com}/dt at condition $T_j \text{ } 125 \text{ }^\circ\text{C}$

$V_D = 400 \text{ V}$

Fig 11. Normalized critical rate of rise of commutating current as a function of junction temperature

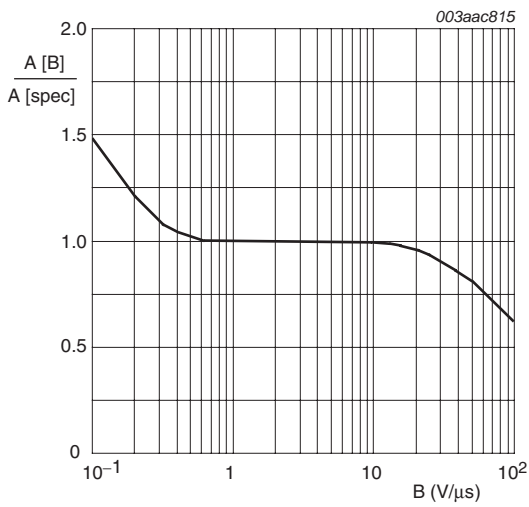

A[B] is dl_{com}/dt at condition B, dV_{com}/dt
 A[spec] is the specified data sheet value of dl_{com}/dt
 turn-off time < 20 ms

Fig 12. Normalized critical rate of change of commutating current as a function of critical rate of change of commutating voltage; minimum values

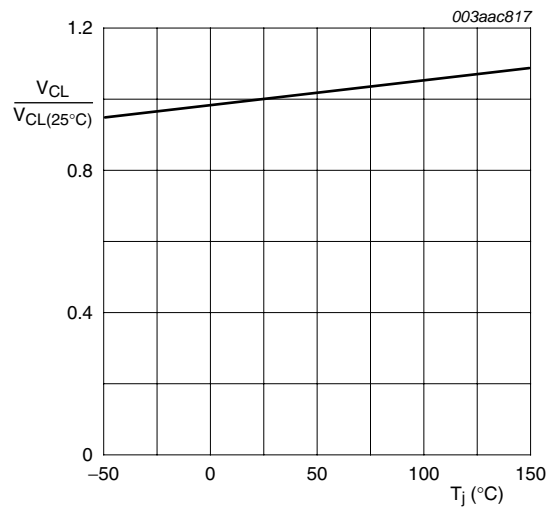

Fig 13. Normalized clamping voltage (upper limit) as a function of junction temperature; minimum values

7. Package outline

Plastic single-ended leaded (through hole) package; 3 leads

SOT54

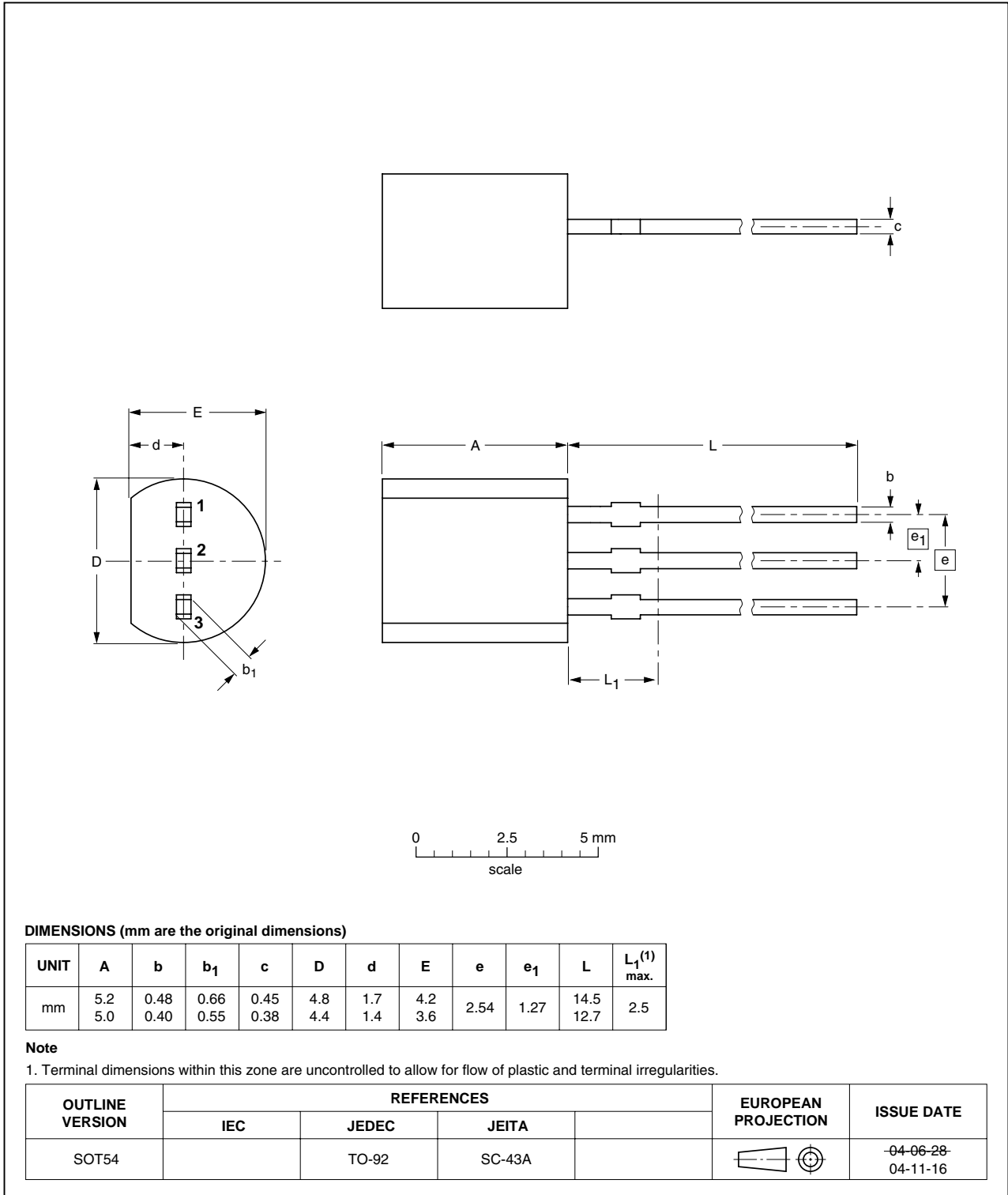

Fig 14. Package outline SOT54 (TO-92)

8. Revision history

Table 7. Revision history

Document ID	Release date	Data sheet status	Change notice	Supersedes
ACT108-600E v.3	20100713	Product data sheet	-	ACT108-600E v.2
Modifications:	• Various changes to content.			
ACT108-600E v.2	20091021	Product data sheet	-	-

9. Legal information

9.1 Data sheet status

Document status ^{[1][2]}	Product status ^[3]	Definition
Objective [short] data sheet	Development	This document contains data from the objective specification for product development.
Preliminary [short] data sheet	Qualification	This document contains data from the preliminary specification.
Product [short] data sheet	Production	This document contains the product specification.

[1] Please consult the most recently issued document before initiating or completing a design.

[2] The term 'short data sheet' is explained in section "Definitions".

[3] The product status of device(s) described in this document may have changed since this document was published and may differ in case of multiple devices. The latest product status information is available on the Internet at URL <http://www.nxp.com>.

9.2 Definitions

Draft — The document is a draft version only. The content is still under internal review and subject to formal approval, which may result in modifications or additions. NXP Semiconductors does not give any representations or warranties as to the accuracy or completeness of information included herein and shall have no liability for the consequences of use of such information.

Short data sheet — A short data sheet is an extract from a full data sheet with the same product type number(s) and title. A short data sheet is intended for quick reference only and should not be relied upon to contain detailed and full information. For detailed and full information see the relevant full data sheet, which is available on request via the local NXP Semiconductors sales office. In case of any inconsistency or conflict with the short data sheet, the full data sheet shall prevail.

Product specification — The information and data provided in a Product data sheet shall define the specification of the product as agreed between NXP Semiconductors and its customer, unless NXP Semiconductors and customer have explicitly agreed otherwise in writing. In no event however, shall an agreement be valid in which the NXP Semiconductors product is deemed to offer functions and qualities beyond those described in the Product data sheet.

9.3 Disclaimers

Limited warranty and liability — Information in this document is believed to be accurate and reliable. However, NXP Semiconductors does not give any representations or warranties, expressed or implied, as to the accuracy or completeness of such information and shall have no liability for the consequences of use of such information.

In no event shall NXP Semiconductors be liable for any indirect, incidental, punitive, special or consequential damages (including - without limitation - lost profits, lost savings, business interruption, costs related to the removal or replacement of any products or rework charges) whether or not such damages are based on tort (including negligence), warranty, breach of contract or any other legal theory.

Notwithstanding any damages that customer might incur for any reason whatsoever, NXP Semiconductors' aggregate and cumulative liability towards customer for the products described herein shall be limited in accordance with the *Terms and conditions of commercial sale* of NXP Semiconductors.

Right to make changes — NXP Semiconductors reserves the right to make changes to information published in this document, including without limitation specifications and product descriptions, at any time and without notice. This document supersedes and replaces all information supplied prior to the publication hereof.

Suitability for use — NXP Semiconductors products are not designed, authorized or warranted to be suitable for use in medical, military, aircraft, space or life support equipment, nor in applications where failure or malfunction of an NXP Semiconductors product can reasonably be expected to result in personal injury, death or severe property or environmental damage. NXP Semiconductors accepts no liability for inclusion and/or use of NXP Semiconductors products in such equipment or applications and therefore such inclusion and/or use is at the customer's own risk.

Applications — Applications that are described herein for any of these products are for illustrative purposes only. NXP Semiconductors makes no representation or warranty that such applications will be suitable for the specified use without further testing or modification.

NXP Semiconductors does not accept any liability related to any default, damage, costs or problem which is based on a weakness or default in the customer application/use or the application/use of customer's third party customer(s) (hereinafter both referred to as "Application"). It is customer's sole responsibility to check whether the NXP Semiconductors product is suitable and fit for the Application planned. Customer has to do all necessary testing for the Application in order to avoid a default of the Application and the product. NXP Semiconductors does not accept any liability in this respect.

Quick reference data — The Quick reference data is an extract of the product data given in the Limiting values and Characteristics sections of this document, and as such is not complete, exhaustive or legally binding. Limiting values — Stress above one or more limiting values (as defined in the Absolute Maximum Ratings System of IEC 60134) will cause permanent damage to the device. Limiting values are stress ratings only and (proper) operation of the device at these or any other conditions above those given in the Recommended operating conditions section (if present) or the Characteristics sections of this document is not warranted. Constant or repeated exposure to limiting values will permanently and irreversibly affect the quality and reliability of the device.

Terms and conditions of commercial sale — NXP Semiconductors products are sold subject to the general terms and conditions of commercial sale, as published at <http://www.nxp.com/profile/terms>, unless otherwise agreed in a valid written individual agreement. In case an individual agreement is concluded only the terms and conditions of the respective agreement shall apply. NXP Semiconductors hereby expressly objects to applying the customer's general terms and conditions with regard to the purchase of NXP Semiconductors products by customer.

No offer to sell or license — Nothing in this document may be interpreted or construed as an offer to sell products that is open for acceptance or the grant, conveyance or implication of any license under any copyrights, patents or other industrial or intellectual property rights.

Export control — This document as well as the item(s) described herein may be subject to export control regulations. Export might require a prior authorization from national authorities.

Non-automotive qualified products — Unless this data sheet expressly states that this specific NXP Semiconductors product is automotive qualified, the product is not suitable for automotive use. It is neither qualified nor tested in accordance with automotive testing or application requirements. NXP Semiconductors accepts no liability for inclusion and/or use of non-automotive qualified products in automotive equipment or applications.

In the event that customer uses the product for design-in and use in automotive applications to automotive specifications and standards, customer (a) shall use the product without NXP Semiconductors' warranty of the product for such automotive applications, use and specifications, and (b) whenever customer uses the product for automotive applications beyond NXP Semiconductors' specifications such use shall be solely at customer's own risk, and (c) customer fully indemnifies NXP Semiconductors for any liability, damages or failed product claims resulting from customer design and use of the product for automotive applications beyond NXP Semiconductors' standard warranty and NXP Semiconductors' product specifications.

10. Contact information

For more information, please visit: <http://www.nxp.com>

For sales office addresses, please send an email to: salesaddresses@nxp.com

9.4 Trademarks

Notice: All referenced brands, product names, service names and trademarks are the property of their respective owners.

Adelante, Bitport, Bitsound, CoolFlux, CoReUse, DESFire, EZ-HV, FabKey, GreenChip, HiPerSmart, HITAG, I²C-bus logo, ICODE, I-CODE, ITEC, Labelution, MIFARE, MIFARE Plus, MIFARE Ultralight, MoReUse, QLPAK, Silicon Tuner, SiliconMAX, SmartXA, STARplug, TOPFET, TrenchMOS, TriMedia and UCODE — are trademarks of NXP B.V.

HD Radio and HD Radio logo — are trademarks of iBiquity Digital Corporation.

11. Contents

1	Product profile	1
1.1	General description	1
1.2	Features and benefits	1
1.3	Applications	1
1.4	Quick reference data	1
2	Pinning information	2
3	Ordering information	2
4	Limiting values	3
5	Thermal characteristics	5
6	Characteristics	6
7	Package outline	9
8	Revision history	10
9	Legal information	11
9.1	Data sheet status	11
9.2	Definitions	11
9.3	Disclaimers	11
9.4	Trademarks	12
10	Contact information	12

Please be aware that important notices concerning this document and the product(s) described herein, have been included in section 'Legal information'.