

BGX7220

Dual receiver down mixer

Rev. 1 — 8 August 2012

Product data sheet

1. General description

The BGX7220 device combines a pair of high performance, high linearity down-mixers for use in receivers having a common local oscillator, for instance having main and diversity paths. The device covers the frequency range from 700 MHz to 950 MHz. Each mixer provides an input 1 dB compression point (ICP_{1dB}) above 13 dBm, with an input third-order intercept point ($IP3_i$) of 26 dBm. The small-signal Noise Figure (NF) is below 10 dB whereas under large signal blocking conditions the Noise Figure is typically 20 dB. Isolation between mixers is typically 55 dB.

2. Features and benefits

- 700 MHz to 950 MHz frequency operating range
- Conversion gain 8 dB in the 900 MHz band
- 13 dBm input power at 1 dB input compression point
- 26 dBm input third-order intercept point
- 10 dB typical small signal noise figure
- Integrated active biasing
- 5 V single supply operation
- Independent power-down hardware control pins per mixer
- Low bias current in Power-down mode
- Matched 50 Ω single-ended RF and LO input impedance
- ESD protection at all pins

3. Applications

- Mobile network infrastructure
- RF and IF applications
- Communication systems and radars
- Microwave and broadband
- Industrial applications

4. Ordering information

Table 1. Ordering information

Type number	Package		Version
	Name	Description	
BGX7220HN	HVQFN36	plastic thermal enhanced very thin quad flat package; no leads; 36 terminals; body 6 × 6 × 0.85 mm	SOT1092-2



5. Functional diagram

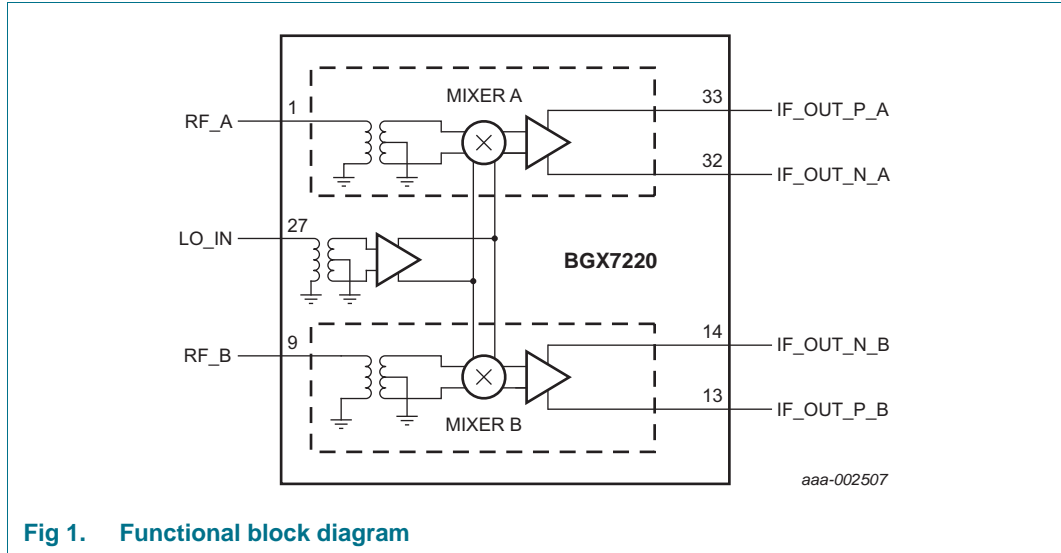

Fig 1. Functional block diagram

Each mixer, A and B employs a transformer to convert the single-ended RF input into a differential signal to drive the passive MOS mixer. The MOS mixer directly drives the IF amplifier. Its open-collector outputs deliver the differential signal into an external transformer load, referenced to the 5 V supply for maximum signal swing. Each mixer can be independently powered-off by a combination of POFF_1 and POFF_2 (see [Table 3.](#)) The dual paths allow diversity operation with a common LO path. A transformer at the LO input converts the single-ended RF into a differential signal to drive the LO buffer chain.

The plastic package has an under-side heat-sink paddle which serves as a good RF ground.

6. Pinning information

6.1 Pinning

Viewing the device from the top (see [Figure 2](#)), the 2 RF input ports are at the left, the common LO input at the right, with IF outputs at the top and bottom. Multiple power and ground pins allow for independent supply domains to improve isolation between blocks.

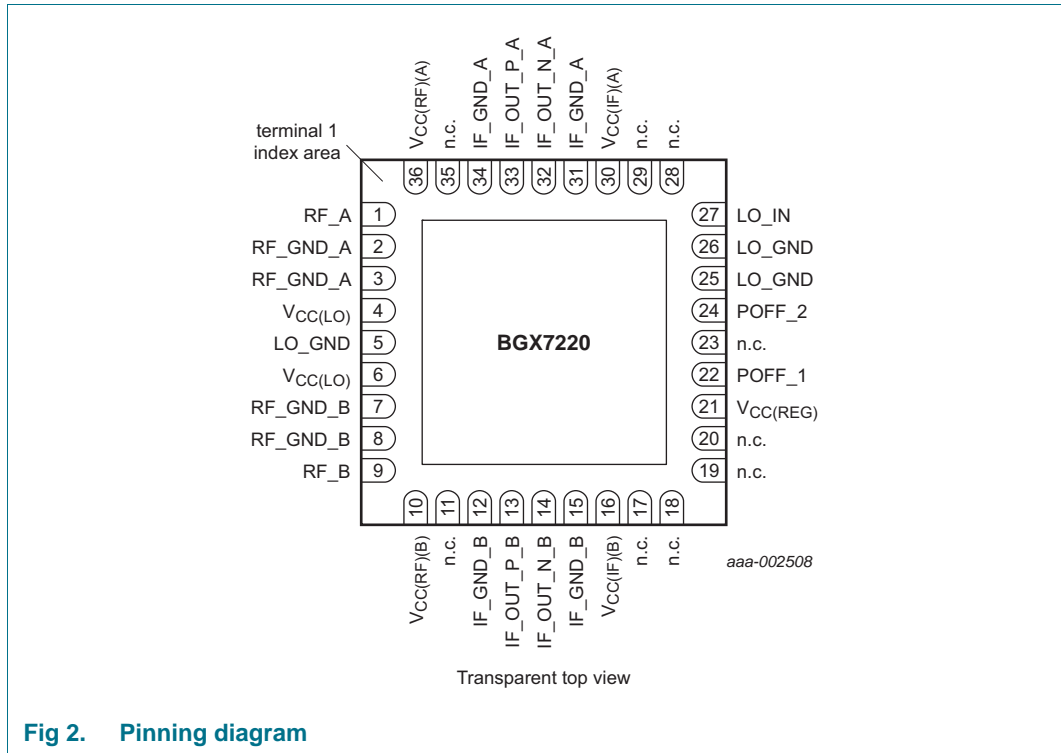

Fig 2. Pinning diagram

6.2 Pin description

Table 2. Pin description

Symbol	Pin	Type ^[1]	Description
RF_A	1	I	receiver mixer single-ended RF input; mixer A
RF_GND_A	2	G	RF ground; mixer A
RF_GND_A	3	G	RF ground; mixer A
V _{CC(LO)}	4	P	LO power supply
LO_GND	5	G	LO ground
V _{CC(LO)}	6	P	LO power supply
RF_GND_B	7	G	RF ground; mixer B
RF_GND_B	8	G	RF ground; mixer B
RF_B	9	I	receiver mixer single-ended RF input; mixer B
V _{CC(RF)(B)}	10	P	RF mixer power supply; mixer B
n.c.	11	-	not connected; to be tied to ground
IF_GND_B	12	G	IF ground; mixer B
IF_OUT_P_B	13	O	symmetrical IF output signal; mixer B
IF_OUT_N_B	14	O	symmetrical IF output signal; mixer B
IF_GND_B	15	G	IF amplifier ground; mixer B
V _{CC(IF)(B)}	16	P	IF amplifier power supply; mixer B
n.c.	17	-	not connected; to be tied to ground
n.c.	18	-	not connected; to be tied to ground
n.c.	19	-	not connected; to be tied to ground
n.c.	20	-	not connected; to be tied to ground
V _{CC(REG)}	21	P	internal regulator power supply

Table 2. Pin description ...continued

Symbol	Pin	Type ^[1]	Description
POFF_1	22	I	logic input to power-off mixer
n.c.	23	-	not connected; to be tied to ground
POFF_2	24	I	logic input to power-off mixer
LO_GND	25	G	LO ground
LO_GND	26	G	LO ground
LO_IN	27	I	single-ended local oscillator positive input
n.c.	28	-	not connected; to be tied to ground
n.c.	29	-	not connected; to be tied to ground
V _{CC(IF)(A)}	30	P	IF amplifier power supply; mixer A
IF_GND_A	31	G	IF amplifier mixer; mixer A
IF_OUT_N_A	32	O	symmetrical IF negative output; mixer A
IF_OUT_P_A	33	O	symmetrical IF positive output; mixer A
IF_GND_A	34	G	IF ground; mixer A
n.c.	35	-	not connected; to be tied to ground
V _{CC(RF)(A)}	36	P	RF power supply; mixer A
Exposed paddle	-	G	exposed paddle; must be connected to RF and DC ground

[1] G: ground; I: input; O: output; P: power.

7. Functional description

7.1 Power-up control

Table 3. Shutdown control

Mode	Description	Function	POFF_1	POFF_2
Active	mixers A and B fully active	shutdown disabled	0	0
Idle	mixers A and B fully off; current supplied to LO buffer	shutdown enabled	1	0
Main	mixer A active; mixer B off	partial shutdown	0	1
Diversity	mixer B active; mixer A off	partial shutdown	1	1

Power-up enable pins to allow each mixer to be placed in Power-down mode. These pins also enable the dedicated LO buffers for individual signal paths. A common LO input stage remains active whatever the state of the power off control inputs, in order to maintain good LO port matching. The time required to pass between active and inactive states is less than 10 μ s. If the pins are left open or tied to ground, both mixers will be in active state.

8. Limiting values

Table 4. Limiting values

In accordance with the Absolute Maximum Rating System (IEC 60134).

Symbol	Parameter	Conditions	Min	Max	Unit
V_{CC}	supply voltage		-0.3	5.5	V
$P_{I(RF)}$	RF input power	continuous	-	20	dBm
P_{tot}	total power dissipation		-	1.96	W
T_{mb}	mounting base temperature		-40	+85	°C
T_j	junction temperature		-	150	°C
T_{stg}	storage temperature		-65	+150	°C
V_{ESD}	electrostatic discharge voltage	EIA/JESD22-A114 (HBM)	-2500	+2500	V
		EIA/JESD22-C101 (FCDM)	-650	+650	V

9. Thermal characteristics

Table 5. Thermal characteristics

Symbol	Parameter	Conditions	Typ	Unit
$R_{th(j-mb)}$	thermal resistance from junction to mounting base	[1]	8	°C/W

[1] Defined according to the conditions described in the Application Note AN11132.

10. Static characteristics

Table 6. Static characteristics

$Z_s = Z_L = 50 \Omega$; $POFF_1 = V_{IL}$ and $POFF_2 = V_{IL}$ (shutdown disabled). Typical values at $V_{CC} = 5$ V, $T_{mb} = 25$ °C, unless otherwise specified.

Symbol	Parameter	Conditions	Min	Typ	Max	Unit
V_{CC}	supply voltage		4.75	5.0	5.25	V
I_{Cq}	quiescent collector current	IF output; per package pin	[1] -	60	-	mA
Shutdown digital input voltage						
V_{IL}	LOW-level input voltage		[1] 0	-	0.5	V
V_{IH}	HIGH-level input voltage		[1] 2	-	5	V
All digital inputs current						
I_{IL}	LOW-level input current		[1] -	1	-	μA
I_{IH}	HIGH-level input current		[1] -	50	-	μA

[1] $V_{CC} = 4.75$ V to 5.25 V, $T_{mb} = -40$ °C to $+85$ °C.

11. Dynamic characteristics

Table 7. Dynamic characteristics

Typical application values: $POFF_1 = V_{IL}$ and $POFF_2 = V_{IL}$ (shutdown disabled); RF and LO ports driven by 50 Ω sources; $P_{i(RF)} = -5$ dBm; $f_{i(RF)} = 850$ MHz; $T_{mb} = -40$ °C to +85 °C; $V_{CC} = 4.75$ V to 5.25 V. Typical values at $V_{CC} = 5$ V; $T_{mb} = 25$ °C; $P_{i(RF)} = -5$ dBm; $P_{i(LO)} = 0$ dBm; $f_{i(RF)} = 850$ MHz; $f_{IF} = 150$ MHz. All parameters are guaranteed by design and characterization, unless otherwise specified.

Symbol	Parameter	Conditions	Min ^[1]	Typ ^[2]	Max ^[1]	Unit
I _{CC}	supply current	both mixers in active mode				
		$f_{lo} = 500$ MHz	-	285	330	mA
		$f_{lo} = 850$ MHz	-	300	345	mA
		$f_{lo} = 1150$ MHz	-	310	355	mA
f _{i(RF)}	RF input frequency		[3] 700	-	950	MHz
f _{lo}	local oscillator frequency	signal from frequency generator; f _{IF} = 50 MHz to 200 MHz	[3] 500	-	1150	MHz
P _{i(lo)}	local oscillator input power	signal from frequency generator	[3] -3	-	+3	dBm
G _{conv}	conversion gain	at T _{mb} = 25 °C; f _{i(RF)} = 700 MHz to 950 MHz	[4] 7.5	8.2	9	dB
$\Delta G/\Delta T$	gain variation with temperature	T _{mb} = -40 °C to +85 °C	-	0.007	-	dB/°C
ΔG	gain deviation	f _{i(RF)} = 700 MHz to 715 MHz; f _{lo} = 560 MHz or f _{lo} = 855 MHz	[4][7] -	0.15	-	dB
		f _{i(RF)} = 750 MHz to 760 MHz; f _{lo} = 605 MHz or f _{lo} = 905 MHz	[4][7] -	0.4	-	dB
		f _{i(RF)} = 780 MHz to 795 MHz; f _{lo} = 640 MHz or f _{lo} = 940 MHz	[4][7] -	0.15	-	dB
		f _{i(RF)} = 815 MHz to 860 MHz; f _{lo} = 690 MHz or f _{lo} = 985 MHz	[4][7] -	0.3	-	dB
		f _{i(RF)} = 880 MHz to 915 MHz; f _{lo} = 750 MHz or f _{lo} = 1045 MHz	[4][7] -	0.15	-	dB
ICP _{1dB}	1 dB input compression point		[6] 10.5	13	-	dBm
IP _{3i}	input third-order intercept point	f _{i(RF)1} to f _{i(RF)2} = 1 MHz; P _{i(RF)} = -5 dBm per tone	[4] 24.5	26	-	dBm
2RF-2LO	second-order spurious rejection	2 tone inputs at P _{i(RF)} = -10 dBm; f _{i(RF)} = 850 MHz; f _{i(LO)} = 950 MHz; f _{i(SPUR)} = 900 MHz	-57	-63	-	dBc
NF _{SSB}	single sideband noise figure		-	9.5	12	dB
NF _B	noise figure under blocking conditions	input in-band blocker +8 dBm; $\Delta f_o = 100$ MHz	[7] -	20	-	dB
$\alpha_{L(RF)lo}$	local oscillator RF leakage	at RF input port; LO input power = 0 dBm	-	-	-35	dBm
$\alpha_{L(IF)lo}$	local oscillator IF leakage	at IF output port; LO input power = 0 dBm	-	-	-35	dBm
α_{isol}	isolation	between mixer A and B; P _{i(RF)} = -10 dBm; measured at unwanted IF port	45	55	-	dB

Table 7. Dynamic characteristics ...continued

Typical application values: $POFF_1 = V_{IL}$ and $POFF_2 = V_{IL}$ (shutdown disabled); RF and LO ports driven by $50\ \Omega$ sources; $P_{i(RF)} = -5\ \text{dBm}$; $f_{i(RF)} = 850\ \text{MHz}$; $T_{mb} = -40\ \text{°C}$ to $+85\ \text{°C}$; $V_{CC} = 4.75\ \text{V}$ to $5.25\ \text{V}$. Typical values at $V_{CC} = 5\ \text{V}$; $T_{mb} = 25\ \text{°C}$; $P_{i(RF)} = -5\ \text{dBm}$; $P_{i(LO)} = 0\ \text{dBm}$; $f_{i(RF)} = 850\ \text{MHz}$; $f_{IF} = 150\ \text{MHz}$. All parameters are guaranteed by design and characterization, unless otherwise specified.

Symbol	Parameter	Conditions	Min ^[1]	Typ ^[2]	Max ^[1]	Unit
S11_RF	RF input return loss	$f_{i(RF)} = 700\ \text{MHz}$ to $950\ \text{MHz}$	-	12	-	dB
S11_LO	LO input return loss	$f_{LO} = 500\ \text{MHz}$ to $1150\ \text{MHz}$	-	12	-	dB
S22_IF	IF output return loss	$f_{IF} = 50\ \text{MHz}$ to $200\ \text{MHz}$	-	14	-	dB

- [1] For all minimum and maximum values the conditions are: $P_{i(RF)} = -5\ \text{dBm}$; $P_{i(LO)} = 0\ \text{dBm}$; $f_{i(RF)} = 850\ \text{MHz}$; $f_{IF} = 150\ \text{MHz}$; $T_{mb} = -40\ \text{°C}$ to $+85\ \text{°C}$; $V_{CC} = 4.75\ \text{V}$ to $5.25\ \text{V}$. Unless otherwise specified in the conditions.
- [2] For all typical values, the conditions are: $P_{i(RF)} = -5\ \text{dBm}$; $P_{LO} = 0\ \text{dBm}$; $f_{i(RF)} = 850\ \text{MHz}$; $f_{IF} = 150\ \text{MHz}$; $T_{mb} = 25\ \text{°C}$; $V_{CC} = 5\ \text{V}$. Unless otherwise specified in the conditions.
- [3] Operation outside this range is possible but parameters are not guaranteed.
- [4] Class A operation.
- [5] f_{IF} is variable.
- [6] Maximum reliable continuous input power applied to the RF or IF port of this device is 12 dBm from a $50\ \Omega$ source.
- [7] NF_B can be improved by 1 dB per dB as a function of the $P_{i(LO)}$.

12. Application information

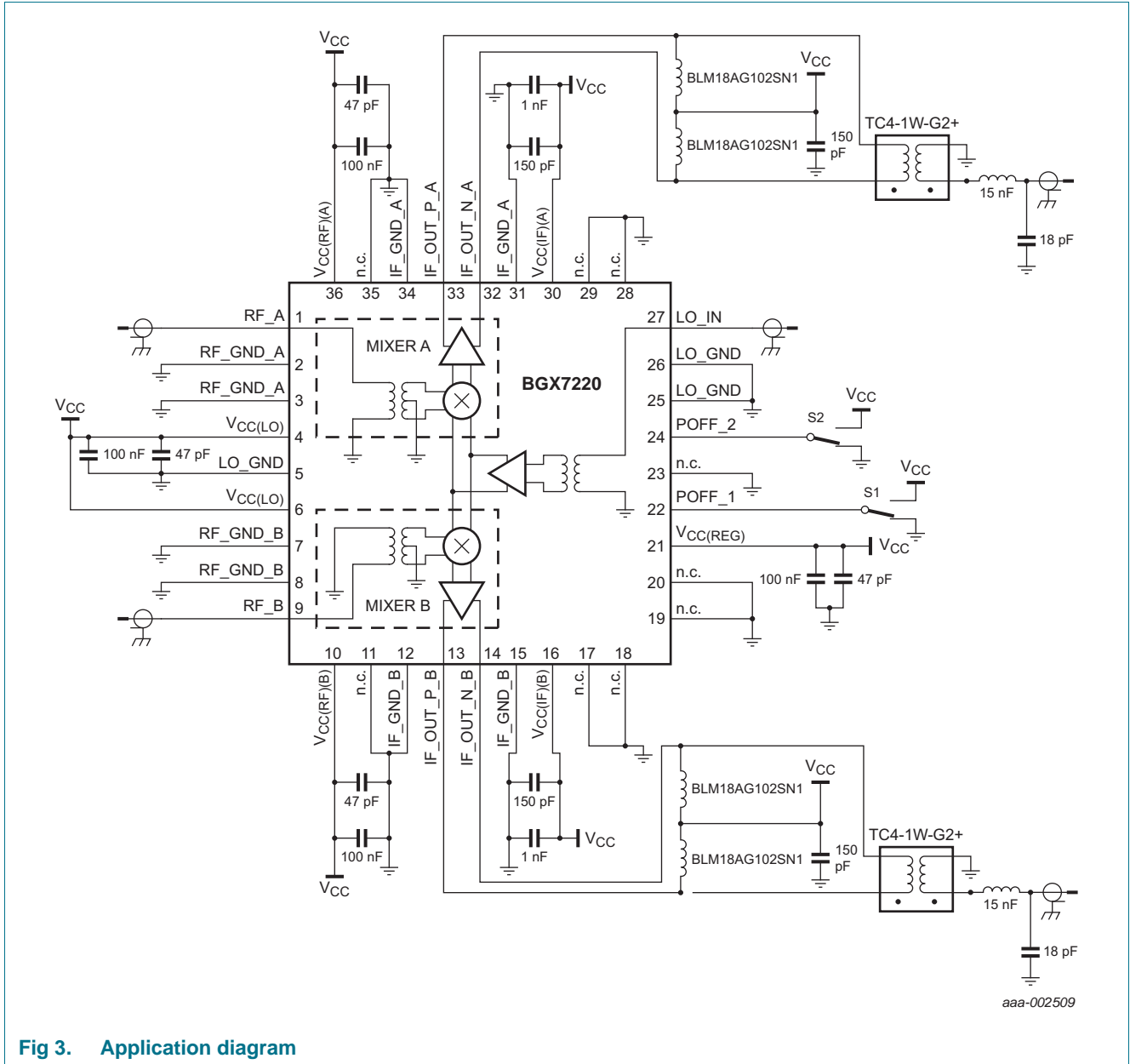
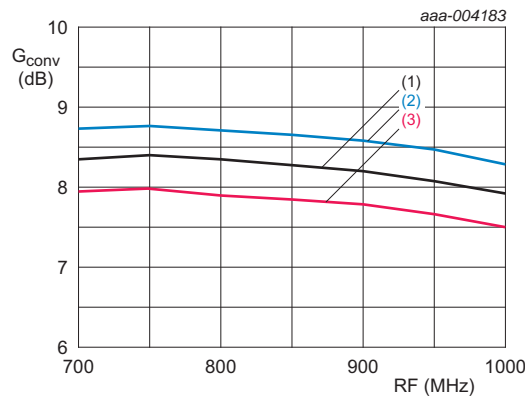

Fig 3. Application diagram

Figure 3 shows a typical wideband application circuit. Both RF and RF reference pins need to be AC coupled. The inputs are internally DC biased in order to provide good ESD protection, and to support large input signals without clamping. The output matching requires a transformer to cope with the DC at the output.

13. Test information

Parameters for the following drawings: $V_{CC} = 5\text{ V}$; $T_{mb} = 25\text{ }^\circ\text{C}$; $P_{i(RF)} = -5\text{ dBm}$; $P_{i(lo)} = 0\text{ dBm}$; $f_{IF} = 150\text{ MHz}$; unless otherwise specified.



- (1) $T_{mb} = +25\text{ }^\circ\text{C}$.
- (2) $T_{mb} = -40\text{ }^\circ\text{C}$.
- (3) $T_{mb} = +85\text{ }^\circ\text{C}$.

Fig 4. G_{conv} versus f_{RF} (high side LO) and T_{mb}

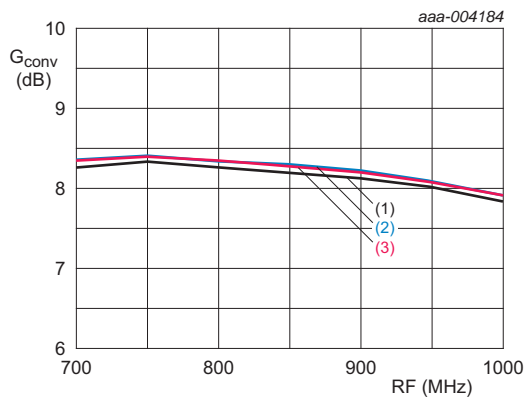

- (1) $P_{i(lo)} = 0\text{ dBm}$.
- (2) $P_{i(lo)} = -3\text{ dBm}$.
- (3) $P_{i(lo)} = +3\text{ dBm}$.

Fig 5. G_{conv} versus f_{RF} (high side LO) and $P_{i(lo)}$

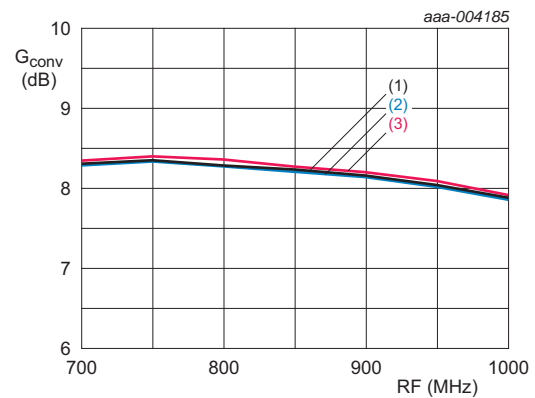

- (1) $V_{CC} = 5\text{ V}$.
- (2) $V_{CC} = 4.75\text{ V}$.
- (3) $V_{CC} = 5.25\text{ V}$.

Fig 6. G_{conv} versus f_{RF} (high side LO) and V_{CC}

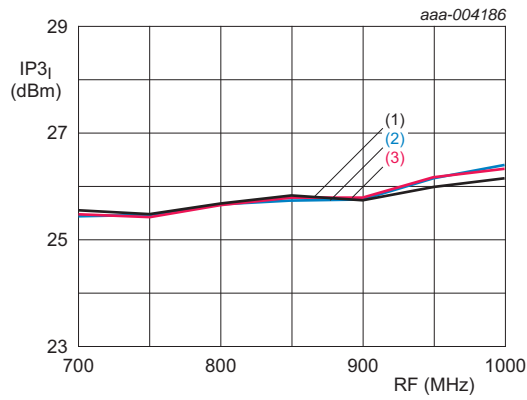

- (1) $T_{mb} = +25\text{ }^{\circ}\text{C}$.
- (2) $T_{mb} = -40\text{ }^{\circ}\text{C}$.
- (3) $T_{mb} = +85\text{ }^{\circ}\text{C}$.

Fig 7. $IP3_i$ versus f_{RF} (high side LO) and T_{mb}

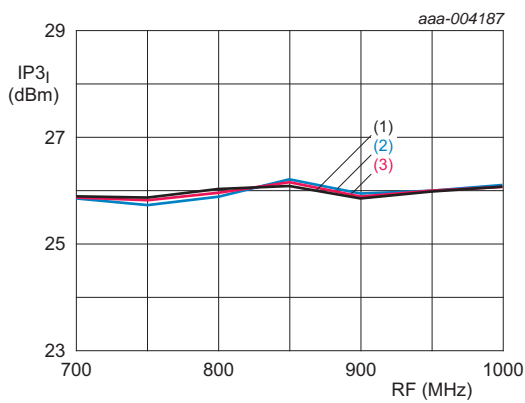

- (1) $P_{i(lo)} = 0\text{ dBm}$.
- (2) $P_{i(lo)} = -3\text{ dBm}$.
- (3) $P_{i(lo)} = +3\text{ dBm}$.

Fig 8. $IP3_i$ versus f_{RF} (high side LO) and $P_{i(lo)}$

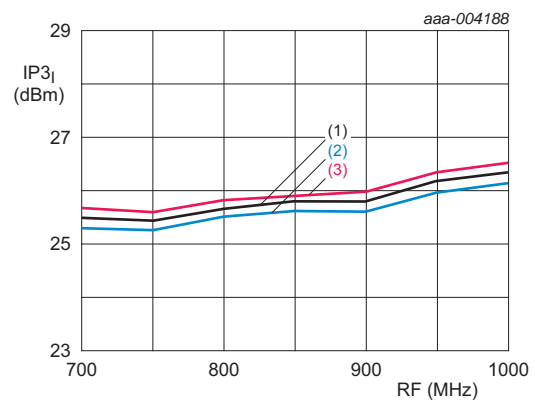

- (1) $V_{CC} = 5\text{ V}$.
- (2) $V_{CC} = 4.75\text{ V}$.
- (3) $V_{CC} = 5.25\text{ V}$.

Fig 9. $IP3_i$ versus f_{RF} (high side LO) and V_{CC}

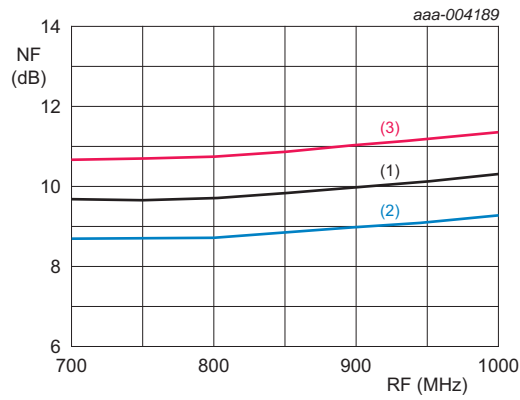

- (1) $T_{mb} = +25^\circ\text{C}$.
- (2) $T_{mb} = -40^\circ\text{C}$.
- (3) $T_{mb} = +85^\circ\text{C}$.

Fig 10. NF versus f_{RF} (high side LO) and T_{mb}

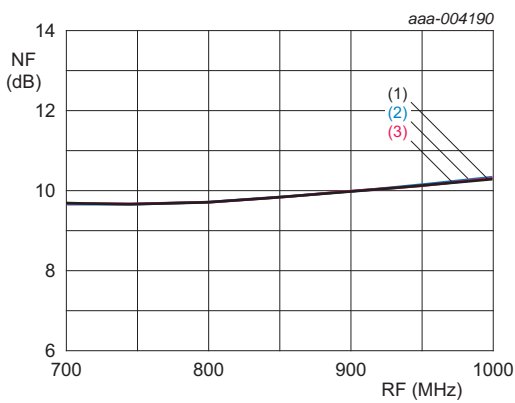

- (1) $P_{i(lo)} = 0\text{ dBm}$.
- (2) $P_{i(lo)} = -3\text{ dBm}$.
- (3) $P_{i(lo)} = +3\text{ dBm}$.

Fig 11. NF versus f_{RF} (high side LO) and $P_{i(lo)}$

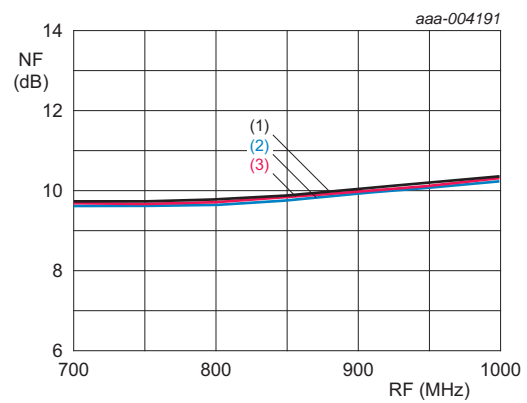

- (1) $V_{CC} = 5\text{ V}$.
- (2) $V_{CC} = 4.75\text{ V}$.
- (3) $V_{CC} = 5.25\text{ V}$.

Fig 12. NF versus f_{RF} (high side LO) and V_{CC}

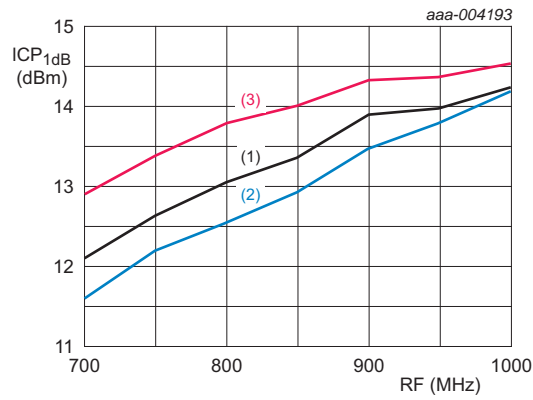

- (1) T_{mb} = +25 °C.
- (2) T_{mb} = -40 °C.
- (3) T_{mb} = +85 °C.

Fig 13. ICP_{1dB} versus f_{RF} (high side LO) and T_{mb}

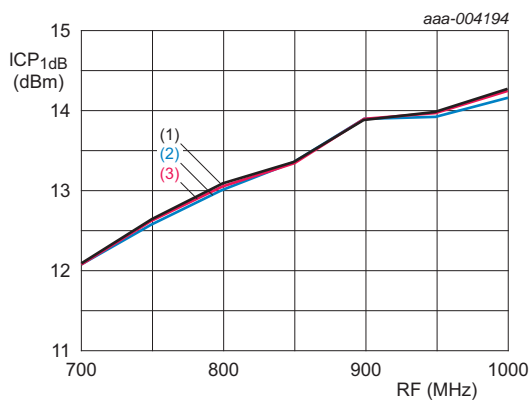

- (1) P_{i(lo)} = 0 dBm.
- (2) P_{i(lo)} = -3 dBm.
- (3) P_{i(lo)} = +3 dBm.

Fig 14. ICP_{1dB} versus f_{RF} (high side LO) and P_{i(lo)}

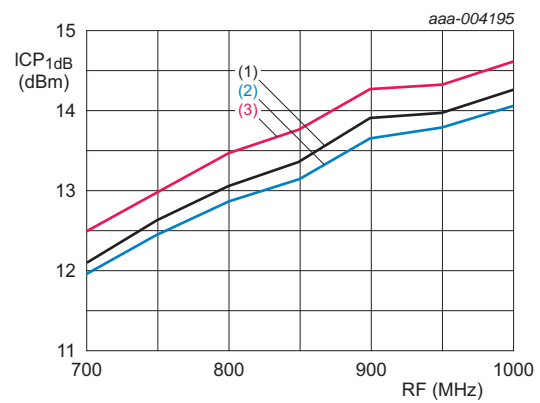

- (1) V_{CC} = 5 V.
- (2) V_{CC} = 4.75 V.
- (3) V_{CC} = 5.25 V.

Fig 15. ICP_{1dB} versus f_{RF} (high side LO) and V_{CC}

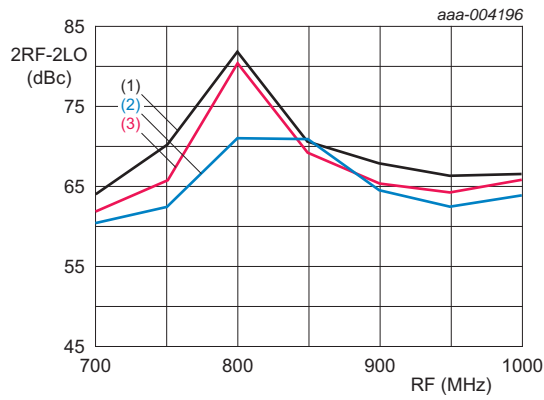

- (1) $T_{mb} = +25\text{ °C}$.
- (2) $T_{mb} = -40\text{ °C}$.
- (3) $T_{mb} = +85\text{ °C}$.

Fig 16. 2RF-2LO response versus f_{RF} (high side LO) and T_{mb}

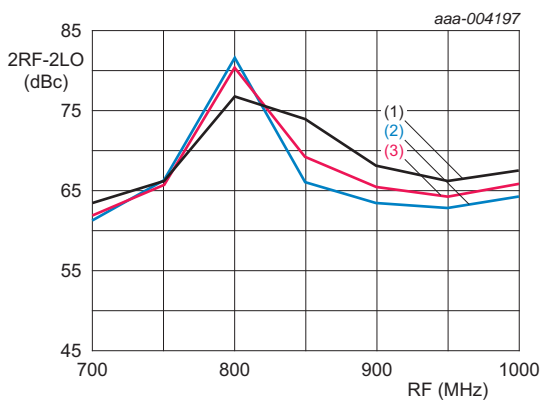

- (1) $P_{i(lo)} = 0\text{ dBm}$.
- (2) $P_{i(lo)} = -3\text{ dBm}$.
- (3) $P_{i(lo)} = +3\text{ dBm}$.

Fig 17. 2RF-2LO response versus f_{RF} (high side LO) and $P_{i(lo)}$

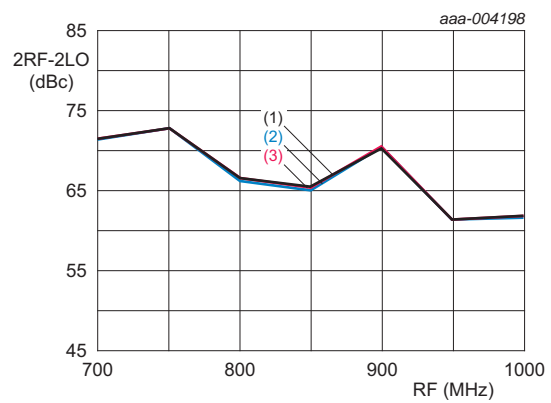

- (1) $V_{CC} = 5\text{ V}$.
- (2) $V_{CC} = 4.75\text{ V}$.
- (3) $V_{CC} = 5.25\text{ V}$.

Fig 18. 2RF-2LO response versus f_{RF} (high side LO) and V_{CC}

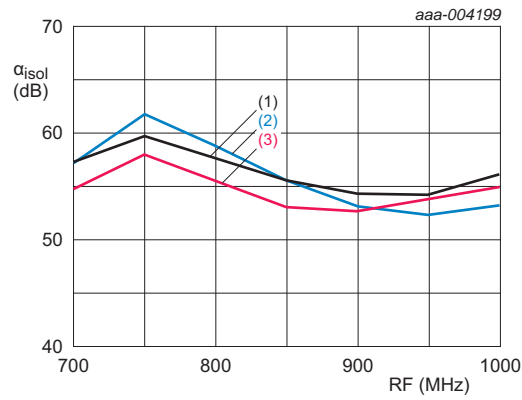

- (1) $T_{mb} = +25\text{ }^{\circ}\text{C}$.
- (2) $T_{mb} = -40\text{ }^{\circ}\text{C}$.
- (3) $T_{mb} = +85\text{ }^{\circ}\text{C}$.

Fig 19. α_{isol} versus f_{RF} (high side LO) and T_{mb}

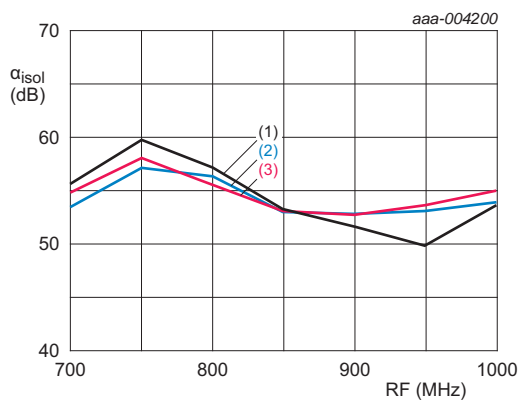

- (1) $P_{i(lo)} = 0\text{ dBm}$.
- (2) $P_{i(lo)} = -3\text{ dBm}$.
- (3) $P_{i(lo)} = +3\text{ dBm}$.

Fig 20. α_{isol} versus f_{RF} (high side LO) and $P_{i(lo)}$

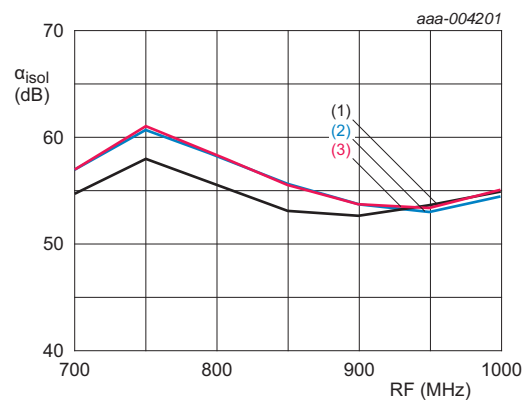

- (1) $V_{CC} = 5\text{ V}$.
- (2) $V_{CC} = 4.75\text{ V}$.
- (3) $V_{CC} = 5.25\text{ V}$.

Fig 21. α_{isol} versus f_{RF} (high side LO) and V_{CC}

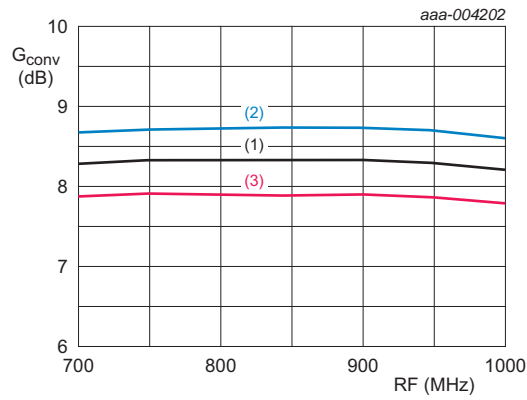

- (1) $T_{mb} = +25\text{ }^{\circ}\text{C}$.
- (2) $T_{mb} = -40\text{ }^{\circ}\text{C}$.
- (3) $T_{mb} = +85\text{ }^{\circ}\text{C}$.

Fig 22. G_{conv} versus f_{RF} (low side LO) and T_{mb}

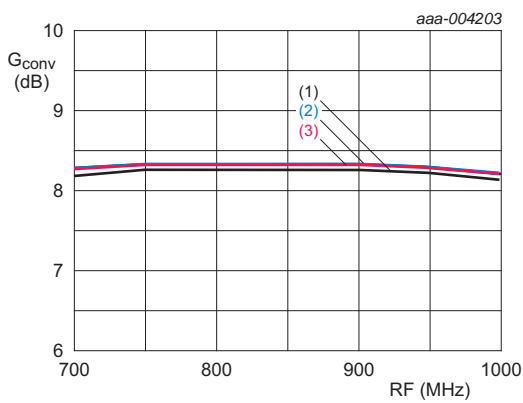

- (1) $P_{i(lo)} = 0\text{ dBm}$.
- (2) $P_{i(lo)} = -3\text{ dBm}$.
- (3) $P_{i(lo)} = +3\text{ dBm}$.

Fig 23. G_{conv} versus f_{RF} (low side LO) and $P_{i(lo)}$

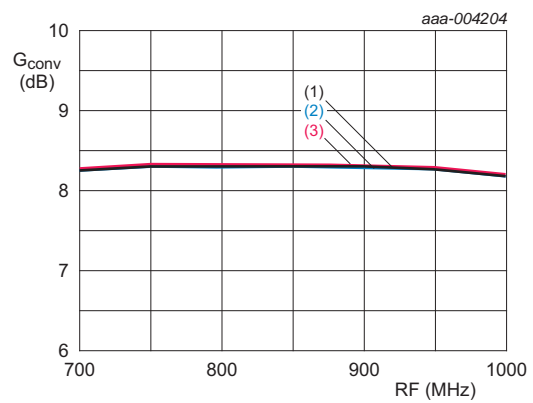

- (1) $V_{CC} = 5\text{ V}$.
- (2) $V_{CC} = 4.75\text{ V}$.
- (3) $V_{CC} = 5.25\text{ V}$.

Fig 24. G_{conv} versus f_{RF} (low side LO) and V_{CC}

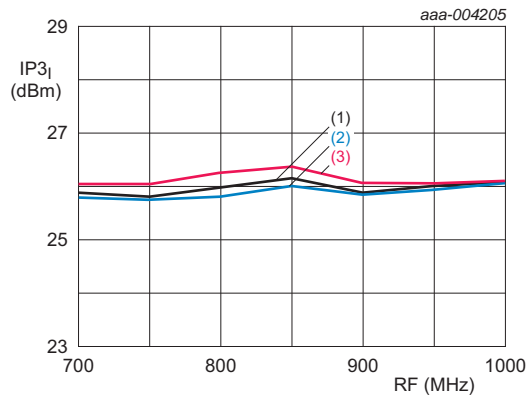

- (1) T_{mb} = +25 °C.
- (2) T_{mb} = -40 °C.
- (3) T_{mb} = +85 °C.

Fig 25. IP_{3i} versus f_{RF} (low side LO) and T_{mb}

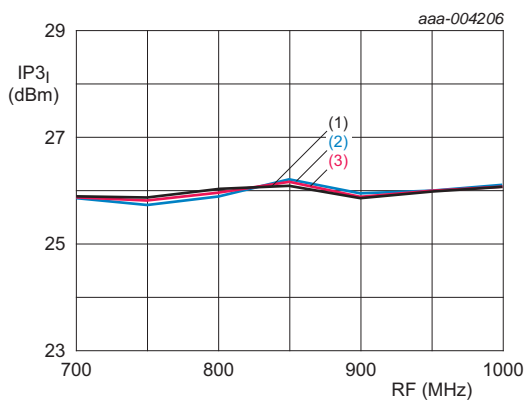

- (1) P_{i(lo)} = 0 dBm.
- (2) P_{i(lo)} = -3 dBm.
- (3) P_{i(lo)} = +3 dBm.

Fig 26. IP_{3i} versus f_{RF} (low side LO) and P_{i(lo)}

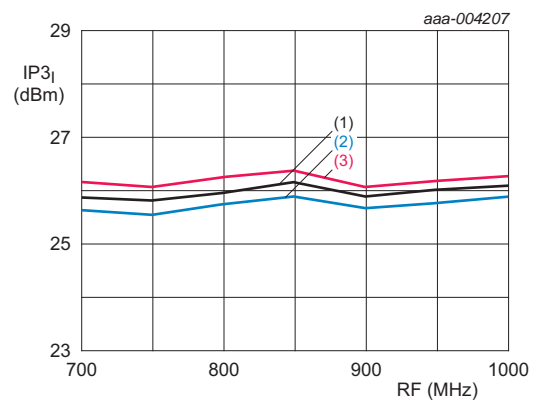

- (1) V_{CC} = 5 V.
- (2) V_{CC} = 4.75 V.
- (3) V_{CC} = 5.25 V.

Fig 27. IP_{3i} versus f_{RF} (low side LO) and V_{CC}

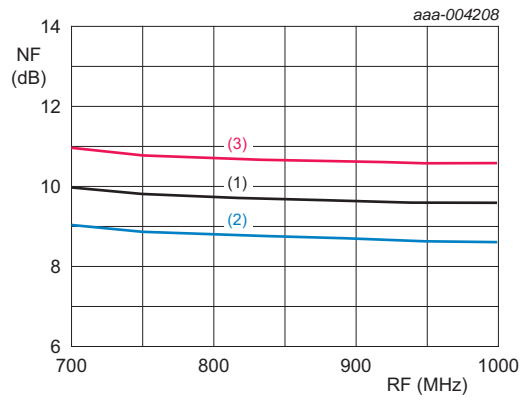

- (1) $T_{mb} = +25\text{ }^{\circ}\text{C}$.
- (2) $T_{mb} = -40\text{ }^{\circ}\text{C}$.
- (3) $T_{mb} = +85\text{ }^{\circ}\text{C}$.

Fig 28. NF versus f_{RF} (low side LO) and T_{mb}

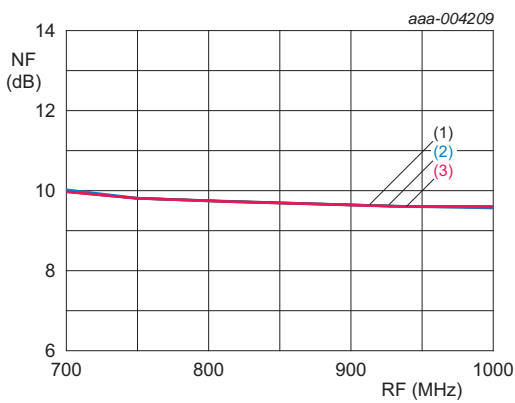

- (1) $P_{i(lo)} = 0\text{ dBm}$.
- (2) $P_{i(lo)} = -3\text{ dBm}$.
- (3) $P_{i(lo)} = +3\text{ dBm}$.

Fig 29. NF versus f_{RF} (low side LO) and $P_{i(lo)}$

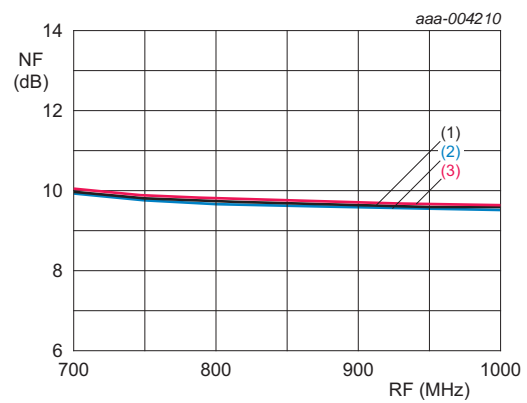

- (1) $V_{CC} = 5\text{ V}$.
- (2) $V_{CC} = 4.75\text{ V}$.
- (3) $V_{CC} = 5.25\text{ V}$.

Fig 30. NF versus f_{RF} (low side LO) and V_{CC}

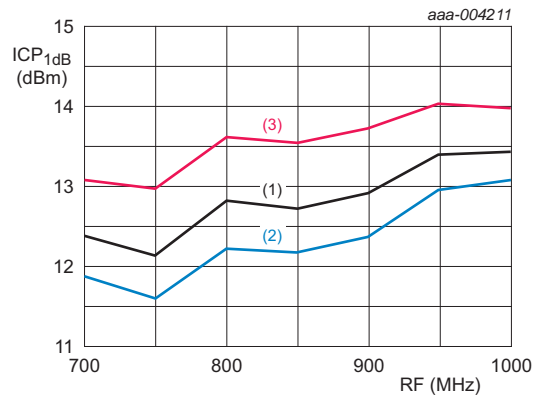

- (1) T_{mb} = +25 °C.
- (2) T_{mb} = -40 °C.
- (3) T_{mb} = +85 °C.

Fig 31. ICP_{1dB} versus f_{RF} (low side LO) and T_{mb}

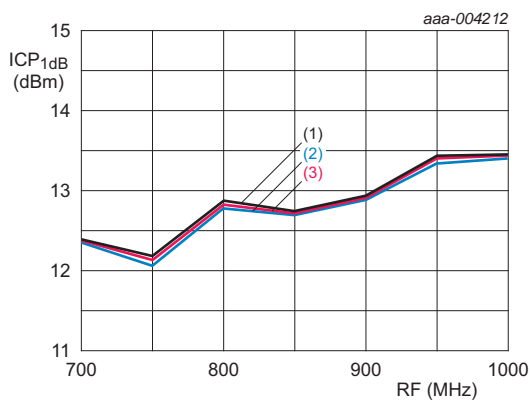

- (1) P_{i(lo)} = 0 dBm.
- (2) P_{i(lo)} = -3 dBm.
- (3) P_{i(lo)} = +3 dBm.

Fig 32. ICP_{1dB} versus f_{RF} (low side LO) and P_{i(lo)}

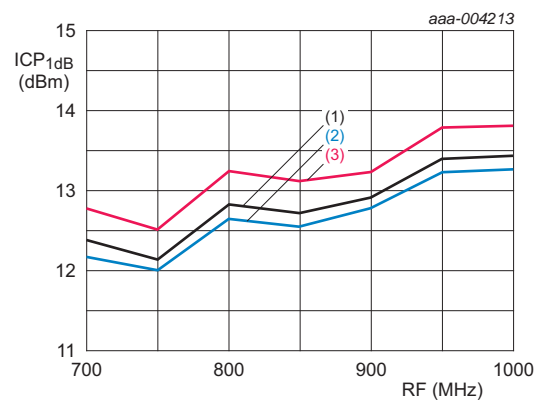

- (1) V_{CC} = 5 V.
- (2) V_{CC} = 4.75 V.
- (3) V_{CC} = 5.25 V.

Fig 33. ICP_{1dB} versus f_{RF} (low side LO) and V_{CC}

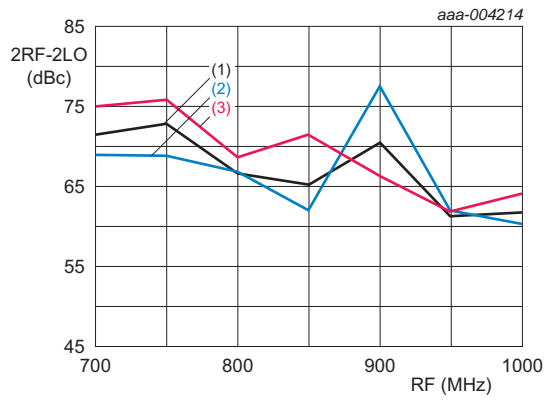

- (1) $T_{mb} = +25\text{ °C}$.
- (2) $T_{mb} = -40\text{ °C}$.
- (3) $T_{mb} = +85\text{ °C}$.

Fig 34. 2RF-2LO response versus f_{RF} (low side LO) and T_{mb}

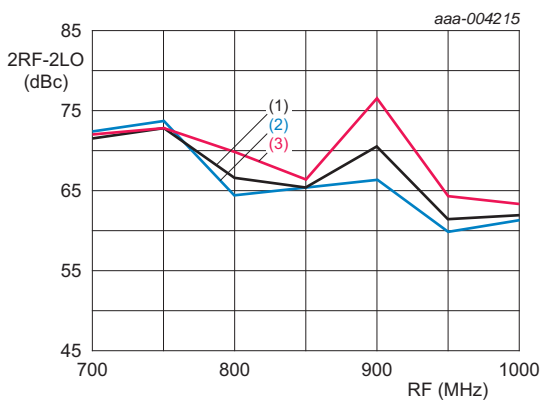

- (1) $P_{i(lo)} = 0\text{ dBm}$.
- (2) $P_{i(lo)} = -3\text{ dBm}$.
- (3) $P_{i(lo)} = +3\text{ dBm}$.

Fig 35. 2RF-2LO response versus f_{RF} (low side LO) and $P_{i(lo)}$

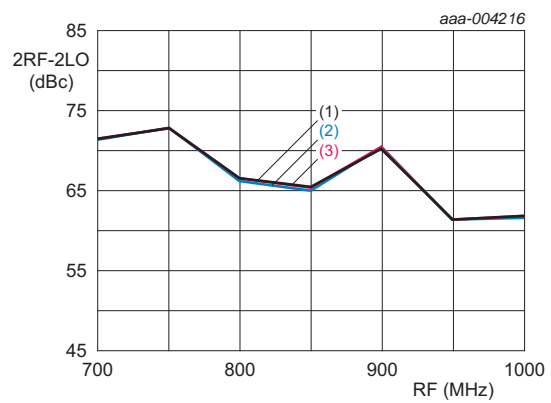

- (1) $V_{CC} = 5\text{ V}$.
- (2) $V_{CC} = 4.75\text{ V}$.
- (3) $V_{CC} = 5.25\text{ V}$.

Fig 36. 2RF-2LO response versus f_{RF} (low side LO) and V_{CC}

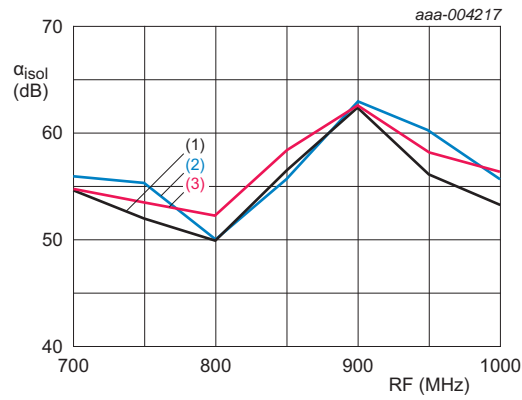

- (1) $T_{mb} = +25\text{ }^{\circ}\text{C}$.
- (2) $T_{mb} = -40\text{ }^{\circ}\text{C}$.
- (3) $T_{mb} = +85\text{ }^{\circ}\text{C}$.

Fig 37. α_{isol} versus f_{RF} (low side LO) and T_{mb}

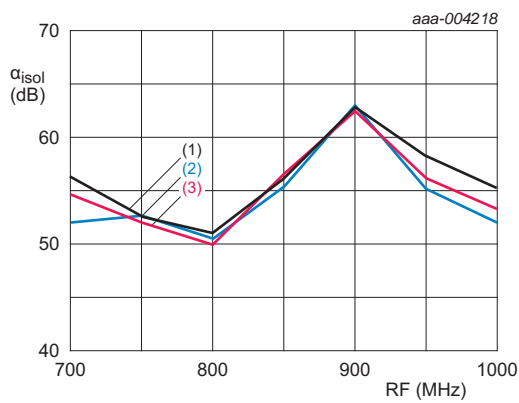

- (1) $P_{i(lo)} = 0\text{ dBm}$.
- (2) $P_{i(lo)} = -3\text{ dBm}$.
- (3) $P_{i(lo)} = +3\text{ dBm}$.

Fig 38. α_{isol} versus f_{RF} (low side LO) and $P_{i(lo)}$

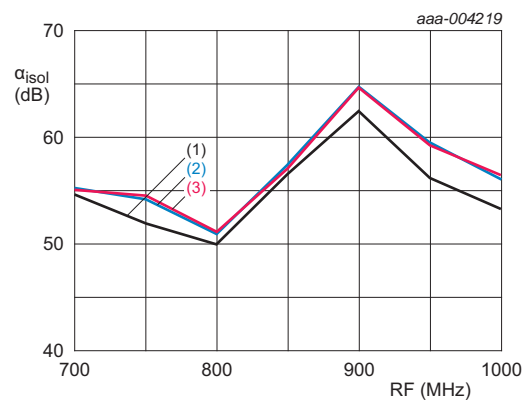

- (1) $V_{CC} = 5\text{ V}$.
- (2) $V_{CC} = 4.75\text{ V}$.
- (3) $V_{CC} = 5.25\text{ V}$.

Fig 39. α_{isol} versus f_{RF} (low side LO) and V_{CC}

14. Package outline

HVQFN36: plastic thermal enhanced very thin quad flat package; no leads;
36 terminals; body 6 x 6 x 0.85 mm

SOT1092-2

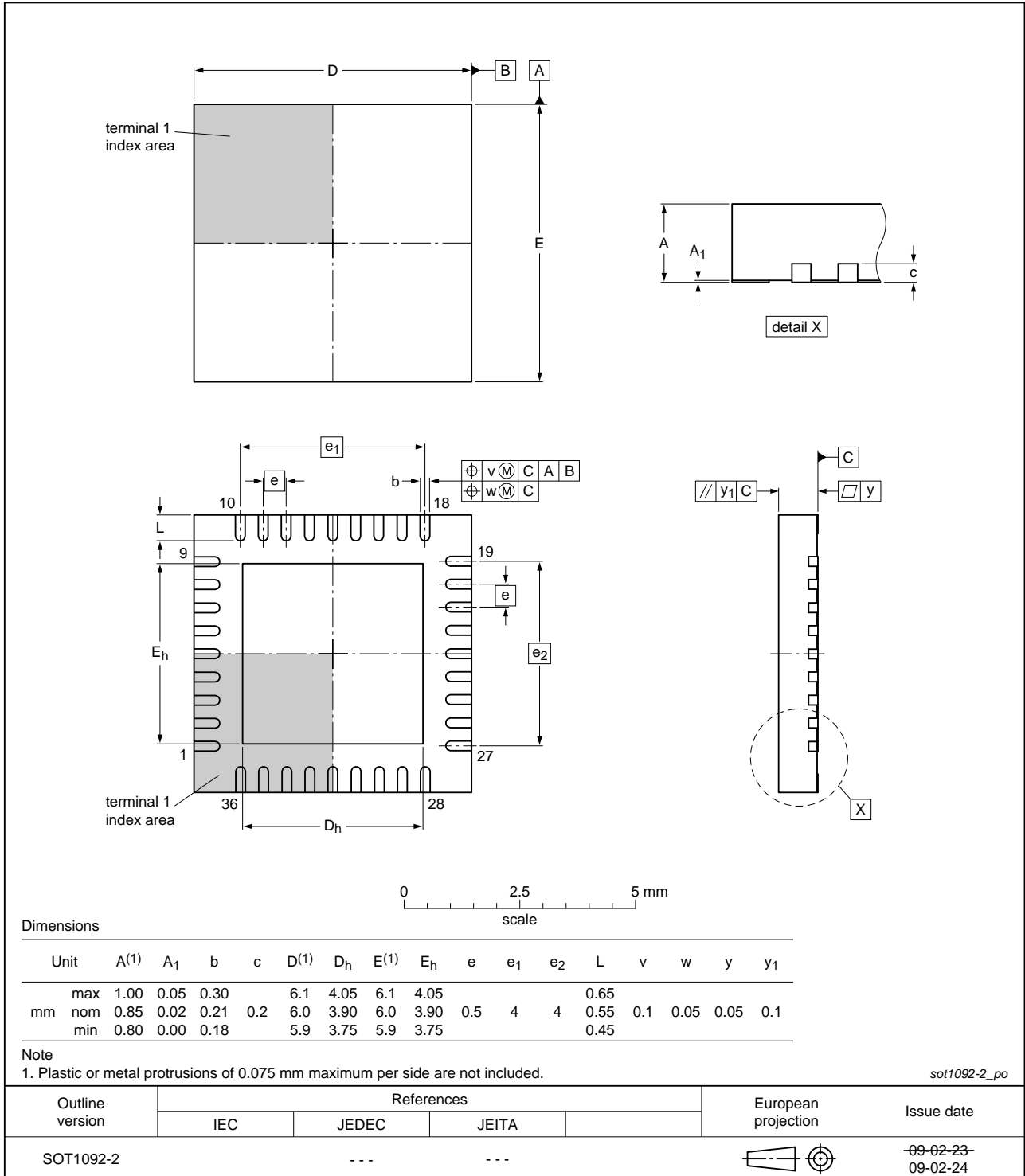

Fig 40. Package outline SOT1092-2 (HVQFN36)

15. Abbreviations

Table 8. Abbreviations

Acronym	Description
AC	Alternating Current
DC	Direct Current
ESD	ElectroStatic Discharge
FCDM	Field-induced Charged-Device Model
HBM	Human Body Model
IF	Intermediate Frequency
LO	Local Oscillator
MOS	Metal-Oxide Semiconductor
PCB	Printed-Circuit Board
RF	Radio Frequency

16. Revision history

Table 9. Revision history

Document ID	Release date	Data sheet status	Change notice	Supersedes
BGX7220 v.1	20120808	Product data sheet	-	-

17. Legal information

17.1 Data sheet status

Document status ^{[1][2]}	Product status ^[3]	Definition
Objective [short] data sheet	Development	This document contains data from the objective specification for product development.
Preliminary [short] data sheet	Qualification	This document contains data from the preliminary specification.
Product [short] data sheet	Production	This document contains the product specification.

[1] Please consult the most recently issued document before initiating or completing a design.

[2] The term 'short data sheet' is explained in section "Definitions".

[3] The product status of device(s) described in this document may have changed since this document was published and may differ in case of multiple devices. The latest product status information is available on the Internet at URL <http://www.nxp.com>.

17.2 Definitions

Draft — The document is a draft version only. The content is still under internal review and subject to formal approval, which may result in modifications or additions. NXP Semiconductors does not give any representations or warranties as to the accuracy or completeness of information included herein and shall have no liability for the consequences of use of such information.

Short data sheet — A short data sheet is an extract from a full data sheet with the same product type number(s) and title. A short data sheet is intended for quick reference only and should not be relied upon to contain detailed and full information. For detailed and full information see the relevant full data sheet, which is available on request via the local NXP Semiconductors sales office. In case of any inconsistency or conflict with the short data sheet, the full data sheet shall prevail.

Product specification — The information and data provided in a Product data sheet shall define the specification of the product as agreed between NXP Semiconductors and its customer, unless NXP Semiconductors and customer have explicitly agreed otherwise in writing. In no event however, shall an agreement be valid in which the NXP Semiconductors product is deemed to offer functions and qualities beyond those described in the Product data sheet.

17.3 Disclaimers

Limited warranty and liability — Information in this document is believed to be accurate and reliable. However, NXP Semiconductors does not give any representations or warranties, expressed or implied, as to the accuracy or completeness of such information and shall have no liability for the consequences of use of such information. NXP Semiconductors takes no responsibility for the content in this document if provided by an information source outside of NXP Semiconductors.

In no event shall NXP Semiconductors be liable for any indirect, incidental, punitive, special or consequential damages (including - without limitation - lost profits, lost savings, business interruption, costs related to the removal or replacement of any products or rework charges) whether or not such damages are based on tort (including negligence), warranty, breach of contract or any other legal theory.

Notwithstanding any damages that customer might incur for any reason whatsoever, NXP Semiconductors' aggregate and cumulative liability towards customer for the products described herein shall be limited in accordance with the *Terms and conditions of commercial sale* of NXP Semiconductors.

Right to make changes — NXP Semiconductors reserves the right to make changes to information published in this document, including without limitation specifications and product descriptions, at any time and without notice. This document supersedes and replaces all information supplied prior to the publication hereof.

Suitability for use — NXP Semiconductors products are not designed, authorized or warranted to be suitable for use in life support, life-critical or safety-critical systems or equipment, nor in applications where failure or malfunction of an NXP Semiconductors product can reasonably be expected to result in personal injury, death or severe property or environmental damage. NXP Semiconductors and its suppliers accept no liability for inclusion and/or use of NXP Semiconductors products in such equipment or applications and therefore such inclusion and/or use is at the customer's own risk.

Applications — Applications that are described herein for any of these products are for illustrative purposes only. NXP Semiconductors makes no representation or warranty that such applications will be suitable for the specified use without further testing or modification.

Customers are responsible for the design and operation of their applications and products using NXP Semiconductors products, and NXP Semiconductors accepts no liability for any assistance with applications or customer product design. It is customer's sole responsibility to determine whether the NXP Semiconductors product is suitable and fit for the customer's applications and products planned, as well as for the planned application and use of customer's third party customer(s). Customers should provide appropriate design and operating safeguards to minimize the risks associated with their applications and products.

NXP Semiconductors does not accept any liability related to any default, damage, costs or problem which is based on any weakness or default in the customer's applications or products, or the application or use by customer's third party customer(s). Customer is responsible for doing all necessary testing for the customer's applications and products using NXP Semiconductors products in order to avoid a default of the applications and the products or of the application or use by customer's third party customer(s). NXP does not accept any liability in this respect.

Limiting values — Stress above one or more limiting values (as defined in the Absolute Maximum Ratings System of IEC 60134) will cause permanent damage to the device. Limiting values are stress ratings only and (proper) operation of the device at these or any other conditions above those given in the Recommended operating conditions section (if present) or the Characteristics sections of this document is not warranted. Constant or repeated exposure to limiting values will permanently and irreversibly affect the quality and reliability of the device.

Terms and conditions of commercial sale — NXP Semiconductors products are sold subject to the general terms and conditions of commercial sale, as published at <http://www.nxp.com/profile/terms>, unless otherwise agreed in a valid written individual agreement. In case an individual agreement is concluded only the terms and conditions of the respective agreement shall apply. NXP Semiconductors hereby expressly objects to applying the customer's general terms and conditions with regard to the purchase of NXP Semiconductors products by customer.

No offer to sell or license — Nothing in this document may be interpreted or construed as an offer to sell products that is open for acceptance or the grant, conveyance or implication of any license under any copyrights, patents or other industrial or intellectual property rights.

Export control — This document as well as the item(s) described herein may be subject to export control regulations. Export might require a prior authorization from competent authorities.

Non-automotive qualified products — Unless this data sheet expressly states that this specific NXP Semiconductors product is automotive qualified, the product is not suitable for automotive use. It is neither qualified nor tested in accordance with automotive testing or application requirements. NXP Semiconductors accepts no liability for inclusion and/or use of non-automotive qualified products in automotive equipment or applications.

In the event that customer uses the product for design-in and use in automotive applications to automotive specifications and standards, customer (a) shall use the product without NXP Semiconductors' warranty of the product for such automotive applications, use and specifications, and (b) whenever customer uses the product for automotive applications beyond

NXP Semiconductors' specifications such use shall be solely at customer's own risk, and (c) customer fully indemnifies NXP Semiconductors for any liability, damages or failed product claims resulting from customer design and use of the product for automotive applications beyond NXP Semiconductors' standard warranty and NXP Semiconductors' product specifications.

Translations — A non-English (translated) version of a document is for reference only. The English version shall prevail in case of any discrepancy between the translated and English versions.

17.4 Trademarks

Notice: All referenced brands, product names, service names and trademarks are the property of their respective owners.

18. Contact information

For more information, please visit: <http://www.nxp.com>

For sales office addresses, please send an email to: salesaddresses@nxp.com

19. Tables

Table 1. Ordering information	1	Table 6. Static characteristics	5
Table 2. Pin description	3	Table 7. Dynamic characteristics	6
Table 3. Shutdown control	4	Table 8. Abbreviations	22
Table 4. Limiting values	5	Table 9. Revision history	22
Table 5. Thermal characteristics	5		

20. Figures

Fig 1. Functional block diagram	2
Fig 2. Pinning diagram	3
Fig 3. Application diagram	8
Fig 4. G_{conv} versus f_{RF} (high side LO) and T_{mb}	9
Fig 5. G_{conv} versus f_{RF} (high side LO) and $P_{i(lo)}$	9
Fig 6. G_{conv} versus f_{RF} (high side LO) and V_{CC}	9
Fig 7. $IP3_i$ versus f_{RF} (high side LO) and T_{mb}	10
Fig 8. $IP3_i$ versus f_{RF} (high side LO) and $P_{i(lo)}$	10
Fig 9. $IP3_i$ versus f_{RF} (high side LO) and V_{CC}	10
Fig 10. NF versus f_{RF} (high side LO) and T_{mb}	11
Fig 11. NF versus f_{RF} (high side LO) and $P_{i(lo)}$	11
Fig 12. NF versus f_{RF} (high side LO) and V_{CC}	11
Fig 13. ICP_{1dB} versus f_{RF} (high side LO) and T_{mb}	12
Fig 14. ICP_{1dB} versus f_{RF} (high side LO) and $P_{i(lo)}$	12
Fig 15. ICP_{1dB} versus f_{RF} (high side LO) and V_{CC}	12
Fig 16. 2RF-2LO response versus f_{RF} (high side LO) and T_{mb}	13
Fig 17. 2RF-2LO response versus f_{RF} (high side LO) and $P_{i(lo)}$	13
Fig 18. 2RF-2LO response versus f_{RF} (high side LO) and V_{CC}	13
Fig 19. a_{isol} versus f_{RF} (high side LO) and T_{mb}	14
Fig 20. a_{isol} versus f_{RF} (high side LO) and $P_{i(lo)}$	14
Fig 21. a_{isol} versus f_{RF} (high side LO) and V_{CC}	14
Fig 22. G_{conv} versus f_{RF} (low side LO) and T_{mb}	15
Fig 23. G_{conv} versus f_{RF} (low side LO) and $P_{i(lo)}$	15
Fig 24. G_{conv} versus f_{RF} (low side LO) and V_{CC}	15
Fig 25. $IP3_i$ versus f_{RF} (low side LO) and T_{mb}	16
Fig 26. $IP3_i$ versus f_{RF} (low side LO) and $P_{i(lo)}$	16
Fig 27. $IP3_i$ versus f_{RF} (low side LO) and V_{CC}	16
Fig 28. NF versus f_{RF} (low side LO) and T_{mb}	17
Fig 29. NF versus f_{RF} (low side LO) and $P_{i(lo)}$	17
Fig 30. NF versus f_{RF} (low side LO) and V_{CC}	17
Fig 31. ICP_{1dB} versus f_{RF} (low side LO) and T_{mb}	18
Fig 32. ICP_{1dB} versus f_{RF} (low side LO) and $P_{i(lo)}$	18
Fig 33. ICP_{1dB} versus f_{RF} (low side LO) and V_{CC}	18
Fig 34. 2RF-2LO response versus f_{RF} (low side LO) and T_{mb}	19
Fig 35. 2RF-2LO response versus f_{RF} (low side LO) and $P_{i(lo)}$	19
Fig 36. 2RF-2LO response versus f_{RF} (low side LO) and V_{CC}	19
Fig 37. a_{isol} versus f_{RF} (low side LO) and T_{mb}	20
Fig 38. a_{isol} versus f_{RF} (low side LO) and $P_{i(lo)}$	20
Fig 39. a_{isol} versus f_{RF} (low side LO) and V_{CC}	20
Fig 40. Package outline SOT1092-2 (HVQFN36)	21

21. Contents

1	General description	1
2	Features and benefits	1
3	Applications	1
4	Ordering information	1
5	Functional diagram	2
6	Pinning information	2
6.1	Pinning	2
6.2	Pin description	3
7	Functional description	4
7.1	Power-up control	4
8	Limiting values	5
9	Thermal characteristics	5
10	Static characteristics	5
11	Dynamic characteristics	6
12	Application information	8
13	Test information	9
14	Package outline	21
15	Abbreviations	22
16	Revision history	22
17	Legal information	23
17.1	Data sheet status	23
17.2	Definitions	23
17.3	Disclaimers	23
17.4	Trademarks	24
18	Contact information	24
19	Tables	25
20	Figures	25
21	Contents	26

Please be aware that important notices concerning this document and the product(s) described herein, have been included in section 'Legal information'.

© NXP B.V. 2012.

All rights reserved.

For more information, please visit: <http://www.nxp.com>

For sales office addresses, please send an email to: salesaddresses@nxp.com

Date of release: 8 August 2012

Document identifier: BGX7220