



# IP4284CZ10-TBR; IP4284CZ10-TT

ESD protection for ultra high-speed interfaces

Rev. 3 — 19 May 2011

Product data sheet

## 1. Product profile

---

### 1.1 General description

The devices are designed to protect high-speed interfaces such as High-Definition Multimedia Interface (HDMI), DisplayPort, SuperSpeed USB, external Serial Advanced Technology Attachment (eSATA) and Low Voltage Differential Signaling (LVDS) interfaces against ElectroStatic Discharge (ESD).

The devices include high-level ESD protection diodes for ultra high-speed signal lines and are available in two package variants: XSON10 and TSSOP10.

All signal lines are protected by a special diode configuration offering ultra low line capacitance of only 0.5 pF. These diodes provide protection to downstream components from ESD voltages up to  $\pm 8$  kV contact according to IEC 61000-4-2, level 4.

### 1.2 Features and benefits

- Pb-free, Restriction of Hazardous Substances (RoHS) compliant and free of halogen and antimony (Dark Green compliant)
- System ESD protection for USB 2.0 and USB SuperSpeed 3.0, HDMI 1.3 and HDMI 1.4, DisplayPort, eSATA and LVDS
- All signal lines with integrated rail-to-rail clamping diodes for downstream ESD protection of  $\pm 8$  kV according to IEC 61000-4-2, level 4
- Matched 0.5 mm trace spacing
- Signal lines with  $\leq 0.05$  pF matching capacitance between signal pairs
- Line capacitance of only 0.5 pF for each channel
- 4-channel, XSON10 or TSSOP10 Pb-free package
- Design-friendly 'pass-thru' signal routing

### 1.3 Applications

The devices are designed for high-speed receiver and transmitter port protection:

- TVs, monitors
- DVD recorders and players
- Notebooks, mother boards, graphic cards and ports
- Set-top boxes and game consoles



## 2. Pinning information

**Table 1. Pinning**

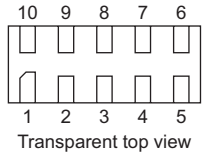
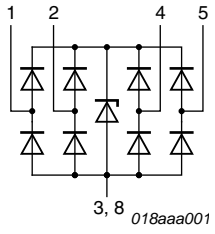
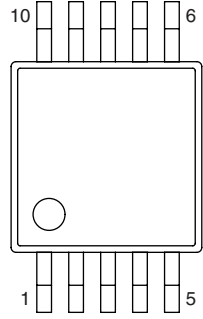
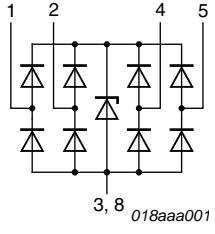
Pin	Symbol	Description	Simplified outline	Graphic symbol
<b>IP4284CZ10-TBR (SOT1176-1)</b>				
1	CH1	channel 1 ESD protection	 <p>Transparent top view <b>XSON10</b></p>	 <p>018aaa001</p>
2	CH2	channel 2 ESD protection		
3	GND	ground		
4	CH3	channel 3 ESD protection		
5	CH4	channel 4 ESD protection		
6	n.c.	not connected		
7	n.c.	not connected		
8	GND	ground		
9	n.c.	not connected		
10	n.c.	not connected		
<b>IP4284CZ10-TT (SOT552-1)</b>				
1	CH1	channel 1 ESD protection	 <p><b>TSSOP10</b></p>	 <p>018aaa001</p>
2	CH2	channel 2 ESD protection		
3	GND	ground		
4	CH3	channel 3 ESD protection		
5	CH4	channel 4 ESD protection		
6	n.c.	not connected		
7	n.c.	not connected		
8	GND	ground		
9	n.c.	not connected		
10	n.c.	not connected		

## 3. Ordering information

**Table 2. Ordering information**

Type number	Package		
	Name	Description	Version
IP4284CZ10-TBR	XSON10	plastic extremely thin small outline package; no leads; 10 terminals; body 1 × 2.5 × 0.5 mm	SOT1176-1
IP4284CZ10-TT	TSSOP10	plastic thin shrink small outline package; 10 leads; body width 3 mm	SOT552-1

## 4. Marking

**Table 3. Marking codes**

Type number	Marking code
IP4284CZ10-TBR	84
IP4284CZ10-TT	4284

## 5. Limiting values

**Table 4. Limiting values**

In accordance with the Absolute Maximum Rating System (IEC 60134).

Symbol	Parameter	Conditions	Min	Max	Unit
$V_I$	input voltage		-0.5	+5.5	V
$V_{ESD}$	electrostatic discharge voltage	IEC 61000-4-2, level 4 [1]			
		contact discharge	-	±8	kV
		air discharge	-	±15	kV
$T_{amb}$	ambient temperature		-40	+85	°C
$T_{stg}$	storage temperature		-55	+125	°C

[1] All pins to ground.

## 6. Characteristics

**Table 5. Characteristics**

$T_{amb} = 25\text{ °C}$  unless otherwise specified.

Symbol	Parameter	Conditions	Min	Typ	Max	Unit
$V_{BRzd}$	Zener diode breakdown voltage	$I_{test} = 1\text{ mA}$	6	-	9	V
$I_{LRzd}$	Zener diode reverse leakage current	per TMDS channel; $V_I = 3.0\text{ V}$	-	-	1	μA
$V_F$	forward voltage		-	0.7	-	V
$C_{ch(TMDS)}$	TMDS channel capacitance	$f = 1\text{ MHz};$ $V_{bias} = 2.5\text{ V}$	[1] 0.4	0.5	0.7	pF
$\Delta C_{ch(TMDS)}$	TMDS channel capacitance difference	$f = 1\text{ MHz};$ $V_{bias} = 2.5\text{ V}$	[1] -	0.05	-	pF
$C_{ch(mutual)}$	mutual channel capacitance	$f = 1\text{ MHz};$ $V_{bias} = 2.5\text{ V}$	[1][2] -	0.07	-	pF
$R_{dyn}$	dynamic resistance	$I = 1\text{ A}$ [3]				
		positive transient	-	1	-	Ω
		negative transient	-	1	-	Ω
$V_{CL(ch)trt(pos)}$	positive transient channel clamping voltage	$V_{ESD} = 8\text{ kV}$	[4] -	8	-	V

[1] This parameter is guaranteed by design.

[2] Between signal pin and pin n.c.

[3] According to IEC 61000-4-5 and IEC 61000-4-9.

[4] Human Body Model (HBM) according to JESD22-A-J114D.

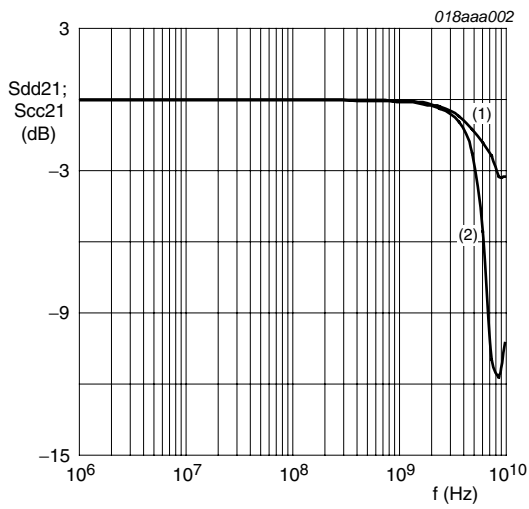

- (1) Sdd21
  - (2) Scc21
- normalized to 100 Ω;  
differential pairs at CH1/CH2 or at CH3/CH4

**Fig 1. Mixed-mode differential and common-mode insertion loss; typical values**

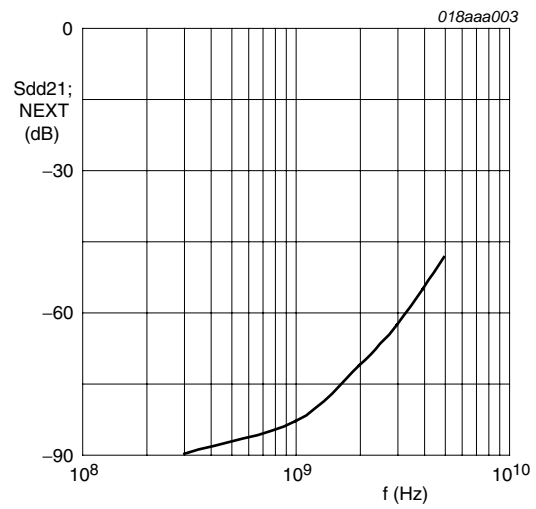

Sdd21  
normalized to 100 Ω;  
differential pairs CH1/CH2 versus CH3/CH4

**Fig 2. Mixed-mode differential NEXT crosstalk; typical values**

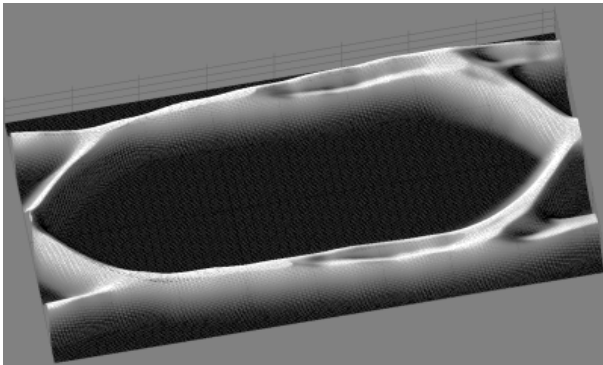

018aaa004

5 Gbit/s; USB 3.0 CP0 pattern

Fig 3. Eye diagram using reference PCB

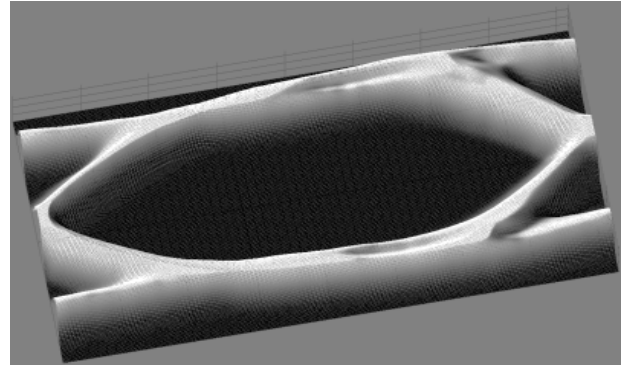

018aaa005

5 Gbit/s; USB 3.0 CP0 pattern

Fig 4. Typical eye diagram for IP4284CZ10

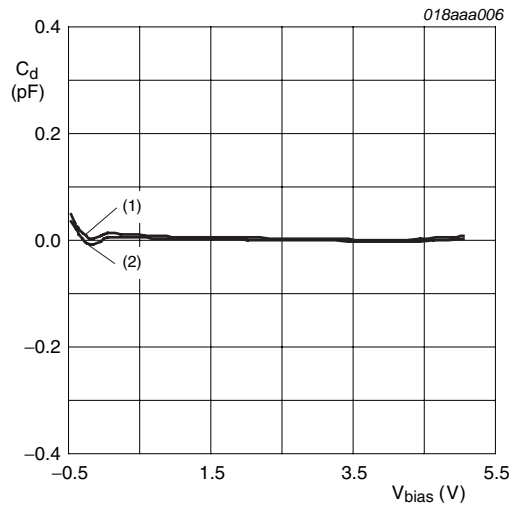

018aaa006

- (1) Pin 2
- (2) Pin 1

Deviation from typical capacitance normalized at  $V_{bias} = 2.5\text{ V}$

Fig 5. Line capacitance as a function of bias voltage; typical values

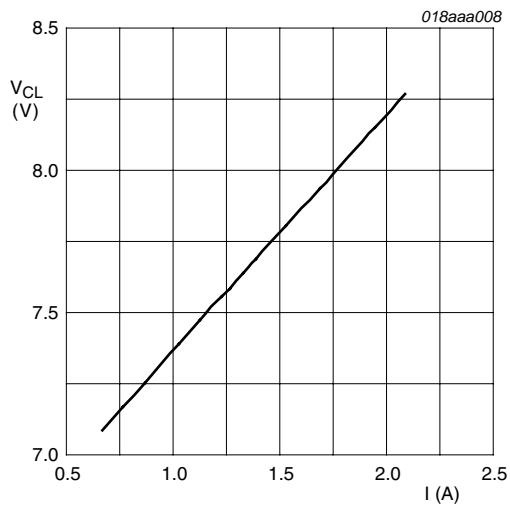

IEC 61000-4-5;  $t_p = 8/20 \mu s$ ; positive pulse

Fig 6. Dynamic resistance with positive clamping

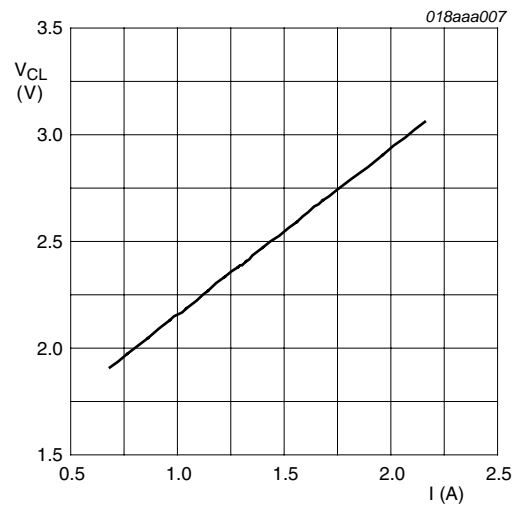

IEC 61000-4-5;  $t_p = 8/20 \mu s$ ; negative pulse

Fig 7. Dynamic resistance with negative clamping

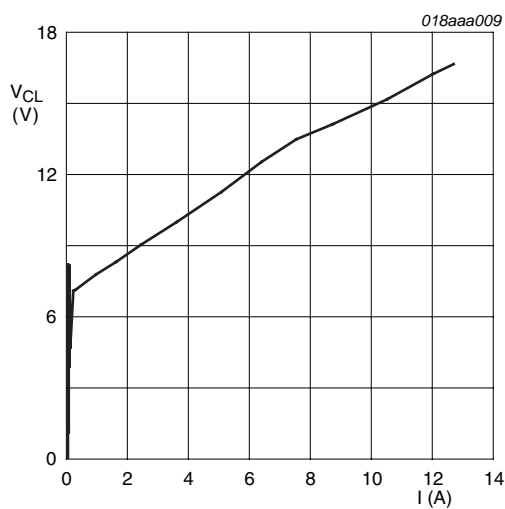

$t_p = 100 ns$ ; Transmission Line Pulse (TLP)

Fig 8. Dynamic resistance with positive clamping

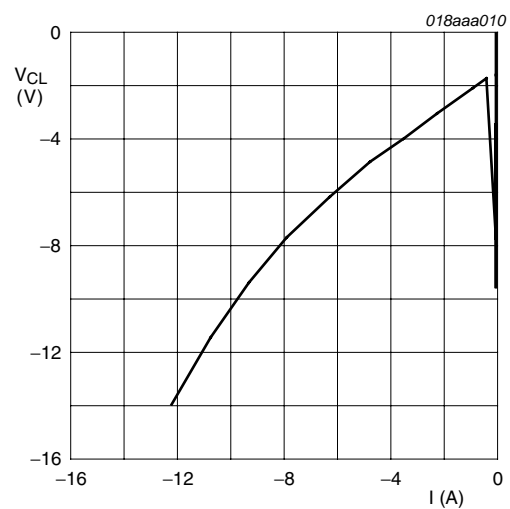

$t_p = 100 ns$ ; Transmission Line Pulse (TLP)

Fig 9. Dynamic resistance with negative clamping

7. Application information

The devices are designed to provide high-level ESD protection for high-speed serial data buses such as HDMI, DisplayPort, eSATA and LVDS data lines.

When designing the Printed-Circuit Board (PCB), careful consideration should be given to basic high-speed routing guidelines, impedance matching, and signal coupling.

Basic application diagrams for the ESD protection of an HDMI interface are shown in [Figure 10](#) and [Figure 11](#).

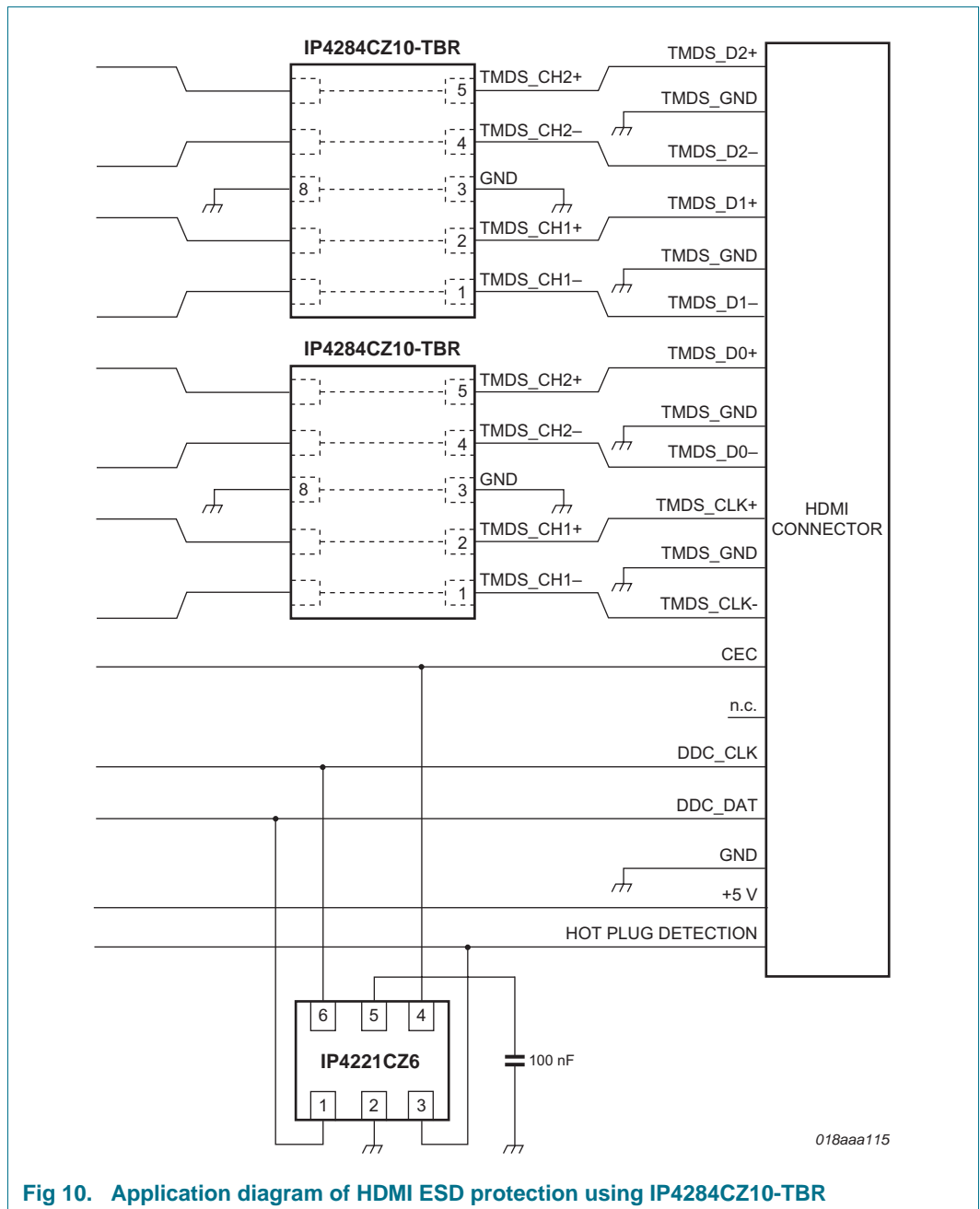

Fig 10. Application diagram of HDMI ESD protection using IP4284CZ10-TBR

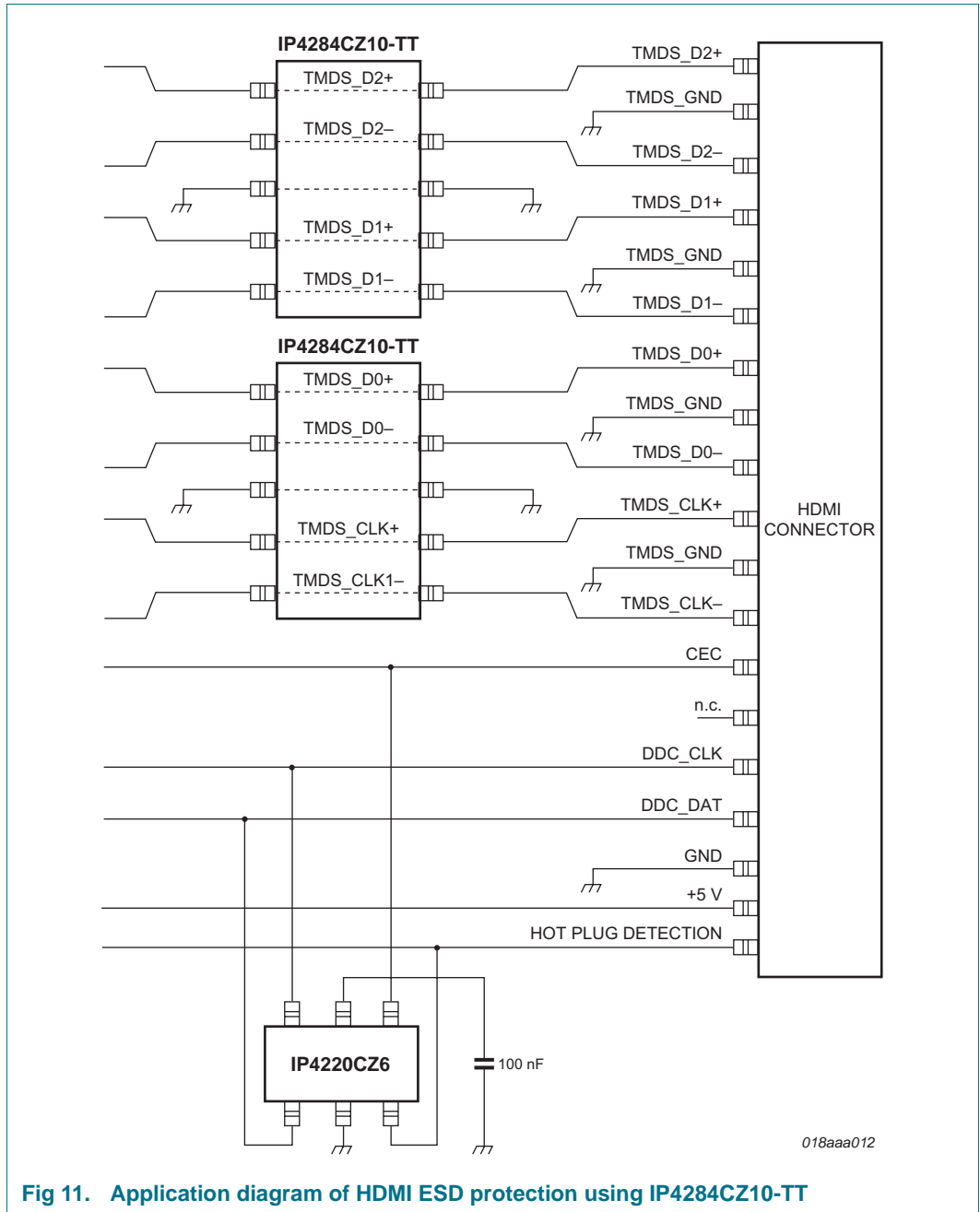

Fig 11. Application diagram of HDMI ESD protection using IP4284CZ10-TT



8. Package outline

XSON10: plastic extremely thin small outline package; no leads;  
10 terminals; body 1 x 2.5 x 0.5 mm

SOT1176-1

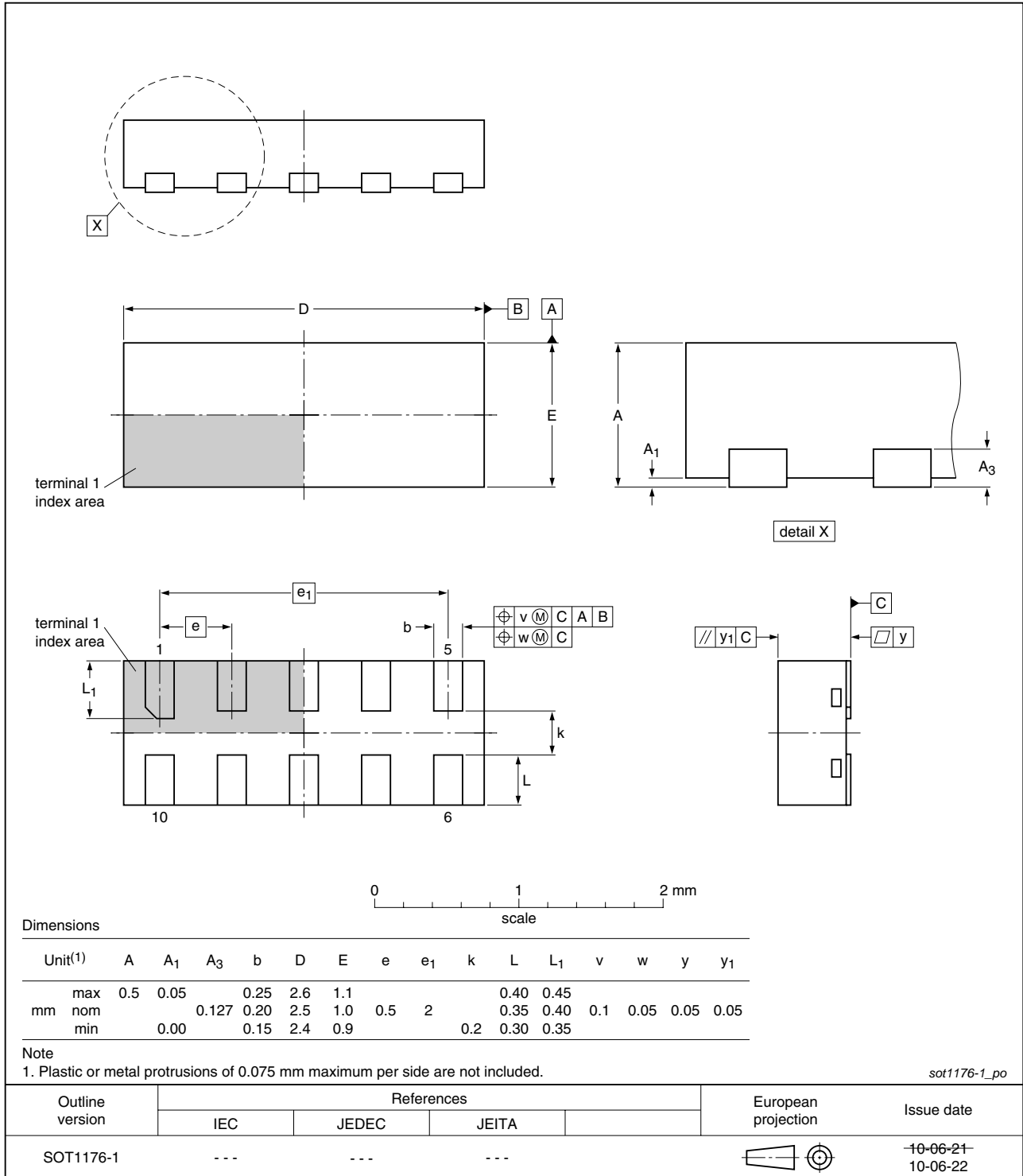

Fig 12. Package outline SOT1176-1 (XSON10)

TSSOP10: plastic thin shrink small outline package; 10 leads; body width 3 mm

SOT552-1

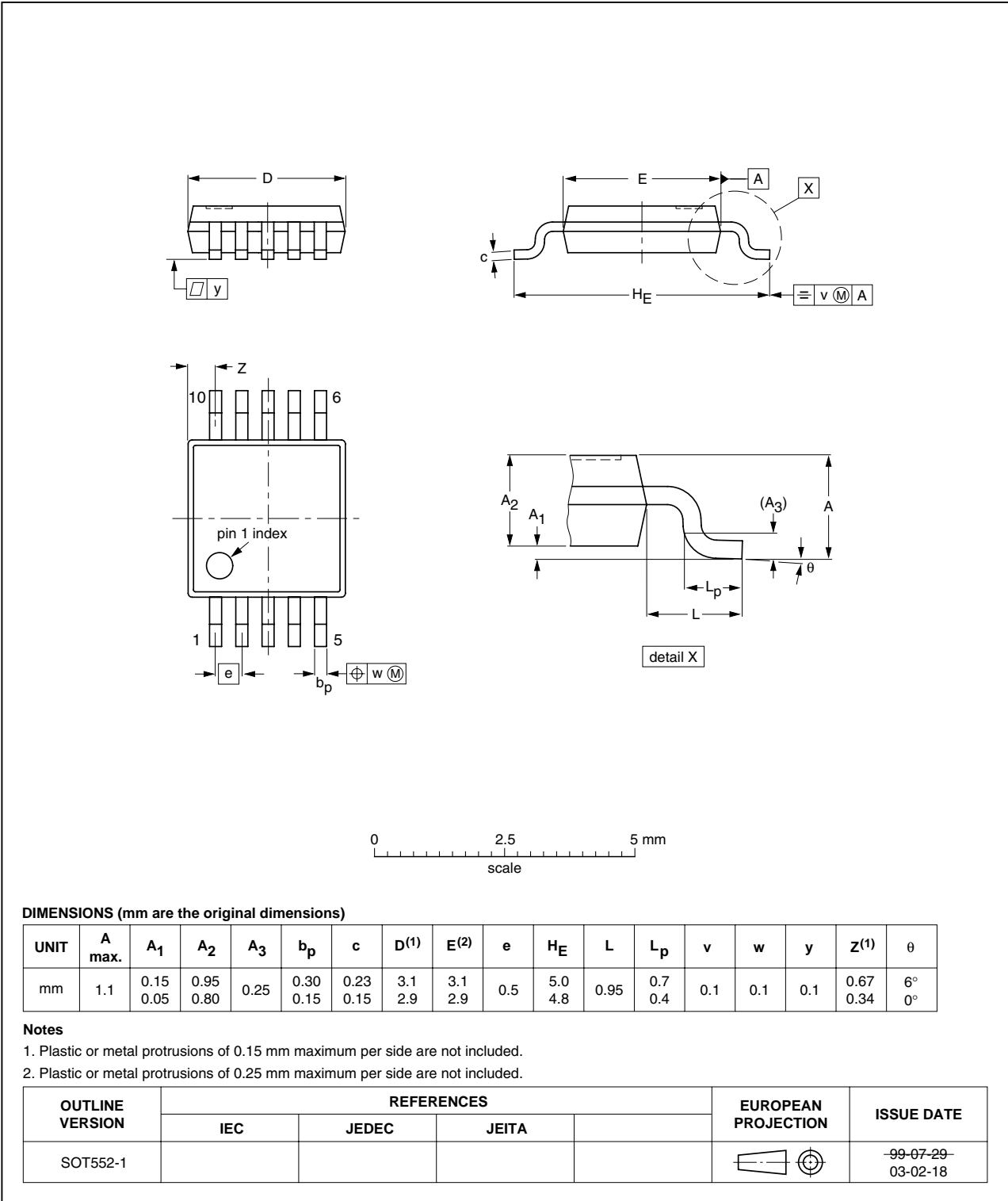
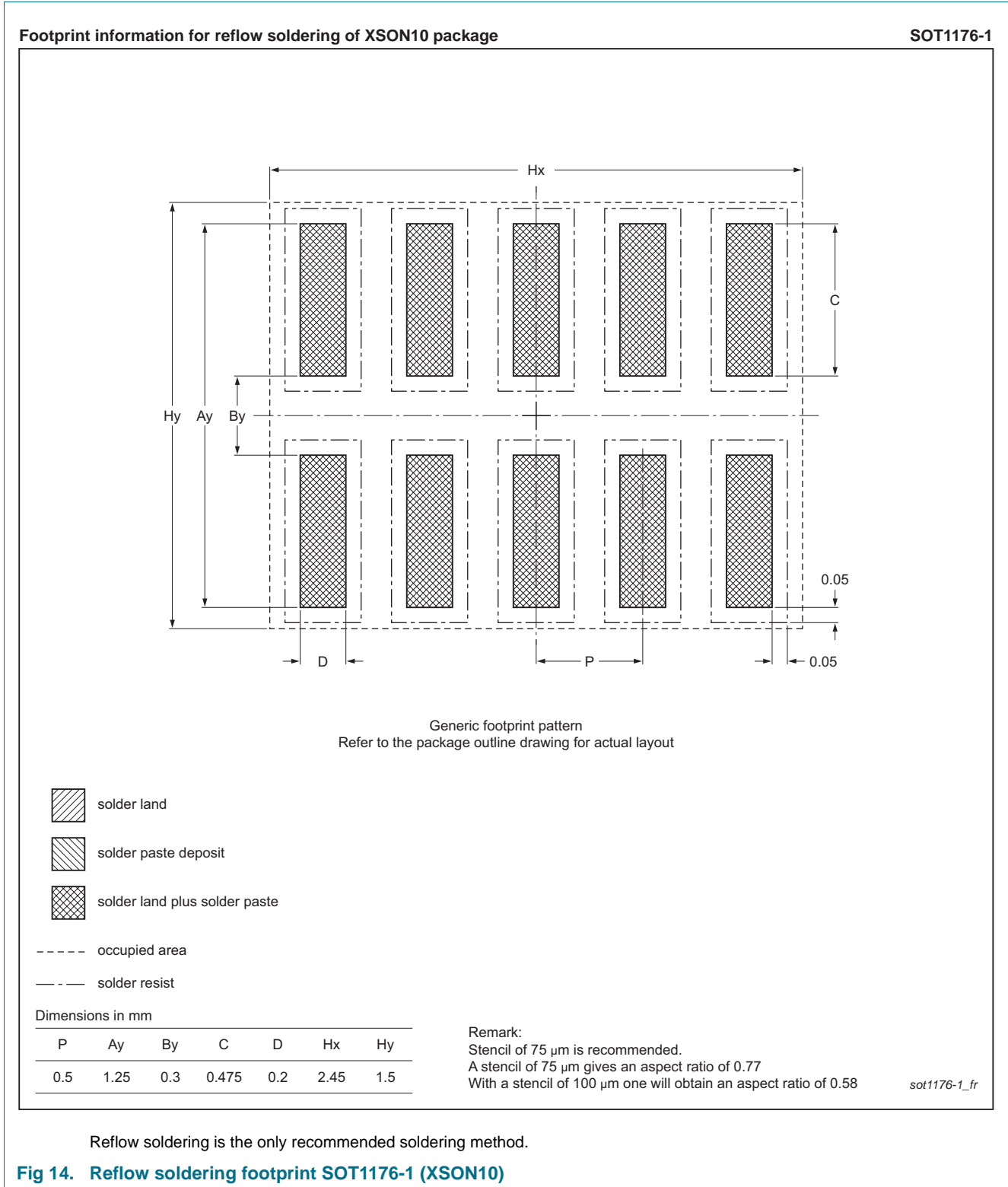

Fig 13. Package outline SOT552-1 (TSSOP10)

9. Soldering



Footprint information for reflow soldering of TSSOP10 package

SOT552-1

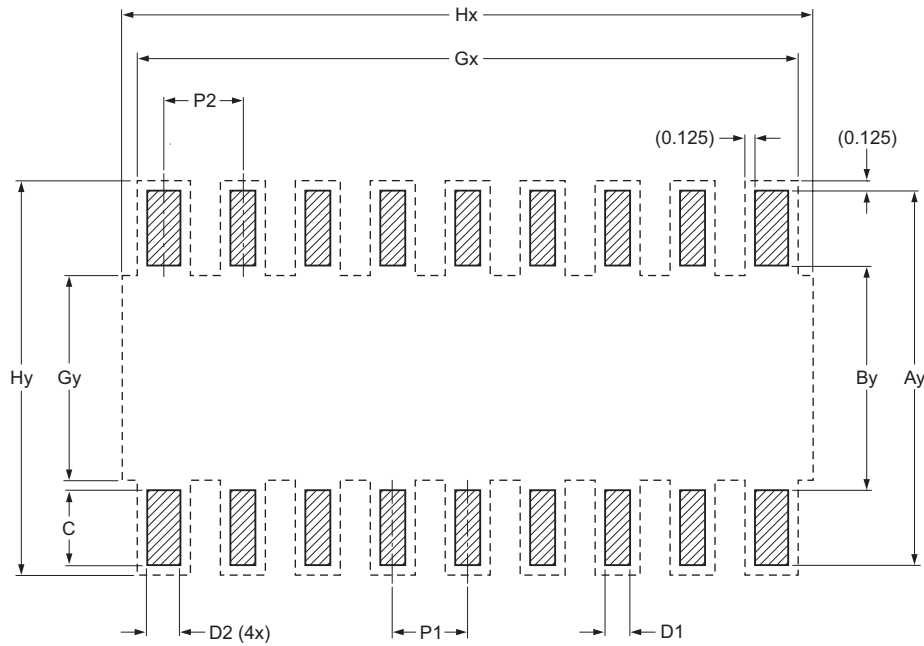

Generic footprint pattern  
Refer to the package outline drawing for actual layout

 solder land  
 - - - - occupied area

DIMENSIONS in mm

P1	P2	Ay	By	C	D1	D2	Gx	Gy	Hx	Hy
0.500	0.550	5.400	3.200	1.100	0.300	0.400	2.750	3.900	3.700	5.650

sot552-1\_fr

Reflow soldering is the only recommended soldering method.

Fig 15. Reflow soldering footprint SOT552-1 (TSSOP10)

## 10. Abbreviations

**Table 6. Abbreviations**

<b>Acronym</b>	<b>Description</b>
DVD	Digital Versatile Disc
eSATA	external Serial Advanced Technology Attachment
ESD	ElectroStatic Discharge
HBM	Human Body Model
HDMI	High-Definition Multimedia Interface
LVDS	Low Voltage Differential Signaling
NEXT	Near End Crosstalk
RoHS	Restriction of Hazardous Substances
TLP	Transmission Line Pulse
TMDS	Transition Minimized Differential Signaling
UTLP	Ultra Thin Leadless Package

## 11. Revision history

Table 7. Revision history

Document ID	Release date	Data sheet status	Change notice	Supersedes
IP4284CZ10-TBR_TT v.3	20110519	Product data sheet	-	IP4284CZ10-TB_TT v.2
Modifications:		<ul style="list-style-type: none"><li>Deleted type number IP4284CZ10-TB.</li><li>Added type number IP4284CZ10-TBR.</li><li><a href="#">Section 4 "Marking"</a>: added.</li><li><a href="#">Table 4 "Limiting values"</a>: updated <math>V_{ESD}</math> values.</li><li><a href="#">Section 9 "Soldering"</a>: added.</li><li><a href="#">Section 12 "Legal information"</a>: updated.</li></ul>		
IP4284CZ10-TB_TT v.2	20100401	Product data sheet	-	IP4284CZ10-TB_TT v.1
IP4284CZ10-TB_TT v.1	20100304	Preliminary data sheet	-	-

## 12. Legal information

### 12.1 Data sheet status

Document status <sup>[1][2]</sup>	Product status <sup>[3]</sup>	Definition
Objective [short] data sheet	Development	This document contains data from the objective specification for product development.
Preliminary [short] data sheet	Qualification	This document contains data from the preliminary specification.
Product [short] data sheet	Production	This document contains the product specification.

[1] Please consult the most recently issued document before initiating or completing a design.

[2] The term 'short data sheet' is explained in section "Definitions".

[3] The product status of device(s) described in this document may have changed since this document was published and may differ in case of multiple devices. The latest product status information is available on the Internet at URL <http://www.nxp.com>.

### 12.2 Definitions

**Draft** — The document is a draft version only. The content is still under internal review and subject to formal approval, which may result in modifications or additions. NXP Semiconductors does not give any representations or warranties as to the accuracy or completeness of information included herein and shall have no liability for the consequences of use of such information.

**Short data sheet** — A short data sheet is an extract from a full data sheet with the same product type number(s) and title. A short data sheet is intended for quick reference only and should not be relied upon to contain detailed and full information. For detailed and full information see the relevant full data sheet, which is available on request via the local NXP Semiconductors sales office. In case of any inconsistency or conflict with the short data sheet, the full data sheet shall prevail.

**Product specification** — The information and data provided in a Product data sheet shall define the specification of the product as agreed between NXP Semiconductors and its customer, unless NXP Semiconductors and customer have explicitly agreed otherwise in writing. In no event however, shall an agreement be valid in which the NXP Semiconductors product is deemed to offer functions and qualities beyond those described in the Product data sheet.

### 12.3 Disclaimers

**Limited warranty and liability** — Information in this document is believed to be accurate and reliable. However, NXP Semiconductors does not give any representations or warranties, expressed or implied, as to the accuracy or completeness of such information and shall have no liability for the consequences of use of such information.

In no event shall NXP Semiconductors be liable for any indirect, incidental, punitive, special or consequential damages (including - without limitation - lost profits, lost savings, business interruption, costs related to the removal or replacement of any products or rework charges) whether or not such damages are based on tort (including negligence), warranty, breach of contract or any other legal theory.

Notwithstanding any damages that customer might incur for any reason whatsoever, NXP Semiconductors' aggregate and cumulative liability towards customer for the products described herein shall be limited in accordance with the *Terms and conditions of commercial sale* of NXP Semiconductors.

**Right to make changes** — NXP Semiconductors reserves the right to make changes to information published in this document, including without limitation specifications and product descriptions, at any time and without notice. This document supersedes and replaces all information supplied prior to the publication hereof.

**Suitability for use** — NXP Semiconductors products are not designed, authorized or warranted to be suitable for use in life support, life-critical or safety-critical systems or equipment, nor in applications where failure or

malfunction of an NXP Semiconductors product can reasonably be expected to result in personal injury, death or severe property or environmental damage. NXP Semiconductors accepts no liability for inclusion and/or use of NXP Semiconductors products in such equipment or applications and therefore such inclusion and/or use is at the customer's own risk.

**Applications** — Applications that are described herein for any of these products are for illustrative purposes only. NXP Semiconductors makes no representation or warranty that such applications will be suitable for the specified use without further testing or modification.

Customers are responsible for the design and operation of their applications and products using NXP Semiconductors products, and NXP Semiconductors accepts no liability for any assistance with applications or customer product design. It is customer's sole responsibility to determine whether the NXP Semiconductors product is suitable and fit for the customer's applications and products planned, as well as for the planned application and use of customer's third party customer(s). Customers should provide appropriate design and operating safeguards to minimize the risks associated with their applications and products.

NXP Semiconductors does not accept any liability related to any default, damage, costs or problem which is based on any weakness or default in the customer's applications or products, or the application or use by customer's third party customer(s). Customer is responsible for doing all necessary testing for the customer's applications and products using NXP Semiconductors products in order to avoid a default of the applications and the products or of the application or use by customer's third party customer(s). NXP does not accept any liability in this respect.

**Limiting values** — Stress above one or more limiting values (as defined in the Absolute Maximum Ratings System of IEC 60134) will cause permanent damage to the device. Limiting values are stress ratings only and (proper) operation of the device at these or any other conditions above those given in the Recommended operating conditions section (if present) or the Characteristics sections of this document is not warranted. Constant or repeated exposure to limiting values will permanently and irreversibly affect the quality and reliability of the device.

**Terms and conditions of commercial sale** — NXP Semiconductors products are sold subject to the general terms and conditions of commercial sale, as published at <http://www.nxp.com/profile/terms>, unless otherwise agreed in a valid written individual agreement. In case an individual agreement is concluded only the terms and conditions of the respective agreement shall apply. NXP Semiconductors hereby expressly objects to applying the customer's general terms and conditions with regard to the purchase of NXP Semiconductors products by customer.

**No offer to sell or license** — Nothing in this document may be interpreted or construed as an offer to sell products that is open for acceptance or the grant, conveyance or implication of any license under any copyrights, patents or other industrial or intellectual property rights.

**Export control** — This document as well as the item(s) described herein may be subject to export control regulations. Export might require a prior authorization from national authorities.

**Quick reference data** — The Quick reference data is an extract of the product data given in the Limiting values and Characteristics sections of this document, and as such is not complete, exhaustive or legally binding.

**Non-automotive qualified products** — Unless this data sheet expressly states that this specific NXP Semiconductors product is automotive qualified, the product is not suitable for automotive use. It is neither qualified nor tested in accordance with automotive testing or application requirements. NXP Semiconductors accepts no liability for inclusion and/or use of non-automotive qualified products in automotive equipment or applications.

In the event that customer uses the product for design-in and use in automotive applications to automotive specifications and standards, customer (a) shall use the product without NXP Semiconductors' warranty of the

product for such automotive applications, use and specifications, and (b) whenever customer uses the product for automotive applications beyond NXP Semiconductors' specifications such use shall be solely at customer's own risk, and (c) customer fully indemnifies NXP Semiconductors for any liability, damages or failed product claims resulting from customer design and use of the product for automotive applications beyond NXP Semiconductors' standard warranty and NXP Semiconductors' product specifications.

## 12.4 Trademarks

Notice: All referenced brands, product names, service names and trademarks are the property of their respective owners.

## 13. Contact information

For more information, please visit: <http://www.nxp.com>

For sales office addresses, please send an email to: [salesaddresses@nxp.com](mailto:salesaddresses@nxp.com)



**14. Contents**

**1 Product profile . . . . . 1**

1.1 General description . . . . . 1

1.2 Features and benefits . . . . . 1

1.3 Applications . . . . . 1

**2 Pinning information . . . . . 2**

**3 Ordering information . . . . . 2**

**4 Marking . . . . . 2**

**5 Limiting values . . . . . 3**

**6 Characteristics . . . . . 3**

**7 Application information . . . . . 7**

**8 Package outline . . . . . 9**

**9 Soldering . . . . . 11**

**10 Abbreviations . . . . . 13**

**11 Revision history . . . . . 14**

**12 Legal information . . . . . 15**

12.1 Data sheet status . . . . . 15

12.2 Definitions . . . . . 15

12.3 Disclaimers . . . . . 15

12.4 Trademarks . . . . . 16

**13 Contact information . . . . . 16**

**14 Contents . . . . . 17**

Please be aware that important notices concerning this document and the product(s) described herein, have been included in section 'Legal information'.

© NXP B.V. 2011. All rights reserved.

For more information, please visit: <http://www.nxp.com>  
 For sales office addresses, please send an email to: [salesaddresses@nxp.com](mailto:salesaddresses@nxp.com)

Date of release: 19 May 2011  
 Document identifier: IP4284CZ10-TBR\_TT