

SA58631

3 W BTL audio amplifier

Rev. 02 — 12 October 2007

Product data sheet

1. General description

The SA58631 is a one channel audio amplifier in an HVSON8 package. It provides power output of 3 W with an 8 Ω load at 9 V supply. The internal circuit is comprised of a BTL (Bridge Tied Load) amplifier with a complementary PNP-NPN output stage and standby/mute logic. The SA58631 is housed in an 8-pin HVSON package which has an exposed die attach paddle enabling reduced thermal resistance and increased power dissipation.

2. Features

- Low junction-to-ambient thermal resistance using exposed die attach paddle
- Gain can be fixed with external resistors from 6 dB to 30 dB
- Standby mode controlled by CMOS-compatible levels
- Low standby current < 10 μ A
- No switch-on/switch-off plops
- High power supply ripple rejection: 50 dB minimum
- ElectroStatic Discharge (ESD) protection
- Output short circuit to ground protection
- Thermal shutdown protection

3. Applications

- Professional and amateur mobile radio
- Portable consumer products: toys and games
- Personal computer remote speakers

4. Quick reference data

Table 1. Quick reference data

$V_{CC} = 5\text{ V}$; $T_{amb} = 25\text{ }^{\circ}\text{C}$; $R_L = 8\ \Omega$; $f = 1\text{ kHz}$; $V_{MODE} = 0\text{ V}$; measured in test circuit [Figure 3](#); unless otherwise specified.

Symbol	Parameter	Conditions	Min	Typ	Max	Unit
V_{CC}	supply voltage	operating	2.2	9	18	V
I_q	quiescent current	$R_L = \infty\ \Omega$	[1] -	8	12	mA
I_{stb}	standby current	$V_{MODE} = V_{CC}$	-	-	10	μA
P_o	output power	THD+N = 10 %	1	1.2	-	W
		THD+N = 0.5 %	0.6	0.9	-	W
		THD+N = 10 %; $V_{CC} = 9\text{ V}$	-	3.0	-	W
THD+N	total harmonic distortion-plus-noise	$P_o = 0.5\text{ W}$	-	0.15	0.3	%
PSRR	power supply rejection ratio		[2] 50	-	-	dB
			[3] 40	-	-	dB

- [1] With a load connected at the outputs the quiescent current will increase, the maximum of this increase being equal to the DC output offset voltage divided by R_L .
- [2] Supply voltage ripple rejection is measured at the output with a source impedance of $R_s = 0\ \Omega$ at the input. The ripple voltage is a sine wave with a frequency of 1 kHz and an amplitude of 100 mV (RMS), which is applied to the positive supply rail.
- [3] Supply voltage ripple rejection is measured at the output, with a source impedance of $R_s = 0\ \Omega$ at the input. The ripple voltage is a sine wave with a frequency between 100 Hz and 20 kHz and an amplitude of 100 mV (RMS), which is applied to the positive supply rail.

5. Ordering information

Table 2. Ordering information

Type number	Package		Version
	Name	Description	
SA58631TK	HVSON8	plastic thermal enhanced very thin small outline package; no leads; 8 terminals; body 4 x 4 x 0.85 mm	SOT909-1

6. Block diagram

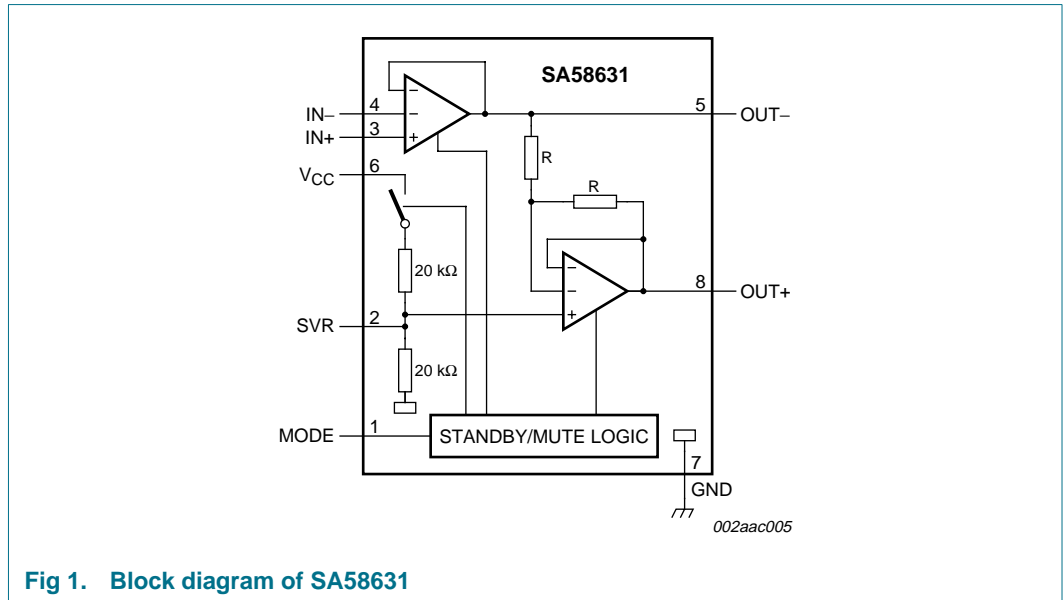

Fig 1. Block diagram of SA58631

7. Pinning information

7.1 Pinning

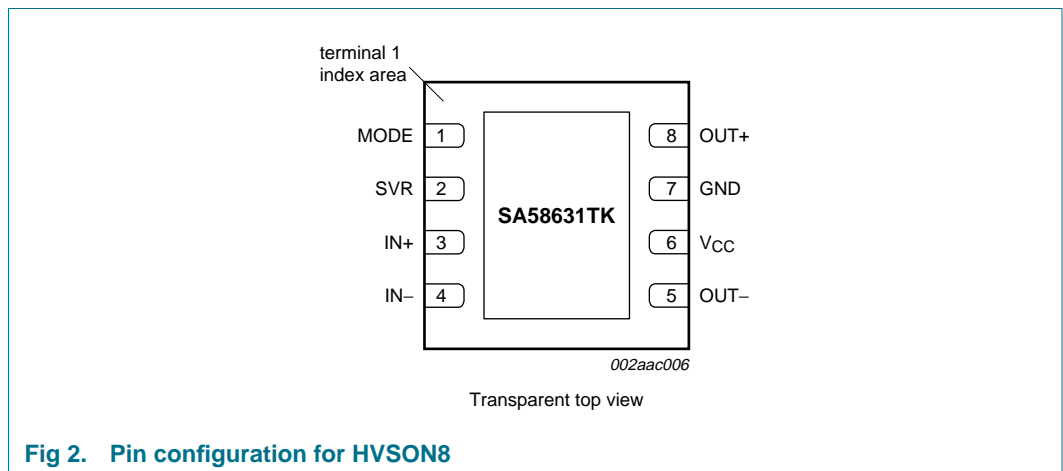

Fig 2. Pin configuration for HVSON8

7.2 Pin description

Table 3. Pin description

Symbol	Pin	Description
MODE	1	operating mode select (standby, mute, operating)
SVR	2	half supply voltage, decoupling ripple rejection
IN+	3	positive input
IN-	4	negative input
OUT-	5	negative output terminal
V _{CC}	6	supply voltage
GND	7	ground
OUT+	8	positive output terminal

8. Functional description

The SA58631 is a single-channel BTL audio amplifier capable of delivering 3 W output power to an 8 Ω load at THD+N = 10 % using a 9 V power supply. Using the MODE pin, the device can be switched to standby and mute condition. The device is protected by an internal thermal shutdown protection mechanism. The gain can be set within a range of 6 dB to 30 dB by external feedback resistors.

8.1 Power amplifier

The power amplifier is a Bridge Tied Load (BTL) amplifier with a complementary PNP-NPN output stage. The voltage loss on the positive supply line is the saturation voltage of a PNP power transistor, on the negative side the saturation voltage of an NPN power transistor. The total voltage loss is < 1 V. With a supply voltage of 9 V and an 8 Ω loudspeaker, an output power of 3 W can be delivered to the load.

8.2 Mode select pin (MODE)

The device is in Standby mode (with a very low current consumption) if the voltage at the MODE pin is greater than $V_{CC} - 0.5$ V, or if this pin is floating. At a MODE voltage in the range between 1.5 V and $V_{CC} - 1.5$ V the amplifier is in a mute condition. The mute condition is useful to suppress plop noise at the output, caused by charging of the input capacitor.

9. Limiting values

Table 4. Limiting values

In accordance with the Absolute Maximum Rating System (IEC 60134).

Symbol	Parameter	Conditions	Min	Max	Unit
V_{CC}	supply voltage	operating	-0.3	+18	V
V_I	input voltage		-0.3	$V_{CC} + 0.3$	V
I_{ORM}	repetitive peak output current		-	1	A
T_{stg}	storage temperature	non-operating	-55	+150	°C
T_{amb}	ambient temperature	operating	-40	+85	°C
$V_{P(sc)}$	short-circuit supply voltage		[1] -	10	V
P_{tot}	total power dissipation	HVSON8	-	2.3	W

[1] AC and DC short-circuit safe voltage.

10. Thermal characteristics

Table 5. Thermal characteristics

Symbol	Parameter	Conditions	Typ	Unit
$R_{th(j-a)}$	thermal resistance from junction to ambient	free air	80	K/W
		9.7 cm ² (1.5 in ²) heat spreader	[1] 32	K/W
		32 cm ² (5 in ²) heat spreader	[1] 28	K/W
$R_{th(j-sp)}$	thermal resistance from junction to solder point		5	K/W

[1] Thermal resistance is 28 K/W with DAP soldered to 32 cm² (5 in²), 35 μm copper (1 ounce copper) heat spreader.

11. Static characteristics

Table 6. Static characteristics

$V_{CC} = 5\text{ V}$; $T_{amb} = 25\text{ }^{\circ}\text{C}$; $R_L = 8\ \Omega$; $V_{MODE} = 0\text{ V}$; measured in test circuit [Figure 3](#); unless otherwise specified.

Symbol	Parameter	Conditions	Min	Typ	Max	Unit
V_{CC}	supply voltage	operating	2.2	9	18	V
I_q	quiescent current	$R_L = \infty\ \Omega$	[1] -	8	12	mA
I_{stb}	standby current	$V_{MODE} = V_{CC}$	-	-	10	μA
V_O	output voltage		[2] -	2.2	-	V
$\Delta V_{O(\text{offset})}$	differential output voltage offset		-	-	50	mV
$I_{B(\text{IN+})}$	input bias current on pin IN+		-	-	500	nA
$I_{B(\text{IN-})}$	input bias current on pin IN-		-	-	500	nA
V_{MODE}	voltage on pin MODE	operating	0	-	0.5	V
		mute	1.5	-	$V_{CC} - 1.5$	V
		standby	$V_{CC} - 0.5$	-	V_{CC}	V
I_{MODE}	current on pin MODE	$0\text{ V} < V_{MODE} < V_{CC}$	-	-	20	μA

- [1] With a load connected at the outputs the quiescent current will increase, the maximum of this increase being equal to the DC output offset voltage divided by R_L .
- [2] The DC output voltage with respect to ground is approximately $0.5 \times V_{CC}$.

12. Dynamic characteristics

Table 7. Dynamic characteristics

$V_{CC} = 5\text{ V}$; $T_{amb} = 25\text{ }^{\circ}\text{C}$; $R_L = 8\ \Omega$; $f = 1\text{ kHz}$; $V_{MODE} = 0\text{ V}$; measured in test circuit [Figure 3](#); unless otherwise specified.

Symbol	Parameter	Conditions	Min	Typ	Max	Unit
P_o	output power	THD+N = 10 %	1	1.2	-	W
		THD+N = 0.5 %	0.6	0.9	-	W
		THD+N = 10 %; $V_{CC} = 9\text{ V}$	-	3.0	-	W
THD+N	total harmonic distortion-plus-noise	$P_o = 0.5\text{ W}$	-	0.15	0.3	%
$G_{V(\text{cl})}$	closed-loop voltage gain		[1] 6	-	30	dB
ΔZ_i	differential input impedance		-	100	-	k Ω
$V_{n(o)}$	noise output voltage		[2] -	-	100	μV
PSRR	power supply rejection ratio		[3] 50	-	-	dB
			[4] 40	-	-	dB
V_o	output voltage	mute condition	[5] -	-	200	μV

- [1] Gain of the amplifier is $2 \times (R_2 / R_1)$ in test circuit of [Figure 3](#).
- [2] The noise output voltage is measured at the output in a frequency range from 20 Hz to 20 kHz (unweighted), with a source impedance of $R_s = 0\ \Omega$ at the input.
- [3] Supply voltage ripple rejection is measured at the output with a source impedance of $R_s = 0\ \Omega$ at the input. The ripple voltage is a sine wave with a frequency of 1 kHz and an amplitude of 100 mV (RMS), which is applied to the positive supply rail.
- [4] Supply voltage ripple rejection is measured at the output, with a source impedance of $R_s = 0\ \Omega$ at the input. The ripple voltage is a sine wave with a frequency between 100 Hz and 20 kHz and an amplitude of 100 mV (RMS), which is applied to the positive supply rail.
- [5] Output voltage in mute position is measured with an input voltage of 1 V (RMS) in a bandwidth of 20 kHz, which includes noise.

13. Application information

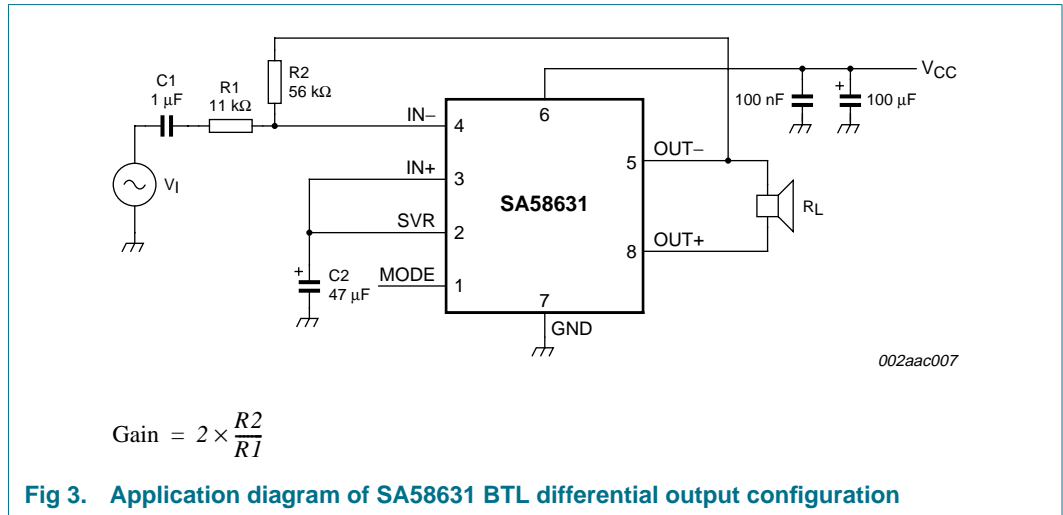

14. Test information

14.1 Test conditions

The junction to ambient thermal resistance, $R_{th(j-a)} = 27.7$ K/W for the HVSON8 package when the exposed die attach paddle is soldered to 32 cm² (5 in²) area of 35 μm (1 ounce) copper heat spreader on the demo PCB. The maximum sine wave power dissipation for $T_{amb} = 25$ °C is:

$$\frac{150 - 25}{27.7} = 4.5 \text{ W}$$

Thus, for $T_{amb} = +85$ °C the maximum total power dissipation is:

$$\frac{150 - 85}{27.7} = 2.35 \text{ W}$$

The power dissipation versus ambient temperature curve ([Figure 5](#)) shows the power derating profiles with ambient temperature for three sizes of heat spreaders. For a more modest heat spreader using 9.7 cm² (1.5 in²) area on the top side of the PCB, the $R_{th(j-a)}$ is 31.25 K/W. When the package is not soldered to a heat spreader, the $R_{th(j-a)}$ increases to 83.3 K/W.

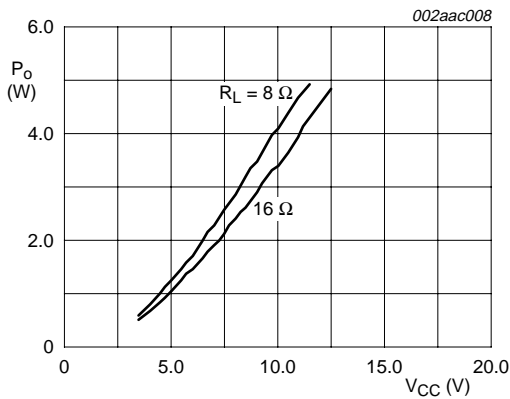
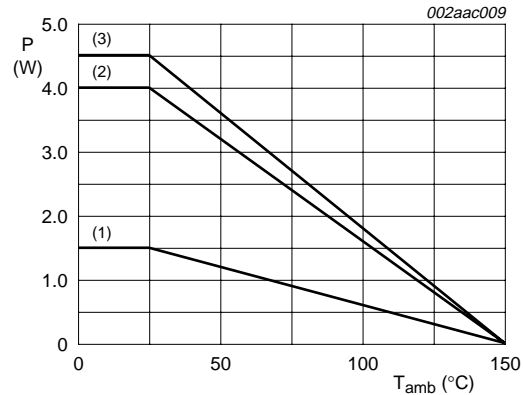

Fig 4. Output power versus supply voltage @ THD+N = 10 %; 32 cm² (5 in²) heat spreader



(1) No heat spreader.
 (2) Top only heat spreader (9.7 cm² (1.5 in²), 35 μm (1 ounce) copper).
 (3) Both top and bottom heat spreader (approximately 32 cm² (5 in²), 35 μm (1 ounce) copper).
 Fig 5. Power dissipation versus ambient temperature

14.2 BTL application

$T_{amb} = 25\text{ °C}$, $V_{CC} = 9\text{ V}$, $f = 1\text{ kHz}$, $R_L = 8\text{ Ω}$, $G_v = 20\text{ dB}$, audio band-pass 20 Hz to 20 kHz. The BTL diagram is shown in [Figure 3](#).

The quiescent current has been measured without any load impedance. The total harmonic distortion + noise (THD+N) as a function of frequency was measured with a low-pass filter of 80 kHz. The value of capacitor C2 influences the behavior of PSRR at low frequencies; increasing the value of C2 increases the performance of PSRR. [Figure 6](#) shows three areas: operating, mute and standby. It shows that the DC switching levels of the mute and standby respectively depends on the supply voltage level.

The following characterization curves show the room temperature performance for SA58631 using the demo PCB shown in [Figure 21](#). The 8 curves for power dissipation versus output power ([Figure 10](#) through [Figure 17](#)) as a function of supply voltage, heat spreader area, load resistance and voltage gain show that there is very little difference in performance with voltage gain; however, there are significant differences with supply voltage and load resistance.

The curves for THD+N versus output power ([Figure 18](#)) show that the SA58631 yields the best power output using an 8 Ω load at 9 V supply. Under these conditions the part delivers typically 3 W output power for THD+N = 10 %.

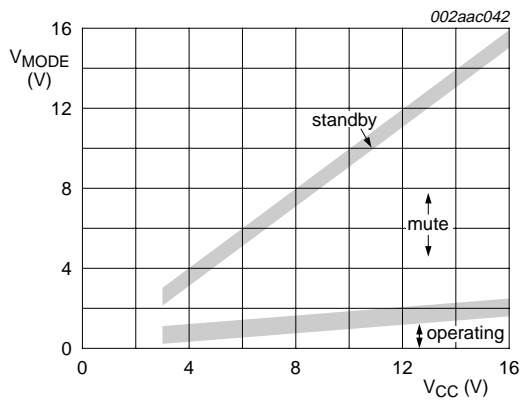

Fig 6. V_{MODE} versus V_{CC}

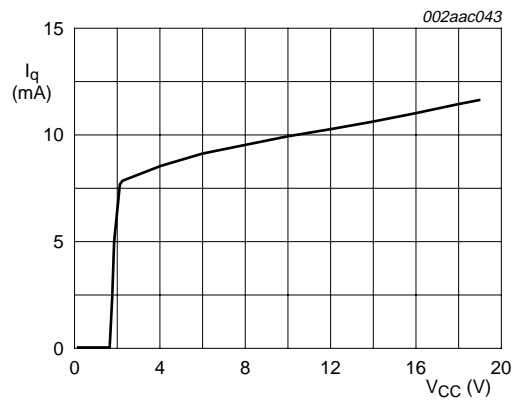
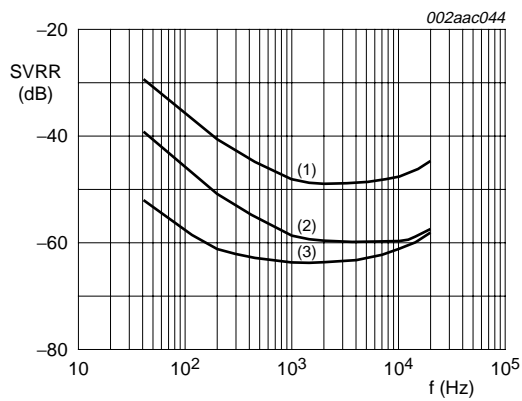

Fig 7. I_q versus V_{CC}



$V_{CC} = 5$ V; $R_L = 8 \Omega$; $R_s = 0 \Omega$; $V_i = 100$ mV.

- (1) $G_v = 30$ dB
- (2) $G_v = 20$ dB
- (3) $G_v = 6$ dB

Fig 8. SVRR versus frequency

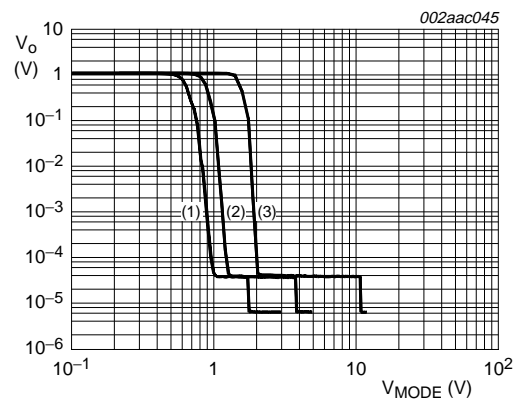

Band-pass = 22 Hz to 22 kHz.

- (1) $V_{CC} = 3$ V
- (2) $V_{CC} = 5$ V
- (3) $V_{CC} = 12$ V

Fig 9. V_o versus V_{MODE}

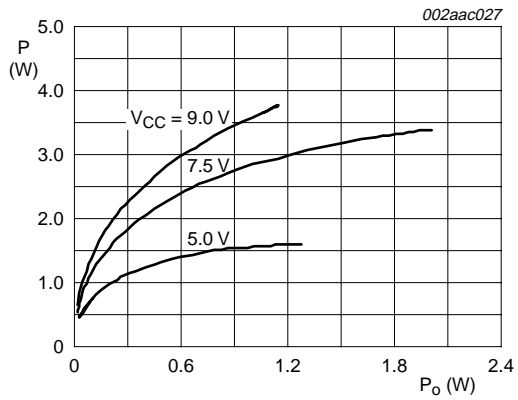

Fig 10. Power dissipation versus output power; $R_L = 4.0 \Omega$; $G_v = 10$ dB; 9.7 cm^2 (1.5 in^2) heat spreader

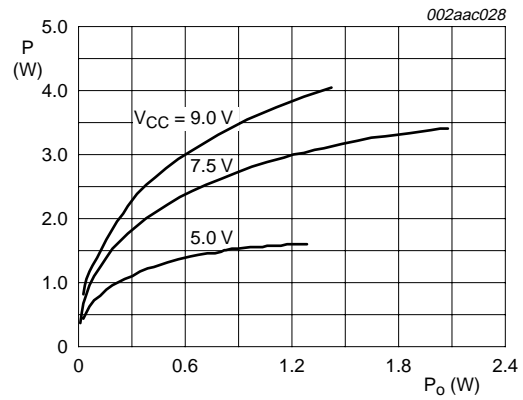

Fig 11. Power dissipation versus output power; $R_L = 4.0 \Omega$; $G_v = 20$ dB; 9.7 cm^2 (1.5 in^2) heat spreader

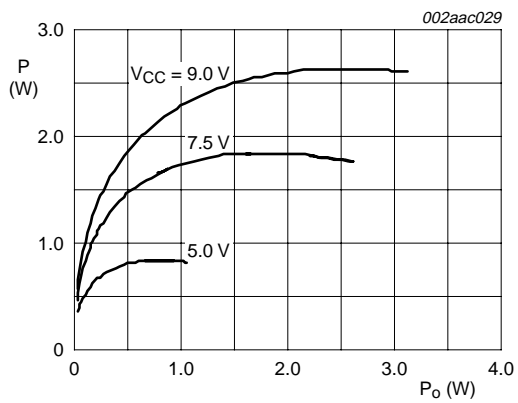

Fig 12. Power dissipation versus output power; $R_L = 8.0 \Omega$; $G_v = 10$ dB; 9.7 cm^2 (1.5 in^2) heat spreader

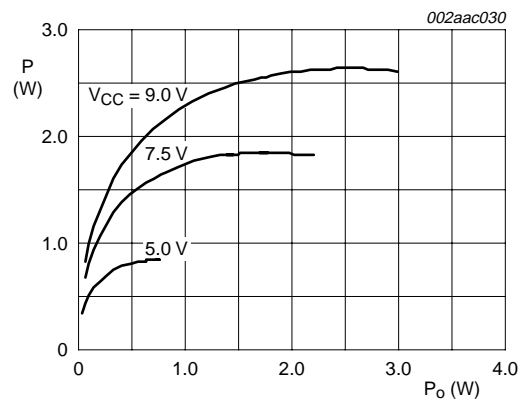

Fig 13. Power dissipation versus output power; $R_L = 8.0 \Omega$; $G_v = 20$ dB; 9.7 cm^2 (1.5 in^2) heat spreader

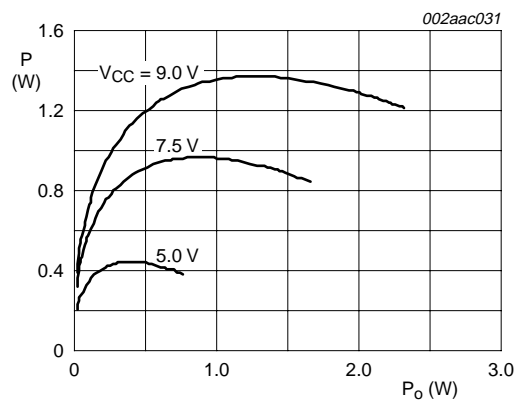

Fig 14. Power dissipation versus output power; $R_L = 16 \Omega$; $G_v = 10$ dB; 9.7 cm^2 (1.5 in^2) heat spreader

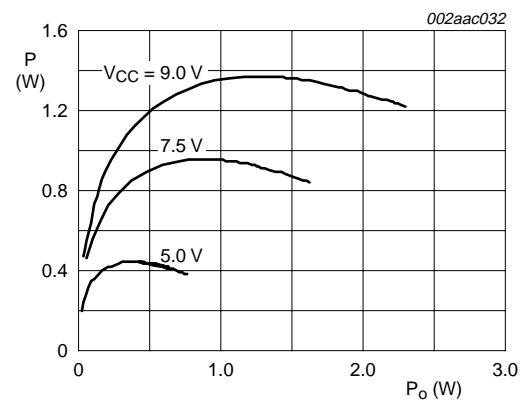

Fig 15. Power dissipation versus output power; $R_L = 16 \Omega$; $G_v = 20$ dB; 9.7 cm^2 (1.5 in^2) heat spreader

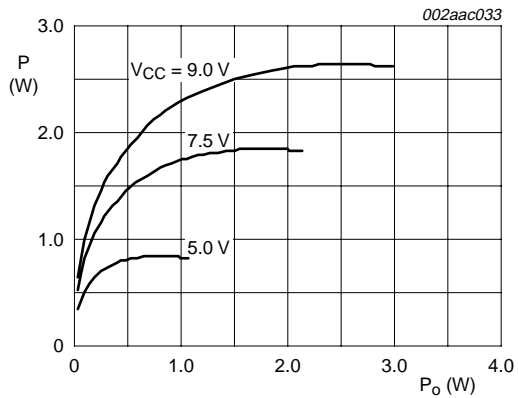

Fig 16. Power dissipation versus output power; $R_L = 8.0 \Omega$; $G_V = 20 \text{ dB}$; 32 cm^2 (5 in^2) heat spreader

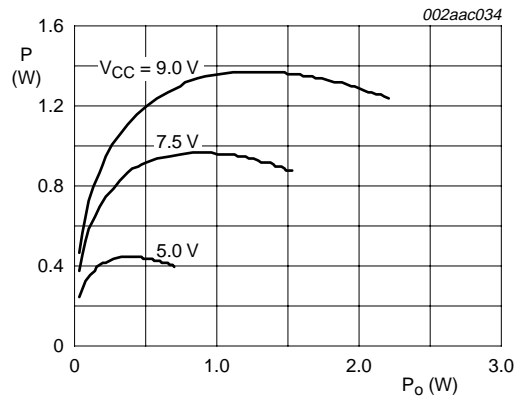
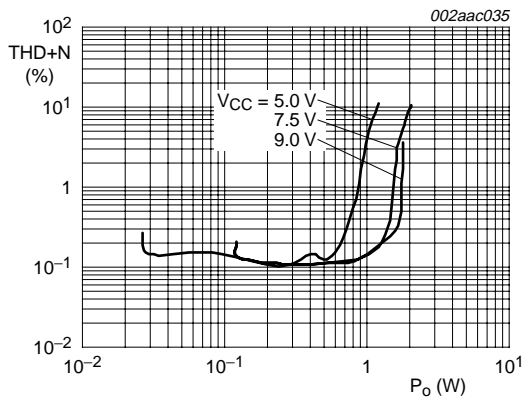
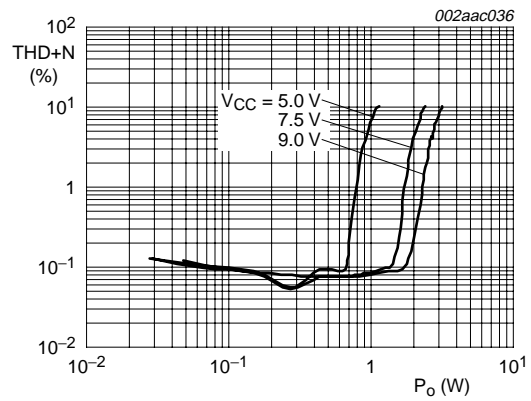

Fig 17. Power dissipation versus output power; $R_L = 16 \Omega$; $G_V = 20 \text{ dB}$; 32 cm^2 (5 in^2) heat spreader



a. $f = 1 \text{ kHz}$; $R_L = 4 \Omega$



b. $f = 1 \text{ kHz}$; $R_L = 8 \Omega$

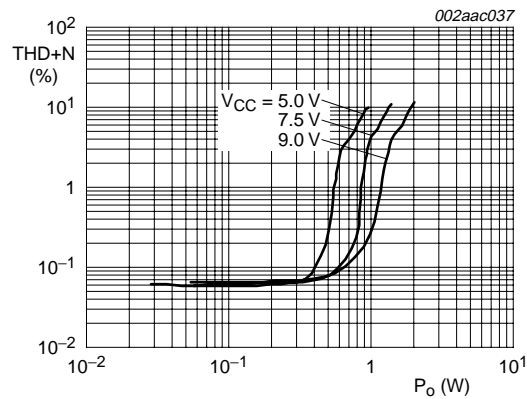

c. $f = 1 \text{ kHz}$; $R_L = 16 \Omega$

Fig 18. THD+N versus output power

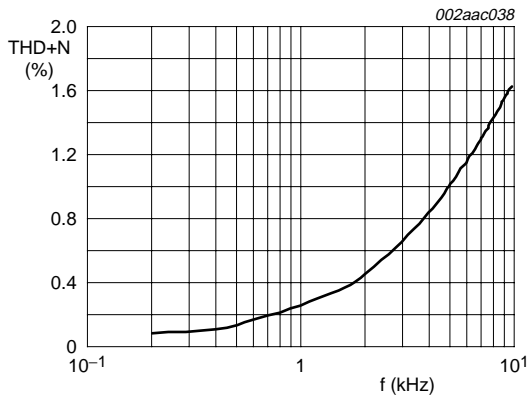

a. $R_L = 4 \Omega$

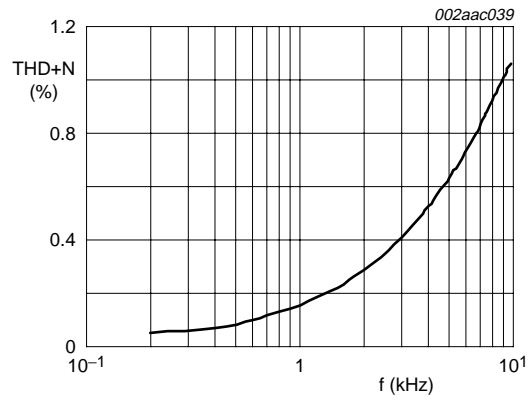

b. $R_L = 8 \Omega$

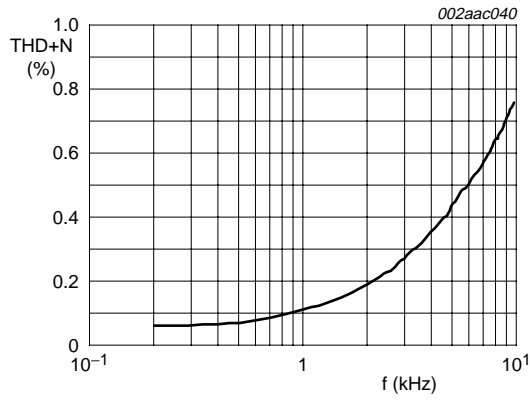

c. $R_L = 16 \Omega$

Fig 19. THD+N versus frequency

14.3 Single-ended application

$T_{amb} = 25\text{ }^{\circ}\text{C}$; $V_{CC} = 7.5\text{ V}$; $f = 1\text{ kHz}$; $R_L = 8\text{ }\Omega$; $G_v = 20\text{ dB}$; audio band-pass 20 Hz to 20 kHz.

The Single-Ended (SE) application diagram is shown in [Figure 20](#).

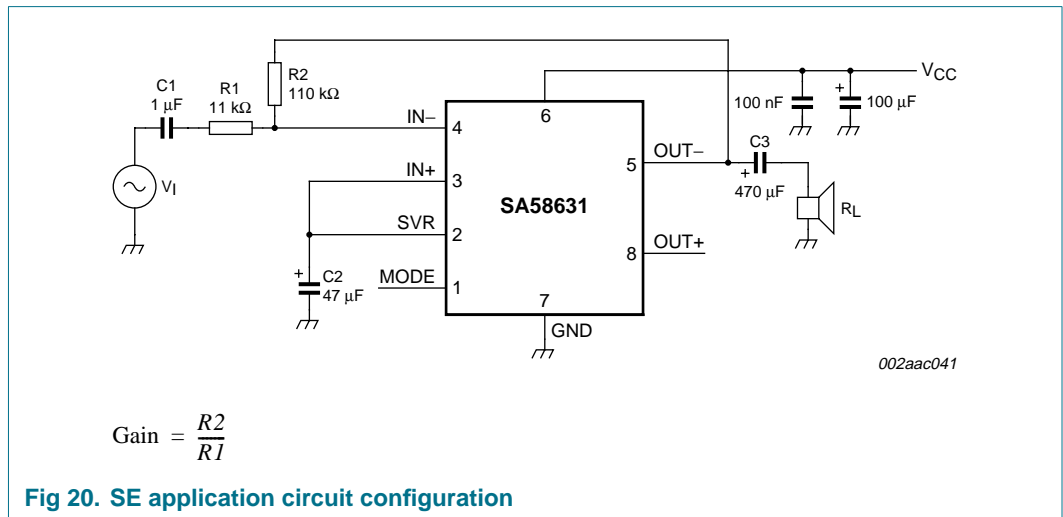

The capacitor value of C3 in combination with the load impedance determines the low frequency behavior. The total harmonic distortion + noise as a function of frequency was measured with a low-pass filter of 80 kHz. The value of the capacitor C2 influences the behavior of the PSRR at low frequencies; increasing the value of C2 increases the performance of PSRR.

14.4 General remarks

The frequency characteristics can be adapted by connecting a small capacitor across the feedback resistor. To improve the immunity of HF radiation in radio circuit applications, a small capacitor can be connected in parallel with the feedback resistor (56 kΩ); this creates a low-pass filter.

14.5 SA58631TK PCB demo

The application demo board may be used for evaluation in either BTL or SE configuration as shown in the schematics in [Figure 3](#) and [Figure 20](#). The demo PCB is laid out for the 32 cm² (5 in²) heat spreader (total of top and bottom heat spreader area).

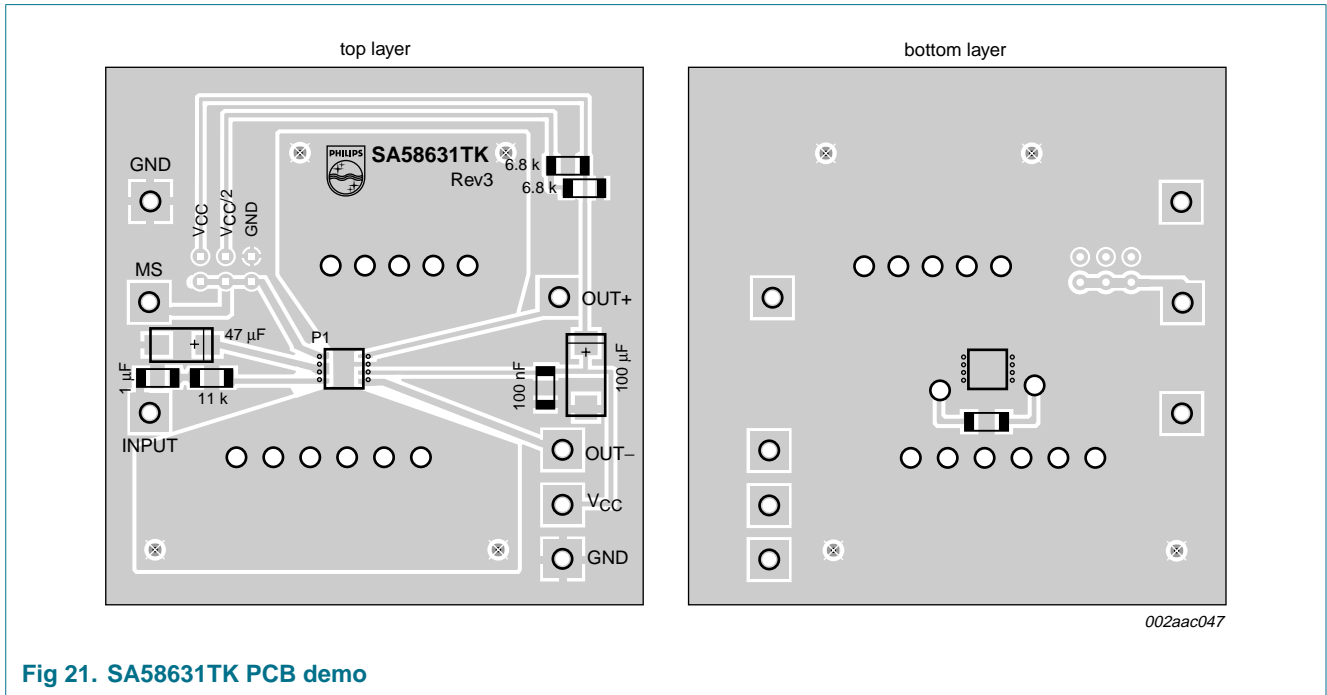

Fig 21. SA58631TK PCB demo

15. Package outline

HVSON8: plastic thermal enhanced very thin small outline package; no leads; 8 terminals; body 4 x 4 x 0.85 mm

SOT909-1

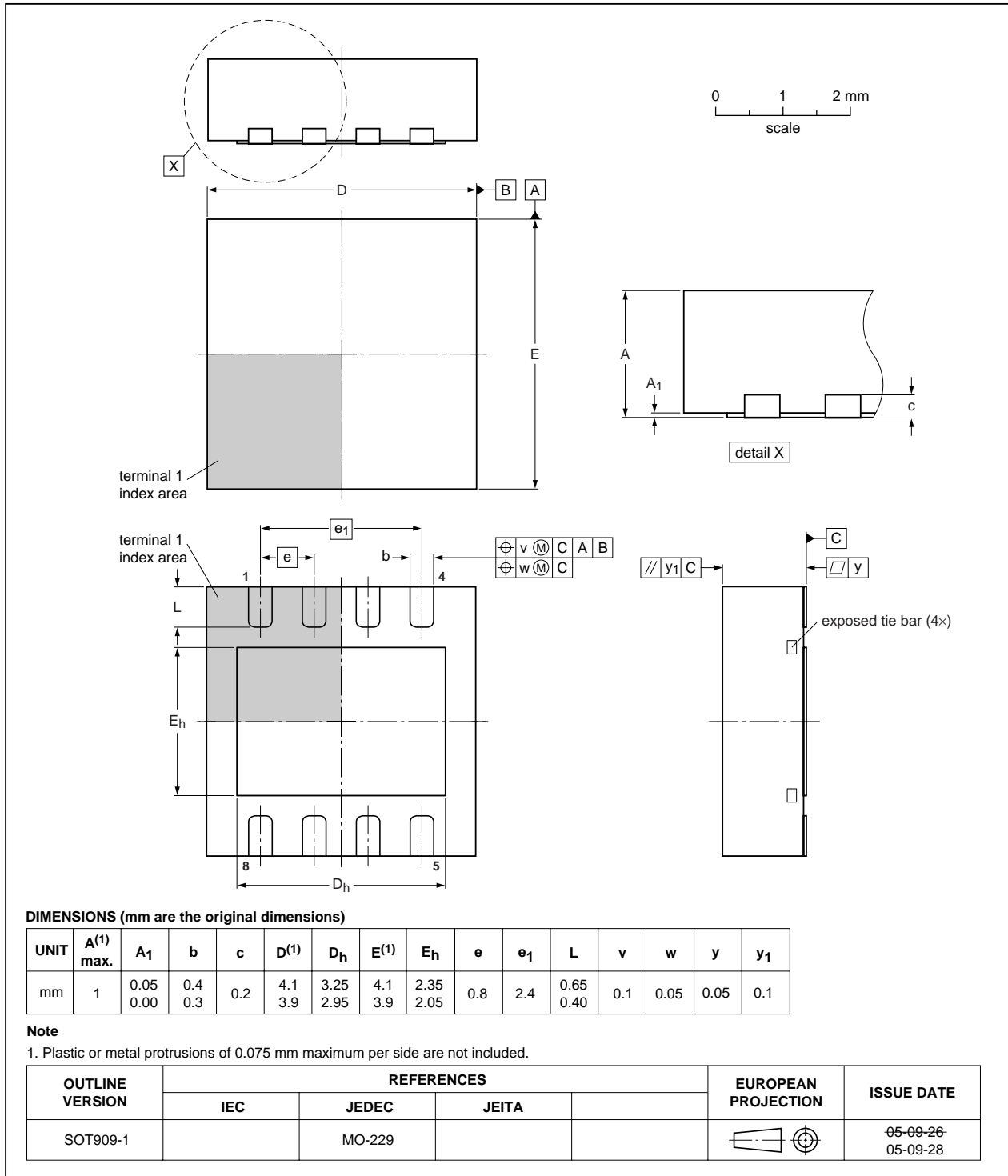

Fig 22. Package outline SOT909-1 (HVSON8)

16. Soldering

This text provides a very brief insight into a complex technology. A more in-depth account of soldering ICs can be found in Application Note *AN10365 "Surface mount reflow soldering description"*.

16.1 Introduction to soldering

Soldering is one of the most common methods through which packages are attached to Printed Circuit Boards (PCBs), to form electrical circuits. The soldered joint provides both the mechanical and the electrical connection. There is no single soldering method that is ideal for all IC packages. Wave soldering is often preferred when through-hole and Surface Mount Devices (SMDs) are mixed on one printed wiring board; however, it is not suitable for fine pitch SMDs. Reflow soldering is ideal for the small pitches and high densities that come with increased miniaturization.

16.2 Wave and reflow soldering

Wave soldering is a joining technology in which the joints are made by solder coming from a standing wave of liquid solder. The wave soldering process is suitable for the following:

- Through-hole components
- Leaded or leadless SMDs, which are glued to the surface of the printed circuit board

Not all SMDs can be wave soldered. Packages with solder balls, and some leadless packages which have solder lands underneath the body, cannot be wave soldered. Also, leaded SMDs with leads having a pitch smaller than ~0.6 mm cannot be wave soldered, due to an increased probability of bridging.

The reflow soldering process involves applying solder paste to a board, followed by component placement and exposure to a temperature profile. Leaded packages, packages with solder balls, and leadless packages are all reflow solderable.

Key characteristics in both wave and reflow soldering are:

- Board specifications, including the board finish, solder masks and vias
- Package footprints, including solder thieves and orientation
- The moisture sensitivity level of the packages
- Package placement
- Inspection and repair
- Lead-free soldering versus PbSn soldering

16.3 Wave soldering

Key characteristics in wave soldering are:

- Process issues, such as application of adhesive and flux, clinching of leads, board transport, the solder wave parameters, and the time during which components are exposed to the wave
- Solder bath specifications, including temperature and impurities

16.4 Reflow soldering

Key characteristics in reflow soldering are:

- Lead-free versus SnPb soldering; note that a lead-free reflow process usually leads to higher minimum peak temperatures (see [Figure 23](#)) than a PbSn process, thus reducing the process window
- Solder paste printing issues including smearing, release, and adjusting the process window for a mix of large and small components on one board
- Reflow temperature profile; this profile includes preheat, reflow (in which the board is heated to the peak temperature) and cooling down. It is imperative that the peak temperature is high enough for the solder to make reliable solder joints (a solder paste characteristic). In addition, the peak temperature must be low enough that the packages and/or boards are not damaged. The peak temperature of the package depends on package thickness and volume and is classified in accordance with [Table 8](#) and [9](#)

Table 8. SnPb eutectic process (from J-STD-020C)

Package thickness (mm)	Package reflow temperature (°C)	
	Volume (mm ³)	
	< 350	≥ 350
< 2.5	235	220
≥ 2.5	220	220

Table 9. Lead-free process (from J-STD-020C)

Package thickness (mm)	Package reflow temperature (°C)		
	Volume (mm ³)		
	< 350	350 to 2000	> 2000
< 1.6	260	260	260
1.6 to 2.5	260	250	245
> 2.5	250	245	245

Moisture sensitivity precautions, as indicated on the packing, must be respected at all times.

Studies have shown that small packages reach higher temperatures during reflow soldering, see [Figure 23](#).

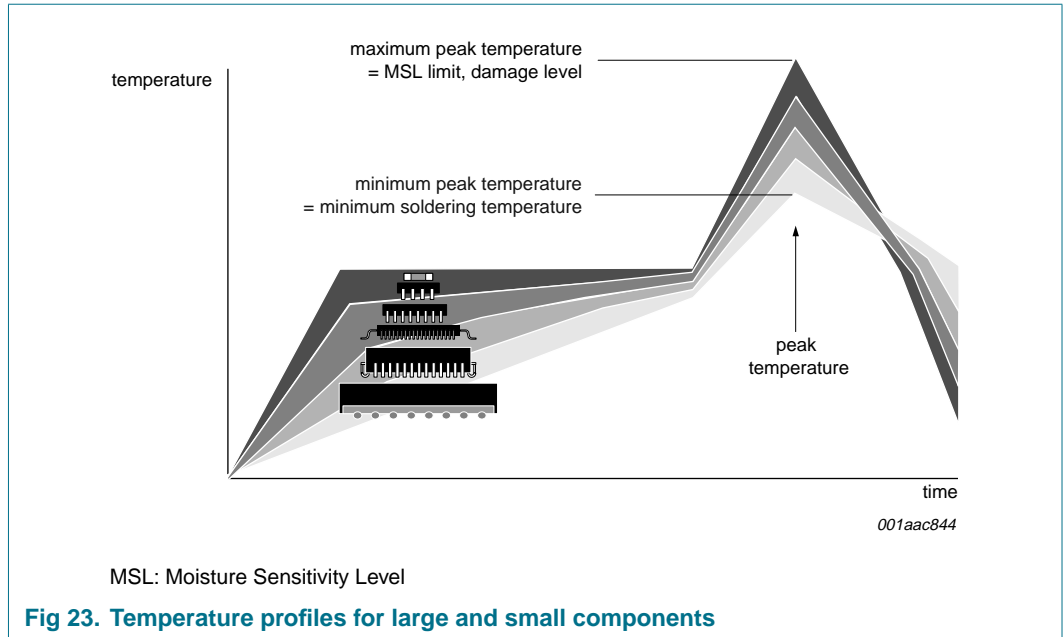

For further information on temperature profiles, refer to Application Note AN10365 “Surface mount reflow soldering description”.

17. Abbreviations

Table 10. Abbreviations

Acronym	Description
BTL	Bridge Tied Load
CMOS	Complementary Metal Oxide Silicon
DAP	Die Attach Paddle
ESD	ElectroStatic Discharge
NPN	Negative-Positive-Negative
PCB	Printed-Circuit Board
PNP	Positive-Negative-Positive
RMS	Root Mean Squared
THD	Total Harmonic Distortion

18. Revision history

Table 11. Revision history

Document ID	Release date	Data sheet status	Change notice	Supersedes
SA58631_2	20071012	Product data sheet	-	SA58631_1
Modifications:		<ul style="list-style-type: none">• The format of this data sheet has been redesigned to comply with the new identity guidelines of NXP Semiconductors.• Legal texts have been adapted to the new company name where appropriate.• Figure 4: changed incorrect character font• Soldering information updated		
SA58631_1	20060308	Product data sheet	-	-

19. Legal information

19.1 Data sheet status

Document status ^{[1][2]}	Product status ^[3]	Definition
Objective [short] data sheet	Development	This document contains data from the objective specification for product development.
Preliminary [short] data sheet	Qualification	This document contains data from the preliminary specification.
Product [short] data sheet	Production	This document contains the product specification.

[1] Please consult the most recently issued document before initiating or completing a design.

[2] The term 'short data sheet' is explained in section "Definitions".

[3] The product status of device(s) described in this document may have changed since this document was published and may differ in case of multiple devices. The latest product status information is available on the Internet at URL <http://www.nxp.com>.

19.2 Definitions

Draft — The document is a draft version only. The content is still under internal review and subject to formal approval, which may result in modifications or additions. NXP Semiconductors does not give any representations or warranties as to the accuracy or completeness of information included herein and shall have no liability for the consequences of use of such information.

Short data sheet — A short data sheet is an extract from a full data sheet with the same product type number(s) and title. A short data sheet is intended for quick reference only and should not be relied upon to contain detailed and full information. For detailed and full information see the relevant full data sheet, which is available on request via the local NXP Semiconductors sales office. In case of any inconsistency or conflict with the short data sheet, the full data sheet shall prevail.

19.3 Disclaimers

General — Information in this document is believed to be accurate and reliable. However, NXP Semiconductors does not give any representations or warranties, expressed or implied, as to the accuracy or completeness of such information and shall have no liability for the consequences of use of such information.

Right to make changes — NXP Semiconductors reserves the right to make changes to information published in this document, including without limitation specifications and product descriptions, at any time and without notice. This document supersedes and replaces all information supplied prior to the publication hereof.

Suitability for use — NXP Semiconductors products are not designed, authorized or warranted to be suitable for use in medical, military, aircraft, space or life support equipment, nor in applications where failure or

malfunction of a NXP Semiconductors product can reasonably be expected to result in personal injury, death or severe property or environmental damage. NXP Semiconductors accepts no liability for inclusion and/or use of NXP Semiconductors products in such equipment or applications and therefore such inclusion and/or use is at the customer's own risk.

Applications — Applications that are described herein for any of these products are for illustrative purposes only. NXP Semiconductors makes no representation or warranty that such applications will be suitable for the specified use without further testing or modification.

Limiting values — Stress above one or more limiting values (as defined in the Absolute Maximum Ratings System of IEC 60134) may cause permanent damage to the device. Limiting values are stress ratings only and operation of the device at these or any other conditions above those given in the Characteristics sections of this document is not implied. Exposure to limiting values for extended periods may affect device reliability.

Terms and conditions of sale — NXP Semiconductors products are sold subject to the general terms and conditions of commercial sale, as published at <http://www.nxp.com/profile/terms>, including those pertaining to warranty, intellectual property rights infringement and limitation of liability, unless explicitly otherwise agreed to in writing by NXP Semiconductors. In case of any inconsistency or conflict between information in this document and such terms and conditions, the latter will prevail.

No offer to sell or license — Nothing in this document may be interpreted or construed as an offer to sell products that is open for acceptance or the grant, conveyance or implication of any license under any copyrights, patents or other industrial or intellectual property rights.

19.4 Trademarks

Notice: All referenced brands, product names, service names and trademarks are the property of their respective owners.

20. Contact information

For additional information, please visit: <http://www.nxp.com>

For sales office addresses, send an email to: salesaddresses@nxp.com

21. Contents

1 General description 1

2 Features 1

3 Applications 1

4 Quick reference data 2

5 Ordering information 2

6 Block diagram 3

7 Pinning information 3

7.1 Pinning 3

7.2 Pin description 4

8 Functional description 4

8.1 Power amplifier 4

8.2 Mode select pin (MODE) 4

9 Limiting values 5

10 Thermal characteristics 5

11 Static characteristics 6

12 Dynamic characteristics 6

13 Application information 7

14 Test information 7

14.1 Test conditions 7

14.2 BTL application 8

14.3 Single-ended application 13

14.4 General remarks 13

14.5 SA58631TK PCB demo 14

15 Package outline 15

16 Soldering 16

16.1 Introduction to soldering 16

16.2 Wave and reflow soldering 16

16.3 Wave soldering 16

16.4 Reflow soldering 17

17 Abbreviations 18

18 Revision history 19

19 Legal information 20

19.1 Data sheet status 20

19.2 Definitions 20

19.3 Disclaimers 20

19.4 Trademarks 20

20 Contact information 20

21 Contents 21

Please be aware that important notices concerning this document and the product(s) described herein, have been included in section 'Legal information'.



© NXP B.V. 2007.

All rights reserved.

For more information, please visit: <http://www.nxp.com>
 For sales office addresses, please send an email to: salesaddresses@nxp.com

Date of release: 12 October 2007
 Document identifier: SA58631_2