



INTEGRATED CIRCUIT

TECHNICAL DATA

TA7609P

TOSHIBA BIPOLAR LINEAR INTEGRATED CIRCUIT

SILICON MONOLITHIC

DEFLECTION COMBINATION FOR COLOR AND MONOCHROME TELEVISION RECEIVERS.

o FUNCTION

HORIZONTAL SECTION

- . Sync Separator
- . Saw Tooth Wave Type AFC
- . $2f_H$ Horizontal Oscillator
- . Flip-Flop
- . SCR Type X-Ray Protector
- . Horizontal Pre-Driver
- . Internal Zener Diode Regulated Supply

VERTICAL SECTION

- . Vertical Sync Amplifier
- . Vertical Oscillator
- . Ramp Wave Shaper
- . Vertical Pre-Driver

o FEATURES

HORIZONTAL SECTION

- . Excellent Temperature Stability of Oscillator Frequency
- . Exact 50% Duty Cycle Output Due to 315kHz Oscillator and Flip-Flop

VERTICAL SECTION

- . Excellent Inter-Race

MAXIMUM RATINGS ($T_a=25^{\circ}\text{C}$)

CHARACTERISTIC	SYMBOL	RATING	UNIT
Horizontal Supply Current	ICC15	40	mA
Horizontal Output Current	IO4	60	mA _p
Horizontal Output Operating Current	IO4 opr	30	mA
Composite Signal Input Voltage	BV16	5	V _{p-p}
AFC Input Voltage	BV1	8	V _{p-p}
Vertical Supply Voltage	VCC11	15	V
Vertical Sync Input Voltage	BV12	5	V _{p-p}
Vertical Output Current	IO7	-5	mA
Power Dissipation (Note)	P _D	800	mW
Operating Temperature Range	T _{opr}	-20 ~ 65	$^{\circ}\text{C}$
Storage Temperature Range	T _{stg}	-55 ~ 150	$^{\circ}\text{C}$

Note : Derated above $T_a=25^{\circ}\text{C}$ in the proportion of $6.4\text{mW}/^{\circ}\text{C}$.

Unit in mm

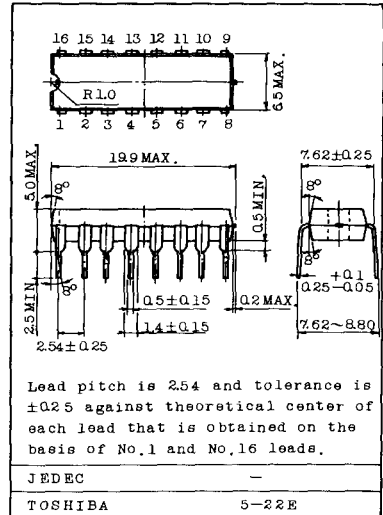

Lead pitch is 2.54 and tolerance is ± 0.25 against theoretical center of each lead that is obtained on the basis of No.1 and No.16 leads.

JEDEC

TOSHIBA

5-22E



BLOCK DIAGRAM

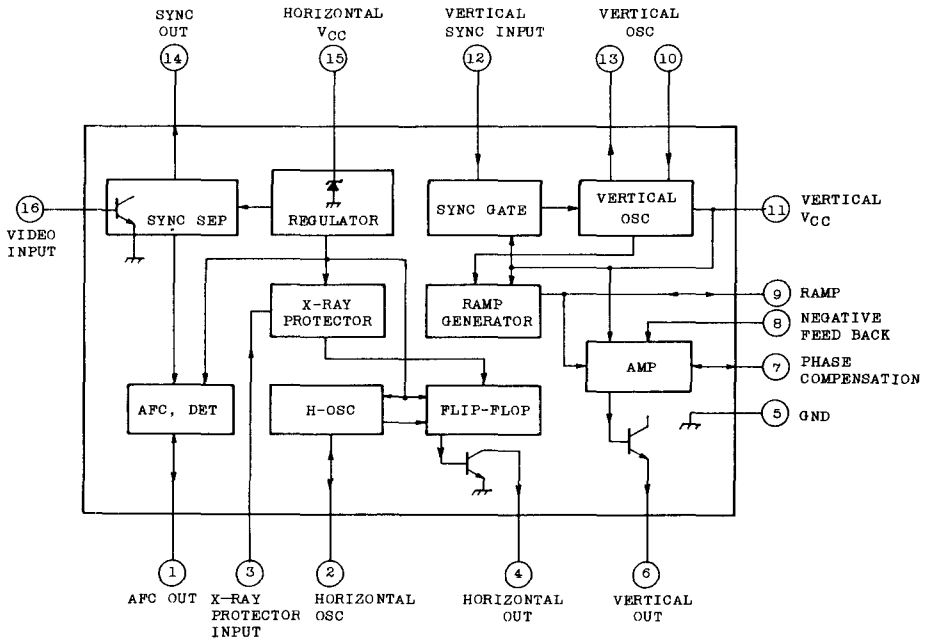



ELECTRICAL CHARACTERISTICS (Ta=25°C)

HORIZONTAL STAGE

CHARACTERISTIC	SYMBOL	TEST CIR-CUIT	TEST CONDITION	MIN.	TYP.	MAX.	UNIT
Zener Regulating Voltage	VCC15	1	-	8.9	9.8	10.9	V
Recommended Supply Current	ICC15	1	-	20	25	30	mA
Sync Sep Sensitivity	IIN16	3	-	-	13	56	μA
Sync Tip Output Voltage	VOH14	3	-	7.4	8.3	9.0	V
Sync Bottom Output Voltage	VOL14	3	-	-	0.2	0.5	V
Sync Sep Delay Time (1)	tpdr	4	-	-	-	100	nsec
Sync Sep Delay Time (2)	tpdf	4	-	-	-	100	nsec
H-Free Run Frequency	fH	5	-	15234	15734	16234	Hz
AFC Output Current	IO1	7	-	2.15	3.08	4.42	mA
AFC Clamp Voltage	VCL	6	-	3.9	4.5	5.1	V
Horizontal Output Residual Output Voltage	VOL4	8	-	-	0.08	0.3	V
Horizontal Output Pulse Width	t04	8	-	30.78	31.78	32.78	μsec
Sensitivity of Phase Det.	μ	9	-	-	0.16	-	V/sec
Sensitivity of Oscillator	β	9	-	-	1170	-	Hz/V
Loop Gain	fC	9	-	-	187	-	-
Frequency Pull-In Range	ΔfPLL	9	-	-	±600	-	Hz
Frequency Hold-In Range	ΔfHOLD	9	-	-	±1000	-	Hz
X-RAY Prot. Sensitivity	VIN3	10	-	0.77	0.91	1.04	V
X-RAY Protector Input Impedance	RIN3	-	-	0.2	-	-	MΩ
Characteristic of Horizontal Free Run Frequency	ΔfHT	5	-20°C ~ 60°C	0	-100	-350	Hz
Horizontal 8V Supply Current	I15	2	-	8.4	12.5	16	mA

ELECTRICAL CHARACTERISTICS ($T_a=25^\circ$)

VERTICAL STAGE

CHARACTERISTIC	SYMBOL	TEST CIR-CUIT	TEST CONDITION	MIN.	TYP.	MAX.	UNIT
Recommended Supply Voltage	VCC	-	-	10.8	12	13.2	V
Supply Current	I _{CC}	11	-	3.4	4.4	6.1	mA
Vertical Frequency	f _V	12	-	57	60	64.1	Hz
Vertical Pulse Width	t _r	13	-	847	891	933	μsec
Vertical Frequency Pull-In Range	Δf _V PULL	14	-	11.65	12.14	12.68	Hz
Vertical Sync Input Impedance	R _{IN12}	-	-	400	500	600	Ω
Vertical Sync Operating Voltage	V _{IN12}	15	-	0.64	0.72	0.80	V
PIN 9 Maximum Output Voltage	V _{O9}	16	-	7.6	8.1	8.6	V
PIN 9 Output Current	I _{O9}	17	-	12.0	18.2	35.7	mA
PIN 8 Available Minimum Voltage	V _{L8}	18	-	-	2.86	3.7	V
PIN 9 Input Current	I _{9LEAK}	19	-	0.25	0.98	4.50	μA
PIN 8 Input Current	I _{8LEAK}	20	-	0.18	0.94	6.21	μA
Vertical Output Maximum Available Voltage	V _{OH7}	21	-	5.67	6.30	7.13	V
Vertical Output Minimum Voltage	V _{OL7}	22	-	-	-	0.3	V

TEST CIRCUITS

1. ZENER REGULATING VOLTAGE

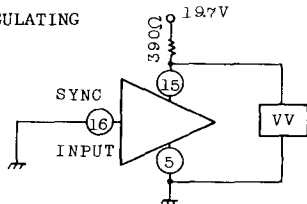

2. 8V SUPPLY CURRENT

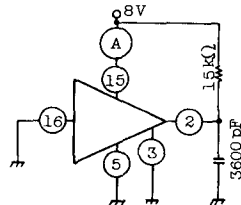

3. SYNC SEP SENSITIVITY*
SYNC TIP OUTPUT VOLTAGE
SYNC BOTTOM OUTPUT VOLTAGE

* at Maximum V_{p14}

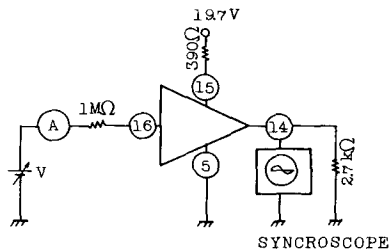

4. SYNC SEP DELAY TIME

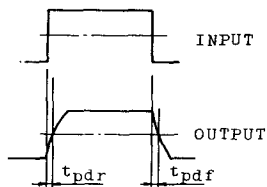
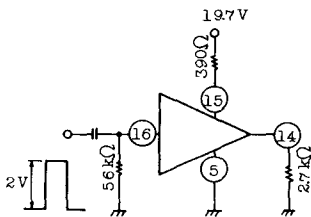

5. HORIZONTAL FREE RUN FREQUENCY

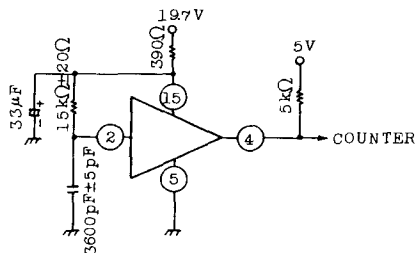

6. AFC CLAMP VOLTAGE

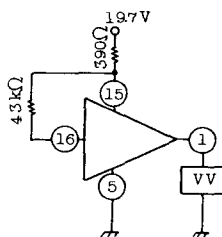

7. AFC OUTPUT CURRENT

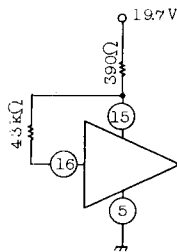

8. HORIZONTAL OUTPUT RESIDUAL OUTPUT VOLTAGE
HORIZONTAL OUTPUT PULSE WIDTH

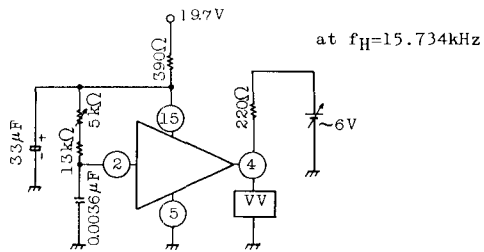

9. HORIZONTAL LOOP GAIN, μ , β

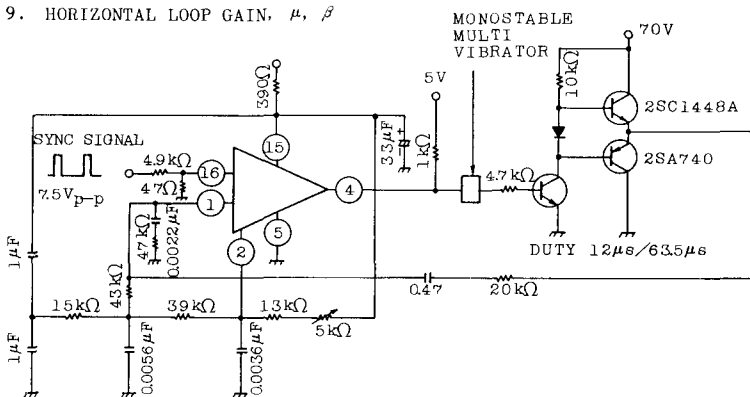

10. X-RAY PROTECTOR SENSITIVITY

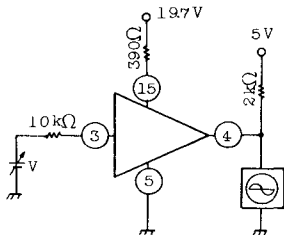

11. VERTICAL SUPPLY CURRENT

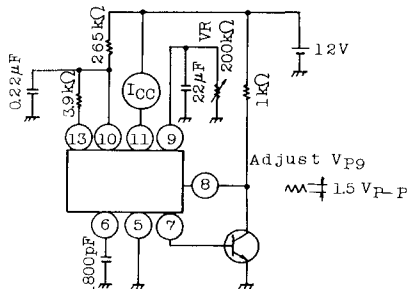

12. VERTICAL FREQUENCY

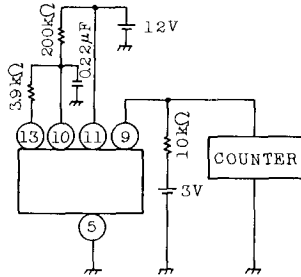

13. VERTICAL PULSE WIDTH

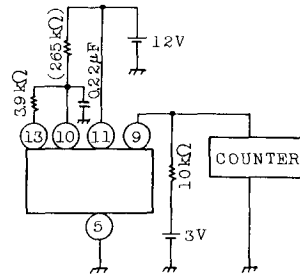

14. VERTICAL FREQUENCY PULL-IN RANGE

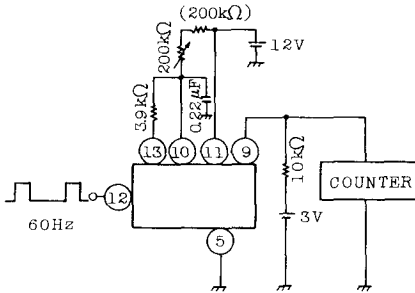

15. VERTICAL SYNC OPERATING VOLTAGE

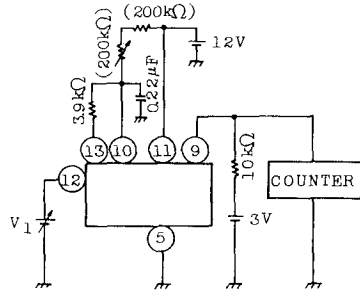

16. PIN 9 (PIN 8) MAXIMUM OUTPUT VOLTAGE

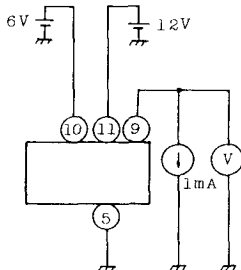

17. PIN 9 OUTPUT CURRENT

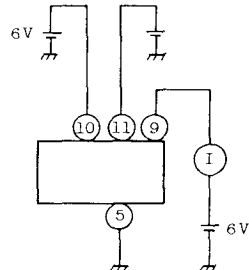

18. PIN 8 AVAILABLE MINIMUM VOLTAGE

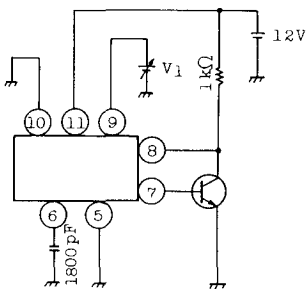

19. PIN 9 INPUT CURRENT

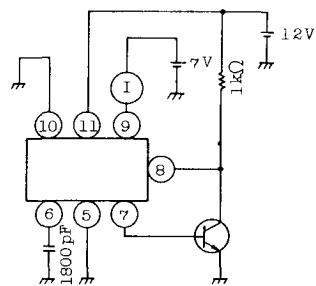

20. PIN 8 INPUT CURRENT

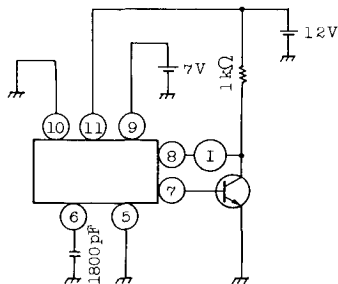

21. VERTICAL OUTPUT MAXIMUM AVAILABLE VOLTAGE

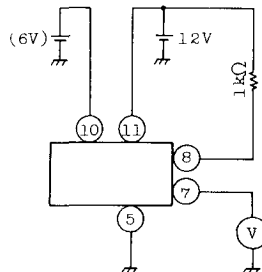

22. VERTICAL OUTPUT MINIMUM VOLTAGE

