

Circuit Breaker for Equipment thermal, 2 pole, Rocker actuation



See below:

Approvals and Compliances

Description

- Thermal circuit breaker
- 1 or 2 pole thermal overload protection
- Positively trip-free release
- High configurability
- Rocker non-illuminated or illuminated
- Snap-in version
- Quick connect terminal 6.3 x 0.8 mm or screw clamp terminal M3.5 x 6 mm (lineside P1, P2)

Applications

- Power tools
- Industrial appliances
- Power supplies

Weblinks

[pdf data sheet](#), [html data sheet](#), [General Product Information](#), [Distributor-Stock-Check](#), [Detailed request for product](#), [Product News](#)

Technical Data

Rated Voltage AC	240 V
Rated Voltage DC	60 V
Rated current range AC	0.05 - 20 A
Conditional short circuit capacity	IEC: Inc, PC1, AC 240 V: 1 kA
Degree of Protection	from front side IP 40 acc. to IEC 60529
Dielectric Strength	4 kVAC
Insulation Resistance	500VDC > 100 MΩ
Lifetime	mechanical: 50'000 switching cycles
	AC: 1 x Ir: 50'000 switching cycles
	DC: 1 x Ir: 50'000 switching cycles

Overload	AC: min. 40 trips @ 6 x Ir DC: min. 40 trips @ 4 x Ir
Allowable Operation Temp.	-10 °C to 55 °C
Vibration Resistance	± 0.75 mm @ 5 - 60 Hz acc. to IEC 60068-2-6, test Fc 10 G @ 60 - 500 Hz acc. to IEC 60068-2-6, test Fc
Shock Resistance	30 G / 18 ms acc. to IEC 60068-2-27, test Ea
Tripping Type	Thermal
Actuation Type	Rocker
Weight	30 - 35 g

Approvals and Compliances

Detailed information on product approvals, code requirements, usage instructions and detailed test conditions can be looked up in [Details about Approvals](#)

SCHURTER products are designed for use in industrial environments. They have approvals from independent testing bodies according to national and international standards. Products with specific characteristics and requirements such as required in the automotive sector according to IATF 16949, medical technology according to ISO 134485 or in the aerospace industry can be offered exclusively with customer-specific, individual agreements by SCHURTER.

Approvals





The approval mark is used by the testing authorities to certify compliance with the safety requirements placed on electronic products.

Approval Reference Type: TA45

Approval Logo	Certificates	Certification Body	Description
	VDE Approvals	VDE	VDE Certificate Number: 40019880
	UL Approvals	UL	UL File Number: E71572
	CQC Approvals	CQC	CCC Certificate Number: 2013010307660082

Product standards

Product standards that are referenced

Organization	Design	Standard	Description
	Designed according to	IEC 60934	Circuit-breakers for equipment (CBE)
	Designed according to	UL 1077	Standard for Supplementary Protectors for Use in Electrical Equipment
	Designed according to	CSA C22.2 No. 235	Supplementary Protectors
	Designed according to	GB 17701	Circuit-breaker for equipment





Application standards

Application standards where the product can be used

Organization	Design	Standard	Description
	Designed for applications acc.	IEC/UL 60950	IEC 60950-1 includes the basic requirements for the safety of information technology equipment.

Compliances

The product complies with following Guide Lines

Identification	Details	Initiator	Description
	CE declaration of conformity	SCHURTER AG	The CE marking declares that the product complies with the applicable requirements laid down in the harmonisation of Community legislation on its affixing in accordance with EU Regulation 765/2008.
	RoHS	SCHURTER AG	EU Directive RoHS 2011/65/EU
	China RoHS	SCHURTER AG	The law SJ / T 11363-2006 (China RoHS) has been in force since 1 March 2007. It is similar to the EU directive RoHS.
	REACH	SCHURTER AG	On 1 June 2007, Regulation (EC) No 1907/2006 on the Registration, Evaluation, Authorization and Restriction of Chemicals 1 (abbreviated as "REACH") entered into force.

Dimension [mm]

Quick connect terminal

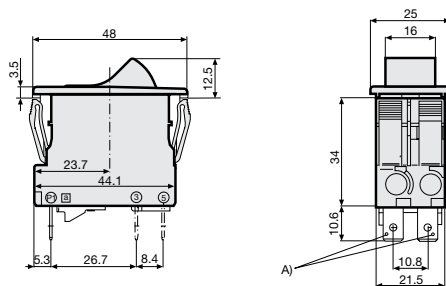

A) Quick connect terminal, IEC 61210, A6.3-0.8 mm

Screw terminal

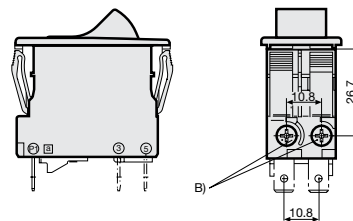

B) Screw type M3, 5x6 (Philips Form H), maximum torque 1 Nm

Accessories / factory mounted
 AZM01 / Collar with cover, IP54

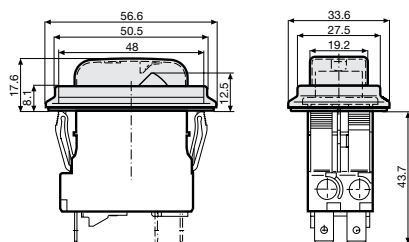

AZM02 / Raised collar with cover, narrow, IP54
 AZM03 / Raised collar, IP40

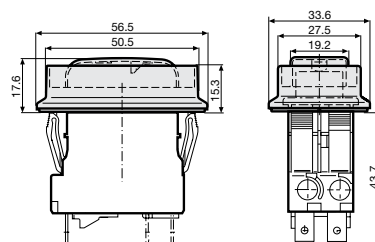

AZM10 / Collar with cover, narrow, IP54

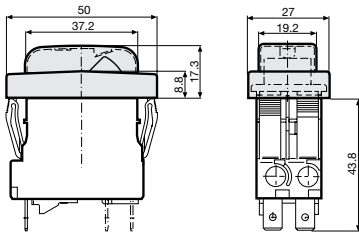

AZM11 / Partially raised collar with cover, narrow, IP54
 AZM12 / Partially raised collar without cover, narrow, IP40

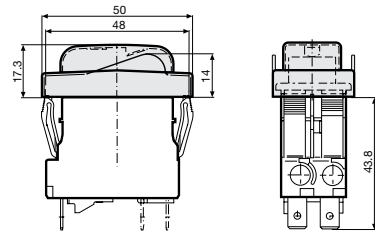

AZM13 / Raised collar narrow, IP40

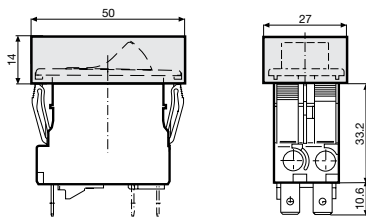

AZM14 / Raised collar with cover narrow, IP54

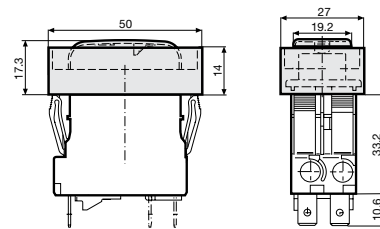

Cut-out and pin-out

Cut-out snap-in type

Pin-out

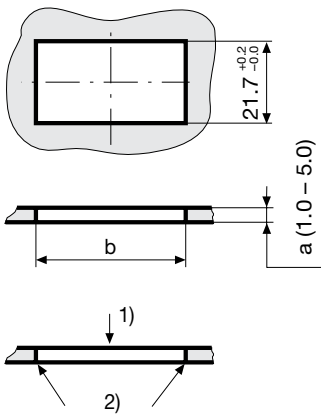

a	b
1.0	44,5...45,0
1.5	44,5...45,0
2.0	44,7...45,2
2.5	44,7...45,2
3.0	44,8...45,3
4.0	44,9...45,4
5.0	45,0...45,5

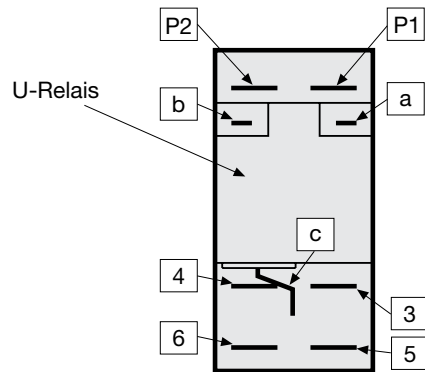

- 1) Assemble
- 2) edge must be sharp

Diagrams

1 pole thermal overload protection

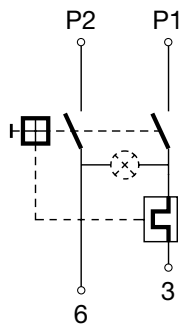

1 pole thermal overload protection, Shunt terminal

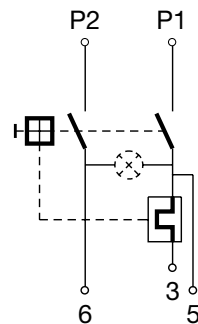

2 pole thermal overload protection

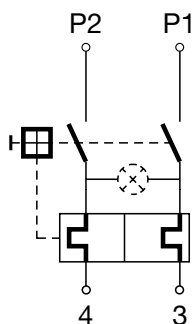

2 pole thermal overload protection, Shunt terminal

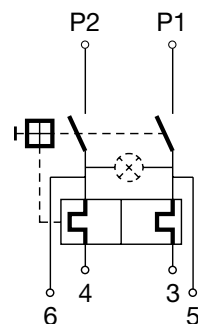

Effect of ambient temperature

The units are calibrated for an ambient temperature of +23°C. To determine the rated current for a lower or higher ambient temperature, use a correction factor (typical value) from the table below:

Ambient Temperature [°C]	Correction factor
-10	0.89
-5	0.91
0	0.92
+23	1.00
+30	1.03
+40	1.08
+55	1.16

Example: Rated current = 5 A, Environmental temperature = 40 °C, --> Correction factor = 1.08, Resulting current = 5.5 A --> Fount to next higher rated current: 6 A

Time-Current-Curves

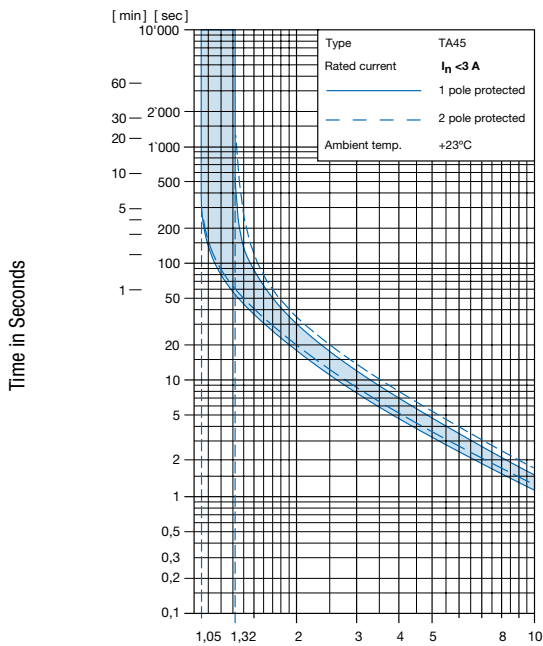

Multiple of Rated Current I_n

Reference Temperature +23°

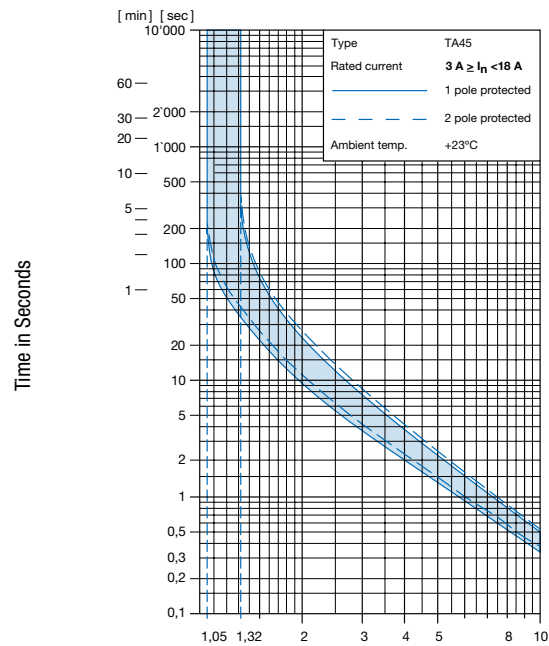

Multiple of Rated Current I_n

Reference Temperature +23°

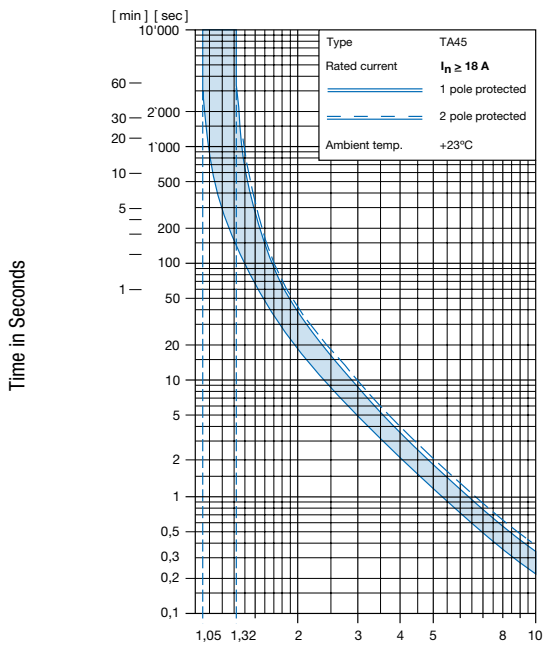

Multiple of Rated Current I_n

Reference Temperature +23°

Config. Code

TA45 - AK2 W F 120 A2 - AZM11

The characters are placeholders for the correspondingly keys of selections from the key tables.

TA45 - **AK2** W F 120 A2 - AZM11 = Basic function

Basic function	Configuration key
2-pole, rocker, 1pole overload protection, flat connection, illuminated 220 V...240 V	A12
2-pole, rocker, 1pole overload protection, flat connection, illuminated 110 V...120 V	A14
2-pole, rocker, 1pole overload protection, flat connection, illuminated 20 V...26 V	A17
2-pole, rocker, 1pole overload protection, flat connection, illuminated 10 V...13 V	A18
2-pole, rocker, 1pole overload protection, flat connection, illuminated 4 V...7 V	A19
2-pole, rocker, 1pole overload protection, shunt terminal, flat connection, illuminated 220 V...240 V	A22
2-pole, rocker, 1pole overload protection, shunt terminal, flat connection, illuminated 110 V...120 V	A24
2-pole, rocker, 1pole overload protection, shunt terminal, flat connection, illuminated 20 V...26 V	A27
2-pole, rocker, 1pole overload protection, shunt terminal, flat connection, illuminated 10 V...13 V	A28
2-pole, rocker, 1pole overload protection, shunt terminal, flat connection, illuminated 4 V...7 V	A29
2-pole, rocker, 2pole overload protection, flat connection, illuminated 220 V...240 V	A32
2-pole, rocker, 2pole overload protection, flat connection, illuminated 110 V...120 V	A34
2-pole, rocker, 2pole overload protection, flat connection, illuminated 20 V...26 V	A37
2-pole, rocker, 2pole overload protection, flat connection, illuminated 10 V...13 V	A38
2-pole, rocker, 2pole overload protection, flat connection, illuminated 4 V...7 V	A39
2-pole, rocker, 2pole overload protection, shunt terminal, flat connection, illuminated 220 V...240 V	A42
2-pole, rocker, 2pole overload protection, shunt terminal, flat connection, illuminated 110 V...120 V	A44
2-pole, rocker, 2pole overload protection, shunt terminal, flat connection, illuminated 20 V...26 V	A47
2-pole, rocker, 2pole overload protection, shunt terminal, flat connection, illuminated 10 V...13 V	A48
2-pole, rocker, 2pole overload protection, shunt terminal, flat connection, illuminated 4 V...7 V	A49
2-pole, rocker, 1pole overload protection, screw connection, illuminated 220 V...240 V	A62
2-pole, rocker, 1pole overload protection, screw connection, illuminated 110 V...120 V	A64
2-pole, rocker, 1pole overload protection, screw connection, illuminated 20 V...26 V	A67
2-pole, rocker, 1pole overload protection, screw connection, illuminated 10 V...13 V	A68
2-pole, rocker, 1pole overload protection, screw connection, illuminated 4 V...7 V	A69
2-pole, rocker, 1pole overload protection, shunt terminal, screw connection, illuminated 220 V...240 V	A72
2-pole, rocker, 1pole overload protection, shunt terminal, screw connection, illuminated 110 V...120 V	A74
2-pole, rocker, 1pole overload protection, shunt terminal, screw connection, illuminated 20 V...26 V	A77
2-pole, rocker, 1pole overload protection, shunt terminal, screw connection, illuminated 10 V...13 V	A78
2-pole, rocker, 1pole overload protection, shunt terminal, screw connection, illuminated 4 V...7 V	A79
2-pole, rocker, 2pole overload protection, screw connection, illuminated 220 V...240 V	A82
2-pole, rocker, 2pole overload protection, screw connection, illuminated 110 V...120 V	A84
2-pole, rocker, 2pole overload protection, screw connection, illuminated 20 V...26 V	A87
2-pole, rocker, 2pole overload protection, screw connection, illuminated 10 V...13 V	A88

Basic function	Configuration key
2-pole, rocker, 2pole overload protection, screw connection, illuminated 4 V...7 V	A89
2-pole, rocker, 2pole overload protection, shunt terminal, screw connection, illuminated 220 V...240 V	A92
2-pole, rocker, 2pole overload protection, shunt terminal, screw connection, illuminated 110 V...120 V	A94
2-pole, rocker, 2pole overload protection, shunt terminal, screw connection, illuminated 20 V...26 V	A97
2-pole, rocker, 2pole overload protection, shunt terminal, screw connection, illuminated 10 V...13 V	A98
2-pole, rocker, 2pole overload protection, shunt terminal, screw connection, illuminated 4 V...7 V	A99
2-pole, rocker, 2pole overload protection, flat connection, without illumination	ABD
2-pole, rocker, 1pole overload protection, shunt terminal, flat connection, without illumination	ABF
2-pole, rocker, 2pole overload protection, shunt terminal, flat connection, without illumination	ABG
2-pole, rocker, 1pole overload protection, flat connection, without illumination	ABT
2-pole, rocker, 2pole overload protection, flat connection, momentary switch, without illumination	AED
2-pole, rocker, 1pole overload protection, shunt terminal, flat connection, momentary switch, without illumination	AEF
2-pole, rocker, 2pole overload protection, shunt terminal, flat connection, momentary switch, without illumination	AEG
2-pole, rocker, 1pole overload protection, flat connection, momentary switch, without illumination	AET
2-pole, rocker, 2pole overload protection, screw connection, without illumination	AHD
2-pole, rocker, 1pole overload protection, shunt terminal, screw connection, without illumination	AHF
2-pole, rocker, 2pole overload protection, shunt terminal, screw connection, without illumination	AHG
2-pole, rocker, 1pole overload protection, screw connection, without illumination	AHT
2-pole, rocker, 2pole overload protection, screw connection, momentary switch, without illumination	AJD
2-pole, rocker, 1pole overload protection, shunt terminal, screw connection, momentary switch, without illumination	AJF
2-pole, rocker, 2pole overload protection, shunt terminal, screw connection, momentary switch, without illumination	AJG
2-pole, rocker, 1pole overload protection, screw connection, momentary switch, without illumination	AJT

TA45 - AK2 **W** F 120 A2 - AZM11 = Actuator colour

Actuator colour	Configuration key
Clear transparent	1
Red transparent	3
Green transparent	4
Orange transparent	6
Black	B
Green	G
Red	R
White	W
Orange	X
Yellow	Y

TA45 - AK2 **W** F 120 A2 - AZM11 = Legend

Legend	Configuration key
embossed	F
white printed	H
black printed	K
white printed	L
black printed	M
white printed	P
black printed	R
white printed	S
black printed	T

TA45 - AK2 W F 120 A2 - AZM11 = Rated current

Rated current	Configuration key
0.05 A	Z05
0.1 A	J01
0.2 A	J02
0.3 A	J03
0.4 A	J04
0.5 A	J05
0.6 A	J06
0.7 A	J07
0.8 A	J08
0.9 A	J09
1.0 A	J10
1.1 A	J11
1.2 A	J12
1.3 A	J13
1.4 A	J14
1.5 A	J15
1.6 A	J16
1.7 A	J17
1.8 A	J18
1.9 A	J19
2.0 A	J20
2.1 A	J21

Other rated currents on request

Rated current	Configuration key
2.2 A	J22
2.3 A	J23
2.5 A	J25
2.8 A	J28
3.0 A	030
3.5 A	035
4.0 A	040
4.5 A	045
5.0 A	050
6.0 A	060
6.5 A	065
7.0 A	070
7.5 A	075
8.0 A	080
9.0 A	090
10.0 A	100
11.0 A	110
12.0 A	120
13.0 A	130
14.0 A	140
15.0 A	150
16.0 A	160
17.0 A	170
18.0 A	180
19.0 A	190
20.0 A	200

Other rated currents on request

TA45 - AK2 W F 120 A2 - AZM11 = Release / lock-out latch

Release / lock-out latch	Configuration key
whithout release / lock-out latch	C0

TA45 - AK2 W F 120 A2 - AZM11 = Accessories

Factory mounted accessories	Configuration key
Without cover	
Collar with cover, IP54	AZM01
Raised collar with cover, IP54	AZM02
Raised collar, IP40	AZM03
Raised collar with cover narrow, IP54	AZM10
Partially raised collar with cover, narrow, IP54	AZM11
Partially raised collarwithout cover, narrow, IP40	AZM12
Raised collar narrow, IP40	AZM13
Raised collar with cover narrow, IP54	AZM14

For subsequent fitting accessories see:

https://www.schurter.com/pdf/english/typ_TA45-ACC.pdf

Variants

Thermal overload protection	Addition	connection type	Illumination	Actuator colour	Legend	Rated current	Accessories	Config. Code	Order Number
1-pole		Quick connect terminal	without illumination	White	embossed	10.0 A	Without cover	TA45-ABTWF100C0	4430.0022
2-pole		Quick connect terminal	without illumination	Black	white printed	15.0 A	Without cover	TA45-ABDBL150C0	4430.1089
2-pole		Quick connect terminal	without illumination	Black	white printed	15.0 A	Without cover	TA45-ABDBS150C0	4430.1328

Most Popular.

Availability for all products can be searched real-time: <https://www.schurter.com/en/Stock-Check/Stock-Check-SCHURTER>

Packaging Unit 1 Pcs

Accessories



Description

[TA45-ACC](#)
 Accessories to TA45