

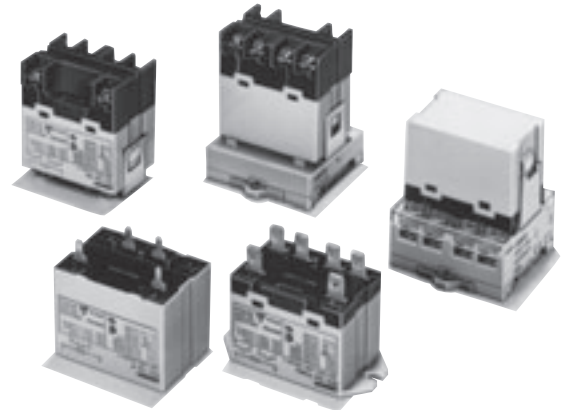

## A High-capacity, High-dielectric-strength Relay Compatible with Momentary Voltage Drops

- No contact chattering for momentary voltage drops up to 50% of rated voltage.
- Wide-range AC-activated coil that handles 100 to 120 or 200 to 240 VAC at either 50 or 60 Hz.
- Miniature size for maximum switching power, particularly for inductive loads.
- Flame-resistance materials (UL94V-0-qualifying) used for all insulation material.
- Quick-connect, screw, and PCB terminals, and DIN track mounting available.
- Conforms to UL, CSA, TUV and meets IEC950.
- Safety design with contact gap of 3 mm.



Note. Accessories: E-bracket, Adapter, Front-connecting socket and Cover sold separately.



**RoHS Compliant**

### Model Number Legend

G7L-  -  -  -    
1 2 3 4 5

- |  |   |   |
|--|---|---|
| <b>1. Number of Poles</b><br>1: 1 pole<br>2: 2 poles | <b>3. Terminal Shape</b><br>T: Quick connect terminals (#250)<br>B: Screw terminals<br>P: PCB terminals | <b>4. Mounting Construction</b><br>Blank: E-bracket<br>UB : Upper bracket |
| <b>2. Contact Form</b><br>A: □PST-NO                 | <b>5. Special Functions</b><br>J : With test button   |   |

### Model Configuration

Terminal		Quick-connect terminals	Screw terminals	PCB terminals	
Classification		Contact form			
E-bracket mounting (E-bracket is sold separately)	–	SPST-NO	G7L-1A-T	G7L-1A-B	–
	–	DPST-NO	G7L-2A-T	G7L-2A-B	–
	With test button	SPST-NO	G7L-1A-TJ	G7L-1A-BJ	–
		DPST-NO	G7L-2A-TJ	G7L-2A-BJ	–
Upper bracket mounting	–	SPST-NO	G7L-1A-TUB	G7L-1A-BUB	–
	–	DPST-NO	G7L-2A-TUB	G7L-2A-BUB	–
	With test button	SPST-NO	G7L-1A-TUBJ	G7L-1A-BUBJ	–
		DPST-NO	G7L-2A-TUBJ	G7L-2A-BUBJ	–
PCB mounting	–	SPST-NO	–	–	G7L-1A-P
	–	DPST-NO	–	–	G7L-2A-P

### Application Examples

- Compressors for air conditioners and heater switching controllers.
- Switching controllers for power tools or motors.
- Power controllers for water heaters.
- Power controllers for dryers.
- Lamp controls, motor drivers, and power supply switching in copy machines, facsimile machines, and other office equipment.
- Lighting controllers.
- Power controllers for packers or food processing equipment.
- Magnetron control in microwaves.
- Power controllers for Uninterruptible Power Supply (UPS)

### List of E-bracket Mounting Models

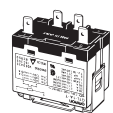
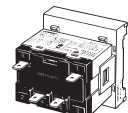
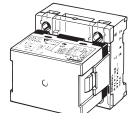
Mounting				E-brackets	DIN Track Mounting Adapter	Front-connecting Socket
Terminal	Contact form	Model	Test button			
Quick-connect terminals	SPST-NO	G7L-1A-T	–	○	○	○
		G7L-1A-TJ	With test button	○	○	○
	DPST-NO	G7L-2A-T	–	○	○	○
		G7L-2A-TJ	With test button	○	○	○
Screw terminals	SPST-NO	G7L-1A-B	–	○	○	–
		G7L-1A-BJ	With test button	○	○	–
	DPST-NO	G7L-2A-B	–	○	○	–
		G7L-2A-BJ	With test button	○	○	–

Note. Accessories: E-bracket (R99-07), Adapter (P7LF-D), Front-connecting socket (P7LF-06) and Cover (P7LF-C) sold separately.

## Ordering Information

### E-bracket/Adapter/Socket Mounting

#### Quick-connect Terminal

Number of poles	Model	Rated coil voltage	Minimum packing unit
1 pole	G7L-1A-T	AC: 12, 24, 100/120, 200/240	20 pcs./tray
		DC: 6, 12, 24, 48, 100	
2 poles	G7L-2A-T	AC: 12, 24, 50, 100/120, 200/240	
		DC: 6, 12, 24, 48, 100	

#### Upper Bracket Mounting

#### Quick-connect Terminal

Number of poles	Model	Rated coil voltage	Minimum packing unit
1 pole	G7L-1A-TUB	AC: 12, 24, 100/120, 200/240	20 pcs./tray
		DC: 6, 12, 24, 48, 100	
2 poles	G7L-2A-TUB	AC: 12, 24, 50, 100/120, 200/240	
		DC: 6, 12, 24, 48, 100	

### E-bracket/Adapter Mounting

#### Screw Terminal

Number of poles	Model	Rated coil voltage	Minimum packing unit
1 pole	G7L-1A-B	AC: 12, 24, 100/120, 200/240	20 pcs./tray
		DC: 6, 12, 24, 48, 100	
2 poles	G7L-2A-B	AC: 12, 24, 100/120, 200/240	
		DC: 12, 24, 48, 100	

#### Upper Bracket Mounting

#### Screw Terminal

Number of poles	Model	Rated coil voltage	Minimum packing unit
1 pole	G7L-1A-BUB	AC: 24, 100/120, 200/240	20 pcs./tray
		DC: 6, 12, 24, 48, 100	
2 poles	G7L-2A-BUB	AC: 12, 24, 50, 100/120, 200/240	
		DC: 6, 12, 24, 48, 100	

### PCB Mounting

Number of poles	Model	Rated coil voltage	Minimum packing unit
1 pole	G7L-1A-P	AC: 100/120, 200/240	20 pcs./tray
		DC: 12, 24, 48, 100	
2 poles	G7L-2A-P	AC: 24, 100/120, 200/240	
		DC: 6, 12, 24, 48, 100	

### DIN Track Mounting Accessories

Applicable products	Name	Model	Minimum packing unit
Adaptor Surface Connection Socket	DIN Track	PPF-100N	10 pcs.
		PPF-50N	
		PPF-100N2	
	End plate	PPF-M	
	Spacer	PPF-S	

Note. Order the models above in increments of the minimum quantity packaged.

### E-bracket/Adapter/Socket Mounting (with test button)

#### Quick-connect Terminal

Number of poles	Model	Rated coil voltage	Minimum packing unit
1 pole	G7L-1A-TJ	AC: 24, 100/120, 200/240	20 pcs./tray
		DC: 12, 24, 48, 100	
2 poles	G7L-2A-TJ	AC: 24, 100/120, 200/240	
		DC: 6, 12, 24, 48, 100	

#### Upper Bracket Mounting (with test button)

#### Quick-connect Terminal

Number of poles	Model	Rated coil voltage	Minimum packing unit
1 pole	G7L-1A-TUBJ	AC: 24, 100/120, 200/240	20 pcs./tray
		DC: 6, 12, 24, 48, 100	
2 poles	G7L-2A-TUBJ	AC: 12, 24, 50, 100/120, 200/240	
		DC: 6, 12, 24, 48, 100	

### E-bracket/Adapter Mounting (with test button)

#### Screw Terminal

Number of poles	Model	Rated coil voltage	Minimum packing unit
1 pole	G7L-1A-BJ	AC: 12, 24, 100/120, 200/240	20 pcs./tray
		DC: 12, 24	
2 poles	G7L-2A-BJ	AC: 24, 100/120, 200/240	
		DC: 12, 24, 48, 100	

#### Upper Bracket Mounting (with test button)

#### Screw Terminal

Number of poles	Model	Rated coil voltage	Minimum packing unit
1 pole	G7L-1A-BUBJ	AC: 24, 100/120, 200/240	20 pcs./tray
		DC: 6, 12, 24, 48	
2 poles	G7L-2A-BUBJ	AC: 24, 100/120, 200/240	
		DC: 6, 12, 24, 48, 100	

Note 1. Please add the coil rated voltage (V) to the model number when ordering.

Example: G7L-1A-T AC12

In addition, the delivered product and its package will be marked with voltage specification as "□□ VDC".

Note 2. Refer to the precautions on **PCB Relays provided in General**

**Information of the Relay Product Data Book**, and "w-□-3" for coil characteristics of AC operation.

### E-bracket/Adaptor/Socket/Cover

Applicable Relay models	Name	Model	Minimum packing unit
G7L-1A-T G7L-1A-TJ G7L-1A-B G7L-1A-BJ G7L-2A-T G7L-2A-TJ G7L-2A-B G7L-2A-BJ	E-bracket	R99-07	10 pcs.
G7L-1A-T G7L-1A-TJ G7L-2A-T G7L-2A-TJ	Adapter	P7LF-D	1 pcs.
G7L-1A-T G7L-1A-TJ G7L-2A-T G7L-2A-TJ	Front-connecting Socket	P7LF-06	1 pcs.
G7L-1A-B G7L-1A-BJ G7L-1A-BUB G7L-1A-BUBJ G7L-2A-B G7L-2A-BJ G7L-2A-BUB G7L-2A-BUBJ	Cover	P7LF-C	1 pcs.

Note. Order the models above in increments of the minimum quantity packaged.

## ■ Ratings

### Coil

Item	Rated current (mA)	Coil resistance (Ω)	Coil inductance (H)		Must operate voltage	Must release voltage	Max. permissible voltage	Power consumption (VA-W)
			Armature ON	Armature OFF				
Rated voltage			On the basis of rated voltage					
12 VAC	142	/	/	/	75% max.	15% min.	110%	Approx. 1.7 to 2.5
24 VAC	71							
50 VAC	34							
100 to 120 VAC	17.0 to 20.4							
200 to 240 VAC	8.5 to 10.2							
6 VDC	317	18.9	0.09	0.21	75% max.	15% min.	110%	Approx. 1.9
12 VDC	158	75	0.37	0.88				
24 VDC	79	303	1.42	3.54				
48 VDC	40	1220	6.1	15.3				
100 VDC	19	5260	21.3	60.0				

- Note 1. The rated current and coil resistance are measured at a coil temperature of 23°C with tolerances of +15%/-20% for AC rated current and ±15% for DC coil resistance.  
 2. The inductances shown above are reference values.  
 3. Performance characteristic data are measured at a coil temperature of 23°C.  
 4. The maximum allowable coil voltage refers to the maximum value in a varying range of operating power voltage, measured at ambient temperature 23°C.  
 5. The "to" (for example "100 to 120") represents the range of rated voltages.

### Contacts

Item	Contact Form load	G7L-1A-T□ G7L-1A-B□		G7L-2A-T□ G7L-2A-B□		G7L-1A-P G7L-2A-P	
		Resistive load	Inductive load (cosφ = 0.4)	Resistive load	Inductive load (cosφ = 0.4)	Resistive load	Inductive load (cosφ = 0.4)
Contact type	Double break						
Contact material	Ag alloy						
Rated load	30 A at 220 VAC	25 A at 220 VAC	25 A at 220 VAC	20 A at 220 VAC			
Rated carry current	30 A		25 A		20 A		
Max. switching voltage	250 VAC						
Max. switching current	30 A		25 A		20 A		

Note. When using B-series (screw) products, since the screw diameter of the contact terminal is M4, be careful that the contact current should be 20 A or less according to JET standard (electrical appliance and material control law of Japan).

## ■ Characteristics

Contact resistance *1	50 mΩ max.	
Operate time *2	30 ms max.	
Release time *3	30 ms max.	
Max. operating frequency	Mechanical	1,800 operations/hr
	Rated load	1,800 operations/hr
Insulation resistance *3	1,000 MΩ min	
Dielectric strength	Between coil and contacts	4,000 VAC min., 50/60 Hz for 1 min
	Between contacts of same polarity Between contacts of different polarity (DPST-NO model)	2,000 VAC, 50/60 Hz for 1 min
Impulse withstand voltage	10,000 V between coil and contact *4	
Vibration resistance	Destruction	10 to 55 to 10 Hz, 0.75 mm single amplitude (1.5 mm double amplitude)
	Malfunction	10 to 55 to 10 Hz, 0.75 mm single amplitude (1.5 mm double amplitude)
Shock resistance	Destruction	1,000 m/s <sup>2</sup>
	Malfunction	100 m/s <sup>2</sup>
Endurance	Mechanical	1,000,000 operations min. (at 1,800 operations/hr)
	Electrical *5	100,000 operations min. (at 1,800 operations/hr under rated load)
Failure rate (P level) (reference value *6)	100 mA at 5 VDC	
Weight	Approx. 90 g: Quick-connect terminal models Approx. 100 g: PCB terminal models Approx. 120 g: Screw terminal models	

- Note. The values given above are initial values.  
 \*1. Measurement conditions: 5 VDC, 1 A, voltage drop method.  
 \*2. Measurement conditions: Rated operating voltage applied, not including contact bounce. Ambient temperature: 23°C  
 \*3. Measurement conditions: The insulation resistance was measured with a 500-VDC megohmmeter at the same locations as the dielectric strength was measured.  
 \*4. JEC-212 (1981) Standard Impulse Wave Type (1.2x50μs).  
 \*5. Ambient temperature: 23°C  
 \*6. This value was measured at a switching frequency of 60 operations/min.

Ambient operating temperature	-25°C to 60°C (with no icing or condensation)
Ambient operating humidity	5% to 85%

## ■ Engineering Data

**G7L-1A-T (TJ) (TUB) (TUBJ)  
G7L-1A-B (BJ) (BUB) (BUBJ)  
Maximum Switching Power**

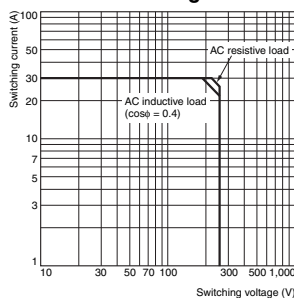

**G7L-2A-T (TJ) (TUB) (TUBJ)  
G7L-2A-B (BJ) (BUB) (BUBJ)  
Maximum Switching Power**

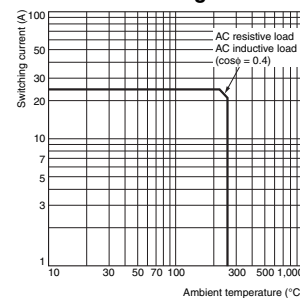

**G7L-1A-P  
G7L-2A-P  
Maximum Switching Power**

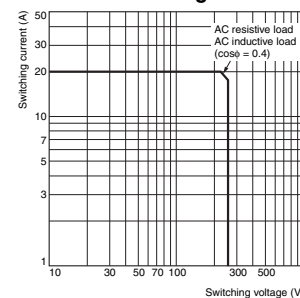

**Ambient Temperature vs. Operate and Release Voltage  
G7L-1A VAC (60 Hz)**

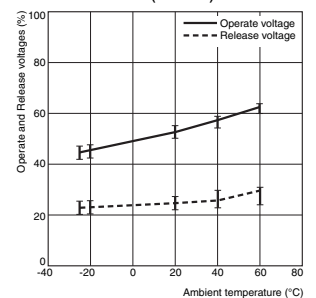

### Endurance

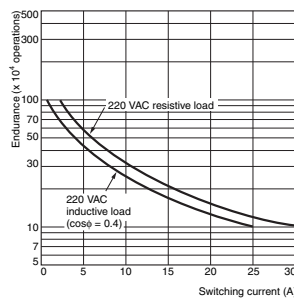

### Endurance

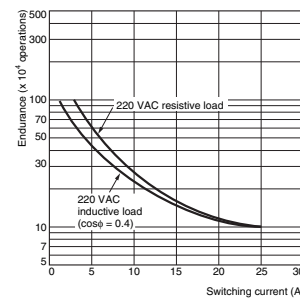

### Endurance

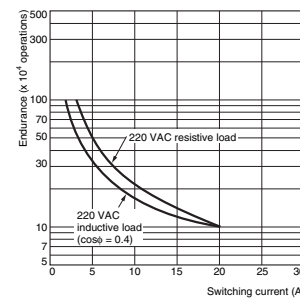

### G7L-1A VDC

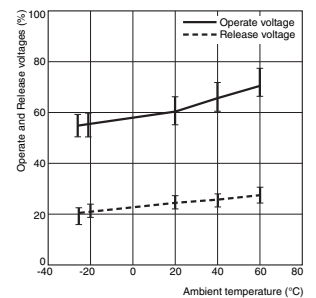

## Ambient Temperature vs. Coil Temperature Rise G7L-1A 120 VAC (50 Hz)

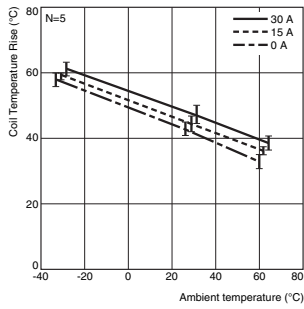

## G7L-1A VDC

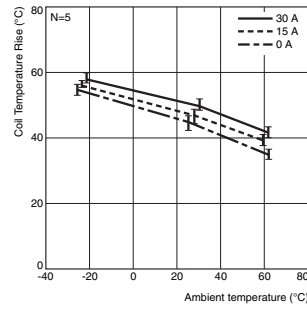

## Shock Malfunction G7L-2A-T (TUB) 100 to 120 VAC

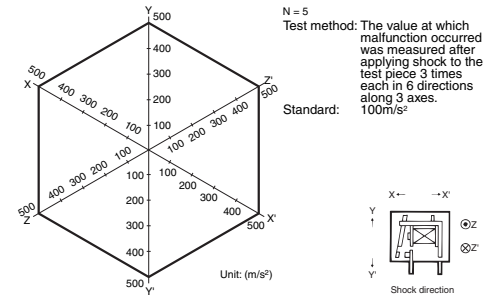

## Momentary Voltage Drop Test G7L-2A-T (TUB) 100 to 120 VAC

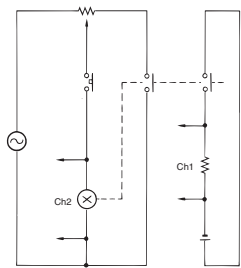

## Wave resulted from test

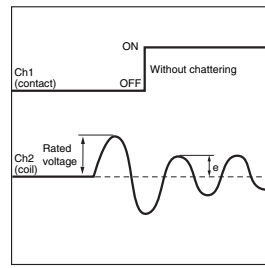

## Voltage distribution of wave e which chattering does not occur.

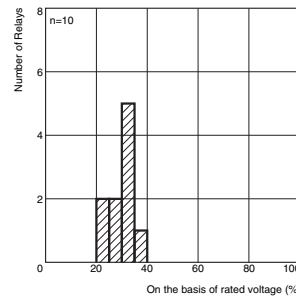

## Characteristic variation resulted from different mounting directions G7L-2A-T (TUB) 100 to 120 VAC

### Operate time

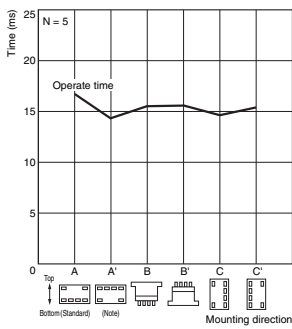

### Release time

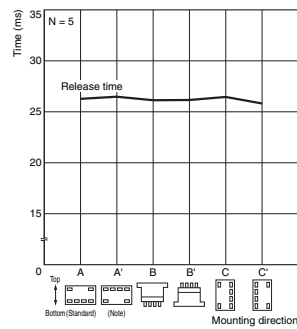

### Operate voltage

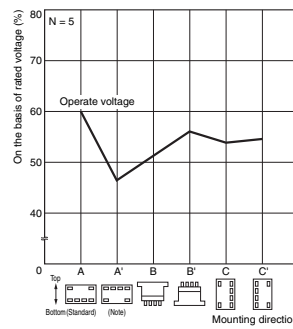

### Release voltage

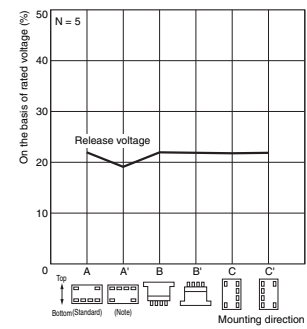

(Note.)The mounting direction A' deteriorates switching performance.

## Actual Load Endurance Test G7L-2A 100 to 200 VAC Operate and Release voltages N = 5

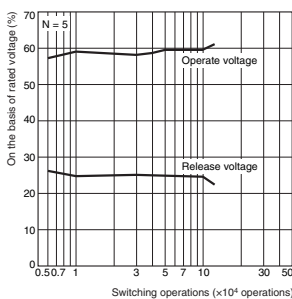

### Contact resistance

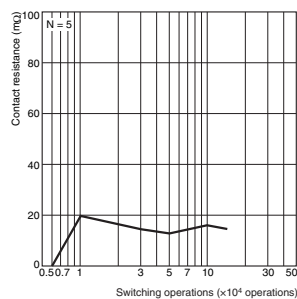

## Operate and Release voltages N = 5

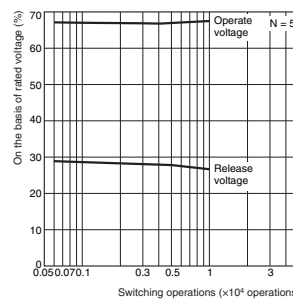

### Contact resistance

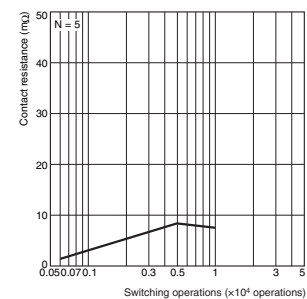

## Load conditions

- 1 φ 220 VAC

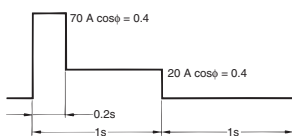

- Applied coil voltage: 100% of rated voltage

## Load conditions

- 1 φ 220 VAC

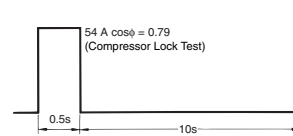

- Applied coil voltage: 100% of rated voltage

## G7L-2A 100 to 200 VAC Operate and Release voltages N = 5

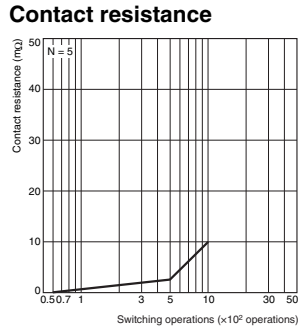
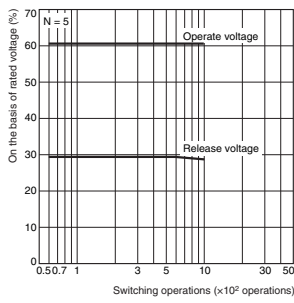

## Operate and Release voltages N = 5

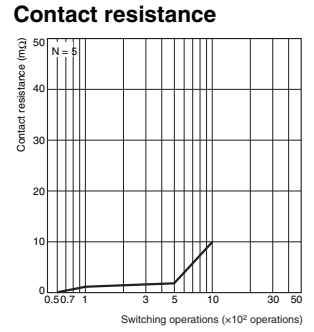
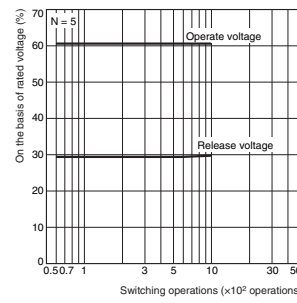

### Load conditions • 1 φ 220 VAC

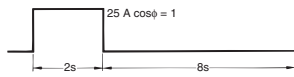

• Applied coil voltage: 75% of rated voltage

### Load conditions • 1 φ 220 VAC

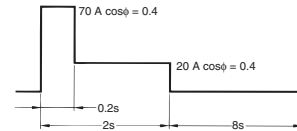

• Applied coil voltage: 75% of rated voltage

## Dimensions

### E-bracket Mounting Quick-connect Terminals

Note. E-brackets are sold separately.

### G7L-1A-T

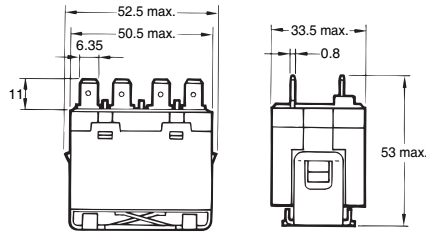
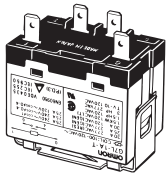

### Terminal Arrangement/ Internal Connections (Top View)

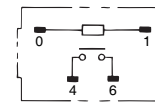

(No coil polarity)  
Note. Refer to page 12 for the coil internal connection diagram

### G7L-2A-T

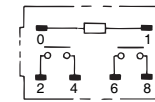
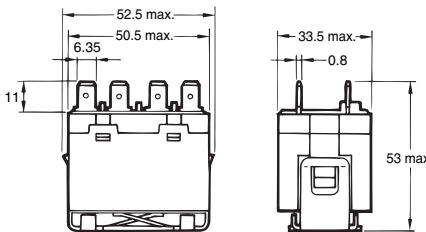
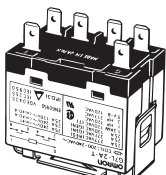

(No coil polarity)  
Note. Refer to page 12 for the coil internal connection diagram

### Mounting Holes

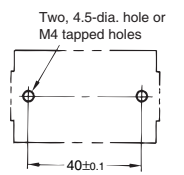

### G7L-1A-TJ (with Test Button)

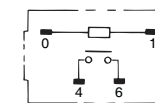
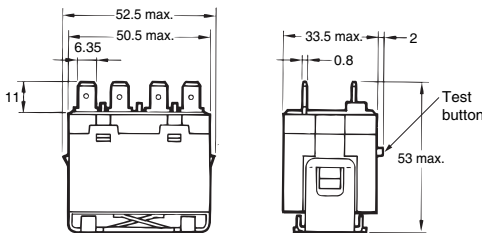
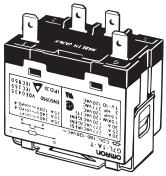

(No coil polarity)  
Note. Refer to page 12 for the coil internal connection diagram

### G7L-2A-TJ (with Test Button)

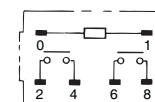
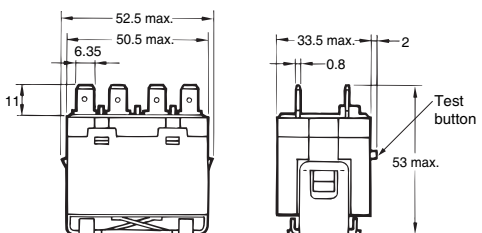
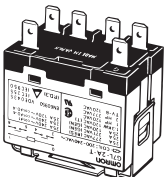

(No coil polarity)  
Note. Refer to page 12 for the coil internal connection diagram

## ● Adapter Mounting Quick-connect Terminals

- Note 1. The DIN Track Mounting Adapter and DIN tracks are sold separately.  
 Note 2. The DIN Track Mounting Adapter can be track-mounted or screw-mounted.

### G7L-1A-T

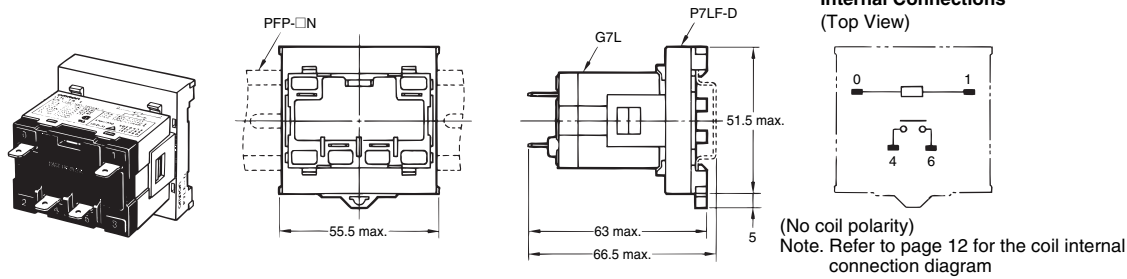

### G7L-2A-T

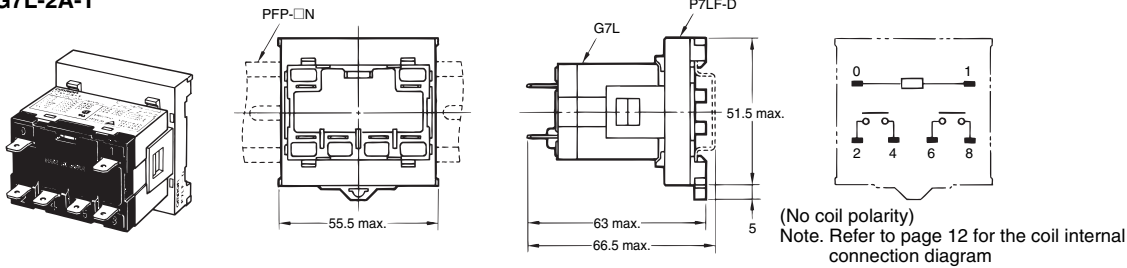

### Mounting Holes

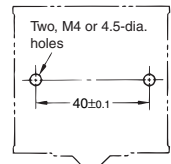

G  
7  
L

### G7L-1A-TJ (with Test Button)

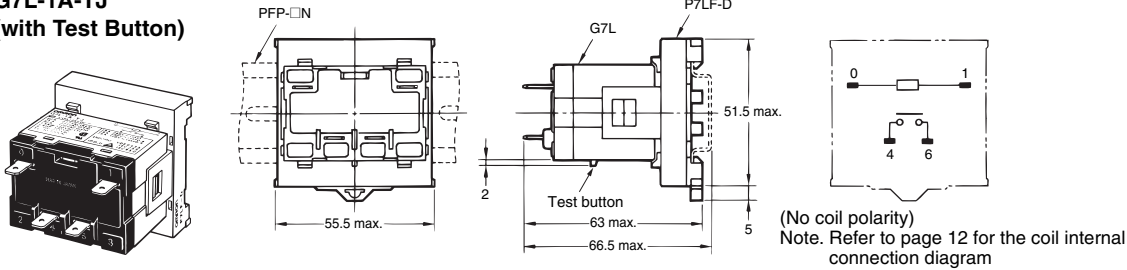

### G7L-2A-TJ (with Test Button)

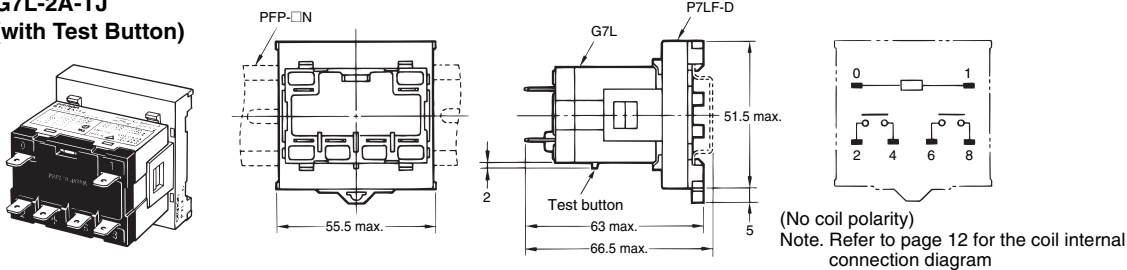

## ● Front-connecting Socket Mounting Quick-connect Terminals

- Note 1. The Front-connecting Socket and DIN tracks are sold separately.  
 Note 2. The Front-connecting Socket can be track-mounted or screw-mounted.

### G7L-1A-T

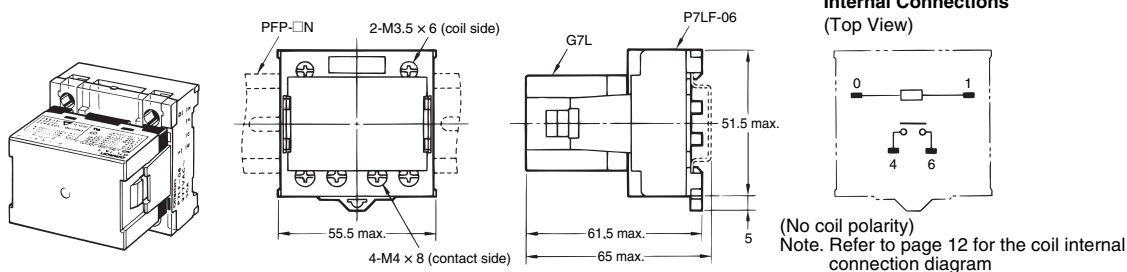

### Mounting Holes

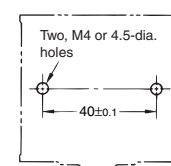

### G7L-2A-T

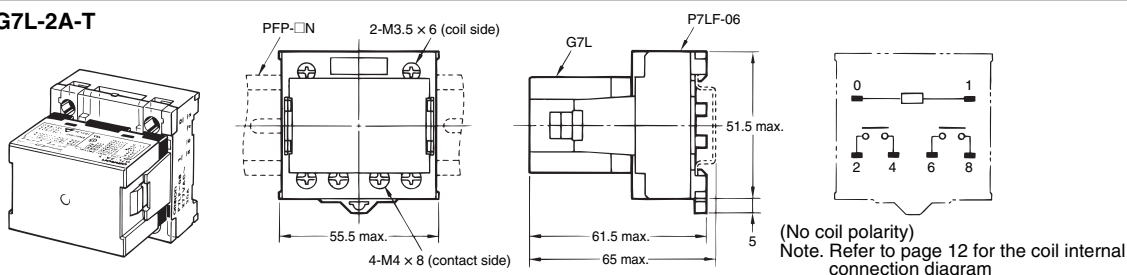

## G7L-1A-TJ (with Test Button)

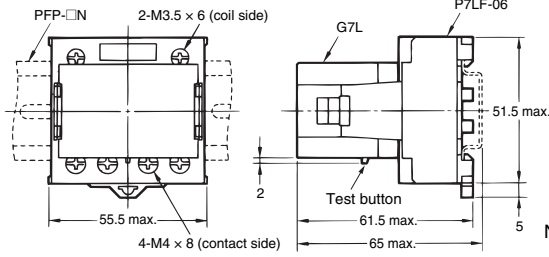
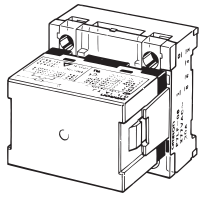

### Terminal Arrangement/ Internal Connections (Top View)

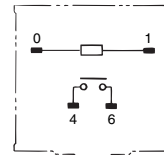

(No coil polarity)  
Note. Refer to page 12 for the coil internal connection diagram

### Mounting Holes

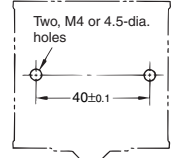

## G7L-2A-TJ (with Test Button)

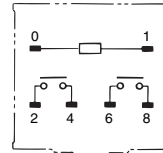
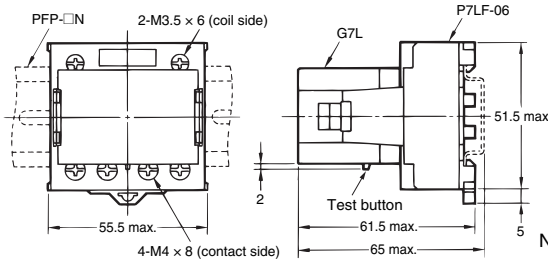
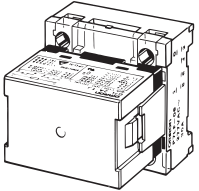

(No coil polarity)  
Note. Refer to page 12 for the coil internal connection diagram

## ● Upper Bracket Mounting Quick-connect Terminals

### G7L-1A-TUB

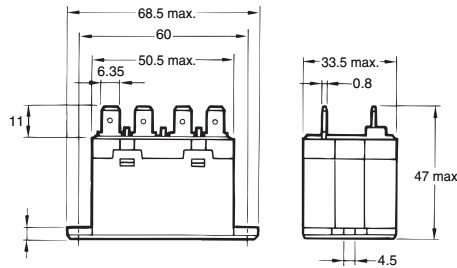
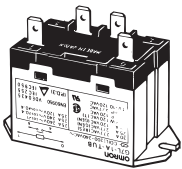

### Terminal Arrangement/ Internal Connections (Top View)

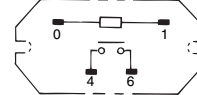

(No coil polarity)  
Note. Refer to page 12 for the coil internal connection diagram

### G7L-2A-TUB

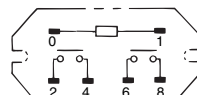
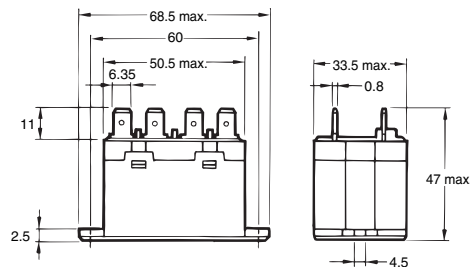
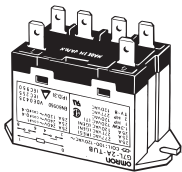

(No coil polarity)  
Note. Refer to page 12 for the coil internal connection diagram

### Mounting Holes

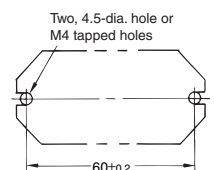

## G7L-1A-TUBJ (with Test Button)

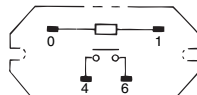
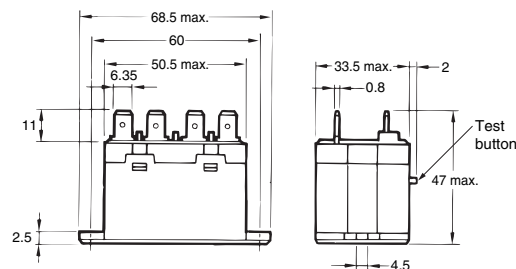
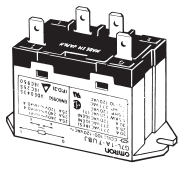

(No coil polarity)  
Note. Refer to page 12 for the coil internal connection diagram

## G7L-2A-TUBJ (with Test Button)

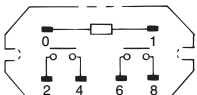
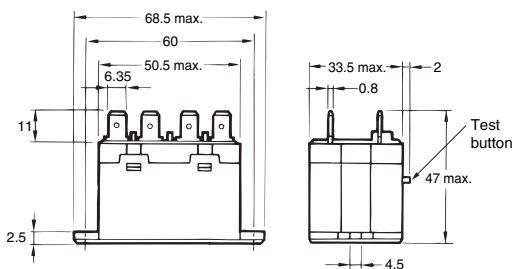
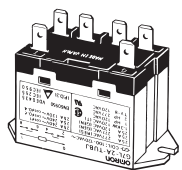

(No coil polarity)  
Note. Refer to page 12 for the coil internal connection diagram

## ● E-bracket Mounting Screw Terminals

Note. E-brackets are sold separately.

### G7L-1A-B

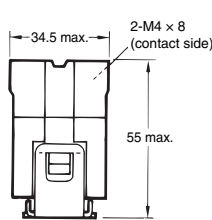
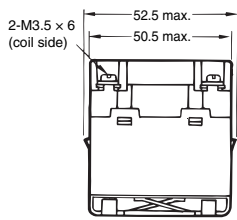
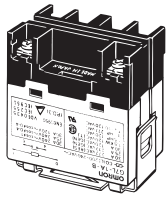

#### Terminal Arrangement/ Internal Connections (Top View)

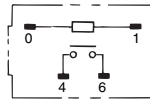

(No coil polarity)  
Note. Refer to page 12 for the coil internal connection diagram

### G7L-2A-B

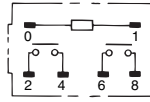
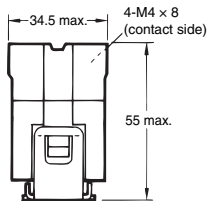
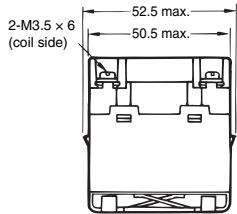
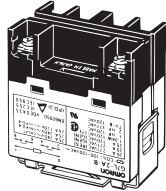

(No coil polarity)  
Note. Refer to page 12 for the coil internal connection diagram

#### Mounting Holes

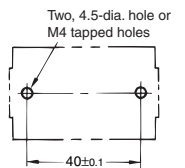

### G7L-1A-BJ (with Test Button)

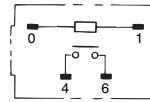
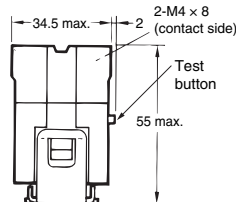
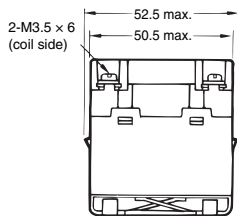
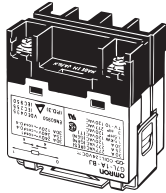

(No coil polarity)  
Note. Refer to page 12 for the coil internal connection diagram

### G7L-2A-BJ (with Test Button)

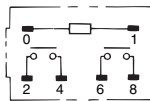
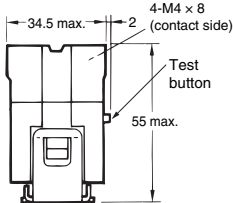
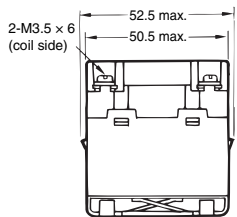
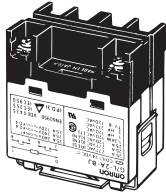

(No coil polarity)  
Note. Refer to page 12 for the coil internal connection diagram

## ● Adapter Mounting Screw Terminals

Note 1. The DIN Track Mounting Adapter and DIN tracks are sold separately.  
2. The DIN Track Mounting Adapter can be track-mounted or screw-mounted.

### G7L-1A-B

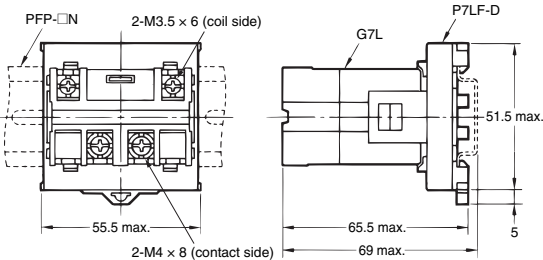
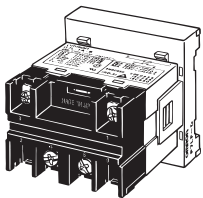

#### Terminal Arrangement/ Internal Connections (Top View)

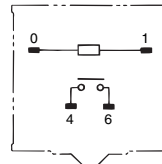

(No coil polarity)  
Note. Refer to page 12 for the coil internal connection diagram

#### Mounting Holes

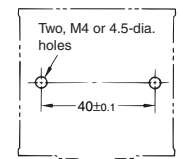

### G7L-2A-B

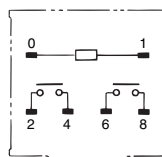
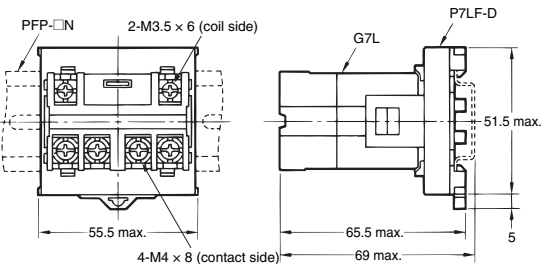
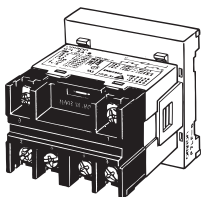

(No coil polarity)  
Note. Refer to page 12 for the coil internal connection diagram



## G7L-1A-BJ (with Test Button)

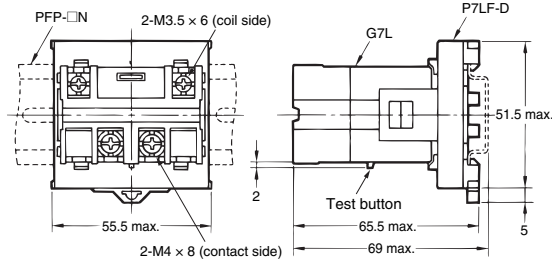
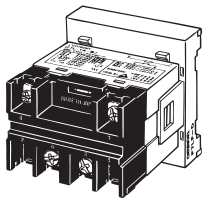

### Terminal Arrangement/ Internal Connections (Top View)

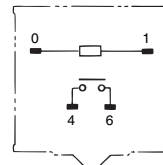

Note. Refer to page 12 for the coil internal connection diagram

### Mounting Holes

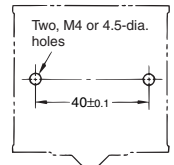

## G7L-2A-BJ (with Test Button)

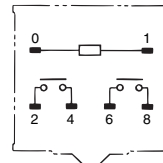
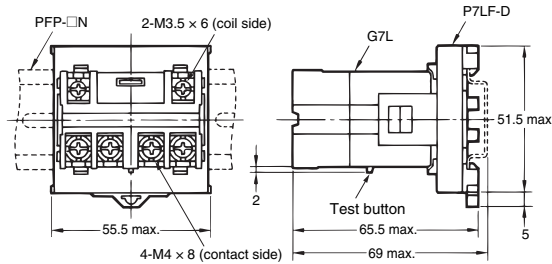
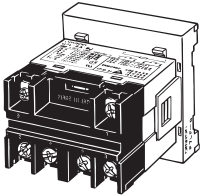

Note. Refer to page 12 for the coil internal connection diagram

## ● Upper Bracket Mounting Screw Terminals

### G7L-1A-BUB

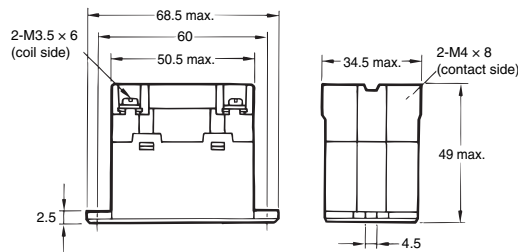
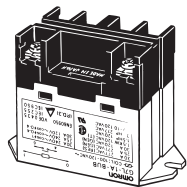

### Terminal Arrangement/ Internal Connections (Top View)

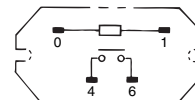

Note. Refer to page 12 for the coil internal connection diagram

### G7L-2A-BUB

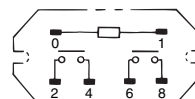
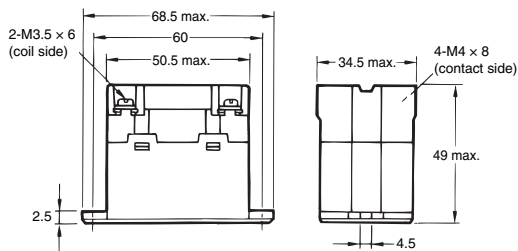
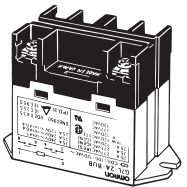

Note. Refer to page 12 for the coil internal connection diagram

### Mounting Holes

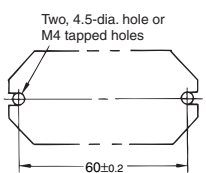

## G7L-1A-BUBJ (with Test Button)

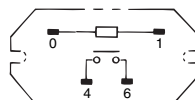
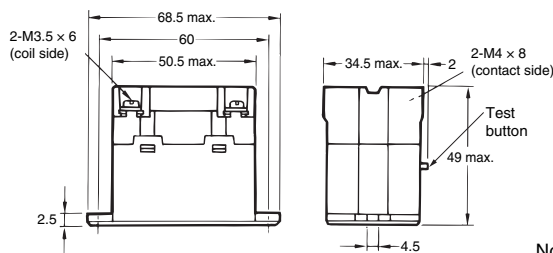
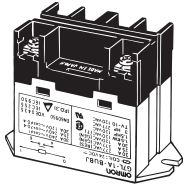

Note. Refer to page 12 for the coil internal connection diagram

## G7L-2A-BUBJ (with Test Button)

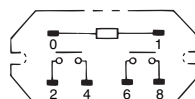
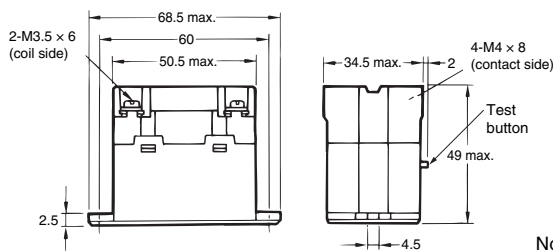
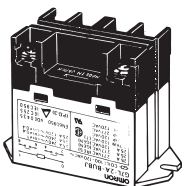

Note. Refer to page 12 for the coil internal connection diagram

## ● PCB Mounting PCB Terminals

### G7L-1A-P

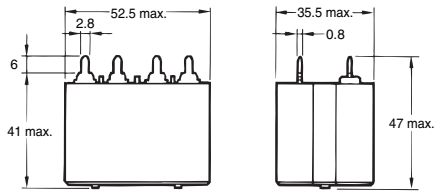
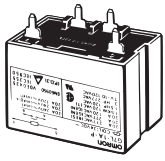

#### Terminal Arrangement/ Internal Connections (Top View)

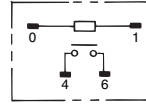

(No coil polarity)  
Note. Refer to page 12 for the coil internal connection diagram

#### PCB Mounting Holes (Bottom View)

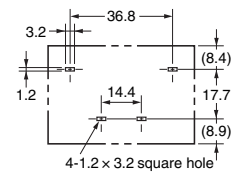

### G7L-2A-P

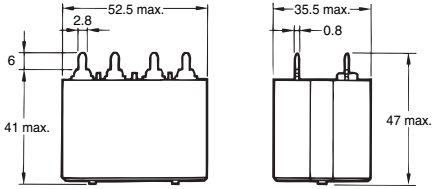
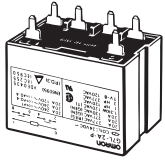

#### Terminal Arrangement/ Internal Connections (Top View)

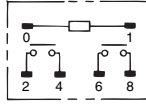

(No coil polarity)  
Note. Refer to page 12 for the coil internal connection diagram

#### PCB Mounting Holes (Bottom View)

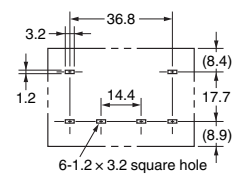

## ● E-bracket R99-07 (E KANAGU) FOR G7L

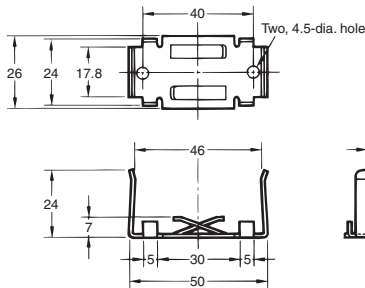
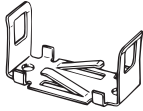

#### Mounting Holes

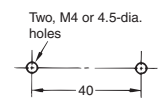

## ● Adapter P7LF-D

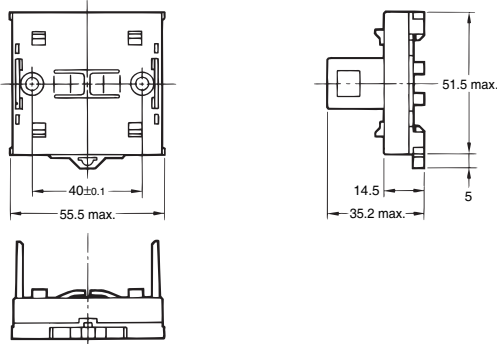
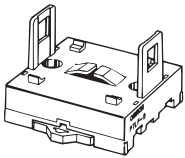

#### Mounting Holes

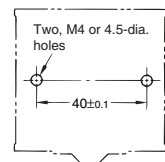

## ● Front-connecting Socket P7LF-06

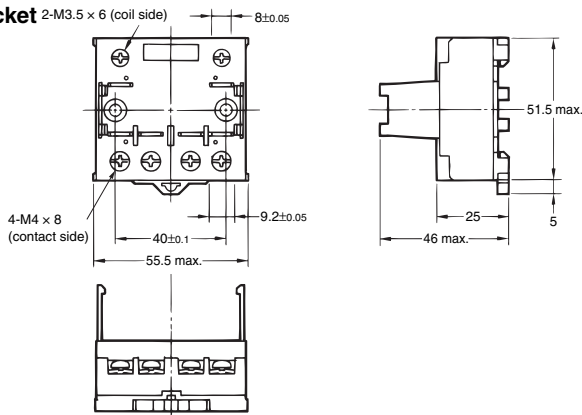
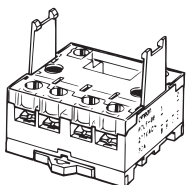

#### Mounting Holes

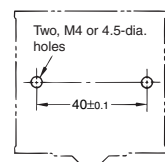

## ● Cover P7LF-C

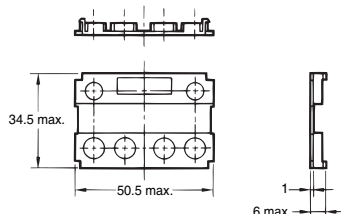
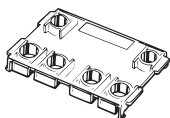

Put the P7LF-C cover onto the terminals in order to protect the user from electric shock.

## Approved Standards

· A variety of Safety Standard approved products for standard models.

**UL approval**  (File No. E41643)

Model	Coil ratings	Contact ratings	Number of test operations
		SPST-NO	
G7L-1A-T□ G7L-1A-B□ G7L-1A-P G7L-2A-T□ G7L-2A-B□ G7L-2A-P	12 to 240 VAC 6 to 220 VDC	30 A, 277 VAC (RES) 40°C	100,000
		1.5 kW, 120 VAC (T) 40°C	6,000
		1.5 HP, 120 VAC 40°C	1,000
		3 HP 277 VAC 40°C	100,000
		20 FLA/120 LRA, 120 VAC 40°C	30,000
17 FLA/102 LRA, 277 VAC 40°C			
		TV-10, 120 VAC 40°C	25,000

**CSA approval**  (File No. LR31928)

Model	Coil ratings	Contact ratings	Number of test operations
		SPST-NO	
G7L-1A-P	12 to 240 VAC 6 to 220 VDC	2.4 kW, 120 VAC (T) 40°C	6,000
		1.5 HP, 120 VAC (T) 40°C	1,000
		3 HP 277 VAC 40°C	
		20.5 FLA/105 LRA, 120 VAC 85°C	100,000
		TV-10, 120 VAC 40°C	25,000
G7L-1A-T□ G7L-1A-B□	12 to 240 VAC	30 A, 277 VAC (RES) 40°C	100,000
		2.4 kW, 120 VAC (T) 40°C	6,000
G7L-2A-T□ G7L-2A-B□ G7L-2A-P	6 to 220 VDC	1.5 HP, 120 VAC 40°C	1,000
		3 HP 277 VAC 40°C	
		20.5 FLA/105 LRA, 120 VAC 85°C	100,000
		TV-10, 120 VAC 40°C	25,000

**●Reference**

UL Approved Type .....

- UL508 Industrial Control Devices
- UL1950 Information processing equipment  
(Including office equipment)

CSA Approved Type.....

- CSA C22.2 No.1, 14  
Industrial Control Devices
- CSA C22.2 No.950 Information processing equipment  
(Including office equipment)

TÜV EN/IEC Standard Approved Type .....

- EN61810-1 Relay
- EN60950 Information processing equipment  
(Including office equipment)
- IEC950 Information processing equipment  
(Including office equipment)

**EN/IEC, TÜV Approval**  (File No. R50059083)

Model	Coil ratings	Contact ratings	Approved switching operations
		SPST-NO	
G7L-1A-B□		30 A, 250 VAC ~ (cosφ = 1) 60°C 25 A, 250 VAC ~ (cosφ = 0.4) 60°C 30 A, 120 VAC ~ (cosφ = 0.4) 60°C	50,000
		DPST-NO	
G7L-2A-B□		25 A, 277 VAC ~ (cosφ = 1) 60°C 25 A, 277 VAC ~ (cosφ = 0.4) 60°C	50,000
		SPST-NO	
G7L-1A-T□		25 A, 240 VAC ~ (cosφ = 1) 60°C 25 A, 240 VAC ~ (cosφ = 0.4) 60°C 25 A, 277 VAC ~ (cosφ = 1) 60°C 25 A, 277 VAC ~ (cosφ = 0.4) 60°C	50,000
		DPST-NO	
G7L-2A-T□	6, 12, 24, 48, 100, 110, 200, 220 VDC 12, 24, 50, 100 to 120, 200 to 240 VAC	25 A, 240 VAC ~ (cosφ = 1) 60°C 25 A, 240 VAC ~ (cosφ = 0.4) 60°C 25 A, 277 VAC ~ (cosφ = 1) 60°C 25 A, 277 VAC ~ (cosφ = 0.4) 60°C	50,000
		DPST-NO	
G7L-1A-P		20 A, 240 VAC ~ (cosφ = 1) 60°C 20 A, 240 VAC ~ (cosφ = 0.4) 60°C 25 A, 277 VAC ~ (cosφ = 1) 60°C 25 A, 277 VAC ~ (cosφ = 0.4) 60°C	50,000
		SPST-NO	
G7L-2A-P		20 A, 240 VAC ~ (cosφ = 1) 60°C 20 A, 240 VAC ~ (cosφ = 0.4) 60°C 25 A, 277 VAC ~ (cosφ = 1) 60°C 25 A, 277 VAC ~ (cosφ = 0.4) 60°C	50,000
		DPST-NO	

G  
7  
L

## ■Precautions

- Please refer to “PCB Relays Common Precautions” for general precautions.

### Correct Use

#### ● Installation

- Although there are not specific limits on the installation site, it should be as dry and dust-free as possible.
- Using in an atmosphere of high temperature, high humidity and corrosive gas may deteriorate its performance characteristic caused by condensation or corrosive products, resulting in failure or burn damage of the Relay.
- PCB Terminal-equipped Relays weigh approximately 100 g. Be sure that the PCB is strong enough to support them. We recommend dual-side through-hole PCBs to reduce solder cracking from heat stress.
- Relays with test buttons must be mounted facing down. Be careful not to touch the test button accidentally. Doing so may turn ON the contact.
- Be sure to use the test button for test purposes only (with test-button models). The test button is used for Relay circuit tests, such as circuit continuity tests. Do not attempt to switch the load with the test button.

#### ● Micro Loads

- The G7L is used for switching power loads, such as motor, transformer, solenoid, lamp, and heater loads. Do not use the G7L for switching micro loads, such as signals.

#### ● Soldering PCB Terminals

- Do not perform automatic soldering but solder manually.
- Do not wash down the entire Relay because it does not have an airtight construction.

#### ● Connecting

- Refer to the following table when connecting a wire with a crimpstyle terminal to the G7L.

	Screw terminals	Front-connecting Socket
Coil		
Contact		

- Allow suitable slack on leads when wiring, and do not apply excessive force to the terminals.
- Tightening torque  
Coil: 0.78 to 1.18 N · m  
Contact: 0.98 to 1.37 N · m

Type	Receptacle terminals*	Positive housing
#250 terminals (width: 6.35 mm)	AMP 170333-1 (170327-1) AMP 170334-1 (170328-1) AMP 170335-1 (170329-1)	AMP 172076-1 natural color AMP 172076-4 yellow AMP 172076-5 green AMP 172076-6 blue

\* The numbers shown in parentheses are for air-feeding.

Note 1. The current should be 25 A when using receptacle terminals.

Note 2. Use receptacle terminals or positive housing for cable wiring.

#### ● Reference Data

- The ratio of rated voltage between 100 to 120 VAC are values measured on the basis of 100 VAC.

#### ● Operating Coil

(Coil internal connections diagram)

- DC Coil

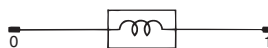

- AC Coil

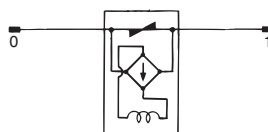

- If a transistor drives the G7L check the leakage current, and connect a bleeder resistor if necessary.
- The AC coil is provided with a built-in full-wave rectifier. If a triac, such as an SSR, drives the G7L, the G7L may not release. Be sure to perform a trial operation with the G7L and the triac before applying them to actual use.

When connecting with screws, if the screws are not sufficiently tightened, the lead wire can become detached and may lead to abnormal heating or fire caused by faulty contact.

- Mounting Torque  
0.98N · m  
Tighten with two M4 screws when mounting.  
(Top bracket type)
- Do not apply excessive force when mounting or dismounting the Faston receptacle. Insert and remove terminals carefully one at a time. Do not insert terminals at an angle, or insert/remove multiple terminals at the same time.
- Do not connect to the terminals by soldering

#### ● DIN Track Mounting Adapter and Front-connecting Socket

(DIN Track Mounting)

- The DIN Track Mounting Adapter and Front-connecting Socket can be mounted on the G7L with just one hand and dismantled with ease by using a screwdriver.
- To support the G7L mounted on a DIN Track Mounting Adapter or Front-connecting Socket, use the PFP-M End Plate. Put the End Plate onto the DIN Track Mounting Adapter or Front-connecting Socket so that the surface mark of the End Plate faces upwards. Then tighten the screw of the End Plate securely with a screwdriver.

(Screw Mounting)

- Screw-mount the DIN Track Mounting Adapter or Front-connecting Socket securely after opening screw mounting holes on them.
- When cutting or opening holes on the panel after the Front-connecting Socket is mounted, take proper measures so that the cutting chips will not fall onto the Relay terminals. When cutting or opening holes on the upper part of the panel, mask the Front-connecting Socket properly with a cover.

- Application examples provided in this document are for reference only. In actual applications, confirm equipment functions and safety before using the product.
- Consult your OMRON representative before using the product under conditions which are not described in the manual or applying the product to nuclear control systems, railroad systems, aviation systems, vehicles, combustion systems, medical equipment, amusement machines, safety equipment, and other systems or equipment that may have a serious influence on lives and property if used improperly. Make sure that the ratings and performance characteristics of the product provide a margin of safety for the system or equipment, and be sure to provide the system or equipment with double safety mechanisms.

**Note: Do not use this document to operate the Unit.**