



RF Power Field Effect Transistor

N-Channel Enhancement-Mode Lateral MOSFET

Designed for CDMA base station applications with frequencies from 2300 to 2400 MHz. Suitable for WiMAX, WiBro and multicarrier amplifier applications. To be used in Class AB and Class C for WLL applications.

- Typical 2-Carrier W-CDMA Performance: $V_{DD} = 28$ Volts, $I_{DQ} = 1900$ mA, $P_{out} = 40$ Watts Avg., $f = 2390$ MHz, Channel Bandwidth = 3.84 MHz, PAR = 8.5 dB @ 0.01% Probability on CCDF.
 Power Gain — 14 dB
 Drain Efficiency — 23.5%
 IM3 @ 10 MHz Offset — -37.5 dBc in 3.84 MHz Channel Bandwidth
 ACPR @ 5 MHz Offset — -41 dBc in 3.84 MHz Channel Bandwidth
- Capable of Handling 10:1 VSWR, @ 28 Vdc, 2340 MHz, 190 Watts CW Output Power

Features

- Characterized with Series Equivalent Large-Signal Impedance Parameters
- Internally Matched for Ease of Use
- Qualified Up to a Maximum of 32 V_{DD} Operation
- Integrated ESD Protection
- Designed for Lower Memory Effects and Wide Instantaneous Bandwidth Applications
- RoHS Compliant
- In Tape and Reel. R6 Suffix = 150 Units per 56 mm, 13 inch Reel.

MRF6P23190HR6

**2300-2400 MHz, 40 W AVG., 28 V
 2 x W-CDMA
 LATERAL N-CHANNEL
 RF POWER MOSFET**

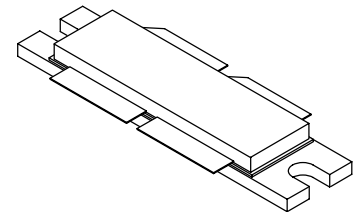

**CASE 375D-05, STYLE 1
 NI-1230**

Table 1. Maximum Ratings

Rating	Symbol	Value	Unit
Drain-Source Voltage	V_{DSS}	-0.5, +68	Vdc
Gate-Source Voltage	V_{GS}	-0.5, +12	Vdc
Storage Temperature Range	T_{stg}	- 65 to +150	°C
Case Operating Temperature	T_C	150	°C
Operating Junction Temperature (1,2)	T_J	225	°C
CW Operation @ $T_C = 25^\circ\text{C}$ Derate above 25°C	CW	250 1.3	W W/°C

Table 2. Thermal Characteristics

Characteristic	Symbol	Value (2,3)	Unit
Thermal Resistance, Junction to Case Case Temperature 100°C, 160 W CW Case Temperature 83°C, 40 W CW	$R_{\theta JC}$	0.22 0.24	°C/W

1. Continuous use at maximum temperature will affect MTTF.
2. MTTF calculator available at <http://www.freescale.com/rf>. Select Software & Tools/Development Tools/Calculators to access MTTF calculators by product.
3. Refer to AN1955, *Thermal Measurement Methodology of RF Power Amplifiers*. Go to <http://www.freescale.com/rf>. Select Documentation/Application Notes - AN1955.

Table 3. ESD Protection Characteristics

Test Methodology	Class
Human Body Model (per JESD22-A114)	1C (Minimum)
Machine Model (per EIA/JESD22-A115)	A (Minimum)
Charge Device Model (per JESD22-C101)	III (Minimum)

Table 4. Electrical Characteristics ($T_C = 25^\circ\text{C}$ unless otherwise noted)

Characteristic	Symbol	Min	Typ	Max	Unit
Off Characteristics ⁽¹⁾					
Zero Gate Voltage Drain Leakage Current ($V_{DS} = 68\text{ Vdc}$, $V_{GS} = 0\text{ Vdc}$)	I_{DSS}	—	—	10	μA
Zero Gate Voltage Drain Leakage Current ($V_{DS} = 28\text{ Vdc}$, $V_{GS} = 0\text{ Vdc}$)	I_{DSS}	—	—	1	μA
Gate-Source Leakage Current ($V_{GS} = 5\text{ Vdc}$, $V_{DS} = 0\text{ Vdc}$)	I_{GSS}	—	—	1	μA

On Characteristics

Gate Threshold Voltage ⁽¹⁾ ($V_{DS} = 10\text{ Vdc}$, $I_D = 200\ \mu\text{A}$)	$V_{GS(th)}$	1	2	3	Vdc
Gate Quiescent Voltage ⁽³⁾ ($V_{DD} = 28\text{ Vdc}$, $I_D = 1900\text{ mA}$, Measured in Functional Test)	$V_{GS(Q)}$	2	2.8	4	Vdc
Drain-Source On-Voltage ⁽¹⁾ ($V_{GS} = 10\text{ Vdc}$, $I_D = 2.2\text{ A}$)	$V_{DS(on)}$	0.1	0.21	0.3	Vdc

Dynamic Characteristics ^(1,2)

Reverse Transfer Capacitance ($V_{DS} = 28\text{ Vdc} \pm 30\text{ mV(rms)}$ ac @ 1 MHz, $V_{GS} = 0\text{ Vdc}$)	C_{rss}	—	1.5	—	pF
--	-----------	---	-----	---	----

Functional Tests ⁽³⁾ (In Freescale Test Fixture, 50 ohm system) $V_{DD} = 28\text{ Vdc}$, $I_{DQ} = 1900\text{ mA}$, $P_{out} = 40\text{ W Avg.}$, $f = 2390\text{ MHz}$, 2-Carrier W-CDMA, 3.84 MHz Channel Bandwidth Carriers. ACPR measured in 3.84 MHz Channel Bandwidth @ $\pm 5\text{ MHz}$ Offset. IM3 measured in 3.84 MHz Bandwidth @ $\pm 10\text{ MHz}$ Offset. PAR = 8.5 dB @ 0.01% Probability on CCDF.

Power Gain	G_{ps}	13	14	16	dB
Drain Efficiency	η_D	22	23.5	—	%
Intermodulation Distortion	IM3	—	-37.5	-35	dBc
Adjacent Channel Power Ratio	ACPR	—	-41	-38	dBc
Input Return Loss	IRL	—	-13	—	dB

1. Each side of device measured separately.
2. Part internally matched both on input and output.
3. Measurement made with device in push-pull configuration.

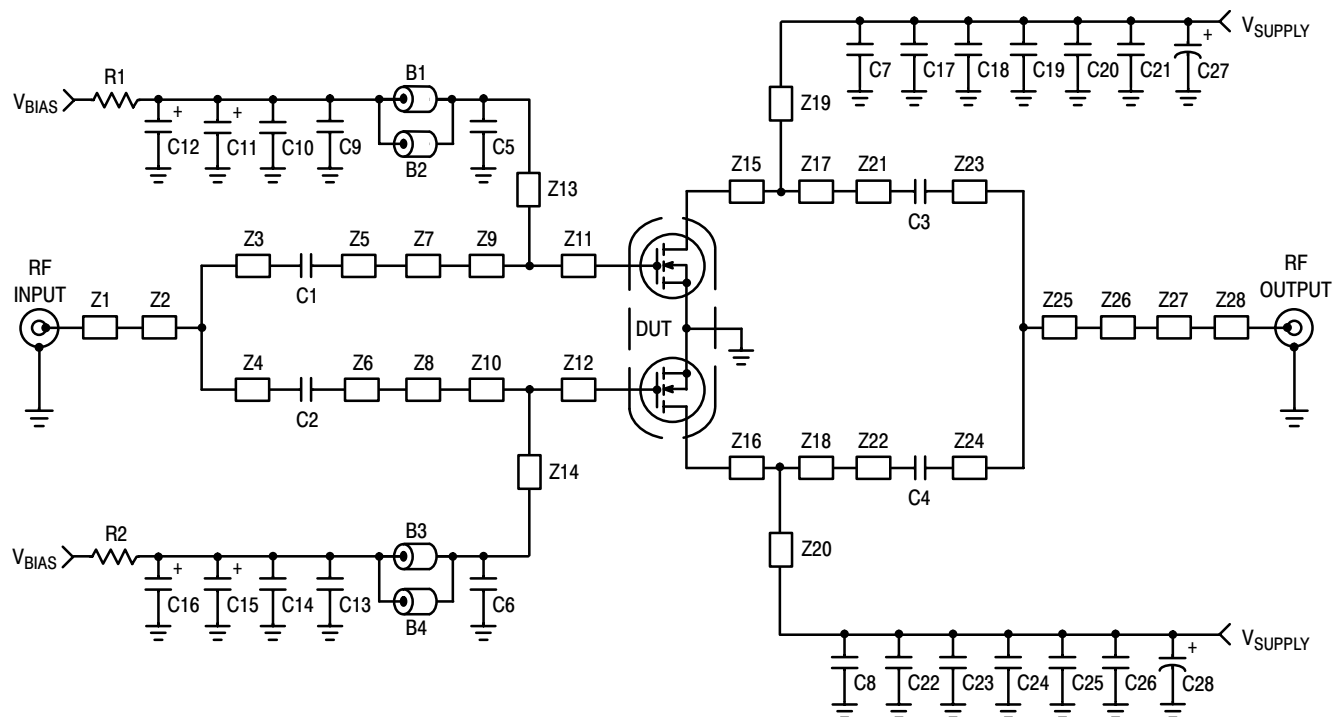

Z1, Z28	0.380" x 0.081" Microstrip
Z2	0.850" x 0.135" Microstrip
Z3	2.244" x 0.081" Microstrip
Z4	0.186" x 0.074" Microstrip
Z5, Z6	0.614" x 0.081" Microstrip
Z7, Z8	0.570" x 0.282" Microstrip
Z9, Z10	0.072" x 0.500" Microstrip
Z11, Z12	0.078" x 0.500" Microstrip
Z13, Z14	0.861" x 0.050" Microstrip
Z15, Z16	0.187" x 0.782" Microstrip

Z17, Z18	0.321" x 0.782" Microstrip
Z19, Z20	0.404" x 0.074" Microstrip
Z21, Z22	0.918" x 0.081" Microstrip
Z23	0.346" x 0.081" Microstrip
Z24	2.103" x 0.081" Microstrip
Z25	0.037" x 0.135" Microstrip
Z26	0.250" x 0.300" Microstrip
Z27	0.563" x 0.135" Microstrip
PCB	Arlon CuClad 250GX-0300-55-22, 0.030", $\epsilon_r = 2.55$

Figure 1. MRF6P23190HR6 Test Circuit Schematic

Table 5. MRF6P23190HR6 Test Circuit Component Designations and Values

Part	Description	Part Number	Manufacturer
B1, B2, B3, B4	Ferrite Beads	2508051107Y0	Fair-Rite
C1, C2, C3, C4	5.1 pF Chip Capacitors	ATC100B5R1CT500XT	ATC
C5, C6, C7, C8	5.6 pF Chip Capacitors	ATC100B5R6CT500XT	ATC
C9, C13	0.01 μ F, 100 V Chip Capacitors	C1825C103J1RAC	Kemet
C10, C14, C17, C22	2.2 μ F, 50 V Chip Capacitors	C1825C225J5RAC	Kemet
C11, C15	22 μ F, 25 V Tantalum Capacitors	T491D226K025AT	Kemet
C12, C16	47 μ F, 16 V Tantalum Capacitors	T491D476K016AT	Kemet
C18, C19, C20, C21, C23, C24, C25, C26	10 μ F, 50 V Chip Capacitors	GRM55DR61H106KA88B	Murata
C27, C28	330 μ F, 63 V Electrolytic Capacitors	NACZF331M63V	Nippon
R1, R2	240 Ω , 1/4 W Chip Resistors	CRCW12062400FKEA	Vishay

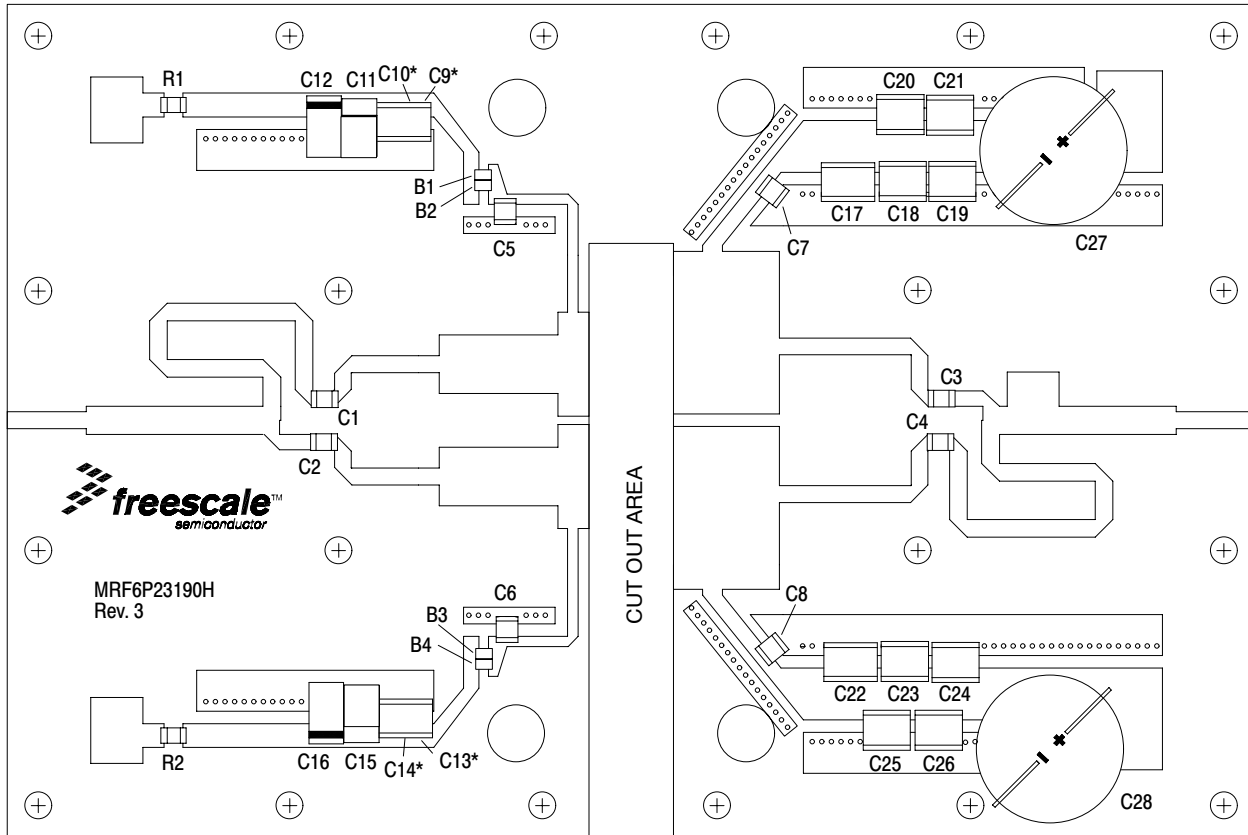

*Stacked.

Figure 2. MRF6P23190HR6 Test Circuit Component Layout

TYPICAL CHARACTERISTICS

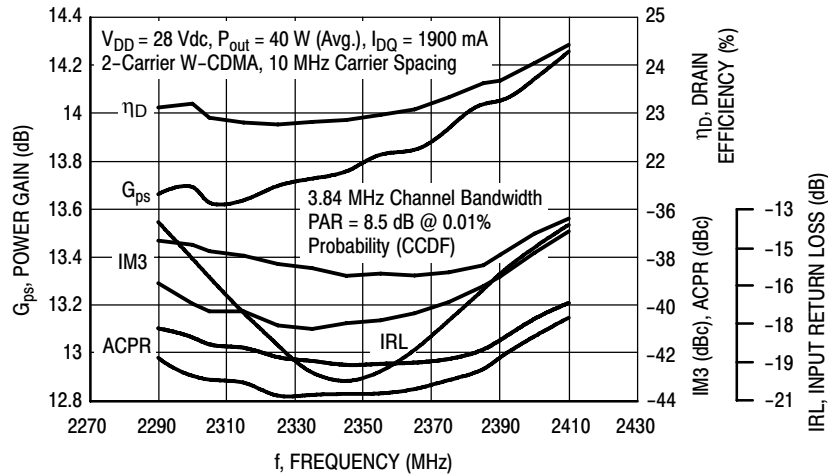

Figure 3. 2-Carrier W-CDMA Broadband Performance @ $P_{out} = 40$ Watts Avg.

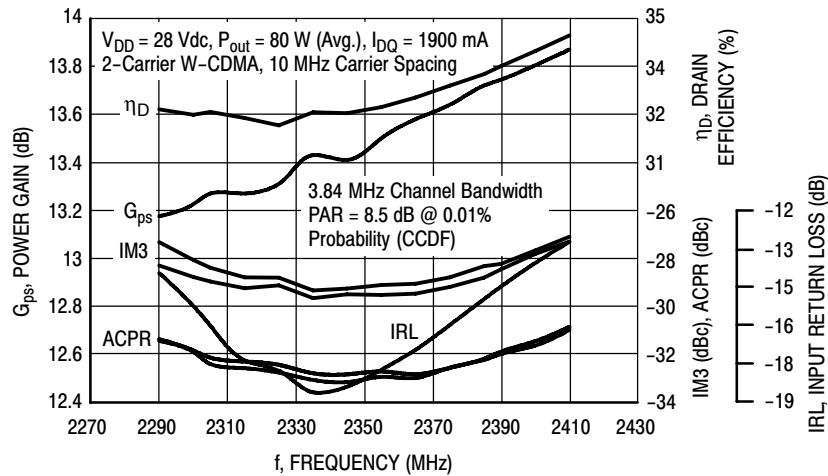

Figure 4. 2-Carrier W-CDMA Broadband Performance @ $P_{out} = 80$ Watts Avg.

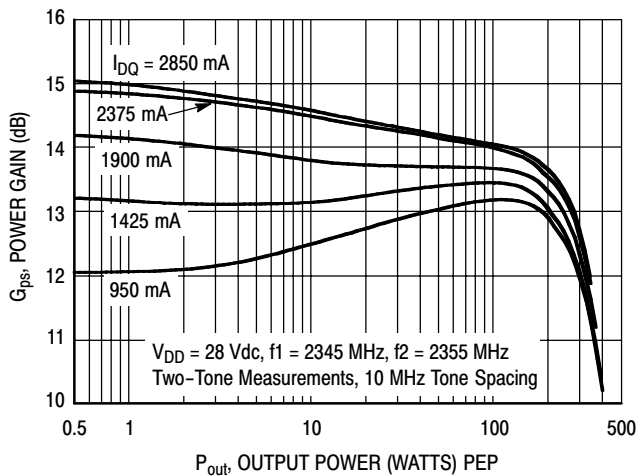

Figure 5. Two-Tone Power Gain versus Output Power

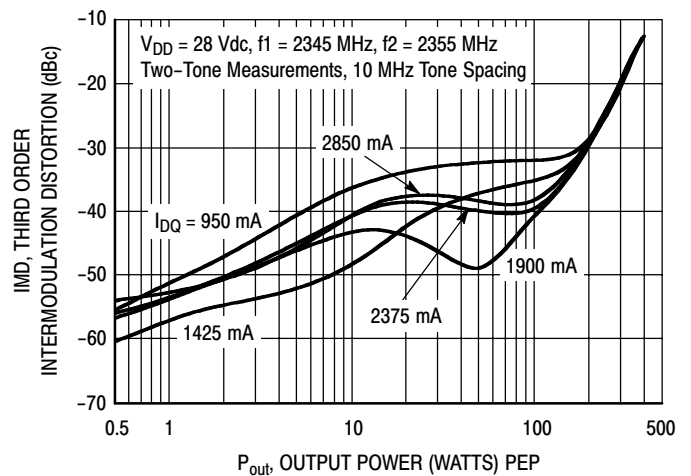

Figure 6. Third Order Intermodulation Distortion versus Output Power

TYPICAL CHARACTERISTICS

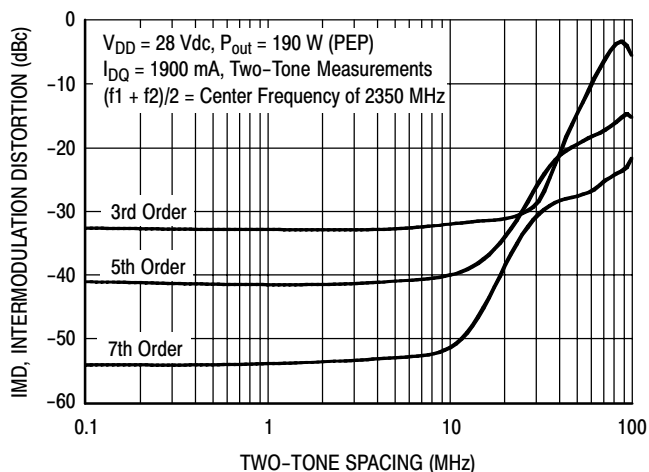

Figure 7. Intermodulation Distortion Products versus Tone Spacing

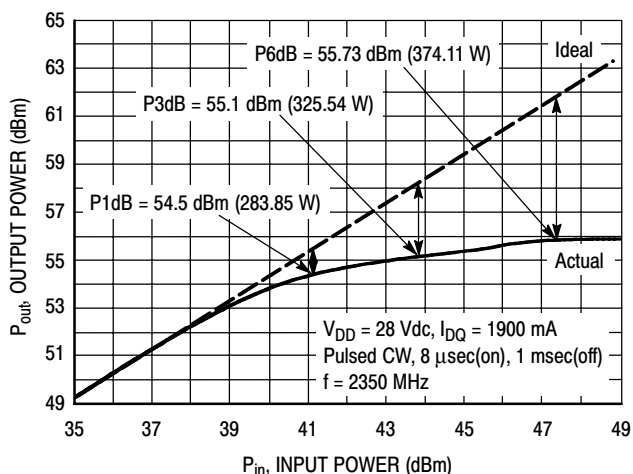

Figure 8. Pulsed CW Output Power versus Input Power

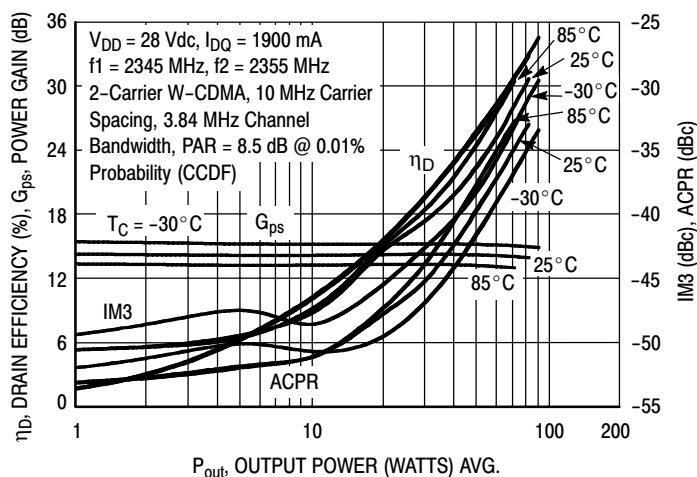

Figure 9. 2-Carrier W-CDMA ACPR, IM3, Power Gain and Drain Efficiency versus Output Power

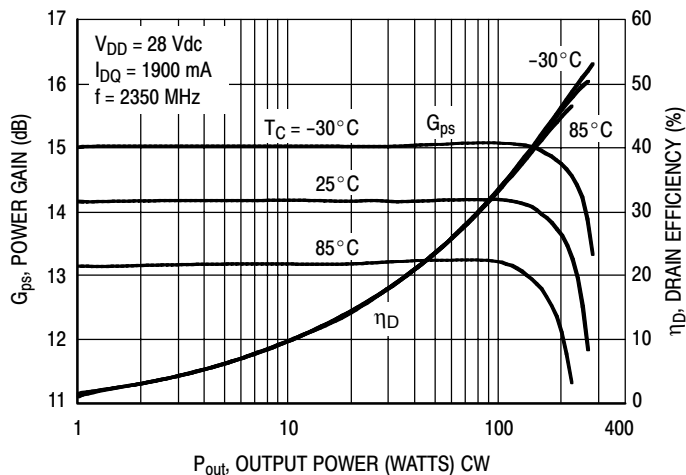

Figure 10. Power Gain and Drain Efficiency versus CW Output Power

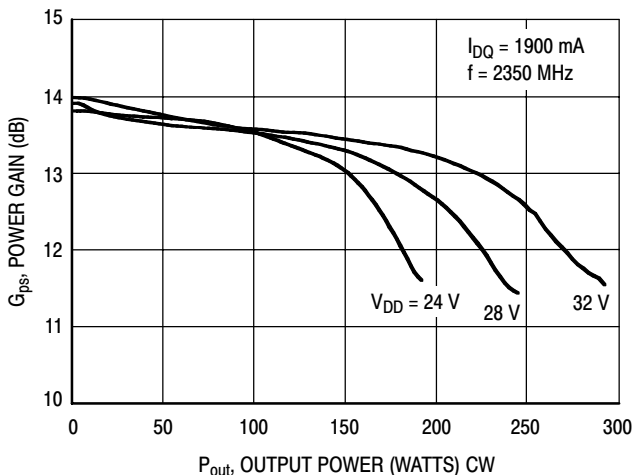
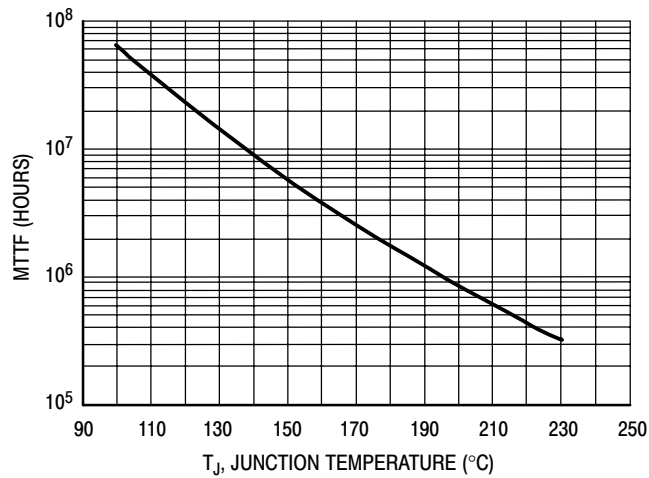

Figure 11. Power Gain versus Output Power

TYPICAL CHARACTERISTICS



This above graph displays calculated MTTF in hours when the device is operated at $V_{DD} = 28$ Vdc, $P_{out} = 40$ W Avg., and $\eta_D = 23.5\%$.

MTTF calculator available at <http://www.freescale.com/rf>. Select Software & Tools/Development Tools/Calculators to access MTTF calculators by product.

Figure 12. MTTF versus Junction Temperature

W-CDMA TEST SIGNAL

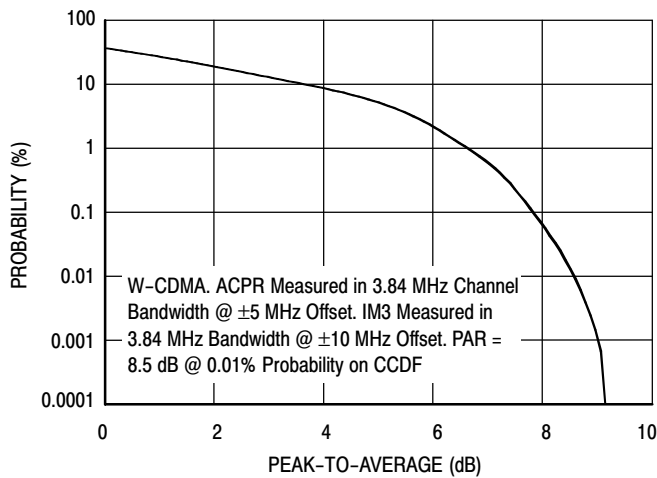

Figure 13. CCDF W-CDMA 3GPP, Test Model 1, 64 DPCH, 67% Clipping, Single-Carrier Test Signal

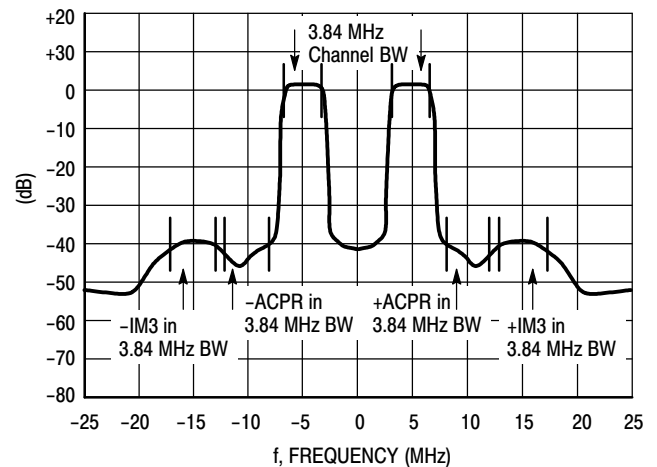
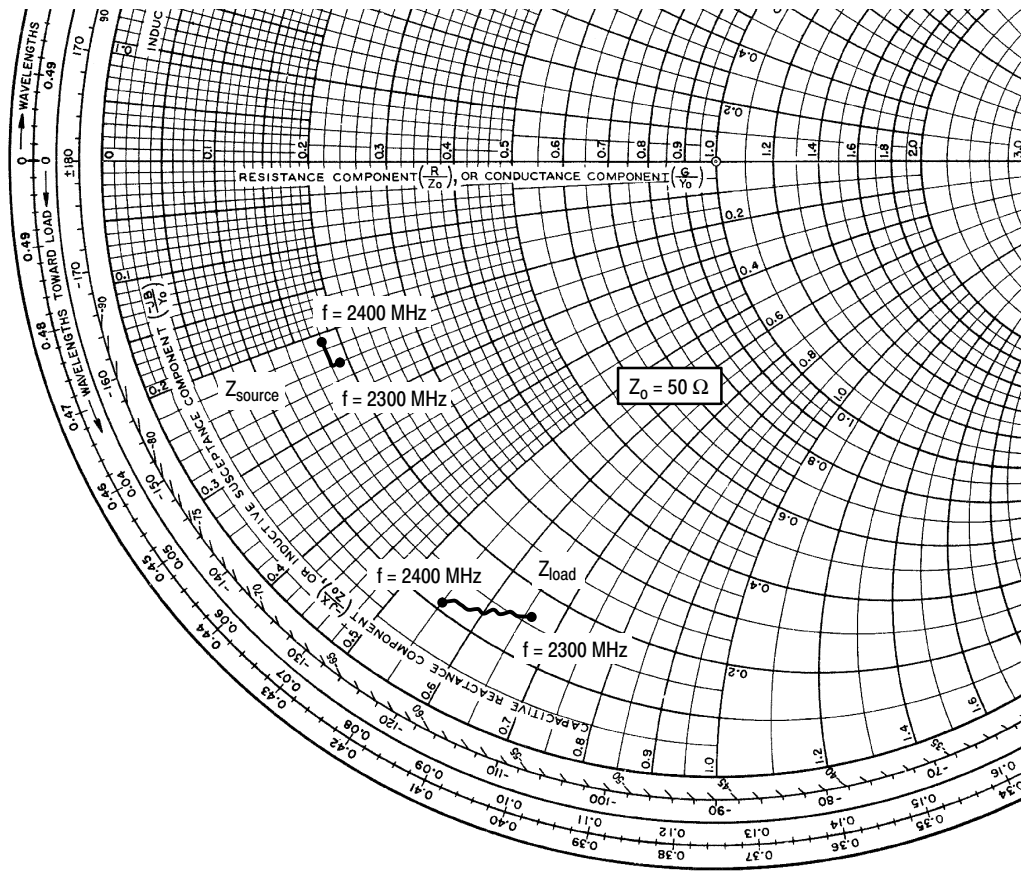

Figure 14. 2-Carrier W-CDMA Spectrum



$V_{DD} = 28 \text{ Vdc}$, $I_{DQ} = 1900 \text{ mA}$, $P_{out} = 40 \text{ W Avg.}$

f MHz	Z_{source} Ω	Z_{load} Ω
2300	9.31 - j12.12	7.89 - j32.78
2310	9.27 - j11.93	7.61 - j32.19
2320	9.24 - j11.75	7.35 - j31.62
2330	9.21 - j11.57	7.10 - j31.06
2340	9.18 - j11.40	6.86 - j30.53
2350	9.16 - j11.23	6.64 - j30.01
2360	9.14 - j11.06	6.43 - j29.51
2370	9.13 - j10.90	6.23 - j29.02
2380	9.12 - j10.75	6.04 - j28.55
2390	9.11 - j10.59	5.86 - j28.09
2400	9.11 - j10.45	5.68 - j27.64

Z_{source} = Test circuit impedance as measured from gate to gate, balanced configuration.

Z_{load} = Test circuit impedance as measured from drain to drain, balanced configuration.

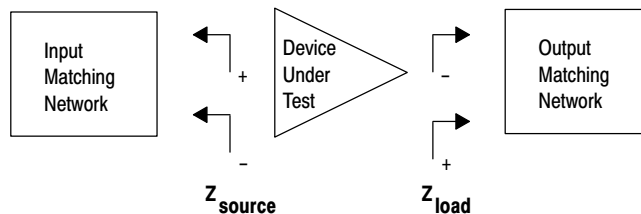
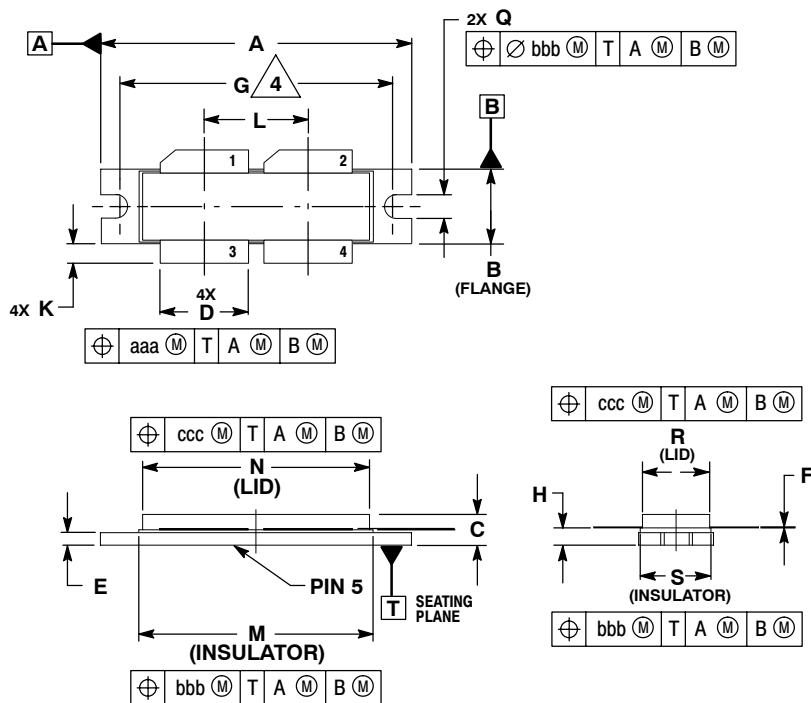

Figure 15. Series Equivalent Source and Load Impedance

PACKAGE DIMENSIONS



- NOTES:
1. INTERPRET DIMENSIONS AND TOLERANCES PER ASME Y14.5M-1994.
 2. CONTROLLING DIMENSION: INCH.
 3. DIMENSION H IS MEASURED 0.030 (0.762) AWAY FROM PACKAGE BODY.
 4. RECOMMENDED BOLT CENTER DIMENSION OF 1.52 (38.61) BASED ON M3 SCREW.

DIM	INCHES		MILLIMETERS	
	MIN	MAX	MIN	MAX
A	1.615	1.625	41.02	41.28
B	0.395	0.405	10.03	10.29
C	0.150	0.200	3.81	5.08
D	0.455	0.465	11.56	11.81
E	0.062	0.066	1.57	1.68
F	0.004	0.007	0.10	0.18
G	1.400 BSC		35.56 BSC	
H	0.082	0.090	2.08	2.29
K	0.117	0.137	2.97	3.48
L	0.540 BSC		13.72 BSC	
M	1.219	1.241	30.96	31.52
N	1.218	1.242	30.94	31.55
Q	0.120	0.130	3.05	3.30
R	0.355	0.365	9.01	9.27
S	0.365	0.375	9.27	9.53
aaa	0.013 REF		0.33 REF	
bbb	0.010 REF		0.25 REF	
ccc	0.020 REF		0.51 REF	

- STYLE 1:
 PIN 1. DRAIN
 2. DRAIN
 3. GATE
 4. GATE
 5. SOURCE

**CASE 375D-05
 ISSUE E
 NI-1230**

PRODUCT DOCUMENTATION

Refer to the following documents to aid your design process.

Application Notes

- AN1955: Thermal Measurement Methodology of RF Power Amplifiers

Engineering Bulletins

- EB212: Using Data Sheet Impedances for RF LDMOS Devices

REVISION HISTORY

The following table summarizes revisions to this document.

Revision	Date	Description
2	Mar. 2007	<ul style="list-style-type: none">• Removed Lower Thermal Resistance and Low Gold Plating bullets from Features section as functionality is standard, p. 1• Removed Total Device Dissipation from Max Ratings table as data was redundant (information already provided in Thermal Characteristics table), p. 1• Added maximum CW operation limitation and derating values to the Maximum Rating table to prevent a 200°C+ hot wire operating condition, p. 1• Corrected V_{DS} to V_{DD} in the RF test condition voltage callout for $V_{GS(Q)}$, On Characteristics table, p. 2• Removed Forward Transconductance from On Characteristics table as it no longer provided usable information, p. 2• Updated Part Numbers in Table 5, Component Designations and Values, to RoHS compliant part numbers, p. 3• Removed lower voltage tests from Fig. 11, Power Gain versus Output Power, due to fixed tuned fixture limitations, p. 6• Replaced Fig. 12, MTTF versus Junction Temperature with updated graph. Removed Amps² and listed operating characteristics and location of MTTF calculator for device, p. 7• Added Product Documentation and Revision History, p. 10
3	Dec. 2008	<ul style="list-style-type: none">• Modified data sheet to reflect RF Test Reduction described in Product and Process Change Notification number, PCN13232, p. 1, 2• Operating Junction Temperature increased from 200°C to 225°C in Maximum Ratings table, related “Continuous use at maximum temperature will affect MTTF” footnote added, p. 1• Updated PCB information to show more specific material details, Fig. 1, Test Circuit Schematic, p. 3• Updated Part Numbers in Table 5, Component Designations and Values, to latest RoHS compliant part numbers, p. 3

How to Reach Us:

Home Page:

www.freescale.com

Web Support:

<http://www.freescale.com/support>

USA/Europe or Locations Not Listed:

Freescale Semiconductor, Inc.
Technical Information Center, EL516
2100 East Elliot Road
Tempe, Arizona 85284
1-800-521-6274 or +1-480-768-2130
www.freescale.com/support

Europe, Middle East, and Africa:

Freescale Halbleiter Deutschland GmbH
Technical Information Center
Schatzbogen 7
81829 Muenchen, Germany
+44 1296 380 456 (English)
+46 8 52200080 (English)
+49 89 92103 559 (German)
+33 1 69 35 48 48 (French)
www.freescale.com/support

Japan:

Freescale Semiconductor Japan Ltd.
Headquarters
ARCO Tower 15F
1-8-1, Shimo-Meguro, Meguro-ku,
Tokyo 153-0064
Japan
0120 191014 or +81 3 5437 9125
support.japan@freescale.com

Asia/Pacific:

Freescale Semiconductor China Ltd.
Exchange Building 23F
No. 118 Jianguo Road
Chaoyang District
Beijing 100022
China
+86 10 5879 8000
support.asia@freescale.com

For Literature Requests Only:

Freescale Semiconductor Literature Distribution Center
P.O. Box 5405
Denver, Colorado 80217
1-800-441-2447 or +1-303-675-2140
Fax: +1-303-675-2150
LDCForFreescaleSemiconductor@hibbertgroup.com

Information in this document is provided solely to enable system and software implementers to use Freescale Semiconductor products. There are no express or implied copyright licenses granted hereunder to design or fabricate any integrated circuits or integrated circuits based on the information in this document.

Freescale Semiconductor reserves the right to make changes without further notice to any products herein. Freescale Semiconductor makes no warranty, representation or guarantee regarding the suitability of its products for any particular purpose, nor does Freescale Semiconductor assume any liability arising out of the application or use of any product or circuit, and specifically disclaims any and all liability, including without limitation consequential or incidental damages. "Typical" parameters that may be provided in Freescale Semiconductor data sheets and/or specifications can and do vary in different applications and actual performance may vary over time. All operating parameters, including "Typicals", must be validated for each customer application by customer's technical experts. Freescale Semiconductor does not convey any license under its patent rights nor the rights of others. Freescale Semiconductor products are not designed, intended, or authorized for use as components in systems intended for surgical implant into the body, or other applications intended to support or sustain life, or for any other application in which the failure of the Freescale Semiconductor product could create a situation where personal injury or death may occur. Should Buyer purchase or use Freescale Semiconductor products for any such unintended or unauthorized application, Buyer shall indemnify and hold Freescale Semiconductor and its officers, employees, subsidiaries, affiliates, and distributors harmless against all claims, costs, damages, and expenses, and reasonable attorney fees arising out of, directly or indirectly, any claim of personal injury or death associated with such unintended or unauthorized use, even if such claim alleges that Freescale Semiconductor was negligent regarding the design or manufacture of the part.

Freescale™ and the Freescale logo are trademarks of Freescale Semiconductor, Inc. All other product or service names are the property of their respective owners.

© Freescale Semiconductor, Inc. 2005-2008. All rights reserved.

