

EMK33H2H-32.768M TR

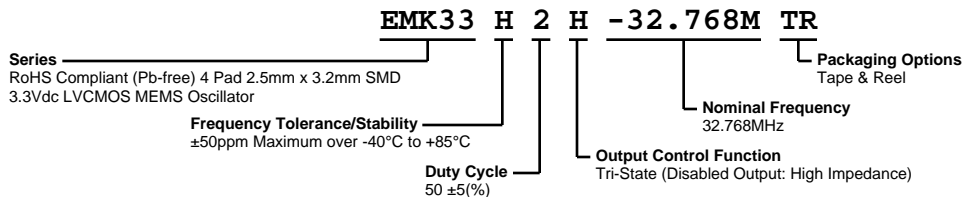

ECLIPTEK
CORPORATION



ELECTRICAL SPECIFICATIONS

Nominal Frequency	32.768MHz
Frequency Tolerance/Stability	±50ppm Maximum over -40°C to +85°C (Inclusive of all conditions: Calibration Tolerance at 25°C, Frequency Stability over the Operating Temperature Range, Supply Voltage Change, Output Load Change, First Year Aging at 25°C, 260°C Reflow, Shock, and Vibration)
Aging at 25°C	±1ppm Maximum First Year
Operating Temperature Range	-40°C to +85°C
Supply Voltage	3.3Vdc ±10%
Input Current	25mA Maximum
Output Voltage Logic High (Voh)	90% of Vdd Minimum (IOH=-8mA)
Output Voltage Logic Low (Vol)	10% of Vdd Maximum (IOL=+8mA)
Rise/Fall Time	2nSec Maximum (Measured from 20% to 80% of waveform)
Duty Cycle	50 ±5(%) (Measured at 50% of waveform)
Load Drive Capability	15pF Maximum
Output Logic Type	CMOS
Output Control Function	Tri-State (Disabled Output: High Impedance)
Output Control Input Voltage	+0.7Vdd Minimum or No Connect to Enable Output, +0.3Vdd Maximum to Disable Output
Peak to Peak Jitter (tPK)	250pSec Maximum, 100pSec Typical
Start Up Time	50mSec Maximum
Storage Temperature Range	-55°C to +125°C

ENVIRONMENTAL & MECHANICAL SPECIFICATIONS

ESD Susceptibility	MIL-STD-883, Method 3015, Class 2, HBM 2000V
Flammability	UL94-V0
Mechanical Shock	MIL-STD-883, Method 2002, Condition G, 30,000G
Moisture Resistance	MIL-STD-883, Method 1004
Moisture Sensitivity Level	J-STD-020, MSL 1
Resistance to Soldering Heat	MIL-STD-202, Method 210, Condition K
Resistance to Solvents	MIL-STD-202, Method 215
Solderability	MIL-STD-883, Method 2003 (Pads on Bottom of Package Only)
Temperature Cycling	MIL-STD-883, Method 1010, Condition B
Thermal Shock	MIL-STD-883, Method 1011, Condition B
Vibration	MIL-STD-883, Method 2007, Condition A, 20G

EMK33H2H-32.768M TR

MECHANICAL DIMENSIONS (all dimensions in millimeters)



PIN	CONNECTION
1	Tri-State
2	Ground
3	Output
4	Supply Voltage

LINE	MARKING
1	XXXX XXXX=Ecliptek Manufacturing Lot Code

Suggested Solder Pad Layout

All Dimensions in Millimeters



All Tolerances are ± 0.1

EMK33H2H-32.768M TR

OUTPUT WAVEFORM & TIMING DIAGRAM



Test Circuit for CMOS Output

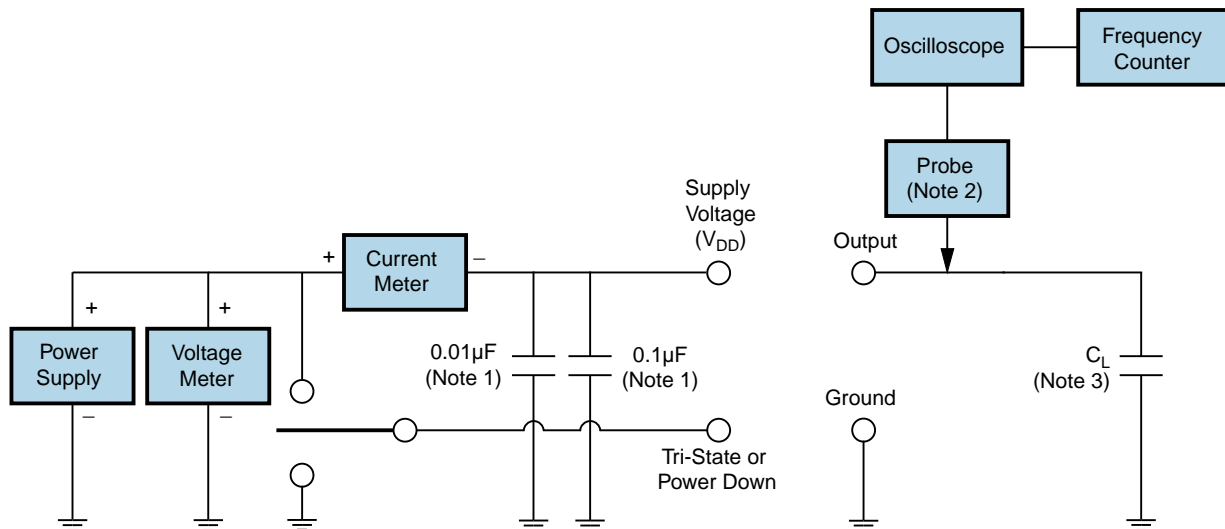

Note 1: An external 0.1µF low frequency tantalum bypass capacitor in parallel with a 0.01µF high frequency ceramic bypass capacitor close to the package ground and V_{DD} pin is required.

Note 2: A low capacitance (<12pF), 10X attenuation factor, high impedance (>10Mohms), and high bandwidth (>300MHz) passive probe is recommended.

Note 3: Capacitance value C_L includes sum of all probe and fixture capacitance.

EMK33H2H-32.768M TR

Tape & Reel Dimensions

Quantity Per Reel: 1,000 units



*Compliant to EIA 481A



Recommended Solder Reflow Methods



High Temperature Infrared/Convection

T_s MAX to T_L (Ramp-up Rate)	3°C/second Maximum
Preheat	
- Temperature Minimum (T_s MIN)	150°C
- Temperature Typical (T_s TYP)	175°C
- Temperature Maximum (T_s MAX)	200°C
- Time (t_s MIN)	60 - 180 Seconds
Ramp-up Rate (T_L to T_p)	3°C/second Maximum
Time Maintained Above:	
- Temperature (T_L)	217°C
- Time (t_L)	60 - 150 Seconds
Peak Temperature (T_p)	260°C Maximum for 10 Seconds Maximum
Target Peak Temperature (T_p Target)	250°C +0/-5°C
Time within 5°C of actual peak (t_p)	20 - 40 seconds
Ramp-down Rate	6°C/second Maximum
Time 25°C to Peak Temperature (t)	8 minutes Maximum
Moisture Sensitivity Level	Level 1

Recommended Solder Reflow Methods



Low Temperature Infrared/Convection 240°C

T_s MAX to T_L (Ramp-up Rate)	5°C/second Maximum
Preheat	
- Temperature Minimum (T_s MIN)	N/A
- Temperature Typical (T_s TYP)	150°C
- Temperature Maximum (T_s MAX)	N/A
- Time (t_s MIN)	60 - 120 Seconds
Ramp-up Rate (T_L to T_p)	5°C/second Maximum
Time Maintained Above:	
- Temperature (T_L)	150°C
- Time (t_L)	200 Seconds Maximum
Peak Temperature (T_p)	240°C Maximum
Target Peak Temperature (T_p Target)	240°C Maximum 1 Time / 230°C Maximum 2 Times
Time within 5°C of actual peak (t_p)	10 seconds Maximum 2 Times / 80 seconds Maximum 1 Time
Ramp-down Rate	5°C/second Maximum
Time 25°C to Peak Temperature (t)	N/A
Moisture Sensitivity Level	Level 1

Low Temperature Manual Soldering

185°C Maximum for 10 seconds Maximum, 2 times Maximum.

High Temperature Manual Soldering

260°C Maximum for 5 seconds Maximum, 2 times Maximum.