

# EMK43G2H-108.000M TR

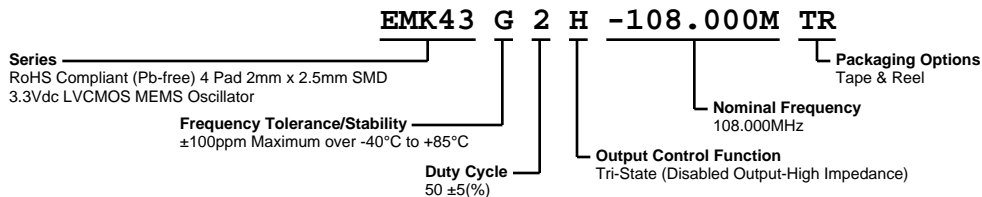

**ECLIPTEK**<sup>®</sup>  
CORPORATION



## ELECTRICAL SPECIFICATIONS

<b>Nominal Frequency</b>	108.000MHz
<b>Frequency Tolerance/Stability</b>	±100ppm Maximum over -40°C to +85°C (Inclusive of all conditions: Calibration Tolerance at 25°C, Frequency Stability over the Operating Temperature Range, Supply Voltage Change, Output Load Change, First Year Aging at 25°C, 260°C Reflow, Shock, and Vibration)
<b>Aging at 25°C</b>	±1ppm Maximum First Year
<b>Operating Temperature Range</b>	-40°C to +85°C
<b>Supply Voltage</b>	3.3Vdc ±10%
<b>Input Current</b>	25mA Maximum
<b>Output Voltage Logic High (Voh)</b>	90% of Vdd Minimum (IOH=-8mA)
<b>Output Voltage Logic Low (Vol)</b>	10% of Vdd Maximum (IOL=+8mA)
<b>Rise/Fall Time</b>	2nSec Maximum (Measured from 20% to 80% of waveform)
<b>Duty Cycle</b>	50 ±5(%) (Measured at 50% of waveform)
<b>Load Drive Capability</b>	15pF Maximum
<b>Output Logic Type</b>	CMOS
<b>Output Control Function</b>	Tri-State (Disabled Output-High Impedance)
<b>Output Control Input Voltage</b>	+0.7Vdd Minimum or No Connect to Enable Output, +0.3Vdd Maximum to Disable Output
<b>Peak to Peak Jitter (tPK)</b>	250pSec Maximum, 100pSec Typical
<b>Start Up Time</b>	50mSec Maximum
<b>Storage Temperature Range</b>	-55°C to +125°C

## ENVIRONMENTAL & MECHANICAL SPECIFICATIONS

<b>ESD Susceptibility</b>	MIL-STD-883, Method 3015, Class 2, HBM 2000V
<b>Flammability</b>	UL94-V0
<b>Mechanical Shock</b>	MIL-STD-883, Method 2002, Condition G, 30,000G
<b>Moisture Resistance</b>	MIL-STD-883, Method 1004
<b>Moisture Sensitivity Level</b>	J-STD-020, MSL 1
<b>Resistance to Soldering Heat</b>	MIL-STD-202, Method 210, Condition K
<b>Resistance to Solvents</b>	MIL-STD-202, Method 215
<b>Solderability</b>	MIL-STD-883, Method 2003 (Pads on Bottom of Package Only)
<b>Temperature Cycling</b>	MIL-STD-883, Method 1010, Condition B
<b>Thermal Shock</b>	MIL-STD-883, Method 1011, Condition B
<b>Vibration</b>	MIL-STD-883, Method 2007, Condition A, 20G

# EMK43G2H-108.000M TR

## MECHANICAL DIMENSIONS (all dimensions in millimeters)

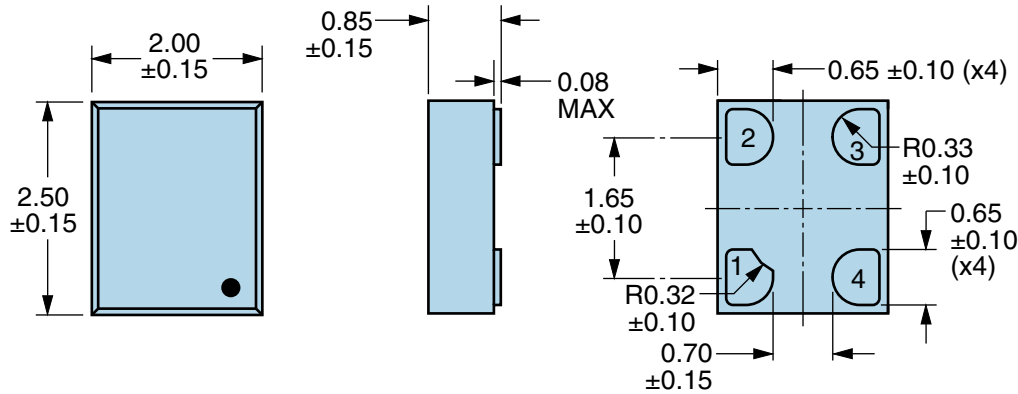

PIN	CONNECTION
1	Tri-State
2	Ground
3	Output
4	Supply Voltage

LINE	MARKING
1	XXXX XXXX=Ecliptek Manufacturing Lot Code

## Suggested Solder Pad Layout

All Dimensions in Millimeters

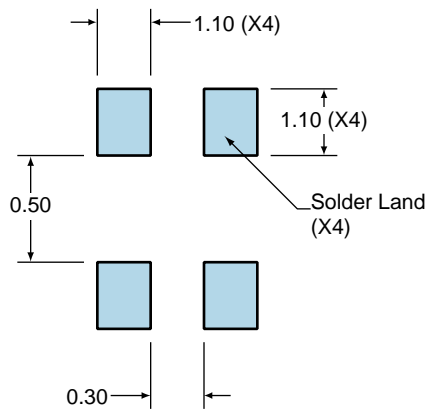

All Tolerances are  $\pm 0.1$

# EMK43G2H-108.000M TR

## OUTPUT WAVEFORM & TIMING DIAGRAM

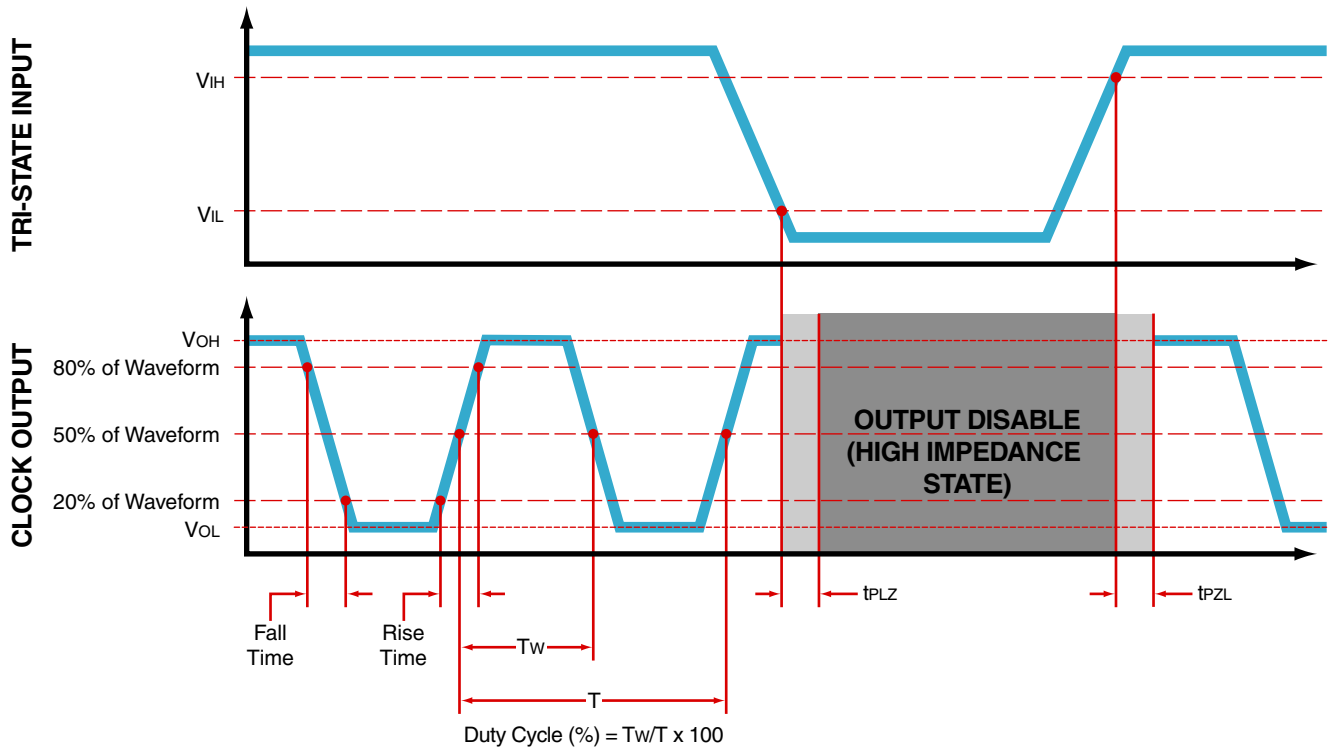

## Test Circuit for CMOS Output



Note 1: An external 0.1µF low frequency tantalum bypass capacitor in parallel with a 0.01µF high frequency ceramic bypass capacitor close to the package ground and  $V_{DD}$  pin is required.

Note 2: A low capacitance (<12pF), 10X attenuation factor, high impedance (>10Mohms), and high bandwidth (>300MHz) passive probe is recommended.

Note 3: Capacitance value  $C_L$  includes sum of all probe and fixture capacitance.

# EMK43G2H-108.000M TR

## Tape & Reel Dimensions

Quantity Per Reel: 1,000 units

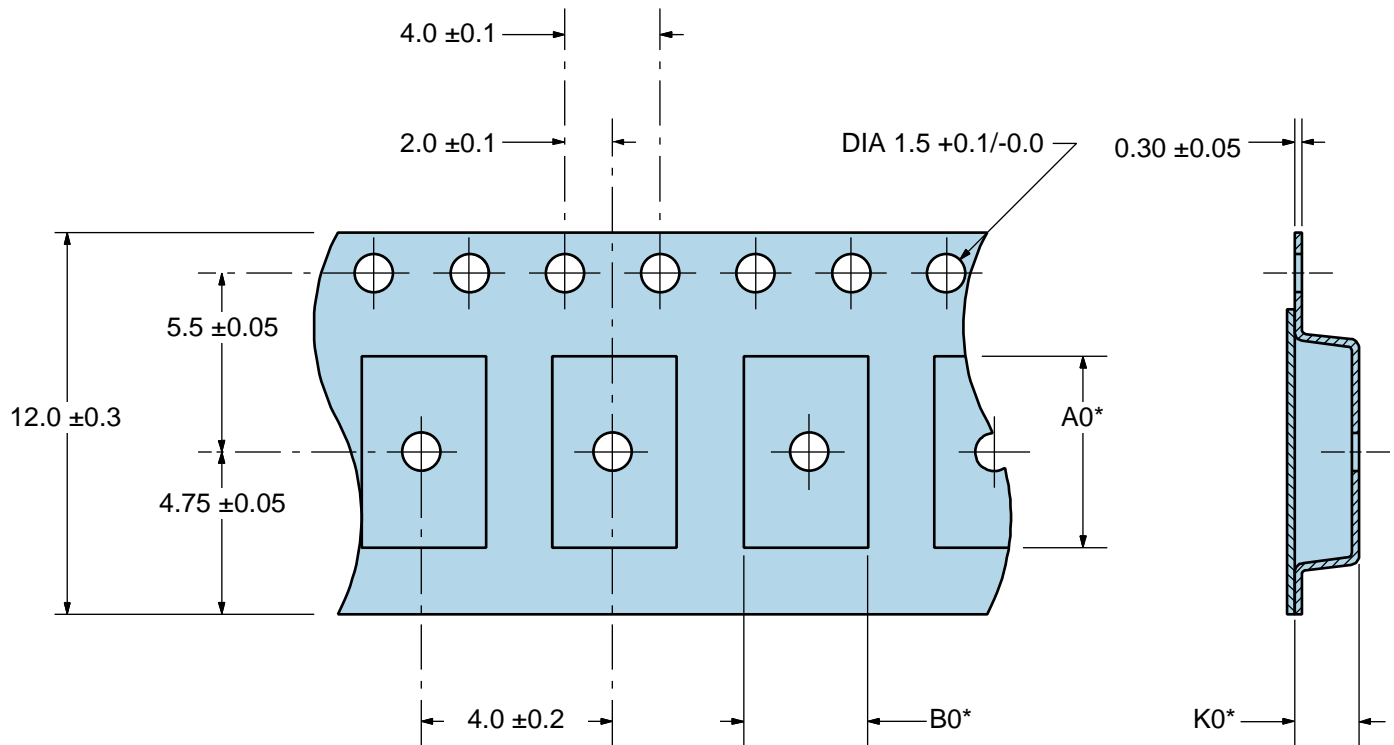

\*Compliant to EIA 481A

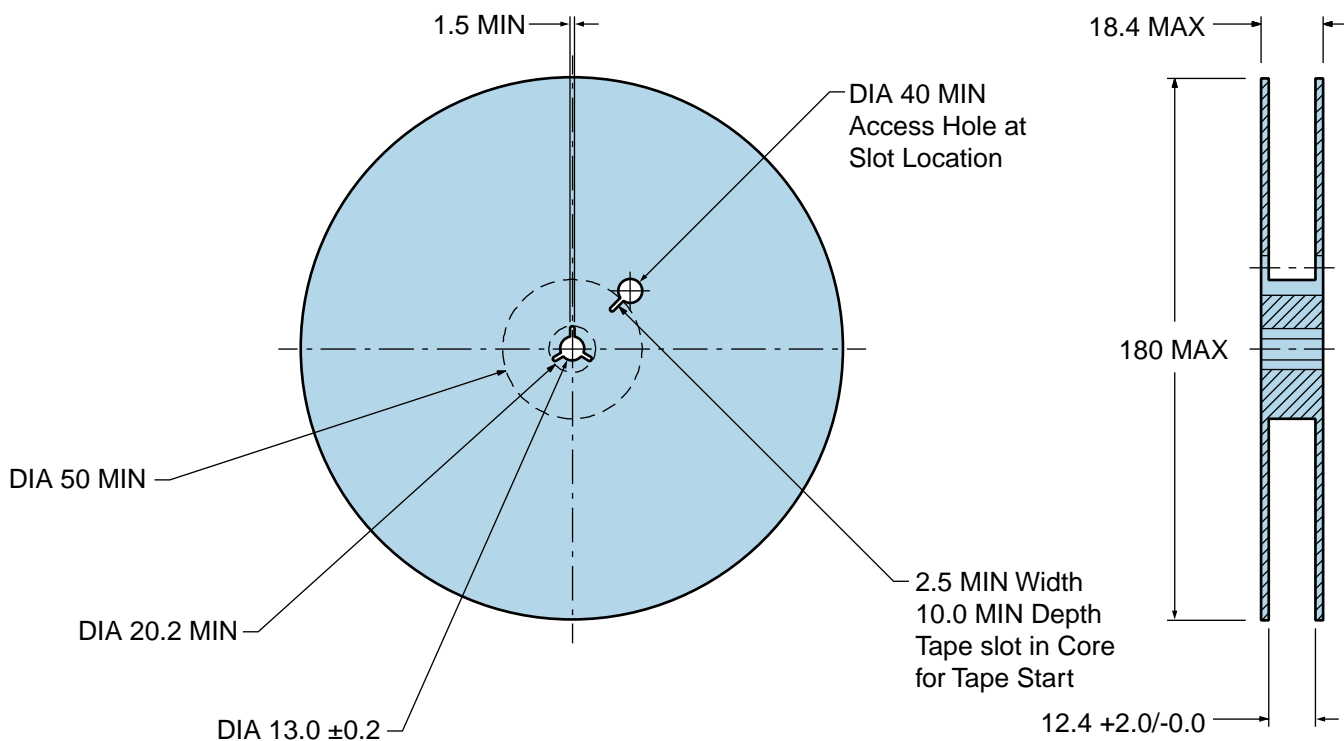

## Recommended Solder Reflow Methods



### High Temperature Infrared/Convection

<b>T<sub>s</sub> MAX to T<sub>L</sub> (Ramp-up Rate)</b>	3°C/second Maximum
<b>Preheat</b>	
- Temperature Minimum (T <sub>s</sub> MIN)	150°C
- Temperature Typical (T <sub>s</sub> TYP)	175°C
- Temperature Maximum (T <sub>s</sub> MAX)	200°C
- Time (t <sub>s</sub> MIN)	60 - 180 Seconds
<b>Ramp-up Rate (T<sub>L</sub> to T<sub>p</sub>)</b>	3°C/second Maximum
<b>Time Maintained Above:</b>	
- Temperature (T <sub>L</sub> )	217°C
- Time (t <sub>L</sub> )	60 - 150 Seconds
<b>Peak Temperature (T<sub>p</sub>)</b>	260°C Maximum for 10 Seconds Maximum
<b>Target Peak Temperature (T<sub>p</sub> Target)</b>	250°C +0/-5°C
<b>Time within 5°C of actual peak (t<sub>p</sub>)</b>	20 - 40 seconds
<b>Ramp-down Rate</b>	6°C/second Maximum
<b>Time 25°C to Peak Temperature (t)</b>	8 minutes Maximum
<b>Moisture Sensitivity Level</b>	Level 1

## Recommended Solder Reflow Methods

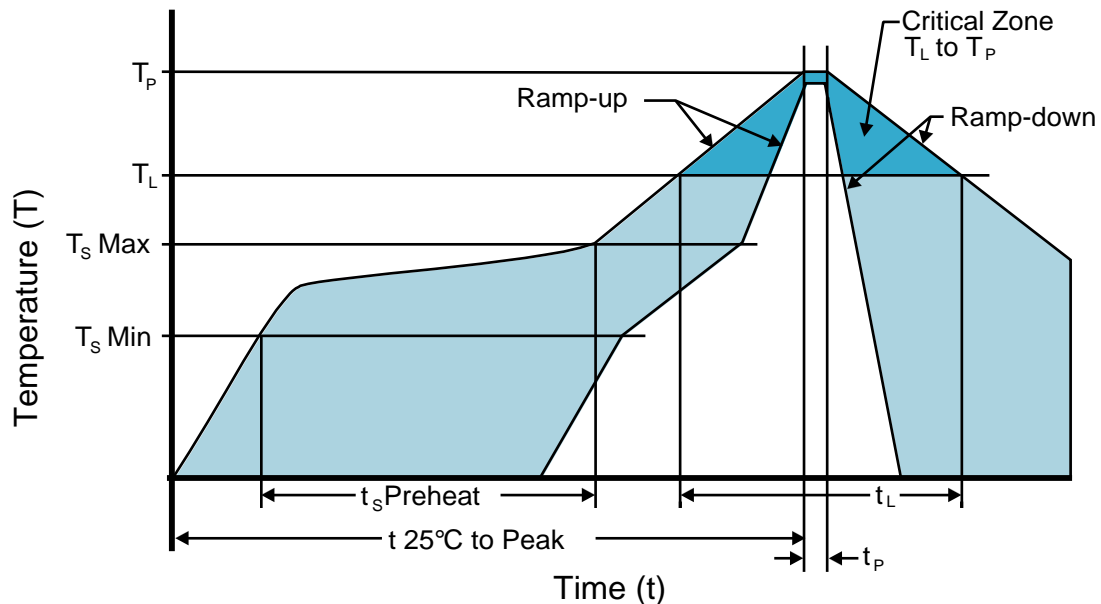

### Low Temperature Infrared/Convection 240°C

<b><math>T_S</math> MAX to <math>T_L</math> (Ramp-up Rate)</b>	5°C/second Maximum
<b>Preheat</b>	
- Temperature Minimum ( $T_S$ MIN)	N/A
- Temperature Typical ( $T_S$ TYP)	150°C
- Temperature Maximum ( $T_S$ MAX)	N/A
- Time ( $t_s$ MIN)	60 - 120 Seconds
<b>Ramp-up Rate (<math>T_L</math> to <math>T_P</math>)</b>	5°C/second Maximum
<b>Time Maintained Above:</b>	
- Temperature ( $T_L$ )	150°C
- Time ( $t_L$ )	200 Seconds Maximum
<b>Peak Temperature (<math>T_P</math>)</b>	240°C Maximum
<b>Target Peak Temperature (<math>T_P</math> Target)</b>	240°C Maximum 1 Time / 230°C Maximum 2 Times
<b>Time within 5°C of actual peak (<math>t_p</math>)</b>	10 seconds Maximum 2 Times / 80 seconds Maximum 1 Time
<b>Ramp-down Rate</b>	5°C/second Maximum
<b>Time 25°C to Peak Temperature (t)</b>	N/A
<b>Moisture Sensitivity Level</b>	Level 1

### Low Temperature Manual Soldering

185°C Maximum for 10 seconds Maximum, 2 times Maximum.

### High Temperature Manual Soldering

260°C Maximum for 5 seconds Maximum, 2 times Maximum.