

EV31C6A3A1-6.176M TR

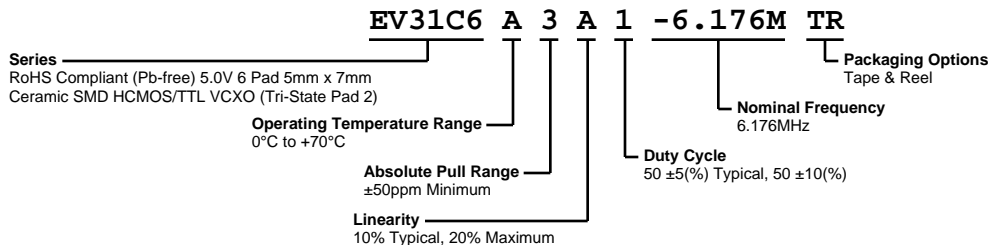

ELECTRICAL SPECIFICATIONS

Nominal Frequency	6.176MHz
Frequency Tolerance/Stability	±50ppm Maximum (Inclusive of all conditions: Calibration Tolerance at 25°C, Frequency Stability over the Operating Temperature Range, Supply Voltage Change, Output Load Change, Shock, and Vibration.)
Aging at 40°C	±2ppm/First year typical, ±10ppm/10 Years Maximum
Operating Temperature Range	0°C to +70°C
Supply Voltage	5.0Vdc ±10%
Input Current	25mA Maximum
Output Voltage Logic High (Voh)	90% of Vdd Minimum (IOH = -4mA)
Output Voltage Logic Low (Vol)	10% of Vdd Maximum (IOL = +4mA)
Rise/Fall Time	5nSec Maximum (Measured at 0.4Vdc to 2.4Vdc with TTL Load; Measured at 20% to 80% of waveform with HCMOS Load)
Duty Cycle	50 ±5(%) Typical, 50 ±10(%) (Measured at 1.4Vdc with TTL Load; Measured at 50% of waveform with HCMOS Load)
Load Drive Capability	10TTL Load or 30pF HCMOS Load Maximum
Output Logic Type	CMOS
Absolute Pull Range	±50ppm Minimum (Inclusive of all conditions: Calibration Tolerance at 25°C, Frequency Stability over the Operating Temperature Range, Supply Voltage Change, Output Load Change, Shock, Vibration, and Aging over the Control Voltage (Vc).)
Control Voltage	0.5Vdc to 4.5Vdc (Test Condition for Absolute Pull Range)
Control Voltage Range	0.0Vdc to Vdd
Linearity	10% Typical, 20% Maximum
Transfer Function	Positive Transfer Characteristic
Modulation Bandwidth	10kHz Minimum (Measured at -3dB, Vc = 2.5Vdc)
Input Impedance	50kOhms Minimum
Input Leakage Current	10µA Maximum
Phase Noise	-70dBc/Hz at offset of 10Hz, -100dBc/Hz at offset of 100Hz, -130dBc/Hz at offset of 1kHz, -147dBc/Hz at offset of 10kHz, -152dBc/Hz at offset of 100kHz, and -155dBc/Hz at offset of 1MHz (Typical values at Fo = 27MHz)
Tri-State Input Voltage (Vih and Vil)	+0.9Vdd Minimum to Enable Output; +0.1Vdd Maximum to Disable Output (High Impedance); No Connect to Enable Output.
RMS Phase Jitter	1pSec Maximum (Fj = 12kHz to 20MHz)
Start Up Time	10mSec Maximum
Storage Temperature Range	-55°C to +125°C

ENVIRONMENTAL & MECHANICAL SPECIFICATIONS

Fine Leak Test	MIL-STD-883, Method 1014 Condition A
Gross Leak Test	MIL-STD-883, Method 1014 Condition C
Mechanical Shock	MIL-STD-202, Method 213 Condition C
Resistance to Soldering Heat	MIL-STD-202, Method 210
Resistance to Solvents	MIL-STD-202, Method 215
Solderability	MIL-STD-883, Method 2003
Temperature Cycling	MIL-STD-883, Method 1010
Vibration	MIL-STD-883, Method 2007 Condition A

EV31C6A3A1-6.176M TR

MECHANICAL DIMENSIONS (all dimensions in millimeters)

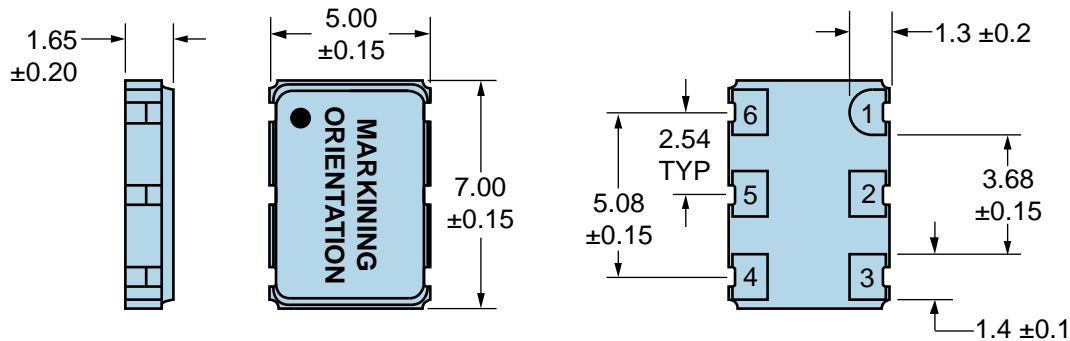

PIN	CONNECTION
1	Voltage Control
2	Tri-State
3	Case Ground
4	Output
5	No Connect
6	Supply Voltage

LINE	MARKING
1	ECLIPTEK
2	6.176M
3	XXYZZ XX=Ecliptek Manufacturing Code Y=Last Digit of Year ZZ=Week of Year

Suggested Solder Pad Layout

All Dimensions in Millimeters

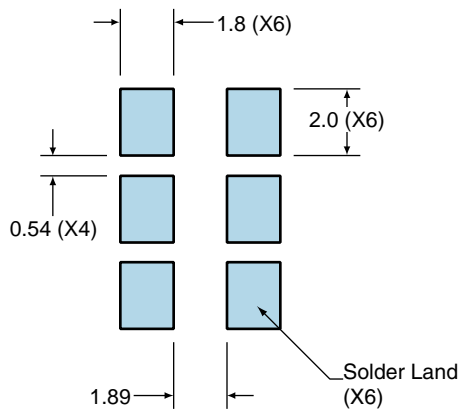

All Tolerances are ±0.1

OUTPUT WAVEFORM

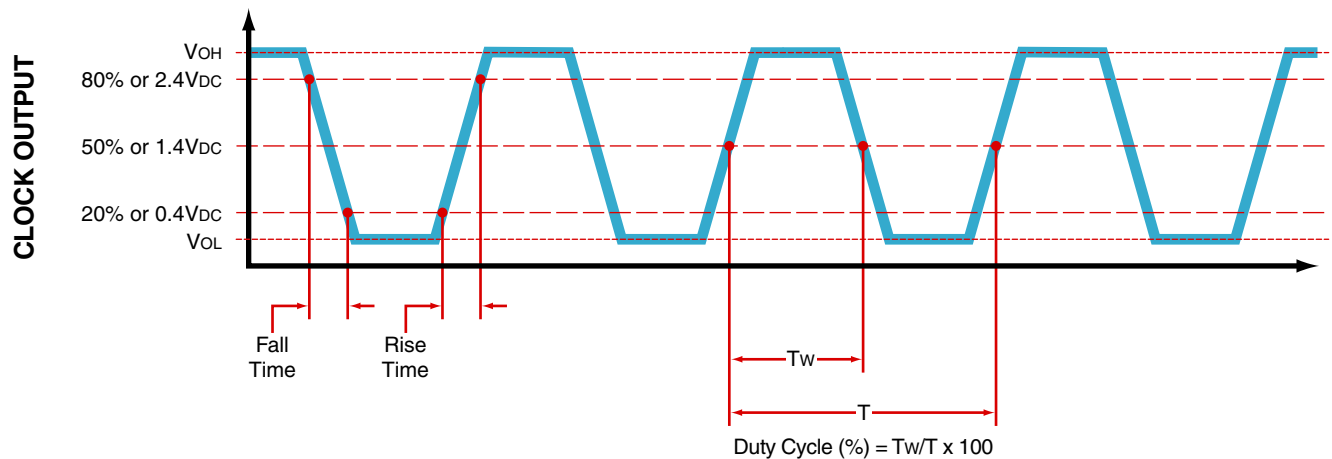

EV31C6A3A1-6.176M TR

Test Circuit for TTL Output

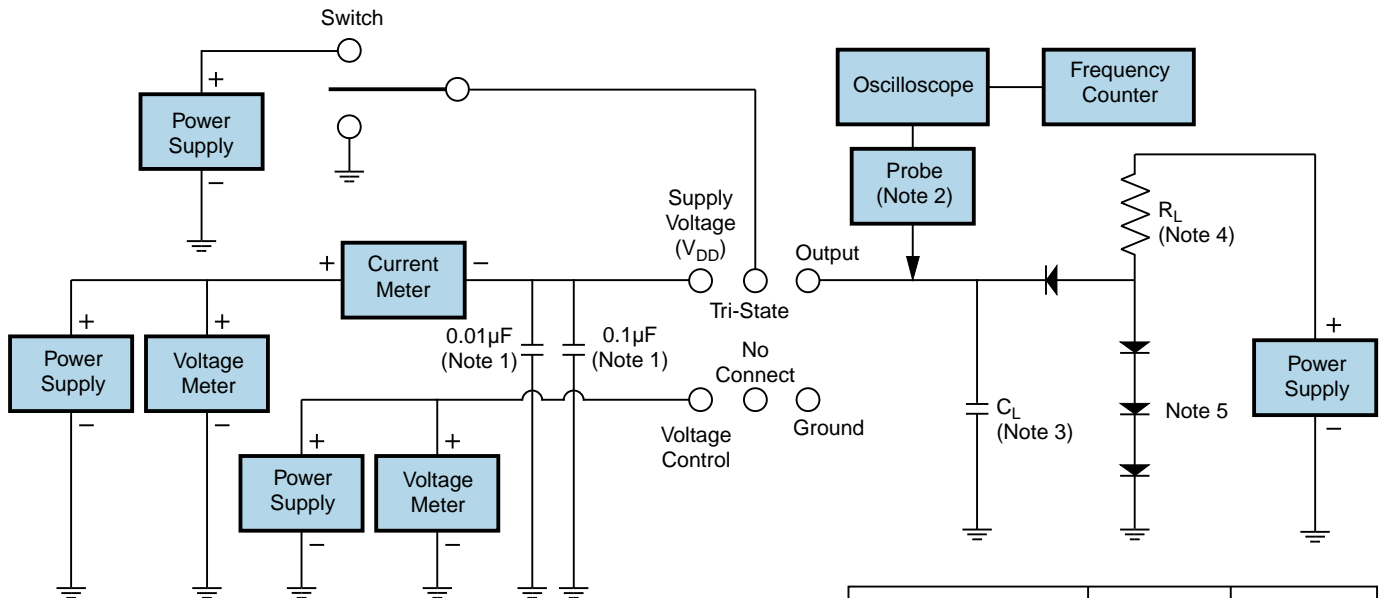

Note 1: An external 0.1µF low frequency tantalum bypass capacitor in parallel with a 0.01µF high frequency ceramic bypass capacitor close to the package ground and V_{DD} pin is required.

Note 2: A low capacitance (<12pF), 10X attenuation factor, high impedance (>10Mohms), and high bandwidth (>300MHz) passive probe is recommended.

Note 3: Capacitance value C_L includes sum of all probe and fixture capacitance.

Note 4: Resistance value R_L is shown in Table 1. See applicable specification sheet for 'Load Drive Capability'.

Note 5: All diodes are MMBD7000, MMBD914, or equivalent.

Output Load Drive Capability	R _L Value (Ohms)	C _L Value (pF)
10TTL	390	15
5TTL	780	15
2TTL	1100	6
10LSTTL	2000	15
1TTL	2200	3

Table 1: R_L Resistance Value and C_L Capacitance Value Vs. Output Load Drive Capability

EV31C6A3A1-6.176M TR

Test Circuit for CMOS Output

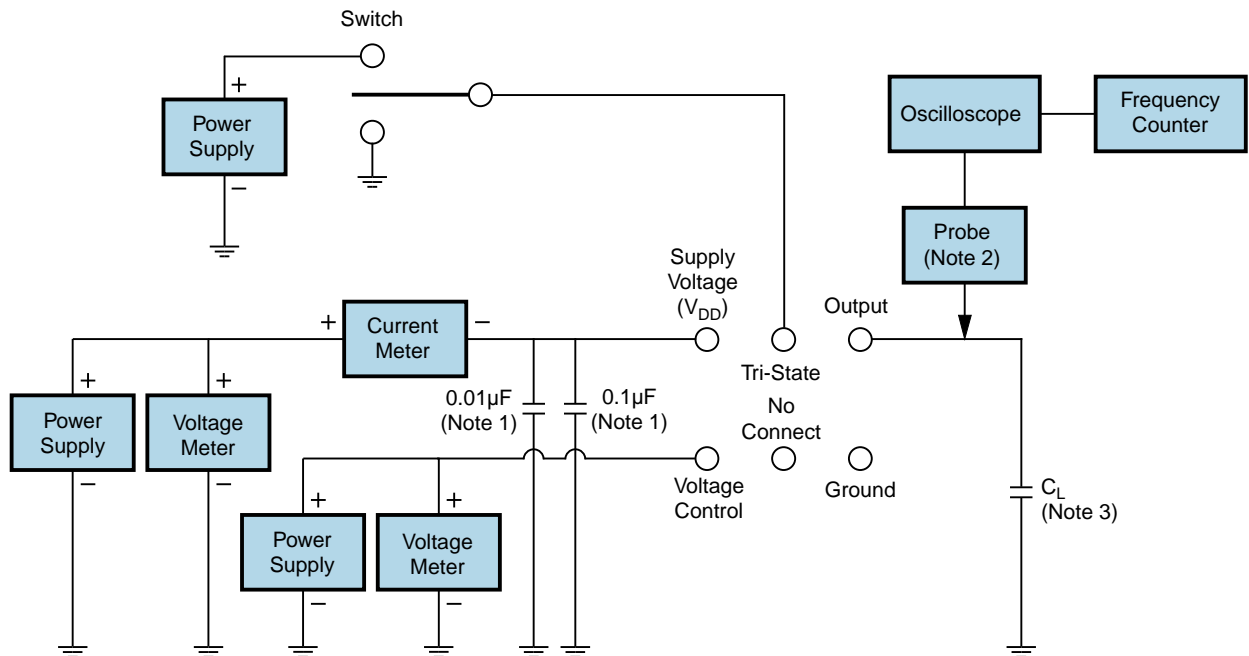

Note 1: An external $0.1\mu\text{F}$ low frequency tantalum bypass capacitor in parallel with a $0.01\mu\text{F}$ high frequency ceramic bypass capacitor close to the package ground and V_{DD} pin is required.

Note 2: A low capacitance ($<12\text{pF}$), 10X attenuation factor, high impedance ($>10\text{Mohms}$), and high bandwidth ($>300\text{MHz}$) passive probe is recommended.

Note 3: Capacitance value C_L includes sum of all probe and fixture capacitance.

EV31C6A3A1-6.176M TR

Tape & Reel Dimensions

Quantity Per Reel: 1,000 units

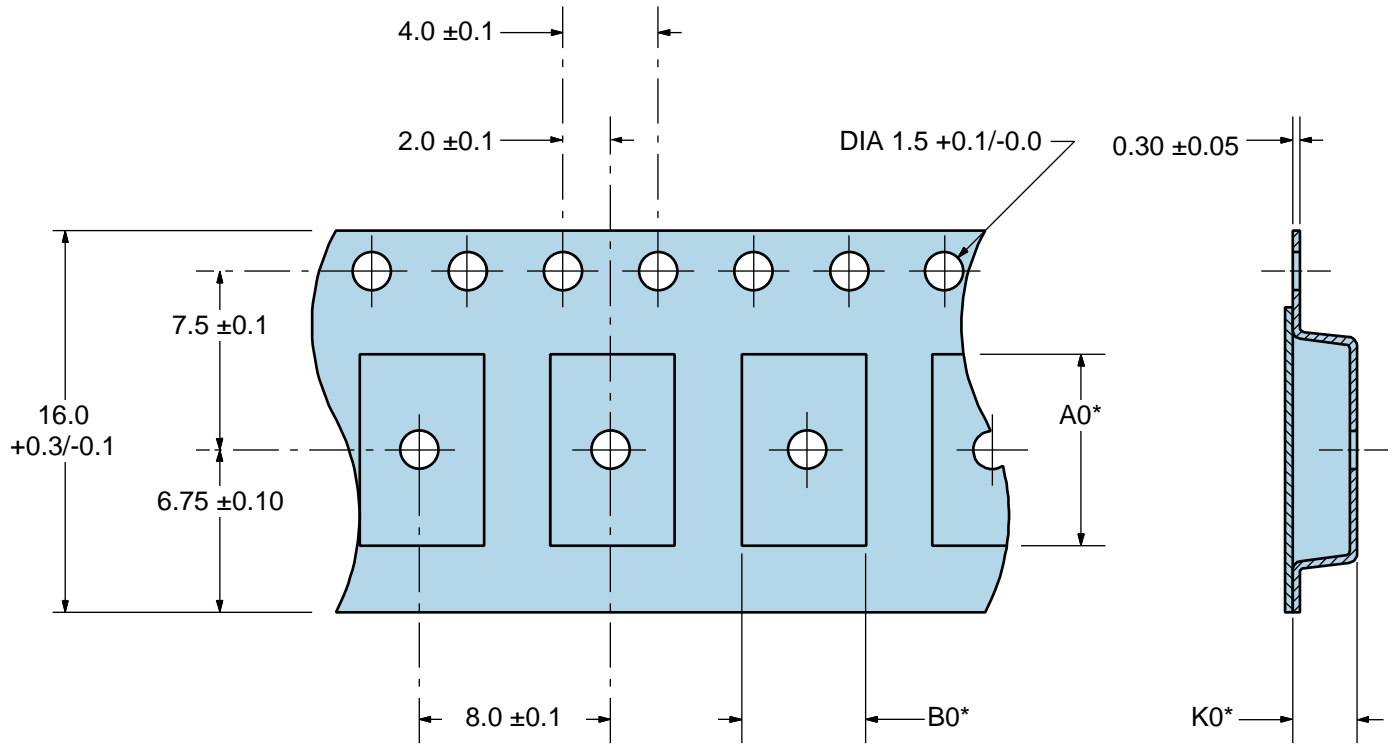

*Compliant to EIA 481A

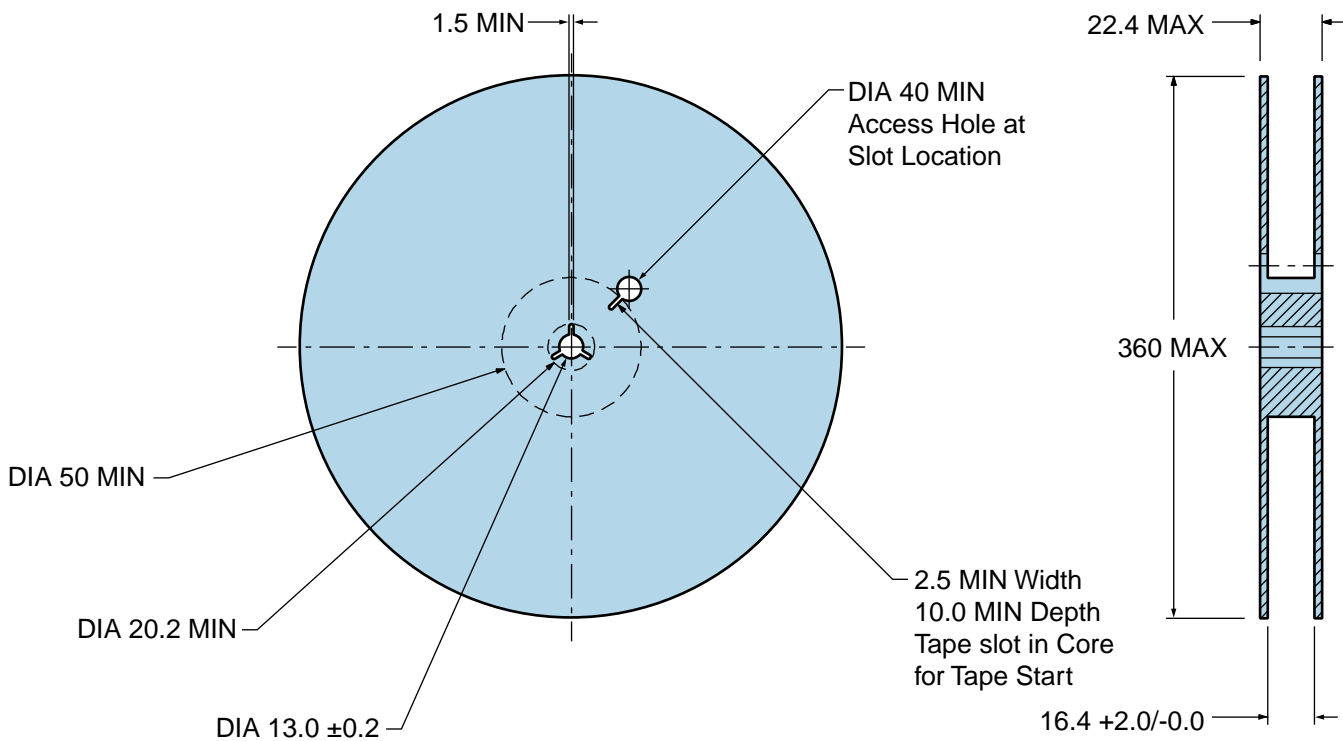

Recommended Solder Reflow Methods



High Temperature Infrared/Convection

T_S MAX to T_L (Ramp-up Rate) 3°C/second Maximum

Preheat

- Temperature Minimum (T_S MIN) 150°C
- Temperature Typical (T_S TYP) 175°C
- Temperature Maximum (T_S MAX) 200°C
- Time (t_s MIN) 60 - 180 Seconds

Ramp-up Rate (T_L to T_P) 3°C/second Maximum

Time Maintained Above:

- Temperature (T_L) 217°C
- Time (t_L) 60 - 150 Seconds

Peak Temperature (T_P) 260°C Maximum for 10 Seconds Maximum

Target Peak Temperature (T_P Target) 250°C +0/-5°C

Time within 5°C of actual peak (t_p) 20 - 40 seconds

Ramp-down Rate 6°C/second Maximum

Time 25°C to Peak Temperature (t) 8 minutes Maximum

Moisture Sensitivity Level Level 1

Recommended Solder Reflow Methods



Low Temperature Infrared/Convection 240°C

T_s MAX to T_L (Ramp-up Rate)	5°C/second Maximum
Preheat	
- Temperature Minimum (T_s MIN)	N/A
- Temperature Typical (T_s TYP)	150°C
- Temperature Maximum (T_s MAX)	N/A
- Time (t_s MIN)	60 - 120 Seconds
Ramp-up Rate (T_L to T_p)	5°C/second Maximum
Time Maintained Above:	
- Temperature (T_L)	150°C
- Time (t_L)	200 Seconds Maximum
Peak Temperature (T_p)	240°C Maximum
Target Peak Temperature (T_p Target)	240°C Maximum 1 Time / 230°C Maximum 2 Times
Time within 5°C of actual peak (t_p)	10 seconds Maximum 2 Times / 80 seconds Maximum 1 Time
Ramp-down Rate	5°C/second Maximum
Time 25°C to Peak Temperature (t)	N/A
Moisture Sensitivity Level	Level 1

Low Temperature Manual Soldering

185°C Maximum for 10 seconds Maximum, 2 times Maximum.

High Temperature Manual Soldering

260°C Maximum for 5 seconds Maximum, 2 times Maximum.