

BLF6G21-10G

Power LDMOS transistor

Rev. 02 — 11 December 2009

Product data sheet

1. Product profile

1.1 General description

10 W LDMOS power transistor for base station applications at frequencies from HF to 2200 MHz

Table 1. Typical performance

$I_{DQ} = 100 \text{ mA}$; $T_{case} = 25^\circ \text{C}$ in a common source class-AB production test circuit.

Mode of operation	f (MHz)	V _{DS} (V)	P _{L(AV)} (W)	G _p (dB)	η _D (%)	ACPR (dBc)
2-carrier W-CDMA	2110 to 2170	28	0.7	18.5	15	-50 ^[1]
1-carrier W-CDMA	2110 to 2170	28	2	19.3	31	-39 ^[1]

[1] Test signal: 3GPP; test model 1; 64 DPCH; PAR = 7.5 dB at 0.01 % probability on CCDF per carrier; carrier spacing 5 MHz.

CAUTION



This device is sensitive to ElectroStatic Discharge (ESD). Therefore care should be taken during transport and handling.

1.2 Features

- Typical 2-carrier W-CDMA performance at frequencies of 2110 MHz and 2170 MHz, a supply voltage of 28 V and an I_{DQ} of 100 mA:
 - ◆ Average output power = 0.7 W
 - ◆ Gain = 18.5 dB
 - ◆ Efficiency = 15 %
 - ◆ ACPR = -50 dBc
- Typical 1-carrier W-CDMA performance at frequencies of 2110 MHz and 2170 MHz, a supply voltage of 28 V and an I_{DQ} of 100 mA:
 - ◆ Average output power = 2 W
 - ◆ Gain = 19.3 dB
 - ◆ Efficiency = 31 %
 - ◆ ACPR = -39 dBc
- Easy power control
- Integrated ESD protection
- Excellent ruggedness
- High efficiency

- Excellent thermal stability
- No internal matching for broadband operation
- Compliant to Directive 2002/95/EC, regarding Restriction of Hazardous Substances (RoHS)

1.3 Applications

- RF power amplifiers for GSM, PHS, EDGE, CDMA and W-CDMA base stations and multi carrier applications in the HF to 2200 MHz frequency range
- Broadcast drivers

2. Pinning information

Table 2. Pinning

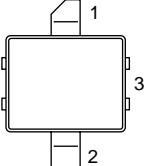
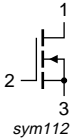
Pin	Description	Simplified outline	Graphic symbol
1	drain		
2	gate		
3	source		

[1] Connected to flange.

3. Ordering information

Table 3. Ordering information

Type number	Package		
	Name	Description	Version
BLF6G21-10G	-	ceramic surface-mounted package; 2 leads	SOT538A

4. Limiting values

Table 4. Limiting values

In accordance with the Absolute Maximum Rating System (IEC 60134).

Symbol	Parameter	Conditions	Min	Max	Unit
V_{DS}	drain-source voltage		-	65	V
V_{GS}	gate-source voltage		-0.5	+13	V
T_{stg}	storage temperature		-65	+150	°C
T_j	junction temperature		-	225	°C

5. Thermal characteristics

Table 5. Thermal characteristics

Symbol	Parameter	Conditions	Typ	Unit
$R_{th(j-case)}$	thermal resistance from junction to case	$T_{case} = 80\text{ °C}$; $P_{L(AV)} = 11\text{ W}$	[1] 3.2	K/W

[1] Thermal resistance is determined under specified RF operating conditions

6. Characteristics

Table 6. Characteristics

$T_j = 25\text{ °C}$ unless otherwise specified

Symbol	Parameter	Conditions	Min	Typ	Max	Unit
$V_{(BR)DSS}$	drain-source breakdown voltage	$V_{GS} = 0\text{ V}$; $I_D = 0.5\text{ mA}$	65	-	-	V
$V_{GS(th)}$	gate-source threshold voltage	$V_{DS} = 10\text{ V}$; $I_D = 18\text{ mA}$	1.4	1.9	2.4	V
I_{DSS}	drain leakage current	$V_{GS} = 0\text{ V}$; $V_{DS} = 28\text{ V}$	-	-	1.5	μA
I_{DSX}	drain cut-off current	$V_{GS} = V_{GS(th)} + 3.75\text{ V}$; $V_{DS} = 10\text{ V}$	-	3.1	-	A
I_{GSS}	gate leakage current	$V_{GS} = 11\text{ V}$; $V_{DS} = 0\text{ V}$	-	-	150	nA
g_{fs}	forward transconductance	$V_{DS} = 10\text{ V}$; $I_D = 0.9\text{ A}$	-	0.5	-	S
$R_{DS(on)}$	drain-source on-state resistance	$V_{GS} = V_{GS(th)} + 3.75\text{ V}$; $I_D = 0.625\text{ A}$	-	0.4	-	Ω
C_{rs}	feedback capacitance	$V_{GS} = 0\text{ V}$; $V_{DS} = 28\text{ V}$; $f = 1\text{ MHz}$	-	0.5	-	pF

7. Application information

Table 7. Application information

Mode of operation: 2-carrier W-CDMA; PAR 7.5 dB at 0.01 % probability on CCDF; 3GPP test model 1; 1-64 PDPCH; $f_1 = 2112.5\text{ MHz}$; $f_2 = 2117.5\text{ MHz}$; $f_3 = 2162.5\text{ MHz}$; $f_4 = 2167.5\text{ MHz}$; RF performance at $V_{DS} = 28\text{ V}$; $I_{Dq} = 100\text{ mA}$; $T_{case} = 25\text{ °C}$; unless otherwise specified; in a class-AB production test circuit.

Symbol	Parameter	Conditions	Min	Typ	Max	Unit
G_p	power gain	$P_{L(AV)} = 0.7\text{ W}$	-	18.5	-	dB
η_D	drain efficiency	$P_{L(AV)} = 0.7\text{ W}$	-	15	-	%
ACPR	adjacent channel power ratio	$P_{L(AV)} = 0.7\text{ W}$	-	-50	-	dBc

Table 8. Application information

Mode of operation: 1-carrier W-CDMA; PAR 7.5 dB at 0.01 % probability on CCDF; 3GPP test model 1; 1-64 PDPCH; $f_1 = 2112.5\text{ MHz}$; $f_2 = 2167.5\text{ MHz}$; RF performance at $V_{DS} = 28\text{ V}$; $I_{Dq} = 100\text{ mA}$; $T_{case} = 25\text{ °C}$; unless otherwise specified; in a class-AB production test circuit.

Symbol	Parameter	Conditions	Min	Typ	Max	Unit
G_p	power gain	$P_{L(AV)} = 2\text{ W}$	17.3	19.3	-	dB
η_D	drain efficiency	$P_{L(AV)} = 2\text{ W}$	29	31	-	%
ACPR	adjacent channel power ratio	$P_{L(AV)} = 2\text{ W}$	-	-39	-36	dBc

7.1 Ruggedness in class-AB operation

The BLF6G21-10G is capable of withstanding a load mismatch corresponding to $VSWR = 10 : 1$ through all phases under the following conditions: $V_{DS} = 28\text{ V}$; $f = 2140\text{ MHz}$ at $P_L = 10\text{ W}$.

7.2 CW

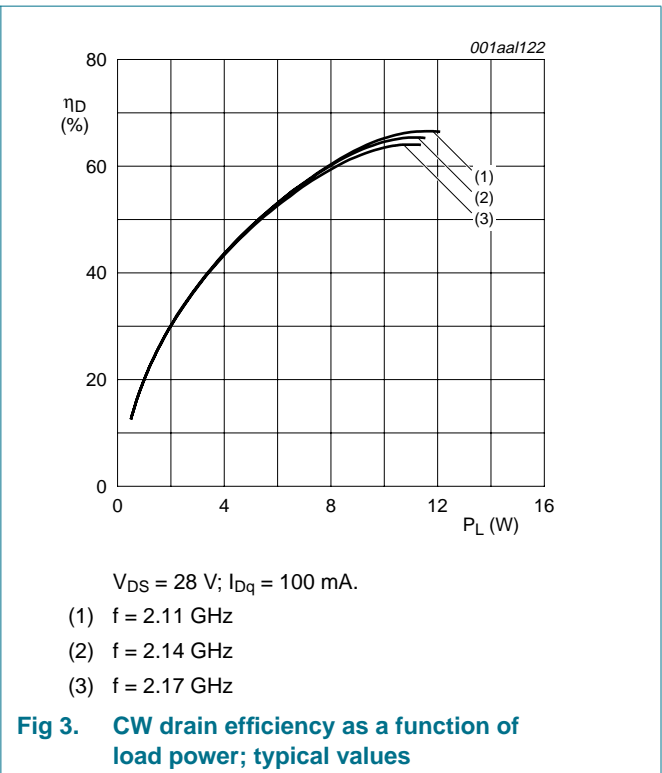
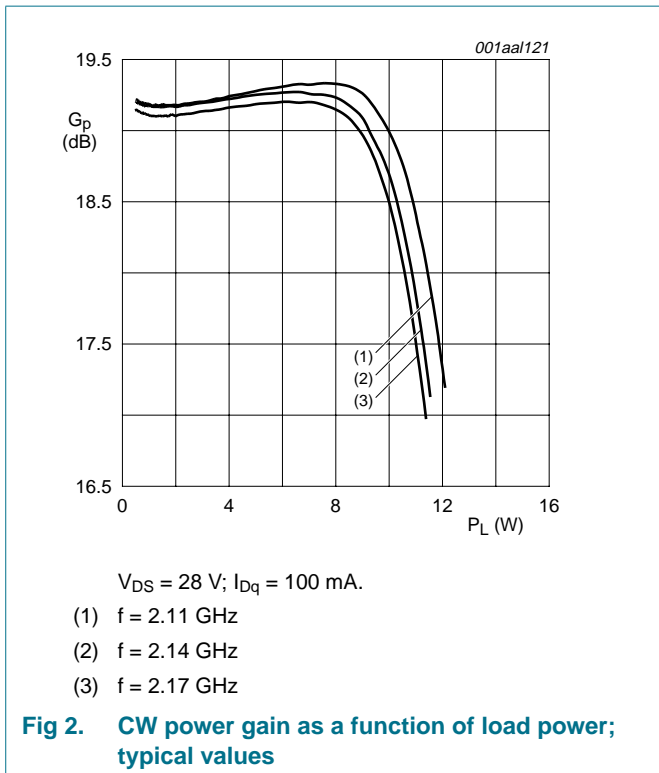
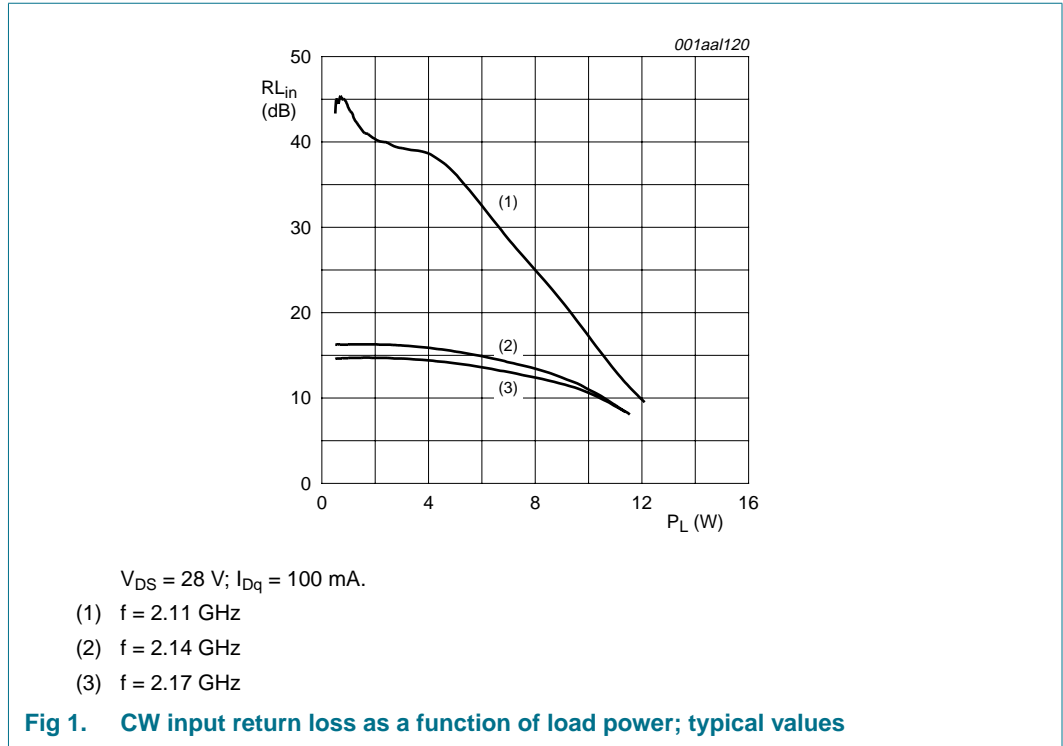

7.3 1-carrier W-CDMA

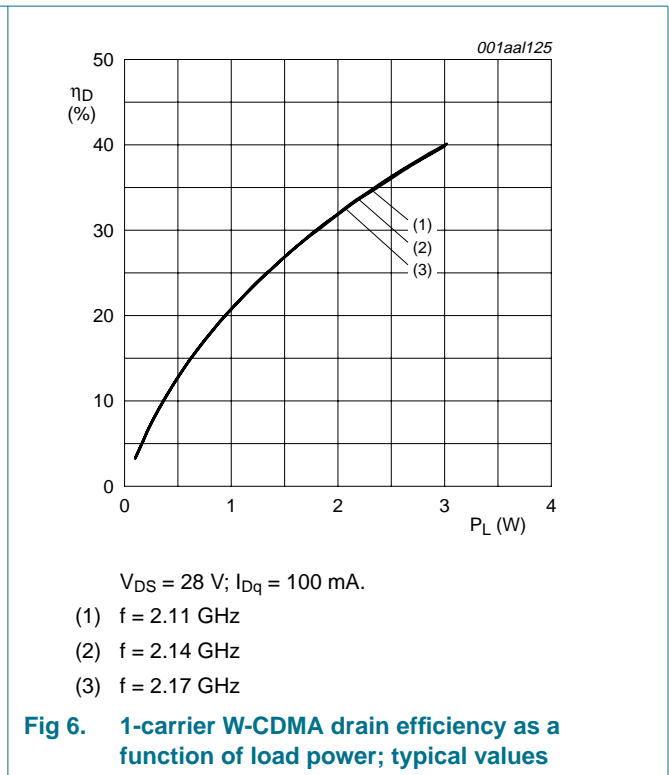
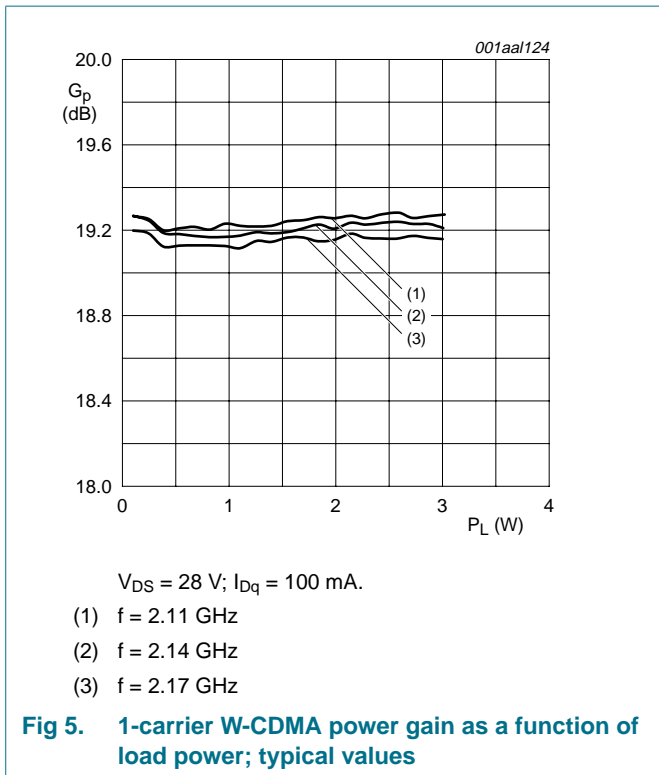
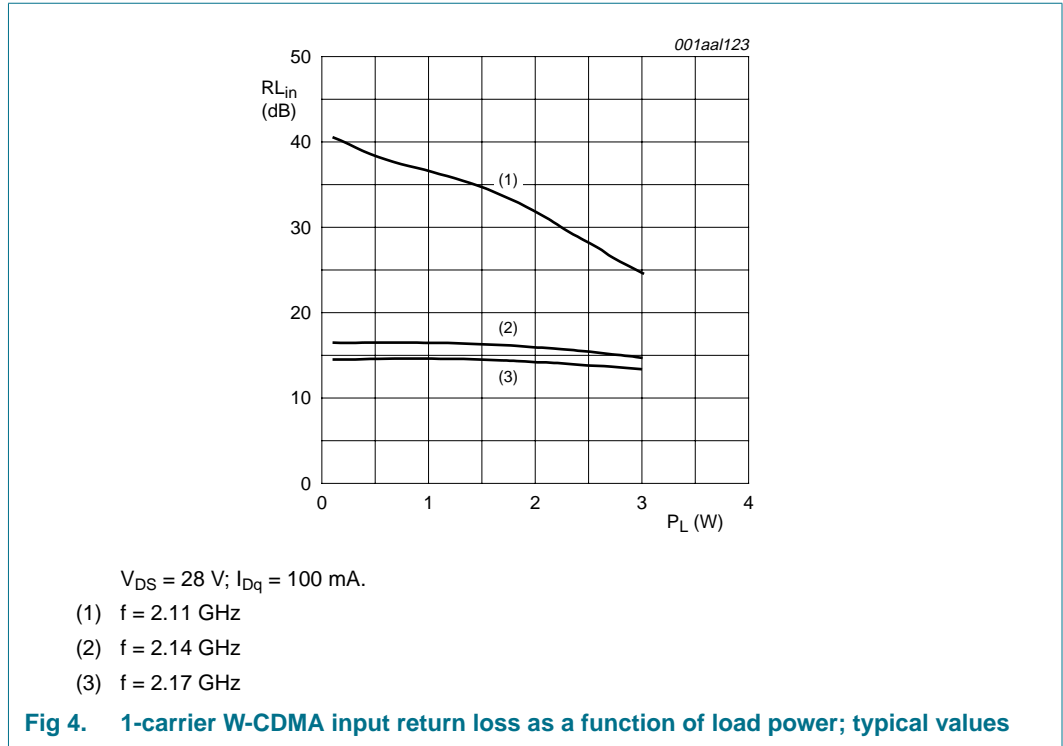

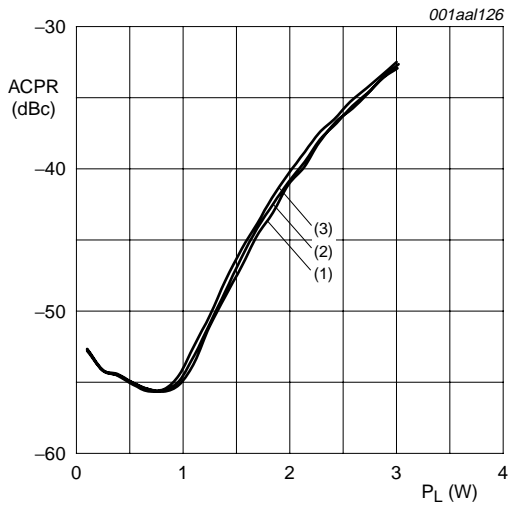

$V_{DS} = 28\text{ V}$; $I_{Dq} = 100\text{ mA}$; carrier spacing 5 MHz.
 (1) $f = 2.11\text{ GHz}$
 (2) $f = 2.14\text{ GHz}$
 (3) $f = 2.17\text{ GHz}$

Fig 7. 1-carrier W-CDMA adjacent channel power ratio as a function of load power; typical values

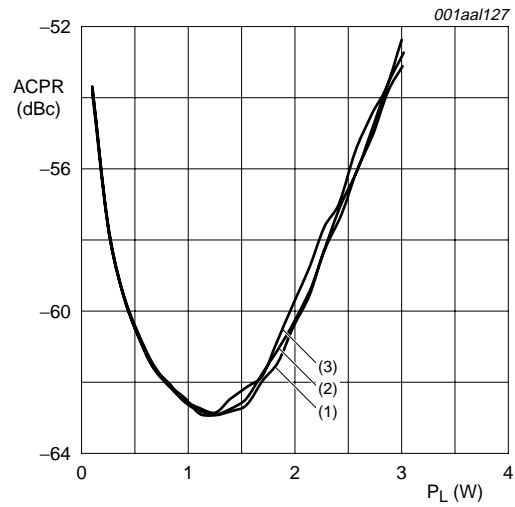

$V_{DS} = 28\text{ V}$; $I_{Dq} = 100\text{ mA}$; carrier spacing 10 MHz.
 (1) $f = 2.11\text{ GHz}$
 (2) $f = 2.14\text{ GHz}$
 (3) $f = 2.17\text{ GHz}$

Fig 8. 1-carrier W-CDMA adjacent channel power ratio as a function of load power; typical values

7.4 2-carrier W-CDMA

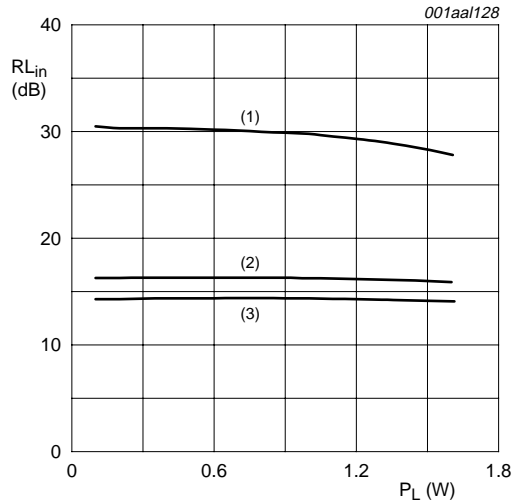

$V_{DS} = 28\text{ V}$; $I_{Dq} = 100\text{ mA}$.
 (1) $f = 2.11\text{ GHz}$
 (2) $f = 2.14\text{ GHz}$
 (3) $f = 2.17\text{ GHz}$

Fig 9. 2-carrier W-CDMA input return loss as a function of load power; typical values

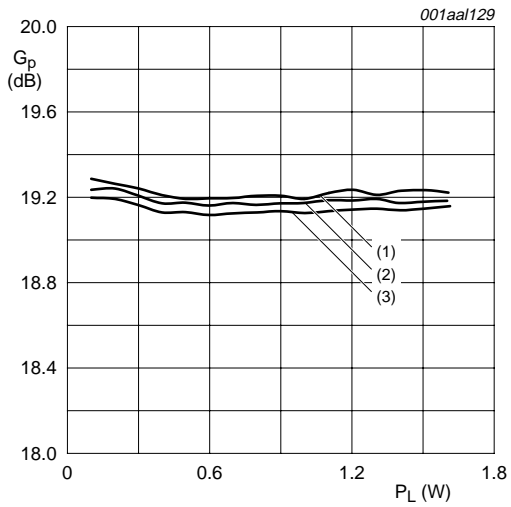

$V_{DS} = 28\text{ V}; I_{DQ} = 100\text{ mA}.$
 (1) $f = 2.11\text{ GHz}$
 (2) $f = 2.14\text{ GHz}$
 (3) $f = 2.17\text{ GHz}$

Fig 10. 2-carrier W-CDMA power gain as a function of load power; typical values

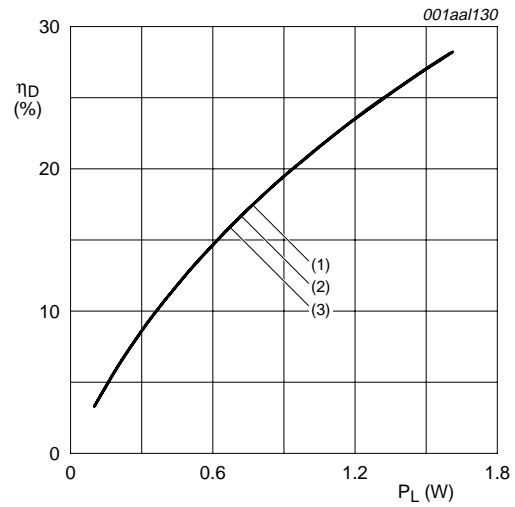

$V_{DS} = 28\text{ V}; I_{DQ} = 100\text{ mA}.$
 (1) $f = 2.11\text{ GHz}$
 (2) $f = 2.14\text{ GHz}$
 (3) $f = 2.17\text{ GHz}$

Fig 11. 2-carrier W-CDMA drain efficiency as a function of load power; typical values

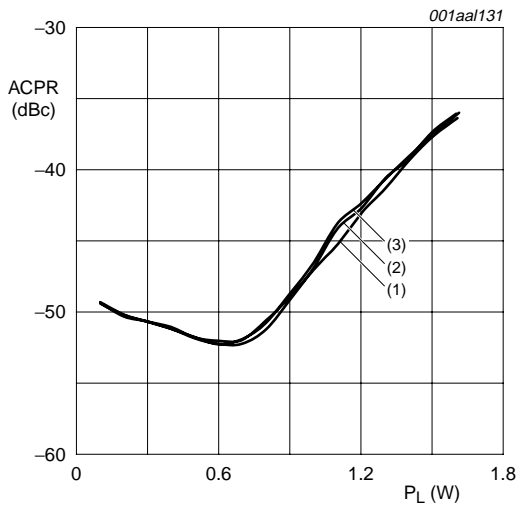

$V_{DS} = 28\text{ V}; I_{DQ} = 100\text{ mA};$ carrier spacing 5 MHz.
 (1) $f = 2.11\text{ GHz}$
 (2) $f = 2.14\text{ GHz}$
 (3) $f = 2.17\text{ GHz}$

Fig 12. 2-carrier W-CDMA adjacent channel power ratio as a function of load power; typical values

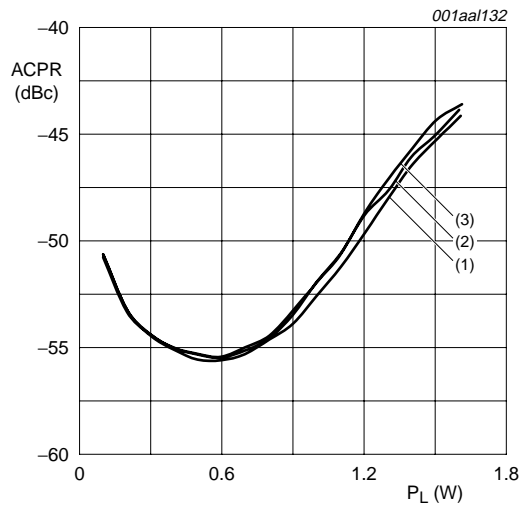

$V_{DS} = 28\text{ V}; I_{DQ} = 100\text{ mA};$ carrier spacing 10 MHz.
 (1) $f = 2.11\text{ GHz}$
 (2) $f = 2.14\text{ GHz}$
 (3) $f = 2.17\text{ GHz}$

Fig 13. 2-carrier W-CDMA adjacent channel power ratio as a function of load power; typical values

8. Package outline

Ceramic surface-mounted package; 2 leads

SOT538A

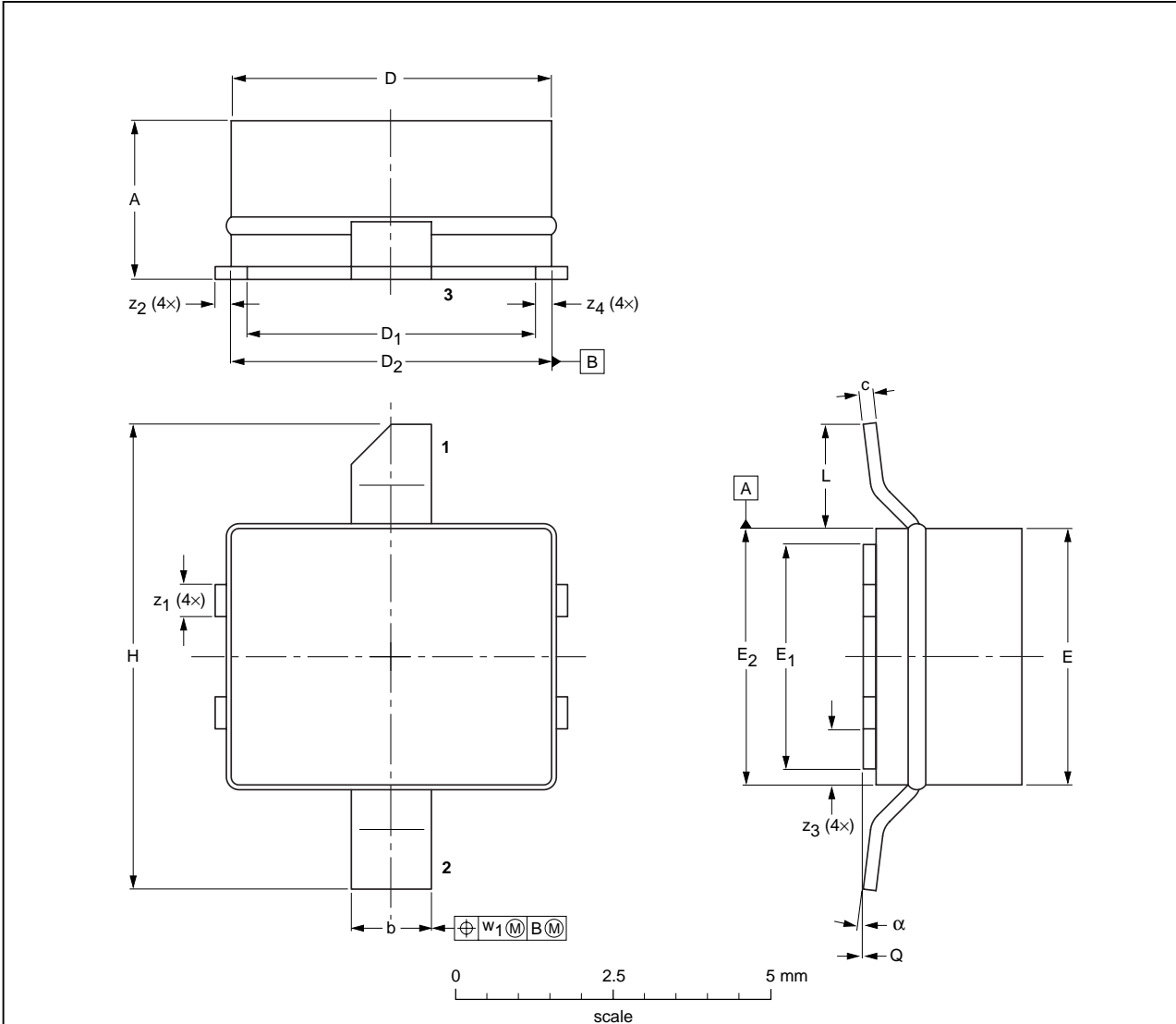

DIMENSIONS (millimetre dimensions are derived from the original inch dimensions)

UNIT	A	b	c	D	D ₁	D ₂	E	E ₁	E ₂	H	L	Q	w ₁	z ₁	z ₂	z ₃	z ₄	α
mm	2.95	1.35	0.23	5.16	4.65	5.16	4.14	3.63	4.14	7.49	2.03	0.10	0.25	0.58	0.25	0.97	0.51	7°
	2.29	1.19	0.18	5.00	4.50	5.00	3.99	3.48	3.99	7.24	1.27	0.00	0.25	0.43	0.18	0.81	0.00	0°
inches	0.116	0.053	0.009	0.203	0.183	0.203	0.163	0.143	0.163	0.295	0.080	0.004	0.010	0.023	0.010	0.038	0.020	7°
	0.090	0.047	0.007	0.197	0.177	0.197	0.157	0.137	0.157	0.285	0.050	0.000	0.010	0.017	0.007	0.032	0.000	0°

OUTLINE VERSION	REFERENCES				EUROPEAN PROJECTION	ISSUE DATE
	IEC	JEDEC	JEITA			
SOT538A						02-08-20 06-03-16

Fig 14. Package outline SOT538A

9. Abbreviations

Table 9. Abbreviations

Acronym	Description
3GPP	Third Generation Partnership Project
CCDF	Complementary Cumulative Distribution Function
CDMA	Code Division Multiple Access
CW	Continuous Wave
DPCH	Dedicated Physical CHannel
EDGE	Enhanced Data rates for GSM Evolution
GSM	Global System for Mobile communications
HF	High Frequency
LDMOS	Laterally Diffused Metal Oxide Semiconductor
PAR	Peak-to-Average power Ratio
PDPCH	transmission Power of the Dedicated Physical CHannel
PHS	Personal Handy-phone System
RF	Radio Frequency
VSWR	Voltage Standing Wave Ratio
W-CDMA	Wideband Code Division Multiple Access

10. Revision history

Table 10. Revision history

Document ID	Release date	Data sheet status	Change notice	Supersedes
BLF6G21-10G_2	20091211	Product data sheet	-	BLF6G21-10G_1
Modifications:	<ul style="list-style-type: none"> • Section 6 on page 3: added some values. • Table 7 on page 3: added some values. • Section 7.1 on page 3: added some values. • Section 7.2 on page 4: added CW powersweeps. • Section 7.3 on page 5: added 1-carrier W-CDMA powersweeps. • Section 7.4 on page 6: added 2-carrier W-CDMA powersweeps. 			
BLF6G21-10G_1	20090511	Objective data sheet	-	-

11. Legal information

11.1 Data sheet status

Document status ^{[1][2]}	Product status ^[3]	Definition
Objective [short] data sheet	Development	This document contains data from the objective specification for product development.
Preliminary [short] data sheet	Qualification	This document contains data from the preliminary specification.
Product [short] data sheet	Production	This document contains the product specification.

[1] Please consult the most recently issued document before initiating or completing a design.

[2] The term 'short data sheet' is explained in section "Definitions".

[3] The product status of device(s) described in this document may have changed since this document was published and may differ in case of multiple devices. The latest product status information is available on the Internet at URL <http://www.nxp.com>.

11.2 Definitions

Draft — The document is a draft version only. The content is still under internal review and subject to formal approval, which may result in modifications or additions. NXP Semiconductors does not give any representations or warranties as to the accuracy or completeness of information included herein and shall have no liability for the consequences of use of such information.

Short data sheet — A short data sheet is an extract from a full data sheet with the same product type number(s) and title. A short data sheet is intended for quick reference only and should not be relied upon to contain detailed and full information. For detailed and full information see the relevant full data sheet, which is available on request via the local NXP Semiconductors sales office. In case of any inconsistency or conflict with the short data sheet, the full data sheet shall prevail.

11.3 Disclaimers

General — Information in this document is believed to be accurate and reliable. However, NXP Semiconductors does not give any representations or warranties, expressed or implied, as to the accuracy or completeness of such information and shall have no liability for the consequences of use of such information.

Right to make changes — NXP Semiconductors reserves the right to make changes to information published in this document, including without limitation specifications and product descriptions, at any time and without notice. This document supersedes and replaces all information supplied prior to the publication hereof.

Suitability for use — NXP Semiconductors products are not designed, authorized or warranted to be suitable for use in medical, military, aircraft, space or life support equipment, nor in applications where failure or malfunction of an NXP Semiconductors product can reasonably be expected to result in personal injury, death or severe property or environmental

damage. NXP Semiconductors accepts no liability for inclusion and/or use of NXP Semiconductors products in such equipment or applications and therefore such inclusion and/or use is at the customer's own risk.

Applications — Applications that are described herein for any of these products are for illustrative purposes only. NXP Semiconductors makes no representation or warranty that such applications will be suitable for the specified use without further testing or modification.

Limiting values — Stress above one or more limiting values (as defined in the Absolute Maximum Ratings System of IEC 60134) may cause permanent damage to the device. Limiting values are stress ratings only and operation of the device at these or any other conditions above those given in the Characteristics sections of this document is not implied. Exposure to limiting values for extended periods may affect device reliability.

Terms and conditions of sale — NXP Semiconductors products are sold subject to the general terms and conditions of commercial sale, as published at <http://www.nxp.com/profile/terms>, including those pertaining to warranty, intellectual property rights infringement and limitation of liability, unless explicitly otherwise agreed to in writing by NXP Semiconductors. In case of any inconsistency or conflict between information in this document and such terms and conditions, the latter will prevail.

No offer to sell or license — Nothing in this document may be interpreted or construed as an offer to sell products that is open for acceptance or the grant, conveyance or implication of any license under any copyrights, patents or other industrial or intellectual property rights.

Export control — This document as well as the item(s) described herein may be subject to export control regulations. Export might require a prior authorization from national authorities.

11.4 Trademarks

Notice: All referenced brands, product names, service names and trademarks are the property of their respective owners.

12. Contact information

For more information, please visit: <http://www.nxp.com>

For sales office addresses, please send an email to: salesaddresses@nxp.com

13. Contents

1 Product profile 1

1.1 General description 1

1.2 Features 1

1.3 Applications 2

2 Pinning information 2

3 Ordering information 2

4 Limiting values 2

5 Thermal characteristics 3

6 Characteristics 3

7 Application information 3

7.1 Ruggedness in class-AB operation 3

7.2 CW 4

7.3 1-carrier W-CDMA 5

7.4 2-carrier W-CDMA 6

8 Package outline 8

9 Abbreviations 9

10 Revision history 9

11 Legal information 10

11.1 Data sheet status 10

11.2 Definitions 10

11.3 Disclaimers 10

11.4 Trademarks 10

12 Contact information 10

13 Contents 11

Please be aware that important notices concerning this document and the product(s) described herein, have been included in section 'Legal information'.



© NXP B.V. 2009.

All rights reserved.

For more information, please visit: <http://www.nxp.com>

For sales office addresses, please send an email to: salesaddresses@nxp.com

Date of release: 11 December 2009

Document identifier: BLF6G21-10G_2