

PMEG3020BER

2 A low V_F MEGA Schottky barrier rectifier

Rev. 01 — 16 April 2009

Product data sheet

1. Product profile

1.1 General description

Planar Maximum Efficiency General Application (MEGA) Schottky barrier rectifier with an integrated guard ring for stress protection, encapsulated in a SOD123W small and flat lead Surface-Mounted Device (SMD) plastic package.

1.2 Features

- Average forward current: $I_{F(AV)} \leq 2$ A
- Reverse voltage: $V_R \leq 30$ V
- Low forward voltage
- High power capability due to clip-bond technology
- AEC-Q101 qualified
- Small and flat lead SMD plastic package

1.3 Applications

- Low voltage rectification
- High efficiency DC-to-DC conversion
- Switch Mode Power Supply (SMPS)
- Reverse polarity protection
- Low power consumption applications

1.4 Quick reference data

Table 1. Quick reference data



$T_j = 25$ °C unless otherwise specified.

Symbol	Parameter	Conditions	Min	Typ	Max	Unit
$I_{F(AV)}$	average forward current	square wave; $\delta = 0.5$; $f = 20$ kHz				
		$T_{amb} \leq 75$ °C	[1]	-	2	A
		$T_{sp} \leq 135$ °C	-	-	2	A
V_R	reverse voltage		-	-	30	V
V_F	forward voltage	$I_F = 2$ A	-	460	520	mV
I_R	reverse current	$V_R = 30$ V	-	15	50	μ A

[1] Device mounted on a ceramic Printed-Circuit Board (PCB), Al_2O_3 , standard footprint.

2. Pinning information

Table 2. Pinning

Pin	Description	Simplified outline	Graphic symbol
1	cathode	[1]	1  2
2	anode		sym001

[1] The marking bar indicates the cathode.

3. Ordering information

Table 3. Ordering information

Type number	Package		
	Name	Description	Version
PMEG3020BER	-	plastic surface-mounted package; 2 leads	SOD123W

4. Marking

Table 4. Marking codes

Type number	Marking code
PMEG3020BER	BA

5. Limiting values

Table 5. Limiting values

In accordance with the Absolute Maximum Rating System (IEC 60134).

Symbol	Parameter	Conditions	Min	Max	Unit
V_R	reverse voltage	$T_j = 25\text{ °C}$	-	30	V
$I_{F(AV)}$	average forward current	square wave; $\delta = 0.5$; $f = 20\text{ kHz}$			
		$T_{amb} \leq 75\text{ °C}$	[1] -	2	A
		$T_{sp} \leq 135\text{ °C}$	-	2	A
I_{FSM}	non-repetitive peak forward current	square wave; $t_p = 8\text{ ms}$	[2] -	50	A
P_{tot}	total power dissipation	$T_{amb} \leq 25\text{ °C}$	[3][4] -	0.57	W
			[3][5] -	0.95	W
			[3][1] -	1.8	W

Table 5. Limiting values ...continued
In accordance with the Absolute Maximum Rating System (IEC 60134).

Symbol	Parameter	Conditions	Min	Max	Unit
T_j	junction temperature		-	150	°C
T_{amb}	ambient temperature		-55	+150	°C
T_{stg}	storage temperature		-65	+150	°C

- [1] Device mounted on a ceramic PCB, Al₂O₃, standard footprint.
- [2] $T_j = 25$ °C prior to surge.
- [3] Reflow soldering is the only recommended soldering method.
- [4] Device mounted on an FR4 PCB, single-sided copper, tin-plated and standard footprint.
- [5] Device mounted on an FR4 PCB, single-sided copper, tin-plated, mounting pad for cathode 1 cm².

6. Thermal characteristics

Table 6. Thermal characteristics

Symbol	Parameter	Conditions	Min	Typ	Max	Unit	
$R_{th(j-a)}$	thermal resistance from junction to ambient	in free air	[1][2]				
			[3]	-	-	220	K/W
			[4]	-	-	130	K/W
			[5]	-	-	70	K/W
$R_{th(j-sp)}$	thermal resistance from junction to solder point		[6]	-	-	18	K/W

- [1] For Schottky barrier diodes thermal runaway has to be considered, as in some applications the reverse power losses P_R are a significant part of the total power losses.
- [2] Reflow soldering is the only recommended soldering method.
- [3] Device mounted on an FR4 PCB, single-sided copper, tin-plated and standard footprint.
- [4] Device mounted on an FR4 PCB, single-sided copper, tin-plated, mounting pad for cathode 1 cm².
- [5] Device mounted on a ceramic PCB, Al₂O₃, standard footprint.
- [6] Soldering point of cathode tab.

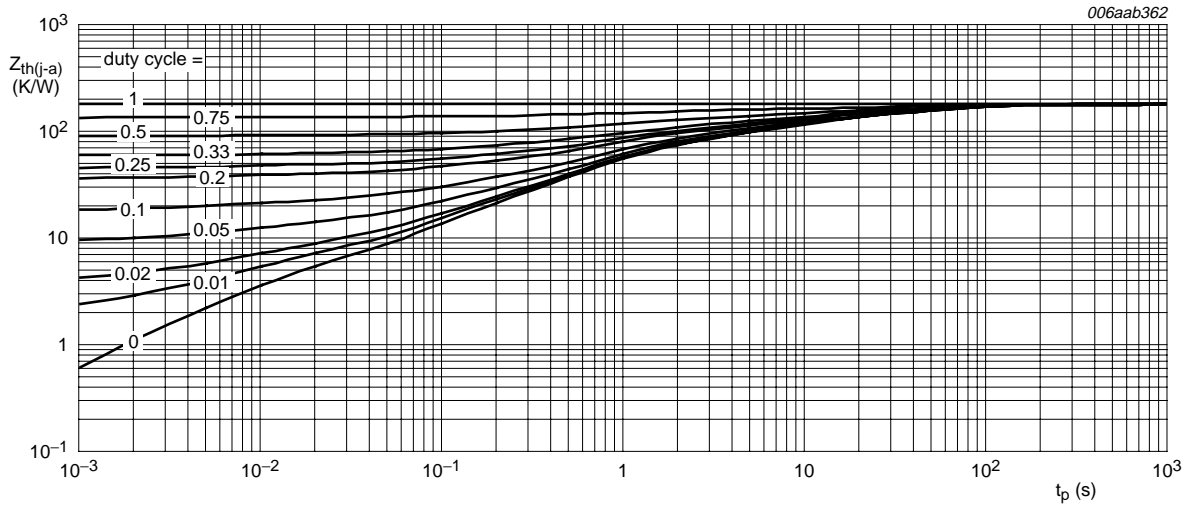

FR4 PCB, standard footprint

Fig 1. Transient thermal impedance from junction to ambient as a function of pulse duration; typical values

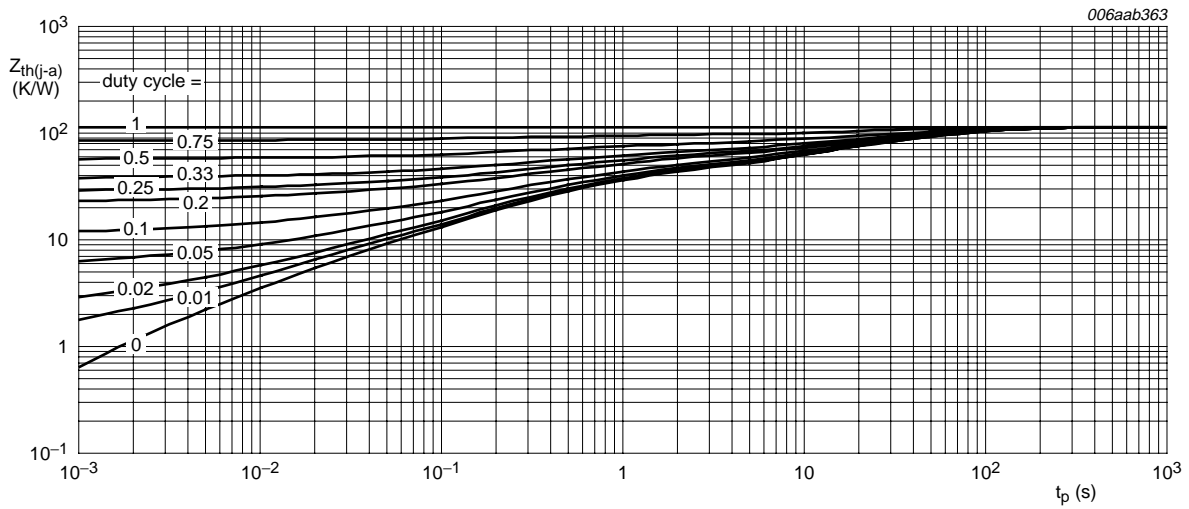

FR4 PCB, mounting pad for cathode 1 cm²

Fig 2. Transient thermal impedance from junction to ambient as a function of pulse duration; typical values

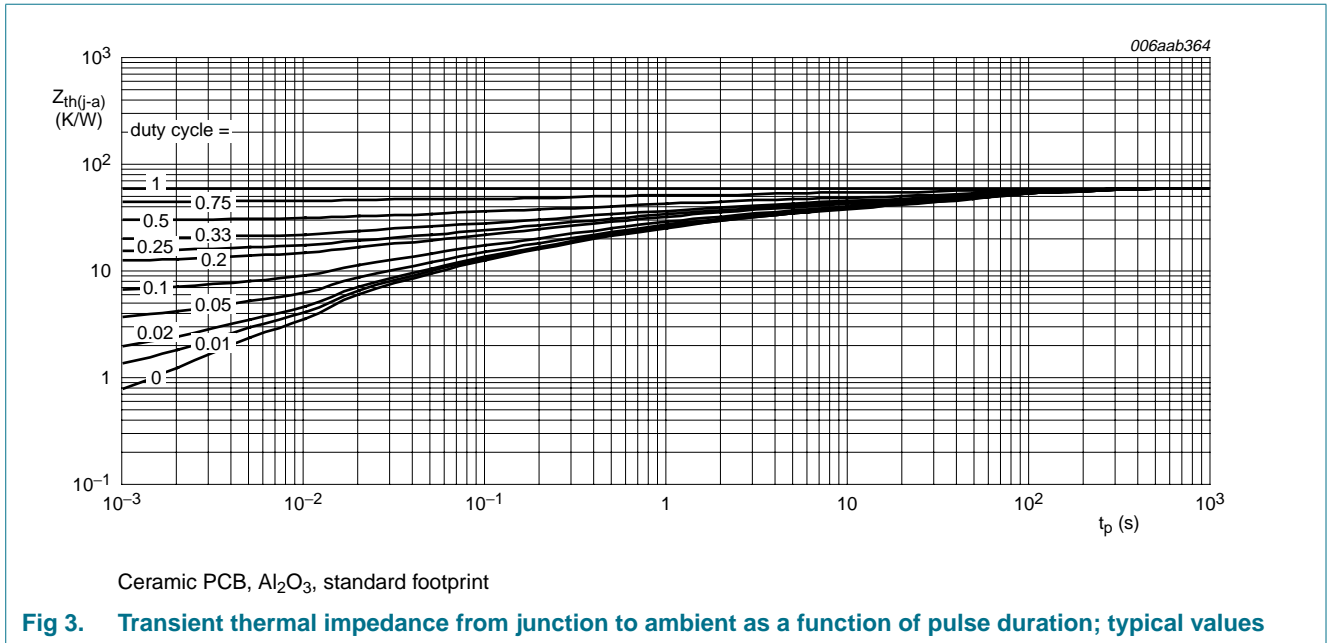

7. Characteristics

Table 7. Characteristics
 $T_j = 25^\circ\text{C}$ unless otherwise specified.

Symbol	Parameter	Conditions	Min	Typ	Max	Unit
V_F	forward voltage	$I_F = 0.1\text{ A}$	-	315	360	mV
		$I_F = 0.7\text{ A}$	-	390	430	mV
		$I_F = 1\text{ A}$	-	405	450	mV
		$I_F = 1.5\text{ A}$	-	430	480	mV
		$I_F = 2\text{ A}$	-	460	520	mV
I_R	reverse current	$V_R = 5\text{ V}$	-	2	-	μA
		$V_R = 10\text{ V}$	-	3	-	μA
		$V_R = 30\text{ V}$	-	15	50	μA
C_d	diode capacitance	$f = 1\text{ MHz}$				
		$V_R = 1\text{ V}$	-	170	-	pF
		$V_R = 10\text{ V}$	-	60	-	pF

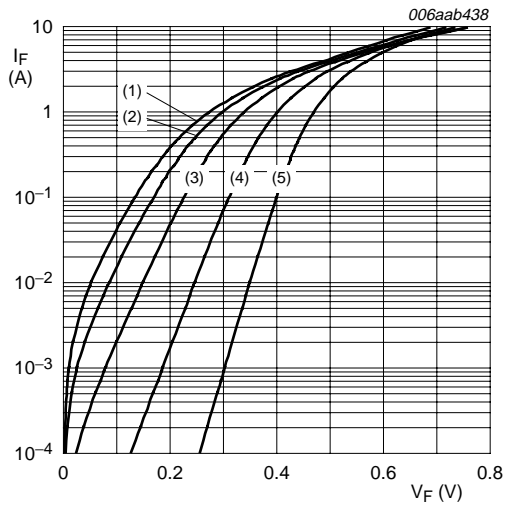

- (1) $T_j = 150\text{ °C}$
- (2) $T_j = 125\text{ °C}$
- (3) $T_j = 85\text{ °C}$
- (4) $T_j = 25\text{ °C}$
- (5) $T_j = -40\text{ °C}$

Fig 4. Forward current as a function of forward voltage; typical values

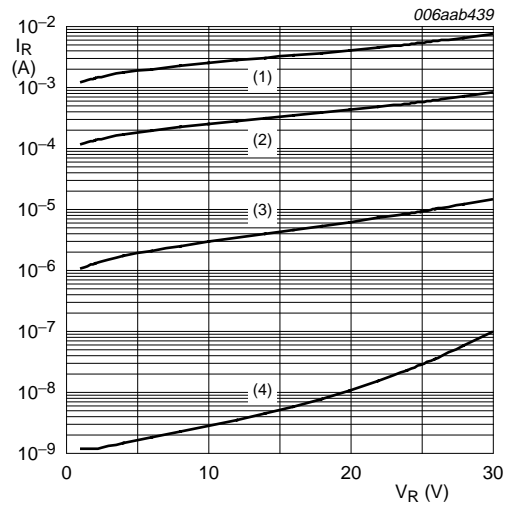

- (1) $T_j = 125\text{ °C}$
- (2) $T_j = 85\text{ °C}$
- (3) $T_j = 25\text{ °C}$
- (4) $T_j = -40\text{ °C}$

Fig 5. Reverse current as a function of reverse voltage; typical values

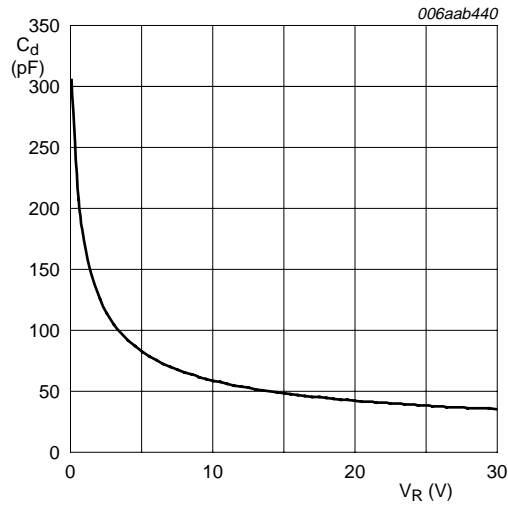

$f = 1\text{ MHz}; T_{amb} = 25\text{ °C}$

Fig 6. Diode capacitance as a function of reverse voltage; typical values

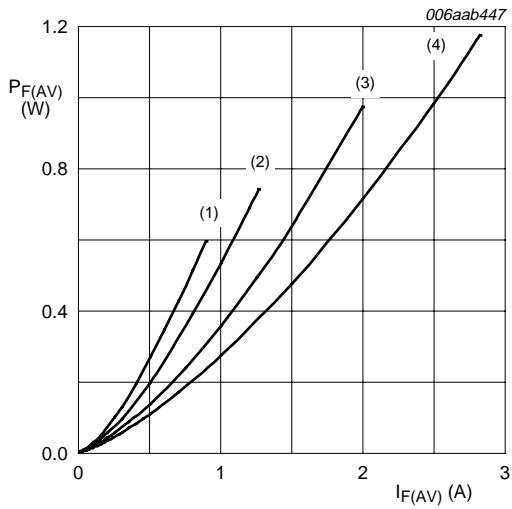

- $T_j = 150\text{ °C}$
- (1) $\delta = 0.1$
 - (2) $\delta = 0.2$
 - (3) $\delta = 0.5$
 - (4) $\delta = 1$

Fig 7. Average forward power dissipation as a function of average forward current; typical values

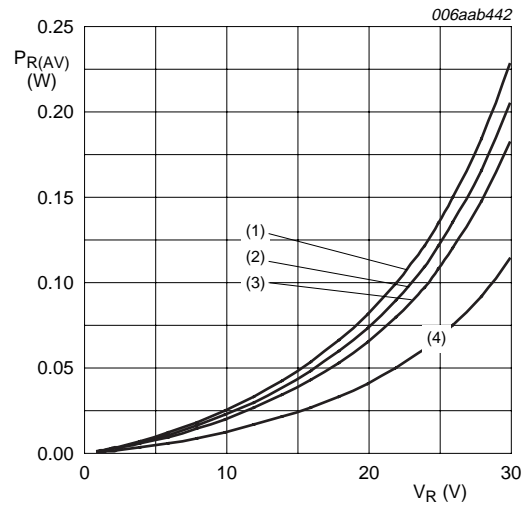

- $T_j = 125\text{ °C}$
- (1) $\delta = 1$
 - (2) $\delta = 0.9$
 - (3) $\delta = 0.8$
 - (4) $\delta = 0.5$

Fig 8. Average reverse power dissipation as a function of reverse voltage; typical values

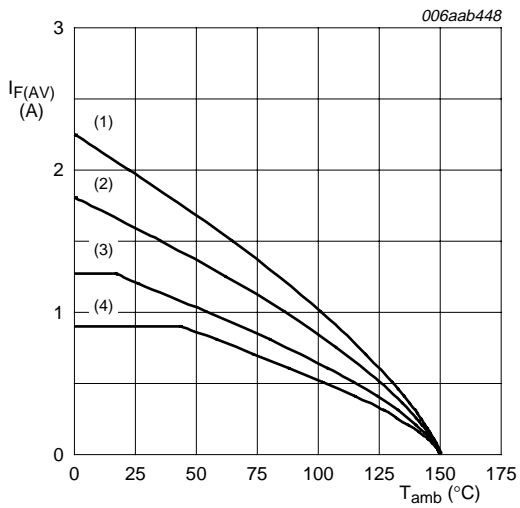

- FR4 PCB, standard footprint
 $T_j = 150\text{ °C}$
- (1) $\delta = 1$; DC
 - (2) $\delta = 0.5$; $f = 20\text{ kHz}$
 - (3) $\delta = 0.2$; $f = 20\text{ kHz}$
 - (4) $\delta = 0.1$; $f = 20\text{ kHz}$

Fig 9. Average forward current as a function of ambient temperature; typical values

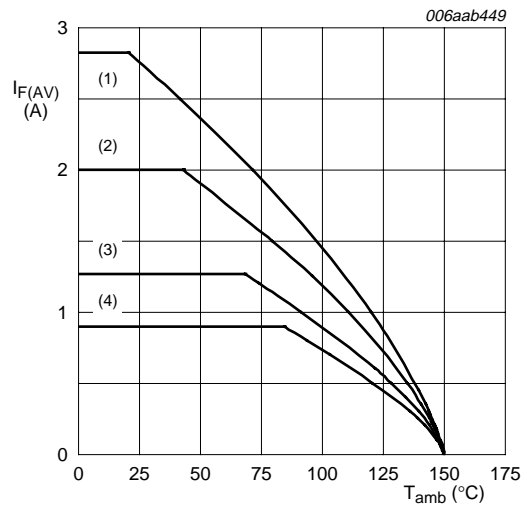

- FR4 PCB, mounting pad for cathode 1 cm^2
 $T_j = 150\text{ °C}$
- (1) $\delta = 1$; DC
 - (2) $\delta = 0.5$; $f = 20\text{ kHz}$
 - (3) $\delta = 0.2$; $f = 20\text{ kHz}$
 - (4) $\delta = 0.1$; $f = 20\text{ kHz}$

Fig 10. Average forward current as a function of ambient temperature; typical values

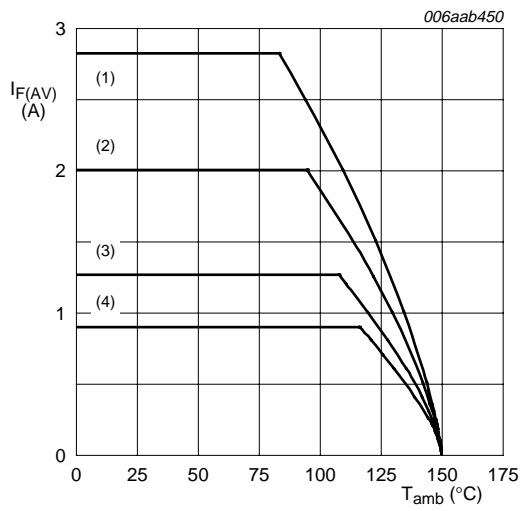

Ceramic PCB, Al_2O_3 , standard footprint
 $T_j = 150\text{ °C}$
 (1) $\delta = 1$; DC
 (2) $\delta = 0.5$; $f = 20\text{ kHz}$
 (3) $\delta = 0.2$; $f = 20\text{ kHz}$
 (4) $\delta = 0.1$; $f = 20\text{ kHz}$

Fig 11. Average forward current as a function of ambient temperature; typical values

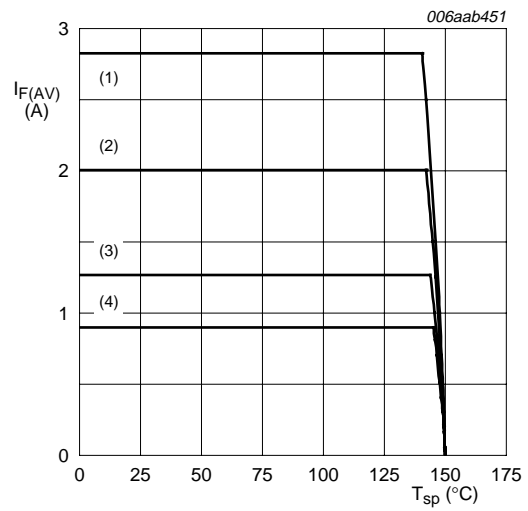

$T_j = 150\text{ °C}$
 (1) $\delta = 1$; DC
 (2) $\delta = 0.5$; $f = 20\text{ kHz}$
 (3) $\delta = 0.2$; $f = 20\text{ kHz}$
 (4) $\delta = 0.1$; $f = 20\text{ kHz}$

Fig 12. Average forward current as a function of solder point temperature; typical values

8. Test information

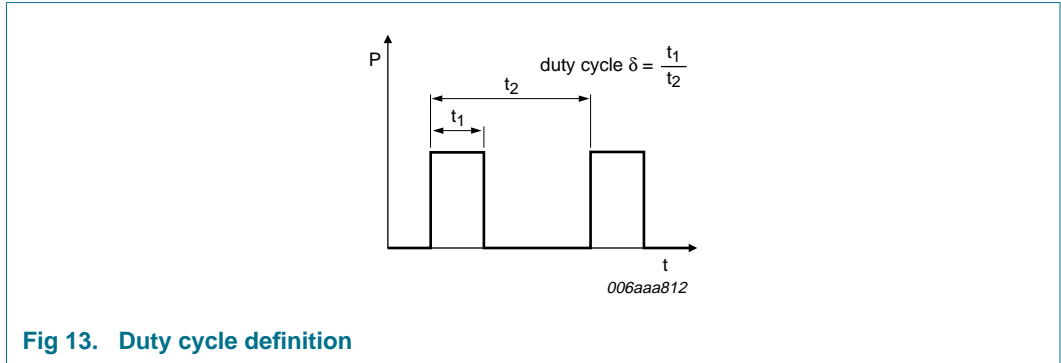

Fig 13. Duty cycle definition

The current ratings for the typical waveforms as shown in [Figure 9](#), [10](#), [11](#) and [12](#) are calculated according to the equations: $I_{F(AV)} = I_M \times \delta$ with I_M defined as peak current, $I_{RMS} = I_{F(AV)}$ at DC, and $I_{RMS} = I_M \times \sqrt{\delta}$ with I_{RMS} defined as RMS current.

8.1 Quality information

This product has been qualified in accordance with the Automotive Electronics Council (AEC) standard *Q101 - Stress test qualification for discrete semiconductors*, and is suitable for use in automotive applications.

9. Package outline

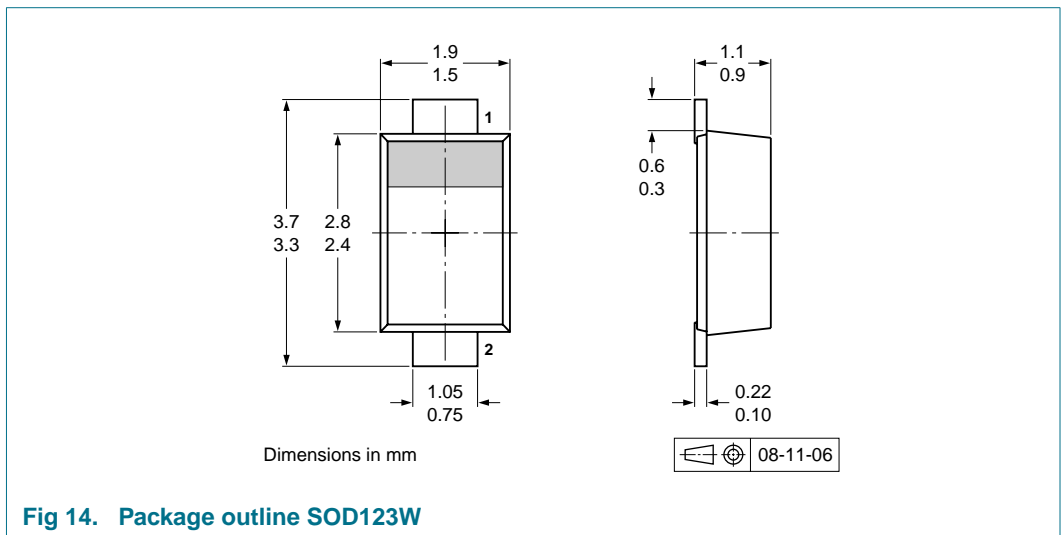

Fig 14. Package outline SOD123W

10. Packing information

Table 8. Packing methods

The indicated -xxx are the last three digits of the 12NC ordering code.^[1]

Type number	Package	Description	Packing quantity
			3000
PMEG3020BER	SOD123W	4 mm pitch, 8 mm tape and reel	-115

[1] For further information and the availability of packing methods, see [Section 14](#).

11. Soldering

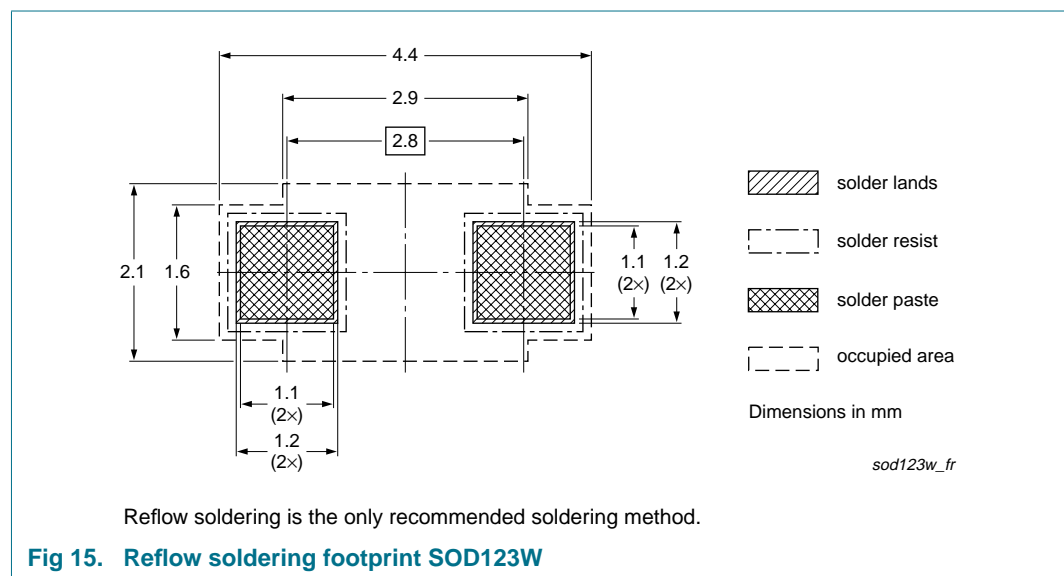

12. Revision history

Table 9. Revision history

Document ID	Release date	Data sheet status	Change notice	Supersedes
PMEG3020BER_1	20090416	Product data sheet	-	-

13. Legal information

13.1 Data sheet status

Document status ^{[1][2]}	Product status ^[3]	Definition
Objective [short] data sheet	Development	This document contains data from the objective specification for product development.
Preliminary [short] data sheet	Qualification	This document contains data from the preliminary specification.
Product [short] data sheet	Production	This document contains the product specification.

[1] Please consult the most recently issued document before initiating or completing a design.

[2] The term 'short data sheet' is explained in section "Definitions".

[3] The product status of device(s) described in this document may have changed since this document was published and may differ in case of multiple devices. The latest product status information is available on the Internet at URL <http://www.nxp.com>.

13.2 Definitions

Draft — The document is a draft version only. The content is still under internal review and subject to formal approval, which may result in modifications or additions. NXP Semiconductors does not give any representations or warranties as to the accuracy or completeness of information included herein and shall have no liability for the consequences of use of such information.

Short data sheet — A short data sheet is an extract from a full data sheet with the same product type number(s) and title. A short data sheet is intended for quick reference only and should not be relied upon to contain detailed and full information. For detailed and full information see the relevant full data sheet, which is available on request via the local NXP Semiconductors sales office. In case of any inconsistency or conflict with the short data sheet, the full data sheet shall prevail.

13.3 Disclaimers

General — Information in this document is believed to be accurate and reliable. However, NXP Semiconductors does not give any representations or warranties, expressed or implied, as to the accuracy or completeness of such information and shall have no liability for the consequences of use of such information.

Right to make changes — NXP Semiconductors reserves the right to make changes to information published in this document, including without limitation specifications and product descriptions, at any time and without notice. This document supersedes and replaces all information supplied prior to the publication hereof.

Suitability for use — NXP Semiconductors products are not designed, authorized or warranted to be suitable for use in medical, military, aircraft, space or life support equipment, nor in applications where failure or malfunction of an NXP Semiconductors product can reasonably be expected to result in personal injury, death or severe property or environmental

damage. NXP Semiconductors accepts no liability for inclusion and/or use of NXP Semiconductors products in such equipment or applications and therefore such inclusion and/or use is at the customer's own risk.

Applications — Applications that are described herein for any of these products are for illustrative purposes only. NXP Semiconductors makes no representation or warranty that such applications will be suitable for the specified use without further testing or modification.

Limiting values — Stress above one or more limiting values (as defined in the Absolute Maximum Ratings System of IEC 60134) may cause permanent damage to the device. Limiting values are stress ratings only and operation of the device at these or any other conditions above those given in the Characteristics sections of this document is not implied. Exposure to limiting values for extended periods may affect device reliability.

Terms and conditions of sale — NXP Semiconductors products are sold subject to the general terms and conditions of commercial sale, as published at <http://www.nxp.com/profile/terms>, including those pertaining to warranty, intellectual property rights infringement and limitation of liability, unless explicitly otherwise agreed to in writing by NXP Semiconductors. In case of any inconsistency or conflict between information in this document and such terms and conditions, the latter will prevail.

No offer to sell or license — Nothing in this document may be interpreted or construed as an offer to sell products that is open for acceptance or the grant, conveyance or implication of any license under any copyrights, patents or other industrial or intellectual property rights.

Quick reference data — The Quick reference data is an extract of the product data given in the Limiting values and Characteristics sections of this document, and as such is not complete, exhaustive or legally binding.

Export control — This document as well as the item(s) described herein may be subject to export control regulations. Export might require a prior authorization from national authorities.

13.4 Trademarks

Notice: All referenced brands, product names, service names and trademarks are the property of their respective owners.

14. Contact information

For more information, please visit: <http://www.nxp.com>

For sales office addresses, please send an email to: salesaddresses@nxp.com

15. Contents

1 Product profile 1

1.1 General description 1

1.2 Features 1

1.3 Applications 1

1.4 Quick reference data 1

2 Pinning information 2

3 Ordering information 2

4 Marking 2

5 Limiting values 2

6 Thermal characteristics 3

7 Characteristics 5

8 Test information 9

8.1 Quality information 9

9 Package outline 9

10 Packing information 10

11 Soldering 10

12 Revision history 11

13 Legal information 12

13.1 Data sheet status 12

13.2 Definitions 12

13.3 Disclaimers 12

13.4 Trademarks 12

14 Contact information 12

15 Contents 13

Please be aware that important notices concerning this document and the product(s) described herein, have been included in section 'Legal information'.

