

1. Overview

1.1 Features

The R8C/2E Group and R8C/2F Group of single-chip MCUs incorporates the R8C/Tiny Series CPU core, employing sophisticated instructions for a high level of efficiency. With 1 Mbyte of address space, and it is capable of executing instructions at high speed. In addition, the CPU core boasts a multiplier for high-speed operation processing.

Power consumption is low, and the supported operating modes allow additional power control. These MCUs also use an anti-noise configuration to reduce emissions of electromagnetic noise and are designed to withstand EMI.

Integration of many peripheral functions, including multifunction timer and serial interface, reduces the number of system components.

Furthermore, the R8C/2F Group has on-chip data flash (1 KB × 2 blocks).

The difference between the R8C/2E Group and R8C/2F Group is only the presence or absence of data flash. Their peripheral functions are the same.

1.1.1 Applications

Electronic household appliances, office equipment, audio equipment, consumer equipment, etc.

1.1.2 Specifications

Tables 1.1 and 1.2 outlines the Specifications for R8C/2E Group and Tables 1.3 and 1.4 outlines the Specifications for R8C/2F Group.

Table 1.1 Specifications for R8C/2E Group (1)

Item	Function	Specification
CPU	Central processing unit	R8C/Tiny series core <ul style="list-style-type: none"> • Number of fundamental instructions: 89 • Minimum instruction execution time: <ul style="list-style-type: none"> 50 ns (f(XIN) = 20 MHz, VCC = 3.0 to 5.5 V) 100 ns (f(XIN) = 10 MHz, VCC = 2.7 to 5.5 V) • Multiplier: 16 bits × 16 bits → 32 bits • Multiply-accumulate instruction: 16 bits × 16 bits + 32 bits → 32 bits • Operation mode: Single-chip mode (address space: 1 Mbyte)
Memory	ROM, RAM	Refer to Table 1.5 Product List for R8C/2E Group .
Power Supply Voltage Detection	Voltage detection circuit	<ul style="list-style-type: none"> • Power-on reset • Voltage detection 2
I/O Ports	Programmable I/O ports	<ul style="list-style-type: none"> • Input-only: 3 pins • CMOS I/O ports: 25, selectable pull-up resistor • High current drive ports: 8
Clock	Clock generation circuits	2 circuits: XIN clock oscillation circuit (with on-chip feedback resistor), On-chip oscillator (high-speed, low-speed) (high-speed on-chip oscillator has a frequency adjustment function) <ul style="list-style-type: none"> • Oscillation stop detection: XIN clock oscillation stop detection function • Frequency divider circuit: Dividing selectable 1, 2, 4, 8, and 16 • Low power consumption modes: <ul style="list-style-type: none"> Standard operating mode (high-speed clock, high-speed on-chip oscillator, low-speed on-chip oscillator), wait mode, stop mode
Interrupts		<ul style="list-style-type: none"> • External: 4 sources, Internal: 13 sources, Software: 4 sources • Priority levels: 7 levels
Watchdog Timer		15 bits × 1 (with prescaler), reset start selectable
Timer	Timer RA	8 bits × 1 (with 8-bit prescaler) Timer mode (period timer), pulse output mode (output level inverted every period), event counter mode, pulse width measurement mode, pulse period measurement mode
	Timer RB	8 bits × 1 (with 8-bit prescaler) Timer mode (period timer), programmable waveform generation mode (PWM output), programmable one-shot generation mode, programmable wait one-shot generation mode
	Timer RC	16 bits × 1 (with 4 capture/compare registers) Timer mode (input capture function, output compare function), PWM mode (output 3 pins), PWM2 mode (PWM output pin)
	Timer RE	8 bits × 1 Output compare mode
Serial Interface	UART0	Clock synchronous serial I/O/UART × 1
LIN Module		Hardware LIN: 1 (timer RA, UART0)
A/D Converter		10-bit resolution × 12 channels, includes sample and hold function
D/A Converter		8-bit resolution × 2 circuits
Comparator		2 circuits

Table 1.2 Specifications for R8C/2E Group (2)

Item	Specification
Flash Memory	<ul style="list-style-type: none"> • Programming and erasure voltage: VCC = 2.7 to 5.5 V • Programming and erasure endurance: 100 times • Program security: ROM code protect, ID code check • Debug functions: On-chip debug, on-board flash rewrite function
Operating Frequency/Supply Voltage	f(XIN) = 20 MHz (VCC = 3.0 to 5.5 V), f(XIN) = 10 MHz (VCC = 2.7 to 5.5 V)
Current consumption	Typ. 10 mA (VCC = 5.0 V, f(XIN) = 20 MHz) Typ. 6 mA (VCC = 3.0 V, f(XIN) = 10 MHz) Typ. 23 μ A (VCC = 3.0 V, wait mode (peripheral clock off)) Typ. 0.7 μ A (VCC = 3.0 V, stop mode)
Operating Ambient Temperature	-20 to 85°C (N version) -40 to 85°C (D version) ⁽¹⁾
Package	32-pin LQFP Package code: PLQP0032GB-A (previous code: 32P6U-A)

NOTE:

1. Specify the D version if D version functions are to be used.

Table 1.3 Specifications for R8C/2F Group (1)

Item	Function	Specification
CPU	Central processing unit	R8C/Tiny series core <ul style="list-style-type: none"> • Number of fundamental instructions: 89 • Minimum instruction execution time: <ul style="list-style-type: none"> 50 ns (f(XIN) = 20 MHz, VCC = 3.0 to 5.5 V) 100 ns (f(XIN) = 10 MHz, VCC = 2.7 to 5.5 V) • Multiplier: 16 bits × 16 bits → 32 bits • Multiply-accumulate instruction: 16 bits × 16 bits + 32 bits → 32 bits • Operation mode: Single-chip mode (address space: 1 Mbyte)
Memory	ROM, RAM	Refer to Table 1.6 Product List for R8C/2F Group .
Power Supply Voltage Detection	Voltage detection circuit	<ul style="list-style-type: none"> • Power-on reset • Voltage detection 2
I/O Ports	Programmable I/O ports	<ul style="list-style-type: none"> • Input-only: 3 pins • CMOS I/O ports: 25, selectable pull-up resistor • High current drive ports: 8
Clock	Clock generation circuits	<p>2 circuits: XIN clock oscillation circuit (with on-chip feedback resistor), On-chip oscillator (high-speed, low-speed) (high-speed on-chip oscillator has a frequency adjustment function)</p> <ul style="list-style-type: none"> • Oscillation stop detection: XIN clock oscillation stop detection function • Frequency divider circuit: Dividing selectable 1, 2, 4, 8, and 16 • Low power consumption modes: <ul style="list-style-type: none"> Standard operating mode (high-speed clock, high-speed on-chip oscillator, low-speed on-chip oscillator), wait mode, stop mode
Interrupts		<ul style="list-style-type: none"> • External: 4 sources, Internal: 13 sources, Software: 4 sources • Priority levels: 7 levels
Watchdog Timer		15 bits × 1 (with prescaler), reset start selectable
Timer	Timer RA	8 bits × 1 (with 8-bit prescaler) Timer mode (period timer), pulse output mode (output level inverted every period), event counter mode, pulse width measurement mode, pulse period measurement mode
	Timer RB	8 bits × 1 (with 8-bit prescaler) Timer mode (period timer), programmable waveform generation mode (PWM output), programmable one-shot generation mode, programmable wait one-shot generation mode
	Timer RC	16 bits × 1 (with 4 capture/compare registers) Timer mode (input capture function, output compare function), PWM mode (output 3 pins), PWM2 mode (PWM output pin)
	Timer RE	8 bits × 1 Output compare mode
Serial Interface	UART0	Clock synchronous serial I/O/UART × 1
LIN Module		Hardware LIN: 1 (timer RA, UART0)
A/D Converter		10-bit resolution × 12 channels, includes sample and hold function
D/A Converter		8-bit resolution × 2 circuits
Comparator		2 circuits

Table 1.4 Specifications for R8C/2F Group (2)

Item	Specification
Flash Memory	<ul style="list-style-type: none"> • Programming and erasure voltage: VCC = 2.7 to 5.5 V • Programming and erasure endurance: 10,000 times (data flash) 1,000 times (program ROM) • Program security: ROM code protect, ID code check • Debug functions: On-chip debug, on-board flash rewrite function
Operating Frequency/Supply Voltage	f(XIN) = 20 MHz (VCC = 3.0 to 5.5 V), f(XIN) = 10 MHz (VCC = 2.7 to 5.5 V)
Current consumption	Typ. 10 mA (VCC = 5.0 V, f(XIN) = 20 MHz) Typ. 6 mA (VCC = 3.0 V, f(XIN) = 10 MHz) Typ. 23 μ A (VCC = 3.0 V, wait mode (peripheral clock off)) Typ. 0.7 μ A (VCC = 3.0 V, stop mode)
Operating Ambient Temperature	-20 to 85°C (N version) -40 to 85°C (D version) ⁽¹⁾
Package	32-pin LQFP Package code: PLQP0032GB-A (previous code: 32P6U-A)

NOTE:

1. Specify the D version if D version functions are to be used.

1.2 Product List

Table 1.5 lists Product List for R8C/2E Group, Figure 1.1 shows a Part Number, Memory Size, and Package of R8C/2E Group, Table 1.6 lists Product List for R8C/2F Group, and Figure 1.2 shows a Part Number, Memory Size, and Package of R8C/2F Group.

Table 1.5 Product List for R8C/2E Group **Current of Dec. 2007**

Part No.	ROM Capacity	RAM Capacity	Package Type	Remarks
R5F212E2NFP	8 Kbytes	512 bytes	PLQP0032GB-A	N version
R5F212E4NFP	16 Kbytes	1 Kbyte	PLQP0032GB-A	
R5F212E2DFP	8 Kbytes	512 bytes	PLQP0032GB-A	D version
R5F212E4DFP	16 Kbytes	1 Kbyte	PLQP0032GB-A	
R5F212E2NXXXFP	8 Kbytes	512 bytes	PLQP0032GB-A	N version Factory programming product ⁽¹⁾
R5F212E4NXXXFP	16 Kbytes	1 Kbyte	PLQP0032GB-A	
R5F212E2DXXXFP	8 Kbytes	512 bytes	PLQP0032GB-A	D version Factory programming product ⁽¹⁾
R5F212E4DXXXFP	16 Kbytes	1 Kbyte	PLQP0032GB-A	

NOTE:

1. The user ROM is programmed before shipment.

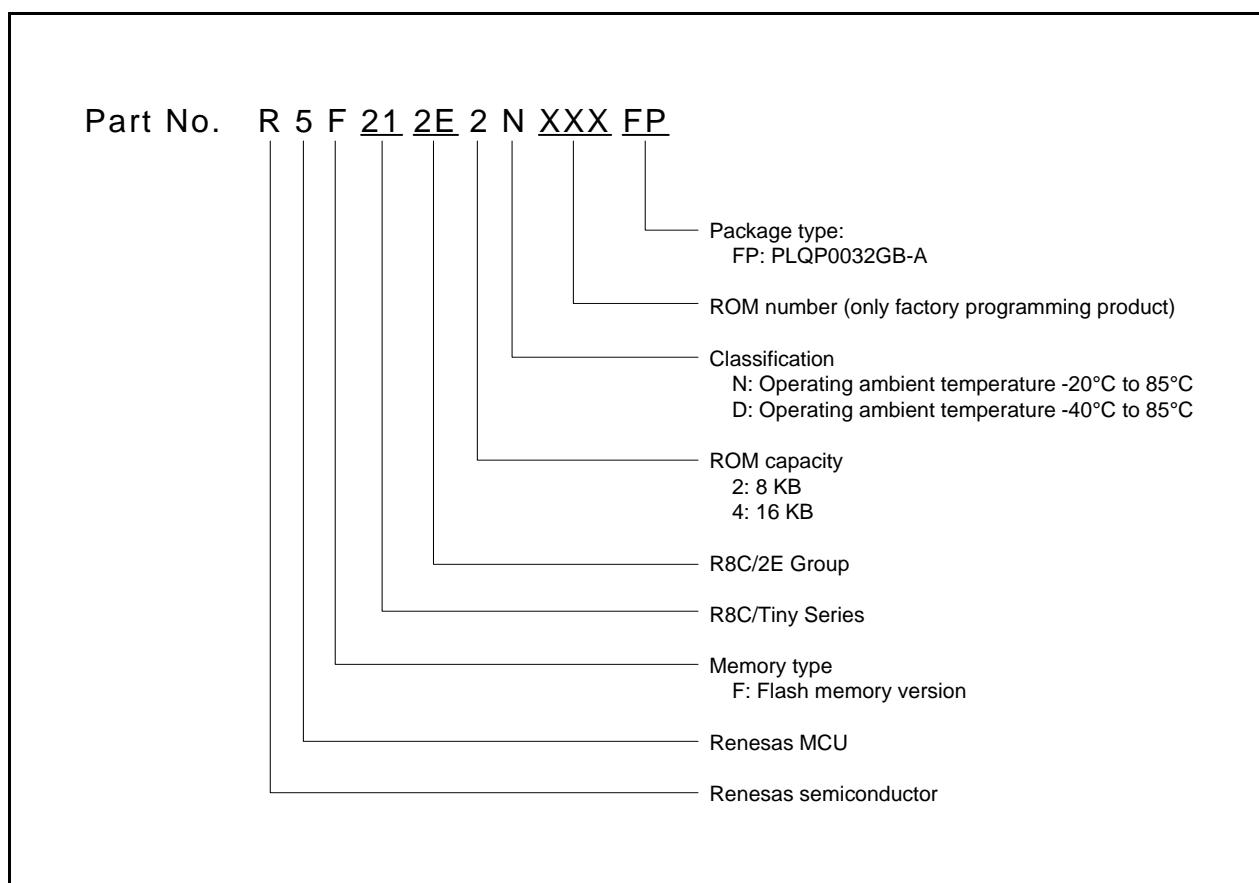

Figure 1.1 Part Number, Memory Size, and Package of R8C/2E Group

Table 1.6 Product List for R8C/2F Group **Current of Dec. 2007**

Part No.	ROM Capacity		RAM Capacity	Package Type	Remarks
	Program ROM	Data flash			
R5F212F2NFP	8 Kbytes	1 Kbyte x 2	512 bytes	PLQP0032GB-A	N version
R5F212F4NFP	16 Kbytes	1 Kbyte x 2	1 Kbyte	PLQP0032GB-A	
R5F212F2DFP	8 Kbytes	1 Kbyte x 2	512 bytes	PLQP0032GB-A	D version
R5F212F4DFP	16 Kbytes	1 Kbyte x 2	1 Kbyte	PLQP0032GB-A	
R5F212F2NXXXFP	8 Kbytes	1 Kbyte x 2	512 bytes	PLQP0032GB-A	N version
R5F212F4NXXXFP	16 Kbytes	1 Kbyte x 2	1 Kbyte	PLQP0032GB-A	Factory programming product ⁽¹⁾
R5F212F2DXXXFP	8 Kbytes	1 Kbyte x 2	512 bytes	PLQP0032GB-A	D version
R5F212F4DXXXFP	16 Kbytes	1 Kbyte x 2	1 Kbyte	PLQP0032GB-A	Factory programming product ⁽¹⁾

NOTE:

1. The user ROM is programmed before shipment.

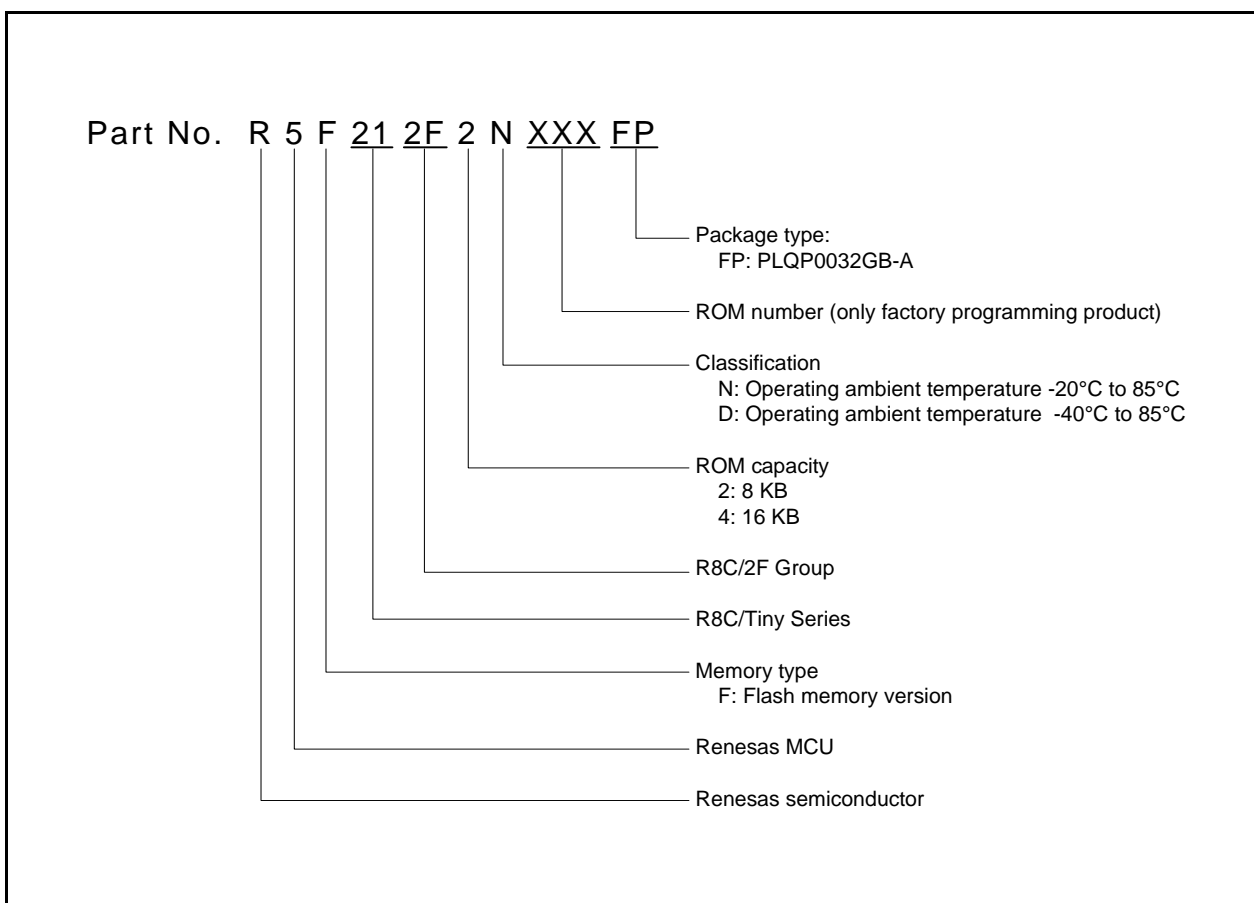

Figure 1.2 Part Number, Memory Size, and Package of R8C/2F Group

1.3 Block Diagram

Figure 1.3 shows a Block Diagram.

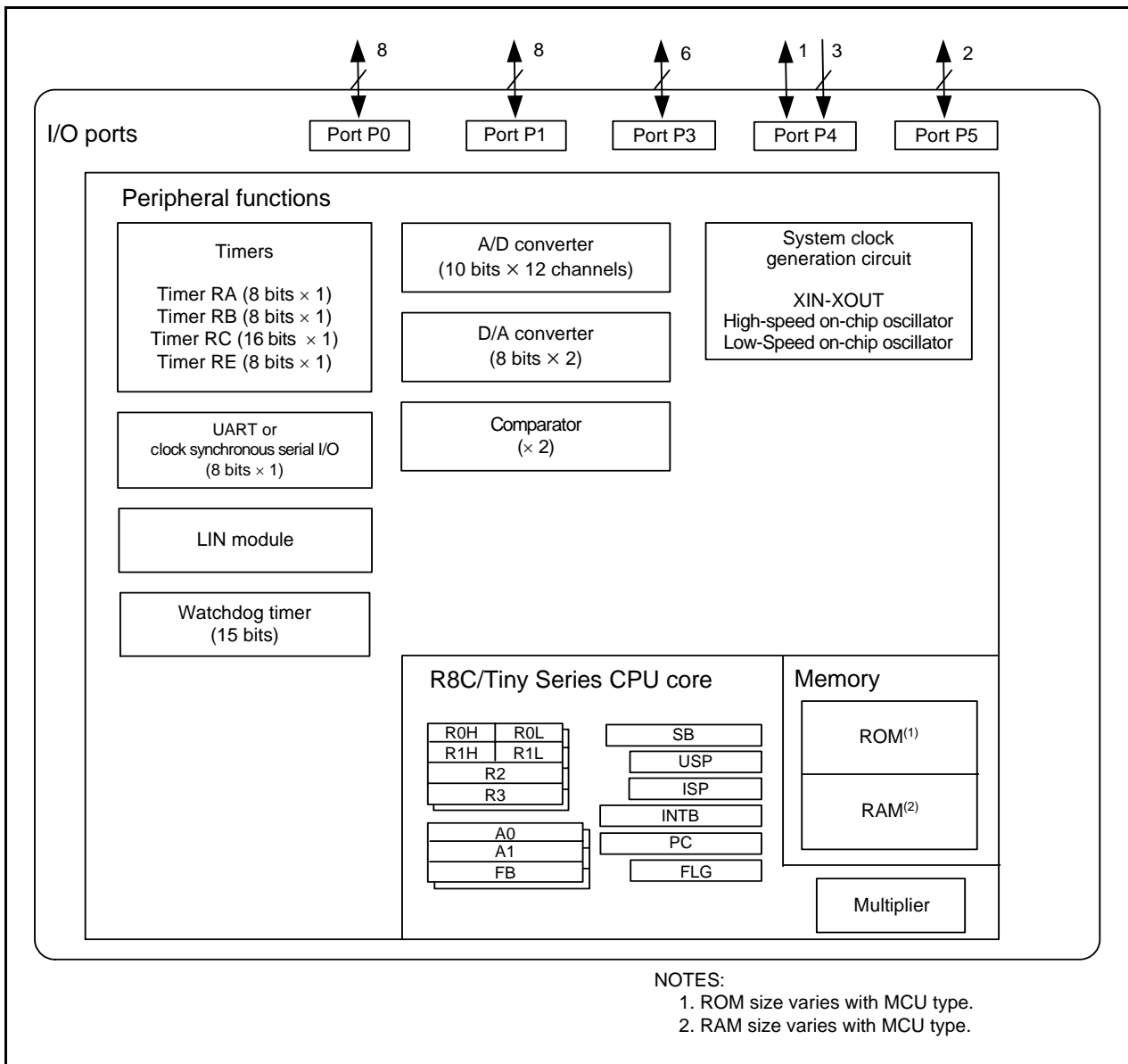

Figure 1.3 Block Diagram

1.4 Pin Assignment

Figure 1.4 shows Pin Assignments (Top View). Table 1.7 outlines the Pin Name Information by Pin Number.

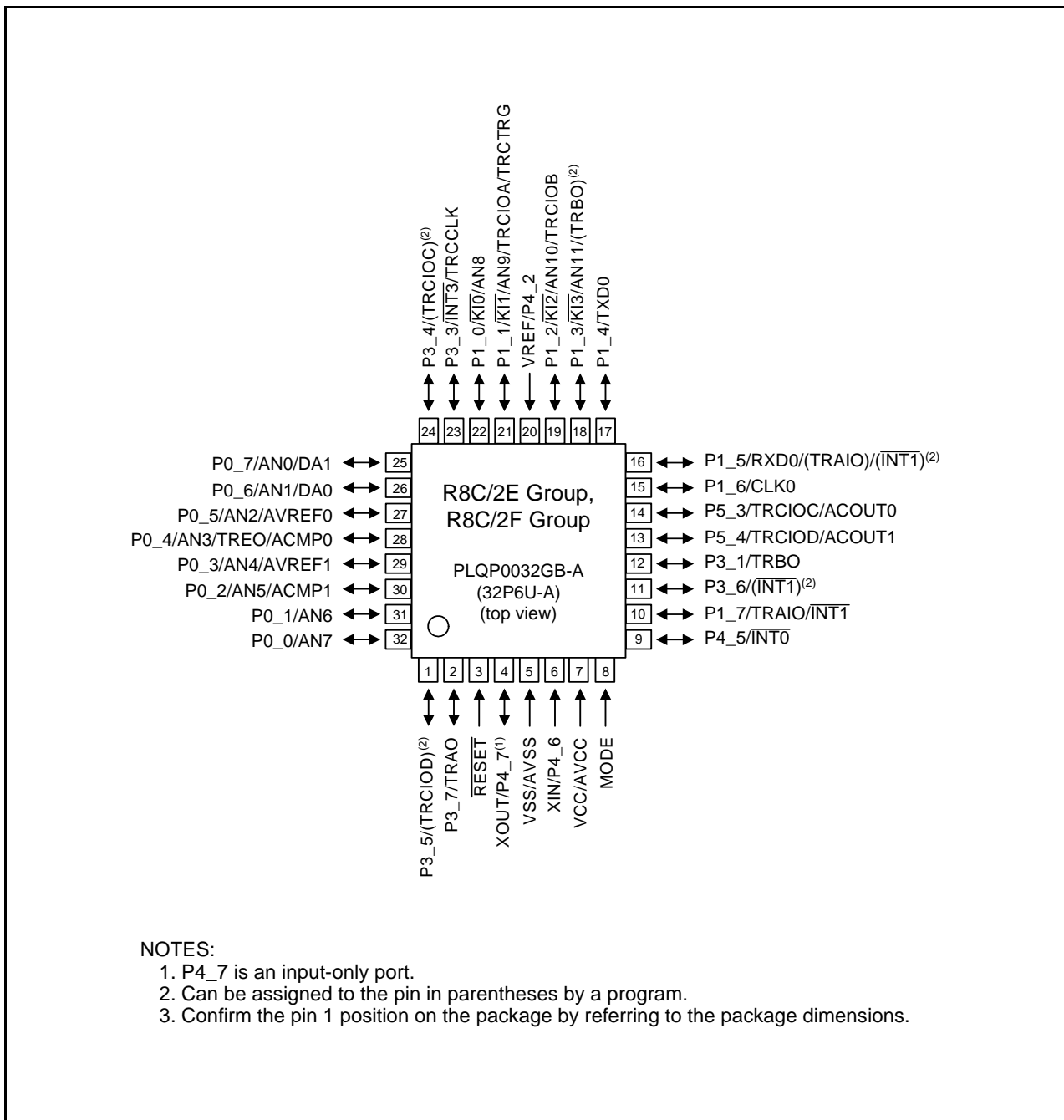

Figure 1.4 Pin Assignments (Top View)

Table 1.7 Pin Name Information by Pin Number

Pin Number	Control Pin	Port	I/O Pin Functions for of Peripheral Modules					
			Interrupt	Timer	Serial Interface	A/D Converter	D/A Converter	Comparator
1		P3_5		(TRCIOD) ⁽¹⁾				
2		P3_7		TRAO				
3	$\overline{\text{RESET}}$							
4	XOUT	P4_7						
5	VSS/AVSS							
6	XIN	P4_6						
7	VCC/AVCC							
8	MODE							
9		P4_5	$\overline{\text{INT0}}$					
10		P1_7	$\overline{\text{INT1}}$	TRAIO				
11		P3_6	$(\overline{\text{INT1}})^{(1)}$					
12		P3_1		TRBO				
13		P5_4		TRCIOD				ACOUT1
14		P5_3		TRCIOC				ACOUT0
15		P1_6			CLK0			
16		P1_5	$(\overline{\text{INT1}})^{(1)}$	$(\text{TRAIO})^{(1)}$	RXD0			
17		P1_4			TXD0			
18		P1_3	$\overline{\text{KI3}}$	$(\text{TRBO})^{(1)}$		AN11		
19		P1_2	$\overline{\text{KI2}}$	TRCIOB		AN10		
20	VREF	P4_2						
21		P1_1	$\overline{\text{KI1}}$	TRCIOA/ TRCTRG		AN9		
22		P1_0	$\overline{\text{KI0}}$			AN8		
23		P3_3	$\overline{\text{INT3}}$	TRCCLK				
24		P3_4		$(\text{TRCIOC})^{(1)}$				
25		P0_7				AN0	DA1	
26		P0_6				AN1	DA0	
27		P0_5				AN2		AVREF0
28		P0_4		TREO		AN3		ACMP0
29		P0_3				AN4		AVREF1
30		P0_2				AN5		ACMP1
31		P0_1				AN6		
32		P0_0				AN7		

NOTE:

1. Can be assigned to the pin in parentheses by a program.

1.5 Pin Functions

Table 1.8 list Pin Functions.

Table 1.8 Pin Functions

Type	Symbol	I/O Type	Description
Power supply input	VCC, VSS	I	Apply 2.7 V to 5.5 V to the VCC pin. Apply 0 V to the VSS pin.
Analog power supply input	AVCC, AVSS	I	Power supply for the A/D converter. Connect a capacitor between AVCC and AVSS.
Reset input	$\overline{\text{RESET}}$	I	Input "L" on this pin resets the MCU.
MODE	MODE	I	Connect this pin to VCC via a resistor.
XIN clock input	XIN	I	These pins are provided for XIN clock generation circuit I/O. Connect a ceramic resonator or a crystal oscillator between the XIN and XOUT pins. ⁽¹⁾ To use an external clock, input it to the XIN pin and leave the XOUT pin open.
XIN clock output	XOUT	O	
$\overline{\text{INT}}$ interrupt input	$\overline{\text{INT0}}, \overline{\text{INT1}}, \overline{\text{INT3}}$	I	$\overline{\text{INT}}$ interrupt input pins
Key input interrupt	$\overline{\text{KI0}}$ to $\overline{\text{KI3}}$	I	Key input interrupt input pins
Timer RA	TRA0	O	Timer RA output pin
	TRAIO	I/O	Timer RA I/O pin
Timer RB	TRB0	O	Timer RB output pin
Timer RC	TRCCLK	I	External clock input pin
	TRCTRIG	I	External trigger input pin
	TRCIOA, TRCIOB, TRCIOC, TRCIOD	I/O	Sharing output-compare output / input-capture input / PWM / PWM2 output pins
Timer RE	TRE0	O	Timer RE output pin
Serial interface	CLK0	I/O	Clock I/O pin
	RXD0	I	Receive data input pin
	TXD0	O	Transmit data output pin
Reference voltage input	VREF	I	Reference voltage input pin to A/D converter
A/D converter	AN0 to AN11	I	Analog input pins to A/D converter
D/A converter	DA0 to DA1	O	Output pins from D/A converter
Comparator	AVREF0 to AVREF1	I	Reference voltage input pins to comparator
	ACMP0 to ACMP1	I	Analog voltage input pins to comparator
	ACOUT0 to ACOUT1	O	Comparison result output pins of comparator
I/O port	P0_0 to P0_7, P1_0 to P1_7, P3_1, P3_3 to P3_7, P4_5, P5_3, P5_4	I/O	CMOS I/O ports. Each port has an I/O select direction register, allowing each pin in the port to be directed for input or output individually. Any port set to input can be set to use a pull-up resistor or not by a program. P1_0 to P1_7 also function as LED drive ports.
Input port	P4_2, P4_6, P4_7	I	Input-only ports

I: Input O: Output I/O: Input and output

NOTE:

1. Refer to the oscillator manufacturer for oscillation characteristics.

2. Central Processing Unit (CPU)

Figure 2.1 shows the CPU Registers. The CPU contains 13 registers. R0, R1, R2, R3, A0, A1, and FB configure a register bank. There are two sets of register bank.

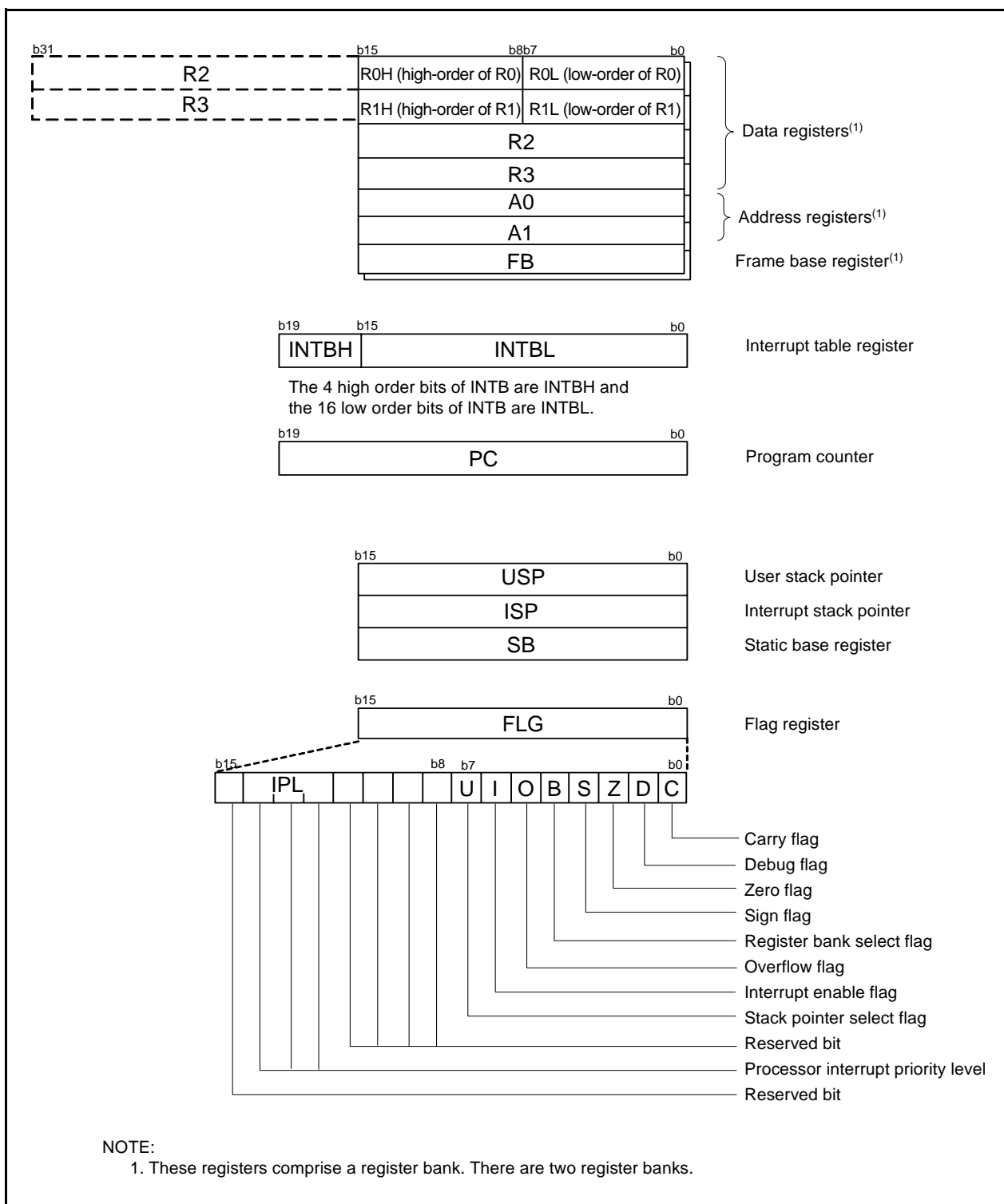

Figure 2.1 CPU Registers

2.1 Data Registers (R0, R1, R2, and R3)

R0 is a 16-bit register for transfer, arithmetic, and logic operations. The same applies to R1 to R3. R0 can be split into high-order bits (R0H) and low-order bits (R0L) to be used separately as 8-bit data registers. R1H and R1L are analogous to R0H and R0L. R2 can be combined with R0 and used as a 32-bit data register (R2R0). R3R1 is analogous to R2R0.

2.2 Address Registers (A0 and A1)

A0 is a 16-bit register for address register indirect addressing and address register relative addressing. It is also used for transfer, arithmetic, and logic operations. A1 is analogous to A0. A1 can be combined with A0 to be used as a 32-bit address register (A1A0).

2.3 Frame Base Register (FB)

FB is a 16-bit register for FB relative addressing.

2.4 Interrupt Table Register (INTB)

INTB is a 20-bit register that indicates the start address of an interrupt vector table.

2.5 Program Counter (PC)

PC is 20 bits wide and indicates the address of the next instruction to be executed.

2.6 User Stack Pointer (USP) and Interrupt Stack Pointer (ISP)

The stack pointers (SP), USP, and ISP, are each 16 bits wide. The U flag of FLG is used to switch between USP and ISP.

2.7 Static Base Register (SB)

SB is a 16-bit register for SB relative addressing.

2.8 Flag Register (FLG)

FLG is an 11-bit register indicating the CPU state.

2.8.1 Carry Flag (C)

The C flag retains carry, borrow, or shift-out bits that have been generated by the arithmetic and logic unit.

2.8.2 Debug Flag (D)

The D flag is for debugging only. Set it to 0.

2.8.3 Zero Flag (Z)

The Z flag is set to 1 when an arithmetic operation results in 0; otherwise to 0.

2.8.4 Sign Flag (S)

The S flag is set to 1 when an arithmetic operation results in a negative value; otherwise to 0.

2.8.5 Register Bank Select Flag (B)

Register bank 0 is selected when the B flag is 0. Register bank 1 is selected when this flag is set to 1.

2.8.6 Overflow Flag (O)

The O flag is set to 1 when an operation results in an overflow; otherwise to 0.

2.8.7 Interrupt Enable Flag (I)

The I flag enables maskable interrupts.

Interrupt are disabled when the I flag is set to 0, and are enabled when the I flag is set to 1. The I flag is set to 0 when an interrupt request is acknowledged.

2.8.8 Stack Pointer Select Flag (U)

ISP is selected when the U flag is set to 0; USP is selected when the U flag is set to 1.

The U flag is set to 0 when a hardware interrupt request is acknowledged or the INT instruction of software interrupt numbers 0 to 31 is executed.

2.8.9 Processor Interrupt Priority Level (IPL)

IPL is 3 bits wide and assigns processor interrupt priority levels from level 0 to level 7.

If a requested interrupt has higher priority than IPL, the interrupt is enabled.

2.8.10 Reserved Bit

If necessary, set to 0. When read, the content is undefined.

3. Memory

3.1 R8C/2E Group

Figure 3.1 is a Memory Map of R8C/2E Group. The R8C/2E group has 1 Mbyte of address space from addresses 00000h to FFFFFh.

The internal ROM is allocated lower addresses, beginning with address 0FFFFh. For example, a 16-Kbyte internal ROM area is allocated addresses 0C000h to 0FFFFh.

The fixed interrupt vector table is allocated addresses 0FFDCh to 0FFFFh. They store the starting address of each interrupt routine.

The internal RAM is allocated higher addresses beginning with address 00400h. For example, a 1-Kbyte internal RAM area is allocated addresses 00400h to 007FFh. The internal RAM is used not only for storing data but also for calling subroutines and as stacks when interrupt requests are acknowledged.

Special function registers (SFRs) are allocated addresses 00000h to 002FFh. The peripheral function control registers are allocated here. All addresses within the SFR, which have nothing allocated are reserved for future use and cannot be accessed by users.

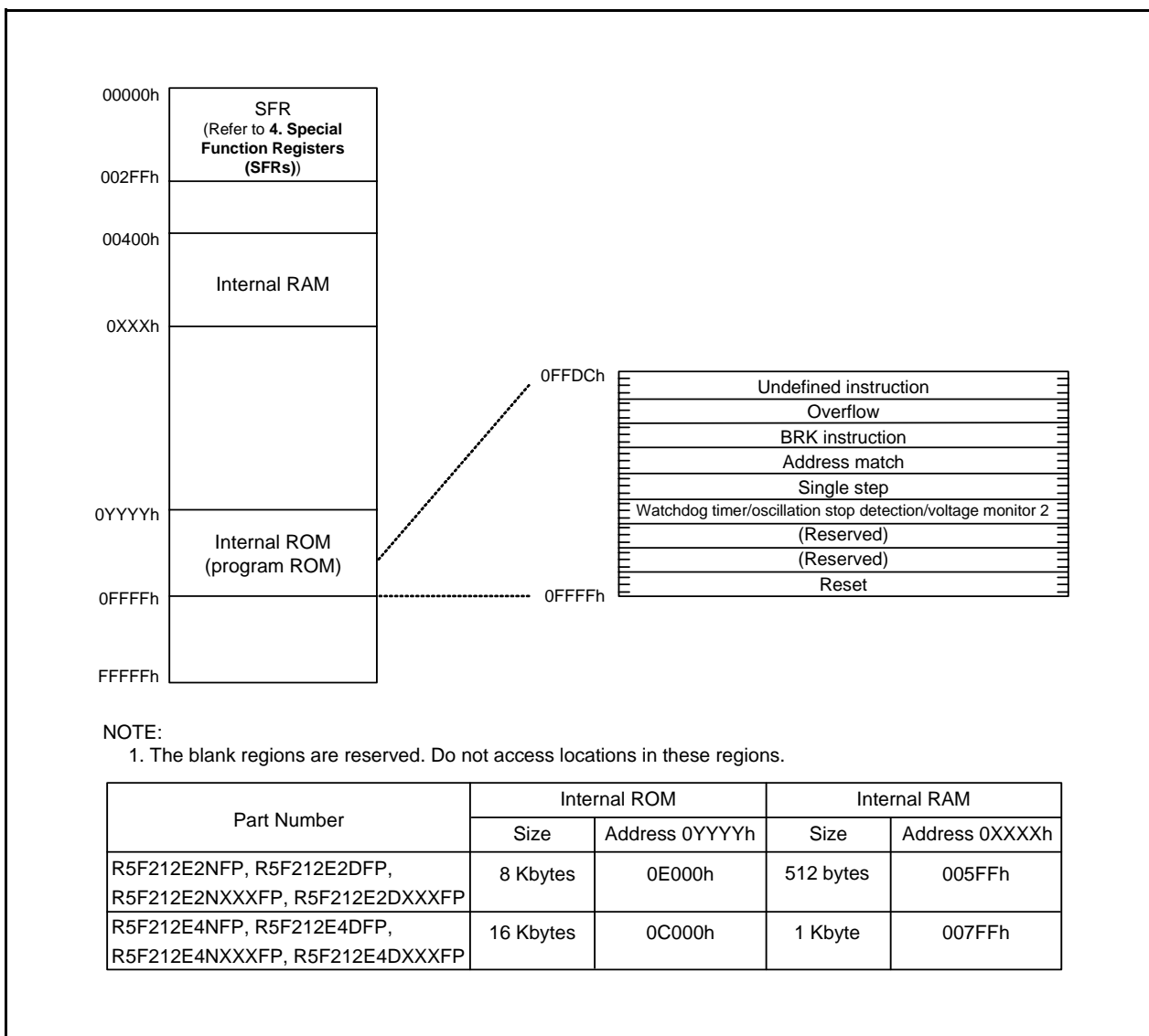

Figure 3.1 Memory Map of R8C/2E Group

3.2 R8C/2F Group

Figure 3.2 is a Memory Map of R8C/2F Group. The R8C/2F group has 1 Mbyte of address space from addresses 00000h to FFFFFh.

The internal ROM (program ROM) is allocated lower addresses, beginning with address 0FFFFh. For example, a 16-Kbyte internal ROM area is allocated addresses 0C000h to 0FFFFh.

The fixed interrupt vector table is allocated addresses 0FFDCh to 0FFFFh. They store the starting address of each interrupt routine.

The internal ROM (data flash) is allocated addresses 02400h to 02BFFh.

The internal RAM area is allocated higher addresses, beginning with address 00400h. For example, a 1-Kbyte internal RAM is allocated addresses 00400h to 007FFh. The internal RAM is used not only for storing data but also for calling subroutines and as stacks when interrupt requests are acknowledged.

Special function registers (SFRs) are allocated addresses 00000h to 002FFh. The peripheral function control registers are allocated here. All addresses within the SFR, which have nothing allocated are reserved for future use and cannot be accessed by users.

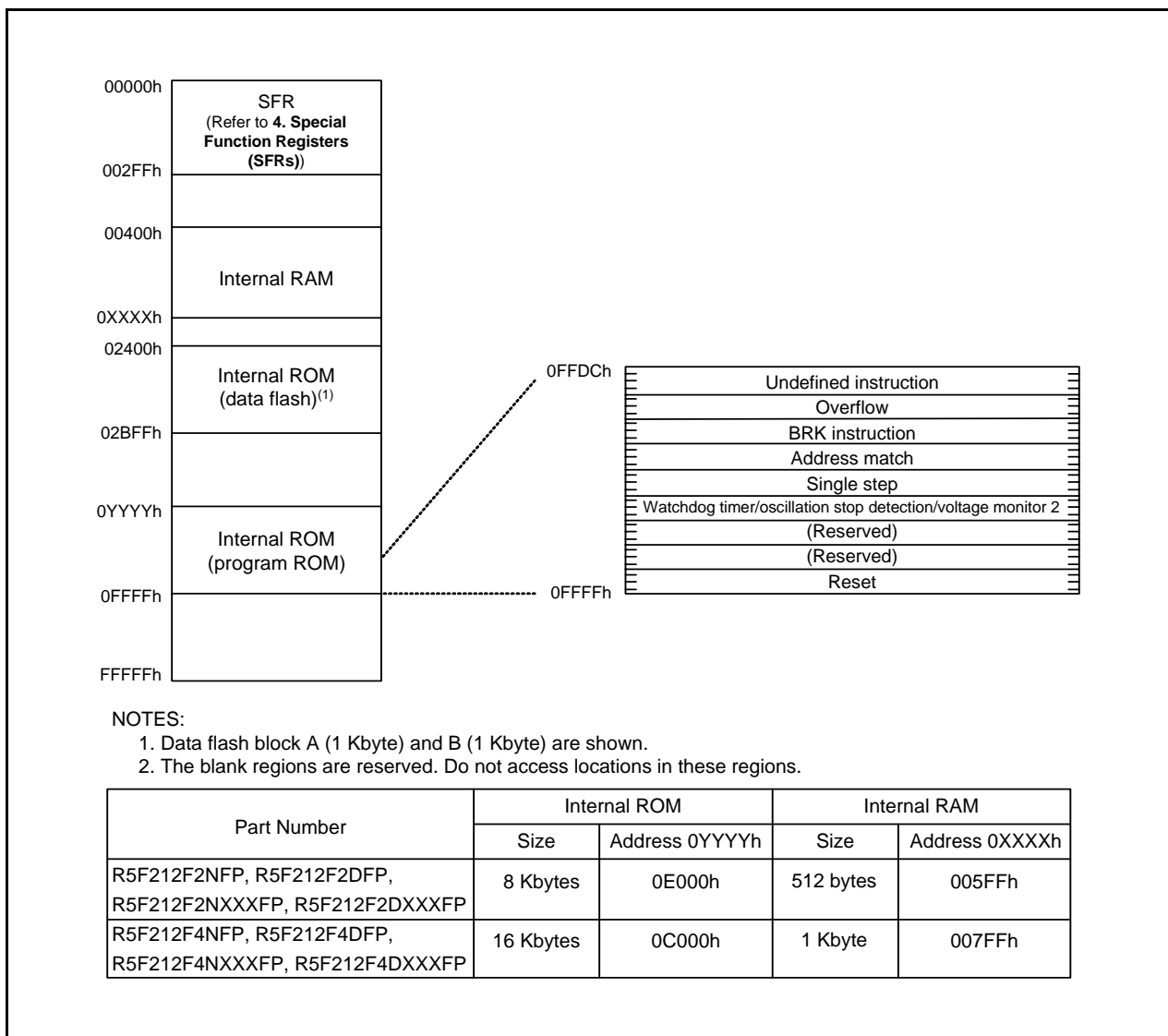

Figure 3.2 Memory Map of R8C/2F Group

4. Special Function Registers (SFRs)

An SFR (special function register) is a control register for a peripheral function. Tables 4.1 to 4.7 list the special function registers.

Table 4.1 SFR Information (1)(1)

Address	Register	Symbol	After reset
0000h			
0001h			
0002h			
0003h			
0004h	Processor Mode Register 0	PM0	00h
0005h	Processor Mode Register 1	PM1	00h
0006h	System Clock Control Register 0	CM0	01101000b
0007h	System Clock Control Register 1	CM1	00100000b
0008h			
0009h			
000Ah	Protect Register	PRCR	00h
000Bh			
000Ch	Oscillation Stop Detection Register	OCD	00000100b
000Dh	Watchdog Timer Reset Register	WDTR	XXh
000Eh	Watchdog Timer Start Register	WDTS	XXh
000Fh	Watchdog Timer Control Register	WDC	00X11111b
0010h	Address Match Interrupt Register 0	RMAD0	00h
0011h			00h
0012h			00h
0013h	Address Match Interrupt Enable Register	AIER	00h
0014h	Address Match Interrupt Register 1	RMAD1	00h
0015h			00h
0016h			00h
0017h			00h
0018h			
0019h			
001Ah			
001Bh			
001Ch	Count Source Protection Mode Register	CSPR	00h 10000000b(4)
001Dh			
001Eh			
001Fh			
0020h			
0021h			
0022h			
0023h	High-Speed On-Chip Oscillator Control Register 0	FRA0	00h
0024h	High-Speed On-Chip Oscillator Control Register 1	FRA1	When shipping
0025h	High-Speed On-Chip Oscillator Control Register 2	FRA2	00h
0026h			
0027h			
0028h			
0029h			
002Ah			
002Bh			
002Ch	High-Speed On-Chip Oscillator Control Register 7	FRA7	When Shipping
0030h			
0031h	Voltage Detection Register 1 (2)	VCA1	00001000b
0032h	Voltage Detection Register 2 (2)	VCA2	00100000b
0033h			
0034h			
0035h			
0036h	Voltage Monitor 1 Circuit Control Register(3)	VW1C	00001000b
0037h	Voltage Monitor 2 Circuit Control Register(3)	VW2C	00h
0038h			
0039h			
003Ah			
003Bh			
003Ch			
003Dh			
003Eh			
003Fh			

X: Undefined

NOTES:

- The blank regions are reserved. Do not access locations in these regions.
- Software reset, watchdog timer reset, and voltage monitor 1 reset or voltage monitor 2 reset do not affect this register.
- Software reset, watchdog timer reset, and voltage monitor 1 reset or voltage monitor 2 reset do not affect b2 and b3.
- The CSPROINI bit in the OFS register is set to 0.

Table 4.2 SFR Information (2)⁽¹⁾

Address	Register	Symbol	After reset
0040h			
0041h			
0042h			
0043h			
0044h			
0045h			
0046h			
0047h	Timer RC Interrupt Control Register	TRCIC	XXXXX000b
0048h			
0049h			
004Ah	Timer RE Interrupt Control Register	TREIC	XXXXX000b
004Bh			
004Ch			
004Dh	Key Input Interrupt Control Register	KUPIC	XXXXX000b
004Eh	A/D Conversion Interrupt Control Register	ADIC	XXXXX000b
004Fh			
0050h			
0051h	UART0 Transmit Interrupt Control Register	S0TIC	XXXXX000b
0052h	UART0 Receive Interrupt Control Register	S0RIC	XXXXX000b
0053h			
0054h			
0055h			
0056h	Timer RA Interrupt Control Register	TRAIC	XXXXX000b
0057h			
0058h	Timer RB Interrupt Control Register	TRBIC	XXXXX000b
0059h	INT1 Interrupt Control Register	INT1IC	XX00X000b
005Ah	INT3 Interrupt Control Register	INT3IC	XX00X000b
005Bh	Comparator 0 Interrupt Control Register	CM0IC	XXXXX000b
005Ch	Comparator 1 Interrupt Control Register	CM1IC	XXXXX000b
005Dh	INT0 Interrupt Control Register	INT0IC	XX00X000b
005Eh			
005Fh			
0060h			
0061h			
0062h			
0063h			
0064h			
0065h			
0066h			
0067h			
0068h			
0069h			
006Ah			
006Bh			
006Ch			
006Dh			
006Eh			
006Fh			
0070h			
0071h			
0072h			
0073h			
0074h			
0075h			
0076h			
0077h			
0078h			
0079h			
007Ah			
007Bh			
007Ch			
007Dh			
007Eh			
007Fh			

X: Undefined

NOTE:

1. The blank regions are reserved. Do not access locations in these regions.

Table 4.3 SFR Information (3)⁽¹⁾

Address	Register	Symbol	After reset
0080h			
0081h			
0082h			
0083h			
0084h			
0085h			
0086h			
0087h			
0088h			
0089h			
008Ah			
008Bh			
008Ch			
008Dh			
008Eh			
008Fh			
0090h			
0091h			
0092h			
0093h			
0094h			
0095h			
0096h			
0097h			
0098h			
0099h			
009Ah			
009Bh			
009Ch			
009Dh			
009Eh			
009Fh			
00A0h	UART0 Transmit/Receive Mode Register	U0MR	00h
00A1h	UART0 Bit Rate Register	U0BRG	XXh
00A2h	UART0 Transmit Buffer Register	U0TB	XXh
00A3h			XXh
00A4h	UART0 Transmit/Receive Control Register 0	U0C0	00001000b
00A5h	UART0 Transmit/Receive Control Register 1	U0C1	00000010b
00A6h	UART0 Receive Buffer Register	U0RB	XXh
00A7h			XXh
00A8h			
00A9h			
00AAh			
00ABh			
00ACh			
00ADh			
00AEh			
00AFh			
00B0h			
00B1h			
00B2h			
00B3h			
00B4h			
00B5h			
00B6h			
00B7h			
00B8h			
00B9h			
00BAh			
00BBh			
00BCh			
00BDh			
00BEh			
00BFh			

X: Undefined

NOTE:

1. The blank regions are reserved. Do not access locations in these regions.

Table 4.4 SFR Information (4)⁽¹⁾

Address	Register	Symbol	After reset
00C0h	A/D Register	AD	XXh
00C1h			XXh
00C2h			
00C3h			
00C4h			
00C5h			
00C6h			
00C7h			
00C8h			
00C9h			
00CAh			
00CBh			
00CCh			
00CDh			
00CEh			
00CFh			
00D0h			
00D1h			
00D2h			
00D3h			
00D4h	A/D Control Register 2	ADCON2	00h
00D5h			
00D6h	A/D Control Register 0	ADCON0	00h
00D7h	A/D Control Register 1	ADCON1	00h
00D8h	D/A Register 0	DA0	00h
00D9h			
00DAh	D/A Register 1	DA1	00h
00DBh			
00DCh	D/A Control Register	DACON	00h
00DDh			
00DEh			
00DFh			
00E0h	Port P0 Register	P0	00h
00E1h	Port P1 Register	P1	00h
00E2h	Port P0 Direction Register	PD0	00h
00E3h	Port P1 Direction Register	PD1	00h
00E4h			
00E5h	Port P3 Register	P3	00h
00E6h			
00E7h	Port P3 Direction Register	PD3	00h
00E8h	Port P4 Register	P4	00h
00E9h	Port P5 Register	P5	00h
00EAh	Port P4 Direction Register	PD4	00h
00EBh	Port P5 Direction Register	PD5	00h
00ECh			
00EDh			
00EEh			
00EFh			
00F0h			
00F1h			
00F2h			
00F3h			
00F4h			
00F5h			
00F6h	Pin Select Register 2	PINSR2	00h
00F7h	Pin Select Register 3	PINSR3	00h
00F8h	Port Mode Register	PMR	00h
00F9h	External Input Enable Register	INTEN	00h
00FAh	INT Input Filter Select Register	INTF	00h
00FBh	Key Input Enable Register	KIEN	00h
00FCh	Pull-Up Control Register 0	PUR0	00h
00FDh	Pull-Up Control Register 1	PUR1	00h
00FEh	Port P1 Drive Capacity Control Register	P1DRR	00h
00FFh			

X: Undefined

NOTE:

1. The blank regions are reserved. Do not access locations in these regions.

Table 4.5 SFR Information (5)(1)

Address	Register	Symbol	After reset
0100h	Timer RA Control Register	TRACR	00h
0101h	Timer RA I/O Control Register	TRAIOC	00h
0102h	Timer RA Mode Register	TRAMR	00h
0103h	Timer RA Prescaler Register	TRAPRE	FFh
0104h	Timer RA Register	TRA	FFh
0105h			
0106h	LIN Control Register	LINCR	00h
0107h	LIN Status Register	LINST	00h
0108h	Timer RB Control Register	TRBCR	00h
0109h	Timer RB One-Shot Control Register	TRBOCR	00h
010Ah	Timer RB I/O Control Register	TRBIOC	00h
010Bh	Timer RB Mode Register	TRBMR	00h
010Ch	Timer RB Prescaler Register	TRBPRES	FFh
010Dh	Timer RB Secondary Register	TRBSC	FFh
010Eh	Timer RB Primary Register	TRBPR	FFh
010Fh			
0110h			
0111h			
0112h			
0113h			
0114h			
0115h			
0116h			
0117h			
0118h	Timer RE Counter Data Register	TRESEC	00h
0119h	Timer RE Compare Data Register	TREMIN	00h
011Ah			
011Bh			
011Ch	Timer RE Control Register 1	TRECR1	00h
011Dh	Timer RE Control Register 2	TRECR2	00h
011Eh	Timer RE Clock Source Select Register	TRECSR	00001000b
011Fh			
0120h	Timer RC Mode Register	TRCMR	01001000b
0121h	Timer RC Control Register 1	TRCCR1	00h
0122h	Timer RC Interrupt Enable Register	TRCIER	01110000b
0123h	Timer RC Status Register	TRCSR	01110000b
0124h	Timer RC I/O Control Register 0	TRCIOR0	10001000b
0125h	Timer RC I/O Control Register 1	TRCIOR1	10001000b
0126h	Timer RC Counter	TRC	00h
0127h			00h
0128h	Timer RC General Register A	TRCGRA	FFh
0129h			FFh
012Ah	Timer RC General Register B	TRCGRB	FFh
012Bh			FFh
012Ch	Timer RC General Register C	TRCGRC	FFh
012Dh			FFh
012Eh	Timer RC General Register D	TRCGRD	FFh
012Fh			FFh
0130h	Timer RC Control Register 2	TRCCR2	00011111b
0131h	Timer RC Digital Filter Function Select Register	TRCDF	00h
0132h	Timer RC Output Master Enable Register	TRCOER	01111111b
0133h			
0134h			
0135h			
0136h			
0137h			
0138h			
0139h			
013Ah			
013Bh			
013Ch			
013Dh			
013Eh			
013Fh			

X: Undefined

NOTE:

1. The blank regions are reserved. Do not access locations in these regions.

Table 4.6 SFR Information (6)⁽¹⁾

Address	Register	Symbol	After reset
0140h			
0141h			
0142h			
0143h			
0144h			
0145h			
0146h			
0147h			
0148h			
0149h			
014Ah			
014Bh			
014Ch			
014Dh			
014Eh			
014Fh			
0150h			
0151h			
0152h			
0153h			
0154h			
0155h			
0156h			
0157h			
0158h			
0159h			
015Ah			
015Bh			
015Ch			
015Dh			
015Eh			
015Fh			
0160h			
0161h			
0162h			
0163h			
0164h			
0165h			
0166h			
0167h			
0168h			
0169h			
016Ah			
016Bh			
016Ch			
016Dh			
016Eh			
016Fh			
0170h			
0171h			
0172h			
0173h			
0174h	Comparator 0 Control Register	ACCR0	00001000b
0175h	Comparator 1 Control Register	ACCR1	00001000b
0176h			
0177h	Comparator Mode Register	ACMR	00h
0178h			
0179h			
017Ah			
017Bh			
017Ch			
017Dh			
017Eh			
017Fh			

X: Undefined

NOTE:

1. The blank regions are reserved. Do not access locations in these regions.

Table 4.7 SFR Information (7)⁽¹⁾

Address	Register	Symbol	After reset
0180h			
0181h			
0182h			
0183h			
0184h			
0185h			
0186h			
0187h			
0188h			
0189h			
018Ah			
018Bh			
018Ch			
018Dh			
018Eh			
018Fh			
0190h			
0191h			
0192h			
0193h			
0194h			
0195h			
0196h			
0197h			
0198h			
0199h			
019Ah			
019Bh			
019Ch			
019Dh			
019Eh			
019Fh			
01A0h			
01A1h			
01A2h			
01A3h			
01A4h			
01A5h			
01A6h			
01A7h			
01A8h			
01A9h			
01AAh			
01ABh			
01ACh			
01ADh			
01AEh			
01AFh			
01B0h			
01B1h			
01B2h			
01B3h	Flash Memory Control Register 4	FMR4	01000000b
01B4h			
01B5h	Flash Memory Control Register1	FMR1	1000000Xb
01B6h			
01B7h	Flash Memory Control Register 0	FMR0	00000001b
01B8h			
01B9h			
01BAh			
01BBh			
01BCh			
01BDh			
01BEh			
01BFh			
FFFFh	Option Function Select Register	OFS	(Note 2)

X: Undefined

NOTES:

1. The blank regions are reserved. Do not access locations in these regions.
2. The OFS register cannot be changed by a program. Use a flash programmer to write to it.

5. Electrical Characteristics

Table 5.1 Absolute Maximum Ratings

Symbol	Parameter	Condition	Rated Value	Unit
V _{CC} /AV _{CC}	Supply voltage		-0.3 to 6.5	V
V _I	Input voltage		-0.3 to V _{CC} + 0.3	V
V _O	Output voltage		-0.3 to V _{CC} + 0.3	V
P _d	Power dissipation	T _{opr} = 25°C	500	mW
T _{opr}	Operating ambient temperature		-20 to 85 (N version) / -40 to 85 (D version)	°C
T _{stg}	Storage temperature		-65 to 150	°C

Table 5.2 Recommended Operating Conditions

Symbol	Parameter		Conditions	Standard			Unit
				Min.	Typ.	Max.	
V _{CC} /AV _{CC}	Supply voltage			2.7	–	5.5	V
V _{SS} /AV _{SS}	Supply voltage			–	0	–	V
V _{IH}	Input “H” voltage			0.8 V _{CC}	–	V _{CC}	V
V _{IL}	Input “L” voltage			0	–	0.2 V _{CC}	V
I _{OH(sum)}	Peak sum output “H” current	Sum of all pins I _{OH(peak)}		–	–	-160	mA
I _{OH(sum)}	Average sum output “H” current	Sum of all pins I _{OH(avg)}		–	–	-80	mA
I _{OH(peak)}	Peak output “H” current	Except P1_0 to P1_7		–	–	-10	mA
		P1_0 to P1_7		–	–	-20	mA
I _{OH(avg)}	Average output “H” current	Except P1_0 to P1_7		–	–	-5	mA
		P1_0 to P1_7		–	–	-10	mA
I _{OL(sum)}	Peak sum output “L” currents	Sum of all pins I _{OL(peak)}		–	–	160	mA
I _{OL(sum)}	Average sum output “L” currents	Sum of all pins I _{OL(avg)}		–	–	80	mA
I _{OL(peak)}	Peak output “L” currents	Except P1_0 to P1_7		–	–	10	mA
		P1_0 to P1_7		–	–	20	mA
I _{OL(avg)}	Average output “L” current	Except P1_0 to P1_7		–	–	5	mA
		P1_0 to P1_7		–	–	10	mA
f _(XIN)	XIN clock input oscillation frequency		3.0 V ≤ V _{CC} ≤ 5.5 V	0	–	20	MHz
			2.7 V ≤ V _{CC} < 3.0 V	0	–	10	MHz
–	System clock	OCD2 = 0 XIN clock selected	3.0 V ≤ V _{CC} ≤ 5.5 V	0	–	20	MHz
			2.7 V ≤ V _{CC} < 3.0 V	0	–	10	MHz
		OCD2 = 1 On-chip oscillator clock selected	FRA01 = 0 Low-speed on-chip oscillator clock selected	–	125	–	kHz
			FRA01 = 1 High-speed on-chip oscillator clock selected 3.0 V ≤ V _{CC} ≤ 5.5 V	–	–	20	MHz
			FRA01 = 1 High-speed on-chip oscillator clock selected 2.7 V ≤ V _{CC} ≤ 5.5 V	–	–	10	MHz

NOTES:

- V_{CC} = 2.7 to 5.5 V at T_{opr} = -20 to 85°C (N version) / -40 to 85°C (D version), unless otherwise specified.
- The average output current indicates the average value of current measured during 100 ms.

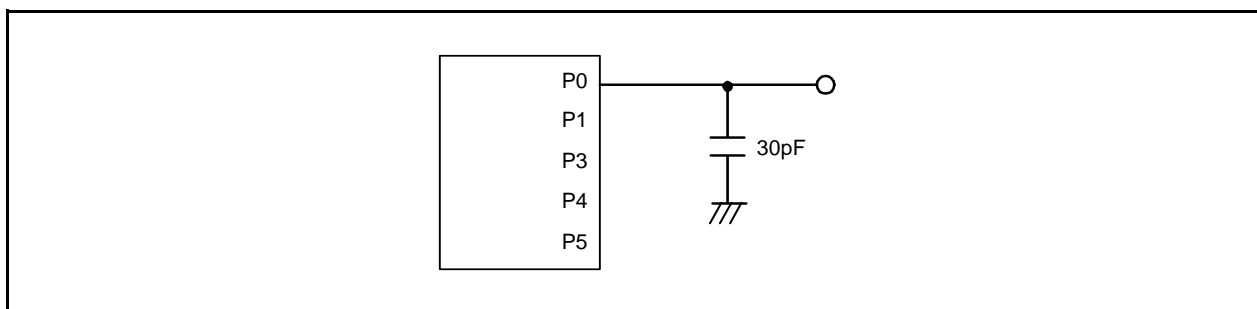

Figure 5.1 Ports P0, P1, and P3 to P5 Timing Measurement Circuit

Table 5.3 A/D Converter Characteristics

Symbol	Parameter		Conditions	Standard			Unit
				Min.	Typ.	Max.	
–	Resolution		$V_{ref} = AV_{CC}$	–	–	10	Bits
–	Absolute accuracy	10-bit mode	$\phi_{AD} = 10 \text{ MHz}$, $V_{ref} = AV_{CC} = 5.0 \text{ V}$	–	–	± 3	LSB
		8-bit mode	$\phi_{AD} = 10 \text{ MHz}$, $V_{ref} = AV_{CC} = 5.0 \text{ V}$	–	–	± 2	LSB
		10-bit mode	$\phi_{AD} = 10 \text{ MHz}$, $V_{ref} = AV_{CC} = 3.3 \text{ V}$	–	–	± 5	LSB
		8-bit mode	$\phi_{AD} = 10 \text{ MHz}$, $V_{ref} = AV_{CC} = 3.3 \text{ V}$	–	–	± 2	LSB
R_{ladder}	Resistor ladder		$V_{ref} = AV_{CC}$	10	–	40	$k\Omega$
t_{conv}	Conversion time	10-bit mode	$\phi_{AD} = 10 \text{ MHz}$, $V_{ref} = AV_{CC} = 5.0 \text{ V}$	3.3	–	–	μs
		8-bit mode	$\phi_{AD} = 10 \text{ MHz}$, $V_{ref} = AV_{CC} = 5.0 \text{ V}$	2.8	–	–	μs
V_{ref}	Reference voltage			2.7	–	AV_{CC}	V
V_{IA}	Analog input voltage ⁽²⁾			0	–	AV_{CC}	V
–	A/D operating clock frequency	Without sample and hold	$V_{ref} = AV_{CC} = 2.7 \text{ to } 5.5 \text{ V}$	0.25	–	10	MHz
		With sample and hold	$V_{ref} = AV_{CC} = 2.7 \text{ to } 5.5 \text{ V}$	1	–	10	MHz

NOTES:

1. $AV_{CC} = 2.7 \text{ to } 5.5 \text{ V}$ at $T_{opr} = -20 \text{ to } 85^\circ\text{C}$ (N version) / $-40 \text{ to } 85^\circ\text{C}$ (D version), unless otherwise specified.
2. When the analog input voltage is over the reference voltage, the A/D conversion result will be 3FFh in 10-bit mode and FFh in 8-bit mode.

Table 5.4 D/A Converter Characteristics

Symbol	Parameter		Conditions	Standard			Unit
				Min.	Typ.	Max.	
–	Resolution			–	–	8	Bit
–	Absolute accuracy			–	–	1.0	%
t_{su}	Setup time			–	–	3	μs
R_o	Output resistor			4	10	20	$k\Omega$
I_{Vref}	Reference power input current		(NOTE 2)	–	–	1.5	mA

NOTES:

1. $AV_{CC} = 2.7 \text{ to } 5.5 \text{ V}$ at $T_{opr} = -20 \text{ to } 85^\circ\text{C}$ (N version) / $-40 \text{ to } 85^\circ\text{C}$ (D version), unless otherwise specified.
2. This applies when one D/A converter is used and the value of the DAi register ($i = 0 \text{ or } 1$) for the unused D/A converter is 00h. The resistor ladder of the A/D converter is not included. Also, even if the VCUT bit in the ADCON1 register is set to 0 (V_{REF} not connected), I_{Vref} flows into the D/A converters.

Table 5.5 Comparator Characteristics(1)

Symbol	Parameter	Conditions	Standard			Unit
			Min.	Typ.	Max.	
V _{cref}	Comparator reference voltage		0	–	V _{CC} –1.2	V
V _{cin}	Comparator input voltage		–0.3	–	V _{CC} +0.3	V
V _{ofs}	Input offset voltage		–	–	±100	mV
T _{crsp}	Response time		–	–	200	ns

NOTE:

- V_{CC} = 2.7 to 5.5 V at T_{opr} = –20 to 85°C (N version) / –40 to 85°C (D version), unless otherwise specified.

Table 5.6 Flash Memory (Program ROM) Electrical Characteristics

Symbol	Parameter	Conditions	Standard			Unit
			Min.	Typ.	Max.	
–	Program/erase endurance ⁽²⁾	R8C/2E Group	100 ⁽³⁾	–	–	times
		R8C/2F Group	1,000 ⁽³⁾	–	–	times
–	Byte program time		–	50	400	μs
–	Block erase time		–	0.4	9	s
t _{d(SR-SUS)}	Time delay from suspend request until suspend		–	–	97+CPU clock × 6 cycles	μs
–	Interval from erase start/restart until following suspend request		650	–	–	μs
–	Interval from program start/restart until following suspend request		0	–	–	ns
–	Time from suspend until program/erase restart		–	–	3+CPU clock × 4 cycles	μs
–	Program, erase voltage		2.7	–	5.5	V
–	Read voltage		2.7	–	5.5	V
–	Program, erase temperature		0	–	60	°C
–	Data hold time ⁽⁷⁾	Ambient temperature = 55°C	20	–	–	year

NOTES:

- V_{CC} = 2.7 to 5.5 V at T_{opr} = 0 to 60°C, unless otherwise specified.
- Definition of programming/erasure endurance
The programming and erasure endurance is defined on a per-block basis.
If the programming and erasure endurance is n (n = 100 or 10,000), each block can be erased n times. For example, if 1,024 1-byte writes are performed to block A, a 1 Kbyte block, and then the block is erased, the programming/erasure endurance still stands at one.
However, the same address must not be programmed more than once per erase operation (overwriting prohibited).
- Endurance to guarantee all electrical characteristics after program and erase. (1 to Min. value can be guaranteed).
- In a system that executes multiple programming operations, the actual erasure count can be reduced by writing to sequential addresses in turn so that as much of the block as possible is used up before performing an erase operation. For example, when programming groups of 16 bytes, the effective number of rewrites can be minimized by programming up to 128 groups before erasing them all in one operation. It is also advisable to retain data on the erase count of each block and limit the number of erase operations to a certain number.
- If an error occurs during block erase, attempt to execute the clear status register command, then execute the block erase command at least three times until the erase error does not occur.
- Customers desiring program/erase failure rate information should contact their Renesas technical support representative.
- The data hold time includes time that the power supply is off or the clock is not supplied.

Table 5.7 Flash Memory (Data flash Block A, Block B) Electrical Characteristics⁽⁴⁾

Symbol	Parameter	Conditions	Standard			Unit
			Min.	Typ.	Max.	
–	Program/erase endurance ⁽²⁾		10,000 ⁽³⁾	–	–	times
–	Byte program time (program/erase endurance ≤ 1,000 times)		–	50	400	μs
–	Byte program time (program/erase endurance > 1,000 times)		–	65	–	μs
–	Block erase time (program/erase endurance ≤ 1,000 times)		–	0.2	9	s
–	Block erase time (program/erase endurance > 1,000 times)		–	0.3	–	s
t _d (SR-SUS)	Time delay from suspend request until suspend		–	–	97+CPU clock × 6 cycles	μs
–	Interval from erase start/restart until following suspend request		650	–	–	μs
–	Interval from program start/restart until following suspend request		0	–	–	ns
–	Time from suspend until program/erase restart		–	–	3+CPU clock × 4 cycles	μs
–	Program, erase voltage		2.7	–	5.5	V
–	Read voltage		2.7	–	5.5	V
–	Program, erase temperature		–20 ⁽⁸⁾	–	85	°C
–	Data hold time ⁽⁹⁾	Ambient temperature = 55 °C	20	–	–	year

NOTES:

- V_{CC} = 2.7 to 5.5 V at T_{opr} = –20 to 85°C (N version) / –40 to 85°C (D version), unless otherwise specified.
- Definition of programming/erasure endurance
The programming and erasure endurance is defined on a per-block basis.
If the programming and erasure endurance is n (n = 100 or 10,000), each block can be erased n times. For example, if 1,024 1-byte writes are performed to block A, a 1 Kbyte block, and then the block is erased, the programming/erasure endurance still stands at one.
However, the same address must not be programmed more than once per erase operation (overwriting prohibited).
- Endurance to guarantee all electrical characteristics after program and erase. (1 to Min. value can be guaranteed).
- Standard of block A and block B when program and erase endurance exceeds 1,000 times. Byte program time to 1,000 times is the same as that in program ROM.
- In a system that executes multiple programming operations, the actual erasure count can be reduced by writing to sequential addresses in turn so that as much of the block as possible is used up before performing an erase operation. For example, when programming groups of 16 bytes, the effective number of rewrites can be minimized by programming up to 128 groups before erasing them all in one operation. It is also advisable to retain data on the erase count of each block and limit the number of erase operations to a certain number.
- If an error occurs during block erase, attempt to execute the clear status register command, then execute the block erase command at least three times until the erase error does not occur.
- Customers desiring program/erase failure rate information should contact their Renesas technical support representative.
- 40°C for D version.
- The data hold time includes time that the power supply is off or the clock is not supplied.

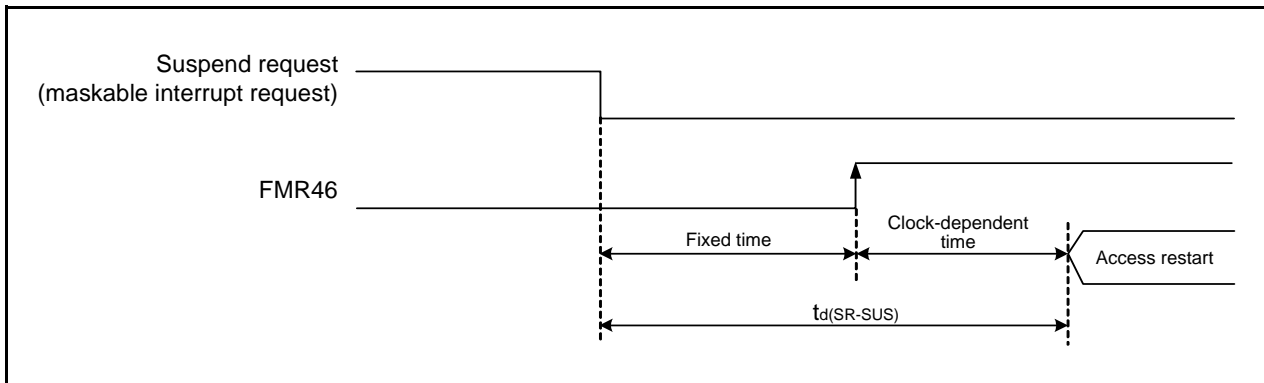

Figure 5.2 Time delay until Suspend

Table 5.8 Voltage Detection 1 Circuit Electrical Characteristics

Symbol	Parameter	Condition	Standard			Unit
			Min.	Typ.	Max.	
V _{det1}	Voltage detection level ⁽⁴⁾		2.7	2.85	3.00	V
–	Voltage monitor 1 interrupt request generation time ⁽²⁾		–	40	–	μs
–	Voltage detection circuit self power consumption	VCA26 = 1, V _{CC} = 5.0 V	–	0.6	–	μA
t _{d(E-A)}	Waiting time until voltage detection circuit operation starts ⁽³⁾		–	–	100	μs
V _{ccmin}	MCU operating voltage minimum value		2.7	–	–	V

NOTES:

1. The measurement condition is V_{CC} = 2.7 V to 5.5 V and T_{opr} = –20 to 85°C (N version) / –40 to 85°C (D version).
2. Time until the voltage monitor 1 interrupt request is generated after the voltage passes V_{det1}.
3. Necessary time until the voltage detection circuit operates when setting to 1 again after setting the VCA26 bit in the VCA2 register to 0.
4. This parameter shows the voltage detection level when the power supply drops.
The voltage detection level when the power supply rises is higher than the voltage detection level when the power supply drops by approximately 0.1 V.

Table 5.9 Voltage Detection 2 Circuit Electrical Characteristics

Symbol	Parameter	Condition	Standard			Unit
			Min.	Typ.	Max.	
V _{det2}	Voltage detection level		3.3	3.6	3.9	V
–	Voltage monitor 2 interrupt request generation time ⁽²⁾		–	40	–	μs
–	Voltage detection circuit self power consumption	VCA27 = 1, V _{CC} = 5.0 V	–	0.6	–	μA
t _{d(E-A)}	Waiting time until voltage detection circuit operation starts ⁽³⁾		–	–	100	μs

NOTES:

1. The measurement condition is V_{CC} = 2.7 V to 5.5 V and T_{opr} = –20 to 85°C (N version) / –40 to 85°C (D version).
2. Time until the voltage monitor 2 interrupt request is generated after the voltage passes V_{det2}.
3. Necessary time until the voltage detection circuit operates after setting to 1 again after setting the VCA27 bit in the VCA2 register to 0.

Table 5.10 Power-on Reset Circuit, Voltage Monitor 0 Reset Electrical Characteristics

Symbol	Parameter	Condition	Standard			Unit
			Min.	Typ.	Max.	
V _{por1}	Power-on reset valid voltage ⁽³⁾		–	–	0.1	V
V _{por2}	Power-on reset valid voltage		0	–	2.6	V
t _{trth}	External power V _{cc} rise gradient ⁽²⁾		20	–	–	mV/msec

NOTES:

1. The measurement condition is T_{opr} = –20 to 85°C (N version) / –40 to 85°C (D version), unless otherwise specified.
2. This condition (external power V_{cc} rise gradient) does not apply if V_{cc} ≥ 1.0 V.
3. t_{w(por1)} indicates the duration the external power V_{cc} must be held below the effective voltage (V_{por1}) to enable a power on reset. When turning on the power for the first time, maintain t_{w(por1)} for 30 s or more if –20°C ≤ T_{opr} ≤ 85°C, maintain t_{w(por1)} for 3,000 s or more if –40°C ≤ T_{opr} < –20°C.

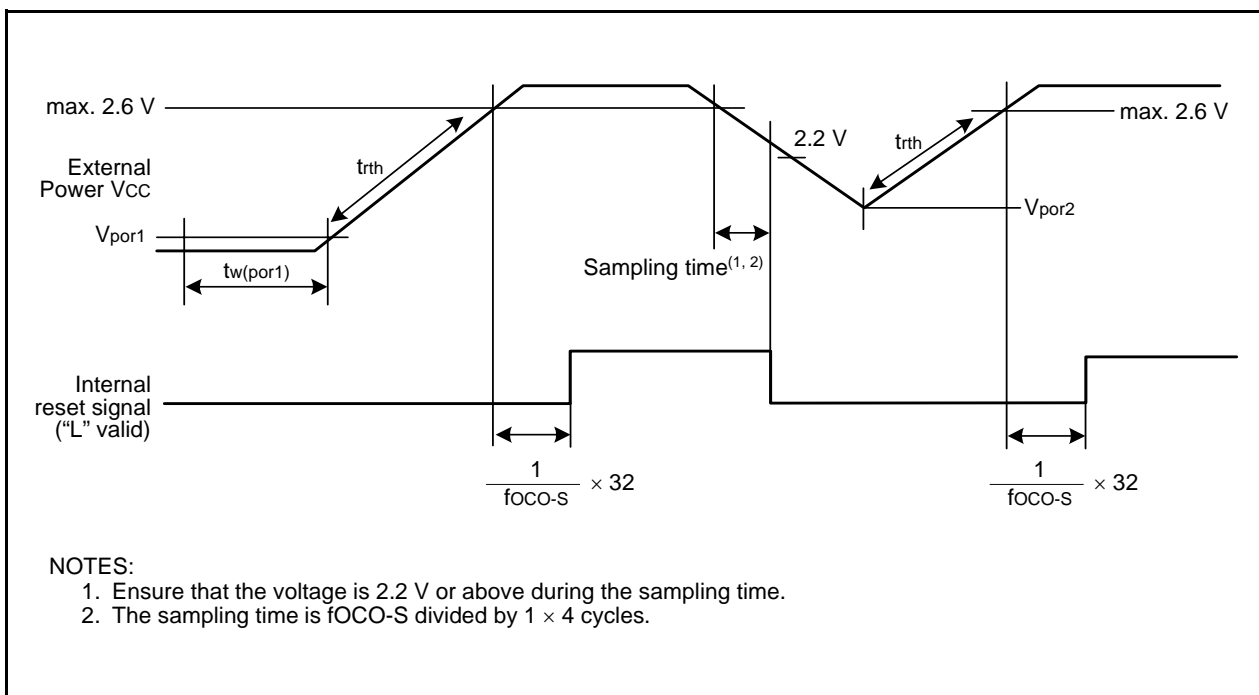

Figure 5.3 Reset Circuit Electrical Characteristics

Table 5.11 High-speed On-Chip Oscillator Circuit Electrical Characteristics

Symbol	Parameter	Condition	Standard			Unit
			Min.	Typ.	Max.	
fOCO40M	High-speed on-chip oscillator frequency temperature • supply voltage dependence	$V_{CC} = 4.75 \text{ V to } 5.25 \text{ V}$ $0^{\circ}\text{C} \leq T_{opr} \leq 60^{\circ}\text{C}^{(2)}$	39.2	40	40.8	MHz
		$V_{CC} = 3.0 \text{ V to } 5.5 \text{ V}$ $-20^{\circ}\text{C} \leq T_{opr} \leq 85^{\circ}\text{C}^{(2)}$	38.8	40	41.2	MHz
		$V_{CC} = 3.0 \text{ V to } 5.5 \text{ V}$ $-40^{\circ}\text{C} \leq T_{opr} \leq 85^{\circ}\text{C}^{(2)}$	38.4	40	41.6	MHz
		$V_{CC} = 2.7 \text{ V to } 5.5 \text{ V}$ $-20^{\circ}\text{C} \leq T_{opr} \leq 85^{\circ}\text{C}^{(2)}$	38	40	42	MHz
		$V_{CC} = 2.7 \text{ V to } 5.5 \text{ V}$ $-40^{\circ}\text{C} \leq T_{opr} \leq 85^{\circ}\text{C}^{(2)}$	37.6	40	42.4	MHz
		$V_{CC} = 5.0 \text{ V} \pm 10\%$ $-20^{\circ}\text{C} \leq T_{opr} \leq 85^{\circ}\text{C}^{(2)}$	38.8	40	40.8	MHz
		$V_{CC} = 5.0 \text{ V} \pm 10\%$ $-40^{\circ}\text{C} \leq T_{opr} \leq 85^{\circ}\text{C}^{(2)}$	38.4	40	40.8	MHz
	High-speed on-chip oscillator frequency when correction value in FRA7 register is written to FRA1 register	$V_{CC} = 5.0 \text{ V}, T_{opr} = 25^{\circ}\text{C}$	–	36.864	–	MHz
$V_{CC} = 2.7 \text{ V to } 5.5 \text{ V}$ $-20^{\circ}\text{C} \leq T_{opr} \leq 85^{\circ}\text{C}$		–3%	–	3%	%	
–	Value in FRA1 register after reset		08h	–	F7h	–
–	Oscillation frequency adjustment unit of high-speed on-chip oscillator	Adjust FRA1 register (value after reset) to –1	–	+0.3	–	MHz
–	Oscillation stability time		–	10	100	μs
–	Self power consumption at oscillation	$V_{CC} = 5.0 \text{ V}, T_{opr} = 25^{\circ}\text{C}$	–	400	–	μA

NOTES:

- $V_{CC} = 2.7 \text{ to } 5.5 \text{ V}, T_{opr} = -20 \text{ to } 85^{\circ}\text{C}$ (N version) / $-40 \text{ to } 85^{\circ}\text{C}$ (D version), unless otherwise specified.
- These standard values show when the FRA1 register value after reset is assumed.

Table 5.12 Low-speed On-Chip Oscillator Circuit Electrical Characteristics

Symbol	Parameter	Condition	Standard			Unit
			Min.	Typ.	Max.	
fOCO-S	Low-speed on-chip oscillator frequency		30	125	250	kHz
–	Oscillation stability time		–	10	100	μs
–	Self power consumption at oscillation	$V_{CC} = 5.0 \text{ V}, T_{opr} = 25^{\circ}\text{C}$	–	15	–	μA

NOTE:

- $V_{CC} = 2.7 \text{ to } 5.5 \text{ V}, T_{opr} = -20 \text{ to } 85^{\circ}\text{C}$ (N version) / $-40 \text{ to } 85^{\circ}\text{C}$ (D version), unless otherwise specified.

Table 5.13 Power Supply Circuit Timing Characteristics

Symbol	Parameter	Condition	Standard			Unit
			Min.	Typ.	Max.	
t _d (P-R)	Time for internal power supply stabilization during power-on ⁽²⁾		1	–	2000	μs
t _d (R-S)	STOP exit time ⁽³⁾		–	–	150	μs

NOTES:

- The measurement condition is $V_{CC} = 2.7 \text{ to } 5.5 \text{ V}$ and $T_{opr} = 25^{\circ}\text{C}$.
- Waiting time until the internal power supply generation circuit stabilizes during power-on.
- Time until system clock supply starts after the interrupt is acknowledged to exit stop mode.

Table 5.14 Electrical Characteristics (1) [V_{CC} = 5 V]

Symbol	Parameter		Condition		Standard			Unit	
					Min.	Typ.	Max.		
V _{OH}	Output "H" voltage	Except P1_0 to P1_7, XOUT	I _{OH} = -5 mA		V _{CC} - 2.0	-	V _{CC}	V	
			I _{OH} = -200 μA		V _{CC} - 0.5	-	V _{CC}	V	
	P1_0 to P1_7		Drive capacity HIGH	I _{OH} = -10 mA	V _{CC} - 2.0	-	V _{CC}	V	
			Drive capacity LOW	I _{OH} = -5 mA	V _{CC} - 2.0	-	V _{CC}	V	
	XOUT		Drive capacity HIGH	I _{OH} = -1 mA	V _{CC} - 2.0	-	V _{CC}	V	
			Drive capacity LOW	I _{OH} = -500 μA	V _{CC} - 2.0	-	V _{CC}	V	
V _{OL}	Output "L" voltage	Except P1_0 to P1_7, XOUT	I _{OL} = 5 mA		-	-	2.0	V	
			I _{OL} = 200 μA		-	-	0.45	V	
	P1_0 to P1_7		Drive capacity HIGH	I _{OL} = 10 mA	-	-	2.0	V	
			Drive capacity LOW	I _{OL} = 5 mA	-	-	2.0	V	
	XOUT		Drive capacity HIGH	I _{OL} = 1 mA	-	-	2.0	V	
			Drive capacity LOW	I _{OL} = 500 μA	-	-	2.0	V	
V _{T+} -V _{T-}	Hysteresis	$\overline{\text{INT0}}, \overline{\text{INT1}}, \overline{\text{INT3}},$ $\overline{\text{KI0}}, \overline{\text{KI1}}, \overline{\text{KI2}}, \overline{\text{KI3}},$ $\overline{\text{TRAIO}}, \overline{\text{RXD0}}, \overline{\text{CLK0}}$			0.1	0.5	-	V	
		$\overline{\text{RESET}}$			0.1	1.0	-	V	
I _{IH}	Input "H" current			V _I = 5 V, V _{CC} = 5 V		-	-	5.0	μA
I _{IL}	Input "L" current			V _I = 0 V, V _{CC} = 5 V		-	-	-5.0	μA
R _{PULLUP}	Pull-up resistance			V _I = 0 V, V _{CC} = 5 V		30	50	167	kΩ
R _{iXIN}	Feedback resistance	XIN			-	1.0	-		MΩ
V _{RAM}	RAM hold voltage			During stop mode		1.8	-	-	V

NOTE:

- V_{CC} = 4.2 to 5.5 V at T_{opr} = -20 to 85°C (N version) / -40 to 85°C (D version), f_(XIN) = 20 MHz, unless otherwise specified.

**Table 5.15 Electrical Characteristics (2) [Vcc = 5 V]
(Topr = -20 to 85°C (N version) / -40 to 85°C (D version), unless otherwise specified.)**

Symbol	Parameter	Condition	Standard			Unit	
			Min.	Typ.	Max.		
Icc	Power supply current (Vcc = 3.3 to 5.5 V) Single-chip mode, output pins are open, other pins are Vss	High-speed clock mode	XIN = 20 MHz (square wave) High-speed on-chip oscillator off Low-speed on-chip oscillator on = 125 kHz No division	-	10	17	mA
			XIN = 16 MHz (square wave) High-speed on-chip oscillator off Low-speed on-chip oscillator on = 125 kHz No division	-	9	15	mA
			XIN = 10 MHz (square wave) High-speed on-chip oscillator off Low-speed on-chip oscillator on = 125 kHz No division	-	6	-	mA
			XIN = 20 MHz (square wave) High-speed on-chip oscillator off Low-speed on-chip oscillator on = 125 kHz Divide-by-8	-	5	-	mA
			XIN = 16 MHz (square wave) High-speed on-chip oscillator off Low-speed on-chip oscillator on = 125 kHz Divide-by-8	-	4	-	mA
			XIN = 10 MHz (square wave) High-speed on-chip oscillator off Low-speed on-chip oscillator on = 125 kHz Divide-by-8	-	2.5	-	mA
		High-speed on-chip oscillator mode	XIN clock off High-speed on-chip oscillator on fOCO = 20 MHz Low-speed on-chip oscillator on = 125 kHz No division	-	10	15	mA
			XIN clock off High-speed on-chip oscillator on fOCO = 20 MHz Low-speed on-chip oscillator on = 125 kHz Divide-by-8	-	4	-	mA
			XIN clock off High-speed on-chip oscillator on fOCO = 10 MHz Low-speed on-chip oscillator on = 125 kHz No division	-	5.5	10	mA
			XIN clock off High-speed on-chip oscillator on fOCO = 10 MHz Low-speed on-chip oscillator on = 125 kHz Divide-by-8	-	2.5	-	mA
		Low-speed on-chip oscillator mode	XIN clock off High-speed on-chip oscillator off Low-speed on-chip oscillator on = 125 kHz Divide-by-8, FMR47 = 1	-	130	300	μA
		Wait mode	XIN clock off High-speed on-chip oscillator off Low-speed on-chip oscillator on = 125 kHz While a WAIT instruction is executed Peripheral clock operation VCA27 = VCA26 = 0 VCA20 = 1	-	25	75	μA
			XIN clock off High-speed on-chip oscillator off Low-speed on-chip oscillator on = 125 kHz While a WAIT instruction is executed Peripheral clock off VCA27 = VCA26 = 0 VCA20 = 1	-	23	60	μA
		Stop mode	XIN clock off, Topr = 25°C High-speed on-chip oscillator off Low-speed on-chip oscillator off CM10 = 1 Peripheral clock off VCA27 = VCA26 = 0	-	0.8	3.0	μA
			XIN clock off, Topr = 85°C High-speed on-chip oscillator off Low-speed on-chip oscillator off CM10 = 1 Peripheral clock off VCA27 = VCA26 = 0	-	1.2	-	μA

Timing Requirements**(Unless Otherwise Specified: $V_{CC} = 5\text{ V}$, $V_{SS} = 0\text{ V}$ at $T_{opr} = 25^\circ\text{C}$) [$V_{CC} = 5\text{ V}$]****Table 5.16 XIN Input**

Symbol	Parameter	Standard		Unit
		Min.	Max.	
$t_{c(XIN)}$	XIN input cycle time	50	–	ns
$t_{WH(XIN)}$	XIN input "H" width	25	–	ns
$t_{WL(XIN)}$	XIN input "L" width	25	–	ns

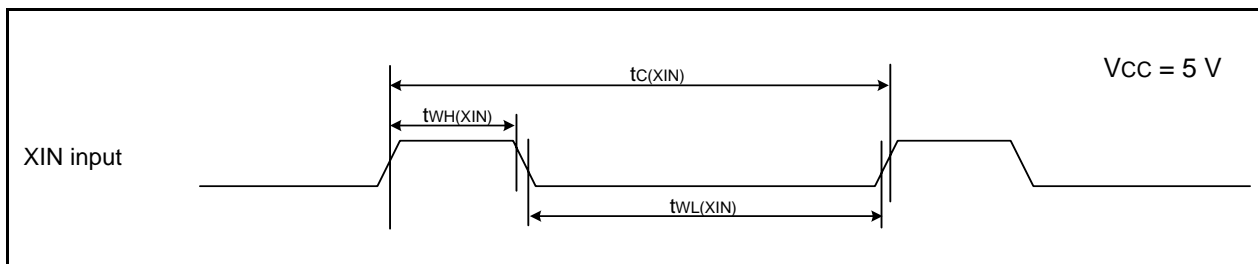
**Figure 5.4 XIN Input Timing Diagram when $V_{CC} = 5\text{ V}$** **Table 5.17 TRAI0 Input**

Symbol	Parameter	Standard		Unit
		Min.	Max.	
$t_{c(TRAIO)}$	TRAIO input cycle time	100	–	ns
$t_{WH(TRAIO)}$	TRAIO input "H" width	40	–	ns
$t_{WL(TRAIO)}$	TRAIO input "L" width	40	–	ns

**Figure 5.5 TRAI0 Input Timing Diagram when $V_{CC} = 5\text{ V}$**

Table 5.18 Serial Interface

Symbol	Parameter	Standard		Unit
		Min.	Max.	
$t_{c(CK)}$	CLK0 input cycle time	200	–	ns
$t_{w(CKH)}$	CLK0 input “H” width	100	–	ns
$t_{w(CKL)}$	CLK0 input “L” width	100	–	ns
$t_{d(C-Q)}$	TXD0 output delay time	–	50	ns
$t_{h(C-Q)}$	TXD0 hold time	0	–	ns
$t_{su(D-C)}$	RXD0 input setup time	50	–	ns
$t_{h(C-D)}$	RXD0 input hold time	90	–	ns

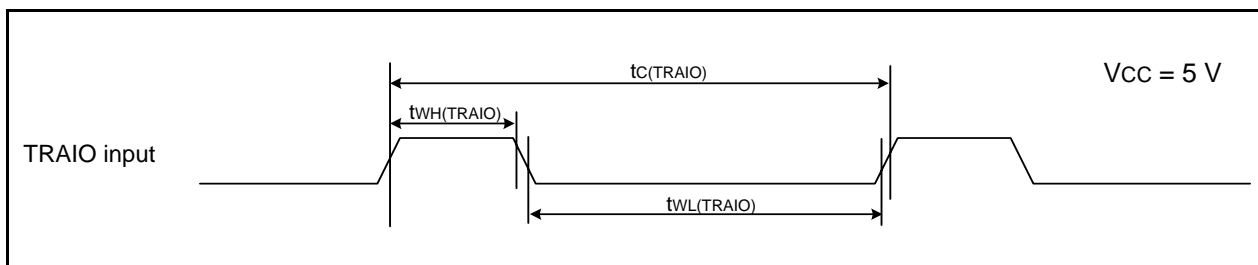
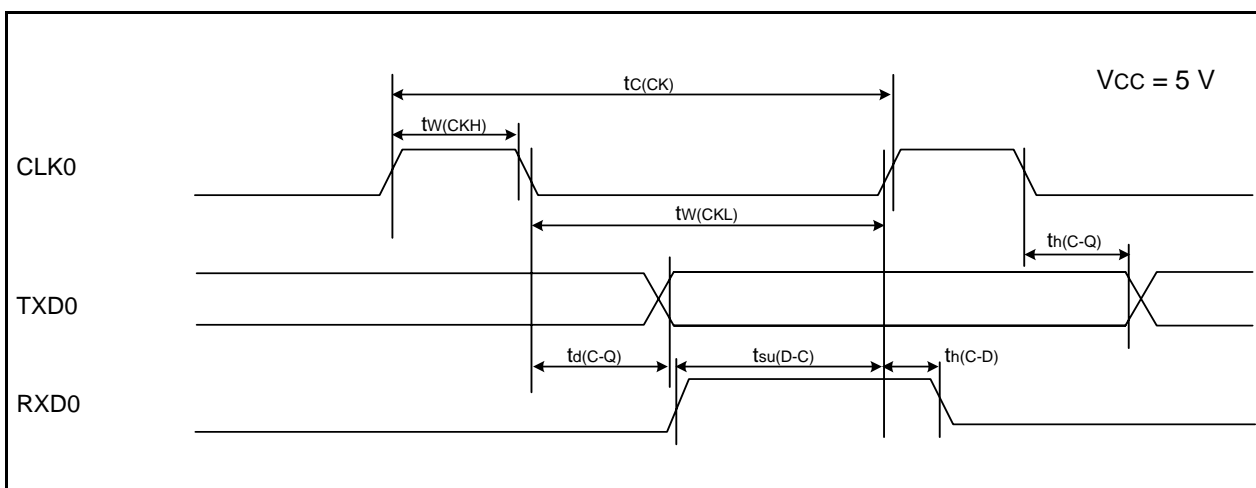

Figure 5.6 Serial Interface Timing Diagram when Vcc = 5 V

Table 5.19 External Interrupt \overline{INTi} ($i = 0, 1, 3$) Input

Symbol	Parameter	Standard		Unit
		Min.	Max.	
$t_{w(INH)}$	\overline{INTi} input “H” width	250 ⁽¹⁾	–	ns
$t_{w(INL)}$	\overline{INTi} input “L” width	250 ⁽²⁾	–	ns

NOTES:

1. When selecting the digital filter by the \overline{INTi} input filter select bit, use an \overline{INTi} input HIGH width of either (1/digital filter clock frequency × 3) or the minimum value of standard, whichever is greater.
2. When selecting the digital filter by the \overline{INTi} input filter select bit, use an \overline{INTi} input LOW width of either (1/digital filter clock frequency × 3) or the minimum value of standard, whichever is greater.

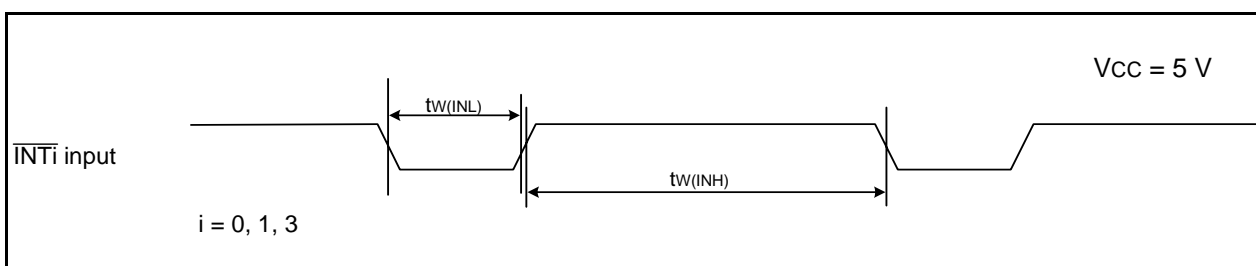

Figure 5.7 External Interrupt \overline{INTi} Input Timing Diagram when Vcc = 5 V

Table 5.20 Electrical Characteristics (3) [V_{CC} = 3 V]

Symbol	Parameter		Condition		Standard			Unit
					Min.	Typ.	Max.	
V _{OH}	Output "H" voltage	Except P1_0 to P1_7, XOUT	I _{OH} = -1 mA		V _{CC} - 0.5	-	V _{CC}	V
		P1_0 to P1_7	Drive capacity HIGH	I _{OH} = -2 mA	V _{CC} - 0.5	-	V _{CC}	V
			Drive capacity LOW	I _{OH} = -1 mA	V _{CC} - 0.5	-	V _{CC}	V
		XOUT	Drive capacity HIGH	I _{OH} = -0.1 mA	V _{CC} - 0.5	-	V _{CC}	V
			Drive capacity LOW	I _{OH} = -50 μA	V _{CC} - 0.5	-	V _{CC}	V
V _{OL}	Output "L" voltage	Except P1_0 to P1_7, XOUT	I _{OL} = 1 mA		-	-	0.5	V
		P1_0 to P1_7	Drive capacity HIGH	I _{OL} = 2 mA	-	-	0.5	V
			Drive capacity LOW	I _{OL} = 1 mA	-	-	0.5	V
		XOUT	Drive capacity HIGH	I _{OL} = 0.1 mA	-	-	0.5	V
			Drive capacity LOW	I _{OL} = 50 μA	-	-	0.5	V
V _{T+} -V _{T-}	Hysteresis	$\overline{\text{INT0}}, \overline{\text{INT1}}, \overline{\text{INT3}},$ $\overline{\text{KI0}}, \overline{\text{KI1}}, \overline{\text{KI2}}, \overline{\text{KI3}},$ $\overline{\text{TRAIO}}, \overline{\text{RXD0}}, \overline{\text{CLK0}}$			0.1	0.3	-	V
		$\overline{\text{RESET}}$			0.1	0.4	-	V
I _{IH}	Input "H" current		V _I = 3 V, V _{CC} = 3 V		-	-	4.0	μA
I _{IL}	Input "L" current		V _I = 0 V, V _{CC} = 3 V		-	-	-4.0	μA
R _{PULLUP}	Pull-up resistance		V _I = 0 V, V _{CC} = 3 V		66	160	500	kΩ
R _{fXIN}	Feedback resistance	XIN			-	3.0	-	MΩ
V _{RAM}	RAM hold voltage		During stop mode		1.8	-	-	V

NOTE:

- V_{CC} = 2.7 to 3.3 V at T_{opr} = -20 to 85°C (N version) / -40 to 85°C (D version), f_(XIN) = 10 MHz, unless otherwise specified.

Table 5.21 Electrical Characteristics (4) [V_{CC} = 3 V]
(T_{opr} = -20 to 85°C (N version) / -40 to 85°C (D version), unless otherwise specified.)

Symbol	Parameter	Condition	Standard			Unit	
			Min.	Typ.	Max.		
I _{CC}	Power supply current (V _{CC} = 2.7 to 3.3 V) Single-chip mode, output pins are open, other pins are V _{SS}	High-speed clock mode	XIN = 10 MHz (square wave) High-speed on-chip oscillator off Low-speed on-chip oscillator on = 125 kHz No division	–	6	–	mA
			XIN = 10 MHz (square wave) High-speed on-chip oscillator off Low-speed on-chip oscillator on = 125 kHz Divide-by-8	–	2	–	mA
		High-speed on-chip oscillator mode	XIN clock off High-speed on-chip oscillator on f _{OCO} = 10 MHz Low-speed on-chip oscillator on = 125 kHz No division	–	5	9	mA
			XIN clock off High-speed on-chip oscillator on f _{OCO} = 10 MHz Low-speed on-chip oscillator on = 125 kHz Divide-by-8	–	2	–	mA
		Low-speed on-chip oscillator mode	XIN clock off High-speed on-chip oscillator off Low-speed on-chip oscillator on = 125 kHz Divide-by-8, FMR47 = 1	–	130	300	μA
		Wait mode	XIN clock off High-speed on-chip oscillator off Low-speed on-chip oscillator on = 125 kHz While a WAIT instruction is executed Peripheral clock operation VCA27 = VCA26 = 0 VCA20 = 1	–	25	70	μA
			XIN clock off High-speed on-chip oscillator off Low-speed on-chip oscillator on = 125 kHz While a WAIT instruction is executed Peripheral clock off VCA27 = VCA26 = 0 VCA20 = 1	–	23	55	μA
		Stop mode	XIN clock off, T _{opr} = 25°C High-speed on-chip oscillator off Low-speed on-chip oscillator off CM10 = 1 Peripheral clock off VCA27 = VCA26 = 0	–	0.7	3.0	μA
			XIN clock off, T _{opr} = 85°C High-speed on-chip oscillator off Low-speed on-chip oscillator off CM10 = 1 Peripheral clock off VCA27 = VCA26 = 0	–	1.1	–	μA

Timing requirements**(Unless Otherwise Specified: $V_{CC} = 3\text{ V}$, $V_{SS} = 0\text{ V}$ at $T_{opr} = 25^{\circ}\text{C}$) [$V_{CC} = 3\text{ V}$]****Table 5.22 XIN Input**

Symbol	Parameter	Standard		Unit
		Min.	Max.	
$t_{c(XIN)}$	XIN input cycle time	100	–	ns
$t_{WH(XIN)}$	XIN input "H" width	40	–	ns
$t_{WL(XIN)}$	XIN input "L" width	40	–	ns

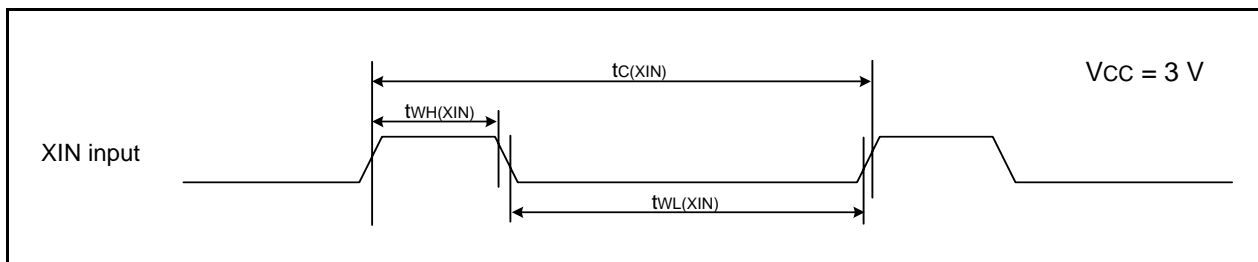
**Figure 5.8 XIN Input Timing Diagram when $V_{CC} = 3\text{ V}$** **Table 5.23 TRAIO Input**

Symbol	Parameter	Standard		Unit
		Min.	Max.	
$t_{c(TRAIO)}$	TRAIO input cycle time	300	–	ns
$t_{WH(TRAIO)}$	TRAIO input "H" width	120	–	ns
$t_{WL(TRAIO)}$	TRAIO input "L" width	120	–	ns

**Figure 5.9 TRAIO Input Timing Diagram when $V_{CC} = 3\text{ V}$**

Table 5.24 Serial Interface

Symbol	Parameter	Standard		Unit
		Min.	Max.	
$t_c(\text{CK})$	CLK0 input cycle time	300	–	ns
$t_w(\text{CKH})$	CLK0 input “H” width	150	–	ns
$t_w(\text{CKL})$	CLK0 Input “L” width	150	–	ns
$t_d(\text{C-Q})$	TXD0 output delay time	–	80	ns
$t_h(\text{C-Q})$	TXD0 hold time	0	–	ns
$t_{su}(\text{D-C})$	RXD0 input setup time	70	–	ns
$t_h(\text{C-D})$	RXD0 input hold time	90	–	ns

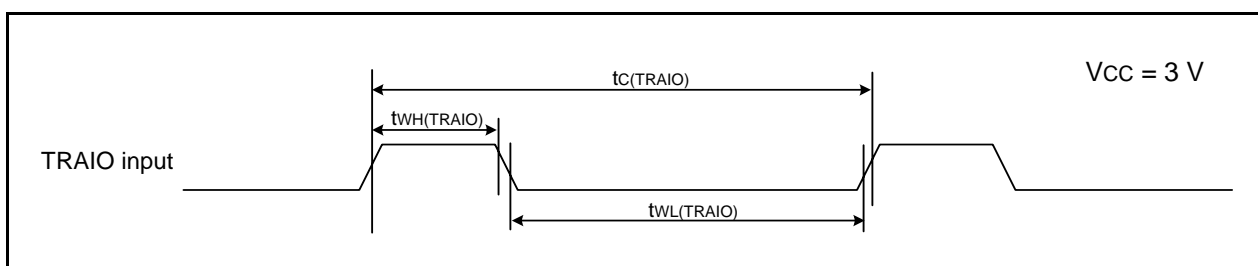
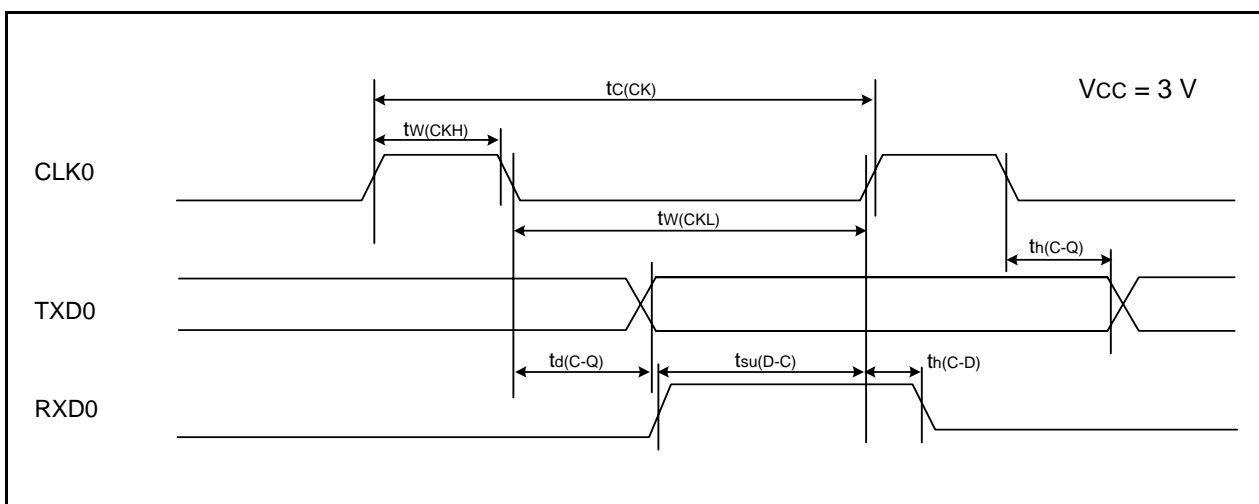

Figure 5.10 Serial Interface Timing Diagram when Vcc = 3 V

Table 5.25 External Interrupt $\overline{\text{INT}}_i$ ($i = 0, 1, 3$) Input

Symbol	Parameter	Standard		Unit
		Min.	Max.	
$t_w(\text{INH})$	$\overline{\text{INT}}_i$ input “H” width	380 ⁽¹⁾	–	ns
$t_w(\text{INL})$	$\overline{\text{INT}}_i$ input “L” width	380 ⁽²⁾	–	ns

NOTES:

1. When selecting the digital filter by the $\overline{\text{INT}}_i$ input filter select bit, use an $\overline{\text{INT}}_i$ input HIGH width of either (1/digital filter clock frequency × 3) or the minimum value of standard, whichever is greater.
2. When selecting the digital filter by the $\overline{\text{INT}}_i$ input filter select bit, use an $\overline{\text{INT}}_i$ input LOW width of either (1/digital filter clock frequency × 3) or the minimum value of standard, whichever is greater.

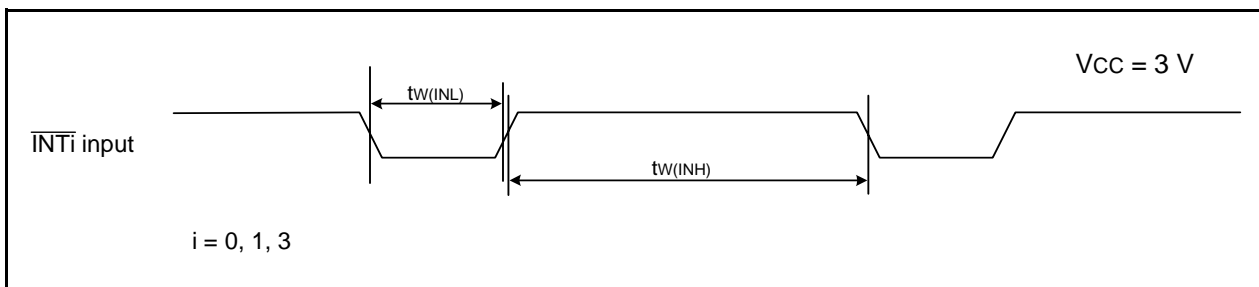
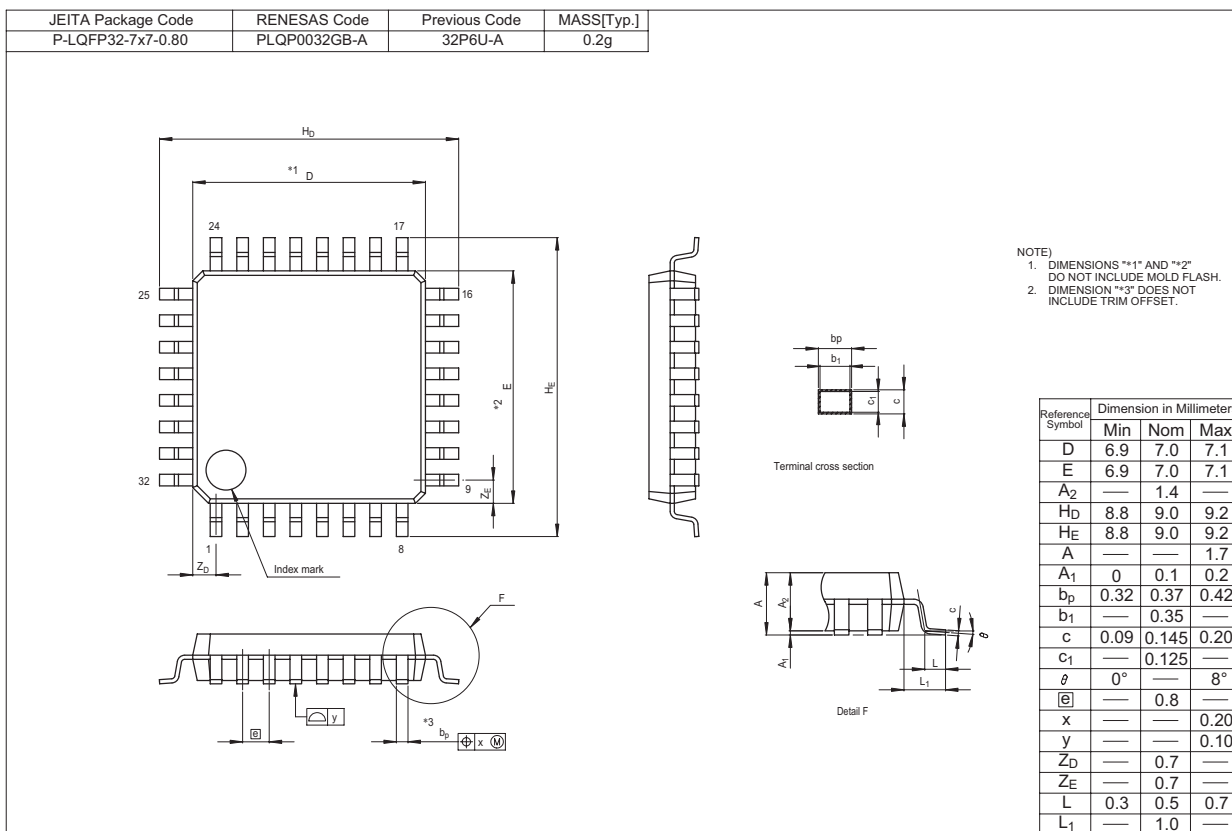

Figure 5.11 External Interrupt $\overline{\text{INT}}_i$ Input Timing Diagram when Vcc = 3 V

Package Dimensions

Diagrams showing the latest package dimensions and mounting information are available in the “Packages” section of the Renesas Technology website.



REVISION HISTORY	R8C/2E Group, R8C/2F Group Datasheet
------------------	--------------------------------------

Rev.	Date	Description	
		Page	Summary
0.10	Aug 01, 2007	–	First Edition issued
1.00	Dec 14, 2007	All pages 2, 4 6, 7 15, 16 17 24 30	“Under development” deleted Table 1.1, Table 1.3: “Interrupts” revised Table 1.5, Table 1.6: “(D)” deleted Figure 3.1, Figure 3.2: “Expanded area” deleted Table 4.1: “002Ch” added Table 5.2: I _{OH} (sum), NOTE2 revised Table 5.11: Symbol “fOCO40M”; Parameter added

All trademarks and registered trademarks are the property of their respective owners.

Notes:

1. This document is provided for reference purposes only so that Renesas customers may select the appropriate Renesas products for their use. Renesas neither makes warranties or representations with respect to the accuracy or completeness of the information contained in this document nor grants any license to any intellectual property rights or any other rights of Renesas or any third party with respect to the information in this document.
2. Renesas shall have no liability for damages or infringement of any intellectual property or other rights arising out of the use of any information in this document, including, but not limited to, product data, diagrams, charts, programs, algorithms, and application circuit examples.
3. You should not use the products or the technology described in this document for the purpose of military applications such as the development of weapons of mass destruction or for the purpose of any other military use. When exporting the products or technology described herein, you should follow the applicable export control laws and regulations, and procedures required by such laws and regulations.
4. All information included in this document such as product data, diagrams, charts, programs, algorithms, and application circuit examples, is current as of the date this document is issued. Such information, however, is subject to change without any prior notice. Before purchasing or using any Renesas products listed in this document, please confirm the latest product information with a Renesas sales office. Also, please pay regular and careful attention to additional and different information to be disclosed by Renesas such as that disclosed through our website. (<http://www.renesas.com>)
5. Renesas has used reasonable care in compiling the information included in this document, but Renesas assumes no liability whatsoever for any damages incurred as a result of errors or omissions in the information included in this document.
6. When using or otherwise relying on the information in this document, you should evaluate the information in light of the total system before deciding about the applicability of such information to the intended application. Renesas makes no representations, warranties or guarantees regarding the suitability of its products for any particular application and specifically disclaims any liability arising out of the application and use of the information in this document or Renesas products.
7. With the exception of products specified by Renesas as suitable for automobile applications, Renesas products are not designed, manufactured or tested for applications or otherwise in systems the failure or malfunction of which may cause a direct threat to human life or create a risk of human injury or which require especially high quality and reliability such as safety systems, or equipment or systems for transportation and traffic, healthcare, combustion control, aerospace and aeronautics, nuclear power, or undersea communication transmission. If you are considering the use of our products for such purposes, please contact a Renesas sales office beforehand. Renesas shall have no liability for damages arising out of the uses set forth above.
8. Notwithstanding the preceding paragraph, you should not use Renesas products for the purposes listed below:
 - (1) artificial life support devices or systems
 - (2) surgical implantations
 - (3) healthcare intervention (e.g., excision, administration of medication, etc.)
 - (4) any other purposes that pose a direct threat to human lifeRenesas shall have no liability for damages arising out of the uses set forth in the above and purchasers who elect to use Renesas products in any of the foregoing applications shall indemnify and hold harmless Renesas Technology Corp., its affiliated companies and their officers, directors, and employees against any and all damages arising out of such applications.
9. You should use the products described herein within the range specified by Renesas, especially with respect to the maximum rating, operating supply voltage range, movement power voltage range, heat radiation characteristics, installation and other product characteristics. Renesas shall have no liability for malfunctions or damages arising out of the use of Renesas products beyond such specified ranges.
10. Although Renesas endeavors to improve the quality and reliability of its products, IC products have specific characteristics such as the occurrence of failure at a certain rate and malfunctions under certain use conditions. Please be sure to implement safety measures to guard against the possibility of physical injury, and injury or damage caused by fire in the event of the failure of a Renesas product, such as safety design for hardware and software including but not limited to redundancy, fire control and malfunction prevention, appropriate treatment for aging degradation or any other applicable measures. Among others, since the evaluation of microcomputer software alone is very difficult, please evaluate the safety of the final products or system manufactured by you.
11. In case Renesas products listed in this document are detached from the products to which the Renesas products are attached or affixed, the risk of accident such as swallowing by infants and small children is very high. You should implement safety measures so that Renesas products may not be easily detached from your products. Renesas shall have no liability for damages arising out of such detachment.
12. This document may not be reproduced or duplicated, in any form, in whole or in part, without prior written approval from Renesas.
13. Please contact a Renesas sales office if you have any questions regarding the information contained in this document, Renesas semiconductor products, or if you have any other inquiries.



RENESAS SALES OFFICES

<http://www.renesas.com>

Refer to "<http://www.renesas.com/en/network>" for the latest and detailed information.

Renesas Technology America, Inc.
450 Holger Way, San Jose, CA 95134-1368, U.S.A
Tel: <1> (408) 382-7500, Fax: <1> (408) 382-7501

Renesas Technology Europe Limited
Dukes Meadow, Millboard Road, Bourne End, Buckinghamshire, SL8 5FH, U.K.
Tel: <44> (1628) 585-100, Fax: <44> (1628) 585-900

Renesas Technology (Shanghai) Co., Ltd.
Unit 204, 205, AZIACenter, No.1233 Lujiazui Ring Rd, Pudong District, Shanghai, China 200120
Tel: <86> (21) 5877-1818, Fax: <86> (21) 6887-7858/7898

Renesas Technology Hong Kong Ltd.
7th Floor, North Tower, World Finance Centre, Harbour City, Canton Road, Tsimshatsui, Kowloon, Hong Kong
Tel: <852> 2265-6688, Fax: <852> 2377-3473

Renesas Technology Taiwan Co., Ltd.
10th Floor, No.99, Fushing North Road, Taipei, Taiwan
Tel: <886> (2) 2715-2888, Fax: <886> (2) 3518-3399

Renesas Technology Singapore Pte. Ltd.
1 Harbour Front Avenue, #06-10, Keppel Bay Tower, Singapore 098632
Tel: <65> 6213-0200, Fax: <65> 6278-8001

Renesas Technology Korea Co., Ltd.
Kukje Center Bldg. 18th Fl., 191, 2-ka, Hangang-ro, Yongsan-ku, Seoul 140-702, Korea
Tel: <82> (2) 796-3115, Fax: <82> (2) 796-2145

Renesas Technology Malaysia Sdn. Bhd
Unit 906, Block B, Menara Amcorp, Amcorp Trade Centre, No.18, Jln Persiaran Barat, 46050 Petaling Jaya, Selangor Darul Ehsan, Malaysia
Tel: <603> 7955-9390, Fax: <603> 7955-9510