

**NOTE**



All numerical values are in metric units [with U.S. customary units in brackets]. Dimensions are in millimeters [and inches]. Unless otherwise specified, dimensions have a tolerance of  $\pm 0.13$  [ $\pm .005$ ] and angles have a tolerance of  $\pm 2^\circ$ . Figures and illustrations are for identification only and are not drawn to scale.

**1. INTRODUCTION**

This specification covers the requirements for application of AMPMODU MT Interconnection System for wire-to-printed circuit (pc) board applications. This system consists of receptacle and right angle pin header connectors. These connectors have a double row of contact cavities with row-to-row and in-row contact spacing on  $2.54 \times 2.54$  mm [ $.100 \times .100$  in.] centerlines. The receptacles are available pre-loaded with standard pressure insulation displacement contacts in 6 through 64 positions or high pressure insulation displacement contacts in 6 through 20 positions. The receptacles are also available unloaded with 6 through 64 positions which accept standard pressure or high pressure insulation displacement contacts. Each receptacle is marked at the mating end with position one identifier.

**NOTE**



Unloaded receptacles will also accept crimp snap-in contacts if a larger wire insulation outside diameter or two-wire circuit application is required. Contact the Product Information Center at the number at the bottom of this page for recommendations.

The receptacle contact cavities each feature a locking lance window for positive polarization for inserting contacts. A front and back cover must be installed onto the receptacle to protect the terminated wires and contacts. The covers are available in low profile and standard profile.

The pin headers are available in 6, 8, 10, 16, 18, 20, 26, and 50 positions and contain 0.64 mm [.025 in.] square post through hole solder type contacts for pc board applications. These pin headers have an effective contact post length of 6.93 mm [.273 in.]. The housing features standoffs to allow easy pc board cleaning after soldering. No tooling is required for placement of the pin headers onto the pc board.

When corresponding with Tyco Electronics Personnel, use the terminology provided in this specification to facilitate your inquiries for information. Basic terms and features of this product are provided in Figure 1.

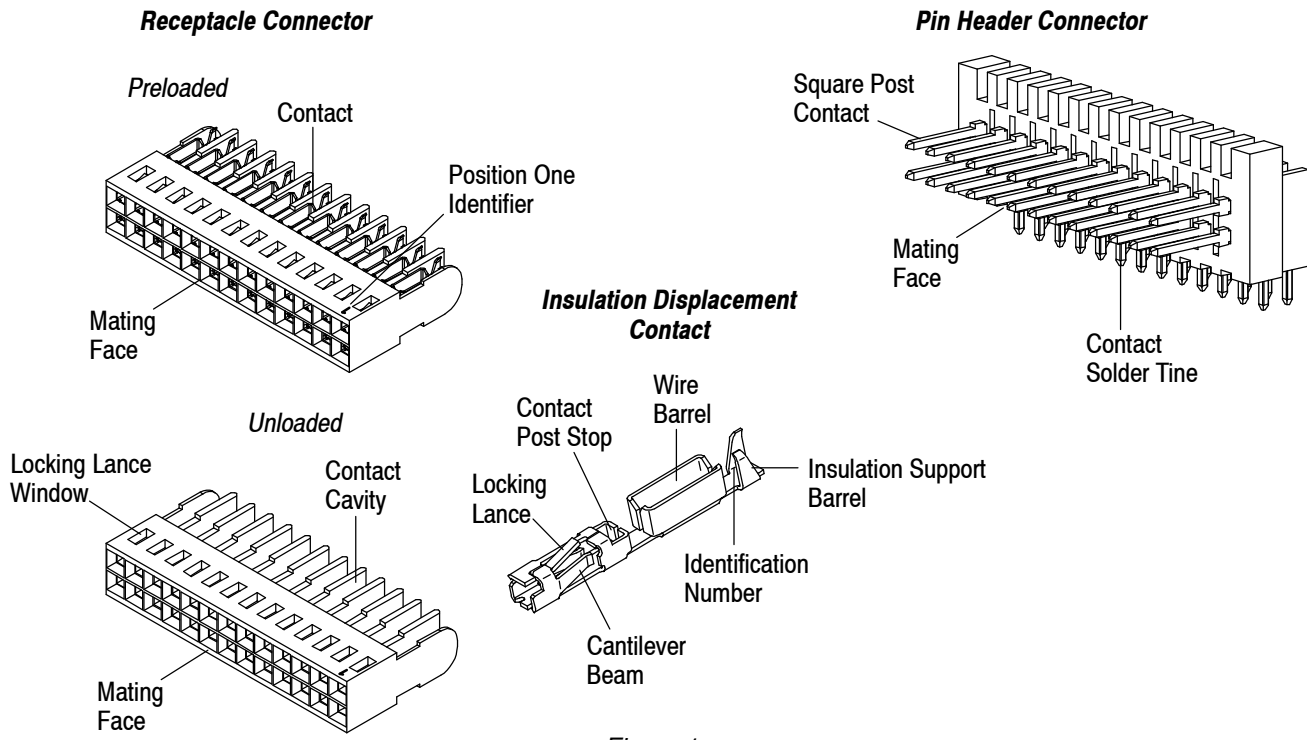


Figure 1

The insulation displacement contacts have a stamped identification number that corresponds to a given wire size range and indicates a standard pressure or high pressure contact as listed in Figure 2.

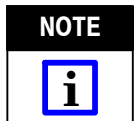
WIRE SIZE RANGE (AWG)	CONTACT IDENTIFICATION NUMBER	
	STANDARD PRESSURE	HIGH PRESSURE
30-26	1	4
26-22	2	5
22-20	3	---

Figure 2

These contacts feature a locking lance designed to secure the contact in the receptacle contact cavity. The contacts are terminated within the receptacle using the insulation displacement technique where a discrete wire is inserted into the slotted wire barrel to form an electrical connection between contact and wire. During termination, the insulation support barrel is formed around the wire insulation. The integral cantilever beams accept the mating square post contact, and the contact post stop prevents over-insertion of the contact. These contacts are available in loose piece only.

Add-on shielding can be installed to reduce electromagnetic interference/electrostatic discharge (EMI/ESD) at the input-output interface of the connectors. Shielding for receptacles is available with straight cable exit or right angle cable exit. The connectors can be uniquely identified with keying plugs to prevent inadvertent mating of similar connectors.

The receptacles with standard pressure contacts will accept mating pin header contact post length range of 5.64 through 6.93 mm [.222 through .273 in.] and receptacles with high pressure contacts will accept 5.08 through 6.93 mm [.200 through .273 in.].



*Unshielded receptacles will also mate with AMPMODU standard profile pin headers and AMP-LATCH\* ejection pin headers with certain features. These pin headers are part of related product lines but are not covered in this document. Contact the Product Information Center at the number at the bottom of page 1 for recommendations.*

**2. REFERENCE MATERIAL**

**2.1. Revision Summary**

- Update document to corporate requirements
- New logo and format

**2.2. Customer Assistance**

Product Part Number 102393 and Product Code 5216 are representative of AMPMODU MT Interconnection System. Use of these numbers will identify the product line and expedite your inquiries through a service network established to help you obtain product and tooling information. Such information can be obtained through a local Tyco Electronics Representative or, after purchase, by calling the Product Information Center at the number at the bottom of page 1.

**2.3. Drawings**

Customer Drawings for product part numbers are available from the service network. If there is a conflict between the information contained in the Customer Drawings and this specification or with any other technical documentation supplied, call the Product Information Center at the number at the bottom of page 1.

**2.4. Manuals**

Manual 402-40 is available upon request and can be used as a guide to soldering. This manual provides information on various flux types and characteristics with the commercial designation and flux removal procedures. A checklist is included in the manual as a guide for information on soldering problems.

**2.5. Specifications**

Workmanship Specification 101-2 and Test Specification 109-11 provides solderability requirements and evaluation methods.

Product Specifications (108-series) provide product performance and test information, and Application Specifications (114-series) provide product description and application requirements. Documents available which pertain to this product are:

- 108-25015 AMPMODU Mass Terminated Standard Pressure Connectors
- 108-25018 AMPMODU Mass Terminated High Pressure Connectors
- 108-25030 AMPMODU MT Shielding
- 114-25003 AMPMODU Mod IV, IV<sup>1/2</sup>, and V Receptacles and Housings

## 2.6. Instructional Material

Instruction Sheets (408-series) provide assembly instructions and Customer Manuals (409-series) provide machine setup and operation procedures. Documents available which pertain to this product are:

### A. Product

- 408-6532 AMPMODU MT Connectors

### B. Tooling

- 408-6574 Ribbon Cable Cutting Hand Tool 91220-1
- 408-6789 Pistol Grip Pneumatic Handle Assembly 58075-1
- 408-6790 Pistol Grip Manual Handle Assembly 58074-1
- 408-6837 Hand Crimping Tool 91410-1
- 408-6923 Manual Arbor Frame Assembly 58024-1
- 408-7763 Pneumatic Applicator Frame Assembly 91112-2
- 408-7777 Manual Arbor Frame Assembly 91085-2
- 408-8083 Ferrule Applicator Assembly 812407-1
- 408-9028 Tooling Assembly 91411-2
- 408-9085 Terminating Head 58062-1
- 408-9138 Pneumatic Upper Tool Mount 527145-1 and Discrete Wire Organizer Assembly 527085-1
- 408-9393 Pneumatic Power Bench Assembly 58338-1
- 408-9453 Extraction/Lance Reset Tool 843477-3
- 408-9454 Keying Tool 843853-1
- 408-9515 Ribbon Cable Notcher 854449-[ ]
- 408-9678 Tooling Kit 1-762661-0
- 408-9687 Adapter Kit 854468-[ ] for Ribbon Cable Notcher 854449-[ ]
- 409-5128 AMP-O-ELECTRIC\* Model "K" Terminator Machines 565435-5 and 2-565435-2
- 409-5746 Electric Power Unit 931800-1
- 409-5839 CHAMPOMATOR\* 2.5 Bench Terminating Machine 354786-[ ]
- 409-5843 2700-lb Pneumatic Power Unit 312522-1

## 3. REQUIREMENTS

### 3.1. Safety

Do not stack component packages so high that the shipping containers buckle or deform.

### 3.2. Limitations

Connector assemblies are designed to operate in a temperature range of -65° to 105°C [-85° to 221°F].

### 3.3. Material

The connector housings are made of flame retardant thermoplastic. The insulation displacement contacts (of receptacles) are made of copper alloy underplated with nickel, contact area is plated with gold, and crimp area is plated with tin-lead. Square post contacts (of pin headers) are made of copper alloy plated with gold over nickel. The covers are made of flame retardant thermoplastic. The shielding is made of pre-tinned copper alloy and shield ferrule is made of soft copper plated with tin. Keying plugs are made of nylon.

### 3.4. Storage

#### A. Ultraviolet Light

Prolonged exposure to ultraviolet light may deteriorate the chemical composition used in the connector housing material.

**B. Shelf Life**

The connectors should remain in the shipping containers until ready for use to prevent deformation to the connectors. The connectors should be used on a first in, first out basis to avoid storage contamination that could adversely affect performance.

**C. Chemical Exposure**

Do not store connectors near any chemical listed below as they may cause stress corrosion cracking in the connectors.


Alkalies	Ammonia	Citrates	Phosphates	Citrates	Sulfur Compounds
Amines	Carbonates	Nitrites	Sulfur Nitrites		Tartrates

**3.5. Cable and Discrete Wire Selection and Preparation**

**A. Selection**

The contacts accept solid or stranded discrete wire, unshielded or shielded jacketed cable, or 1.27 mm [.050 in.] or 2.54 mm [.100 in.] centerline ribbon cable with wire size range of 30 through 20 AWG (for discrete wire) and 28 through 22 AWG (for ribbon cable), and maximum insulation outside diameter of 1.27 mm [.050 in.] and maximum wall thickness of 0.38 mm [.015 in.]. Jacketed cable must have an outside diameter range of 4.32 through 15.2 mm [.170 through .600 in.], and the shield must be braided (foil cannot be used). Individual wire insulation must be made of polyvinylchloride or polytetraflouroethylene.


**NOTE** *For cable containing more than seven-strand wire, or for other insulation materials, contact the Product Information Center at the number at the bottom of page 1 for recommendations.*



**B. Preparation**

There is no preparation required for discrete wire. Proper strip length for jacketed cable is necessary to properly insert individual wires into the contact. The strip length of jacketed cable is shown in Figure 3. After stripping, the cable braid must be slightly flared.

**CAUTION** *Reasonable care must be taken not to nick, scrape, or cut individual wire insulation during the stripping operation.*




Ribbon cable must be cut perpendicular to the length of the cable, then individual wires separated to the dimensions shown in Figure 4.

**3.6. Receptacle**

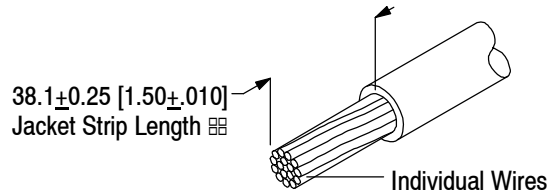
**A. Loading (Unloaded Receptacles)**

The contact locking lance must align with the receptacle locking lance window, then inserted straight into the contact cavity. When properly inserted, there will be an audible “click.”

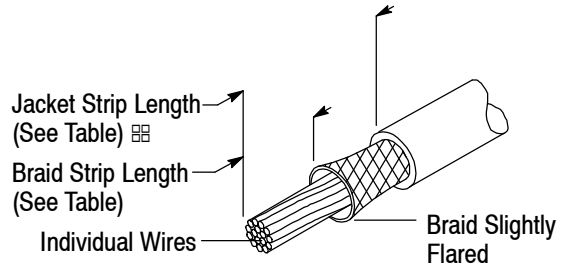
**NOTE** *If necessary, the contacts can be removed, using the tooling listed in Section 5.*



**Unshielded Jacketed Cable Strip Length**



**Shielded Jacketed Cable Strip Length**



**Note:** Not to Scale

CONNECTOR SIZE (No. of Positions)	SHIELDED JACKETED CABLE STRIP LENGTH* ±0.25 [±.010]		
	JACKET		BRAID
	If Using Straight Cable Exit Shielding	If Using Right Angle Cable Exit Shielding	
6	25.65 [1.010]	—	6.35 [.250]
10	35.81 [1.410]	—	8.89 [.350]
16	42.93 [1.690]	—	8.89 [.350]
18	—	53.59 [2.110]	8.89 [.350]
26	44.70 [1.760]	65.02 [2.560]	11.43 [.450]
40	60.71 [2.390]	82.53 [3.210]	
50	65.02 [2.560]	89.92 [3.540]	
60	—	104.90 [4.130]	

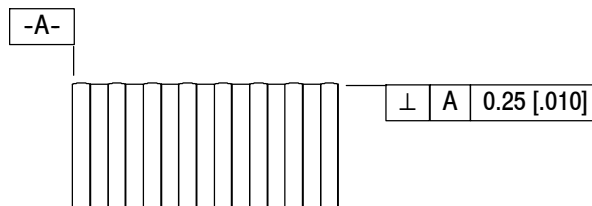
⊞ Add 76.2 mm [3.00 in.] to jacket strip length if using CHAMPOMATOR\* 2.5 Bench Terminating Machine 354786-[ ] or Tooling Assembly 91411-2 for terminating.

▪ Dimensions are typical. The strip lengths will vary according to length needed to dress wires.

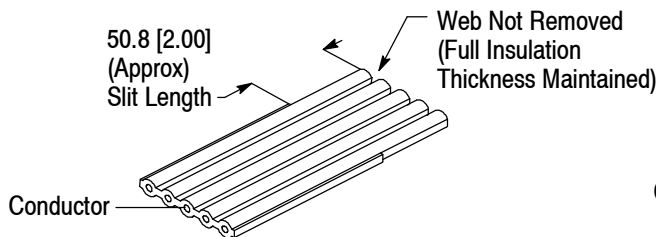
Figure 3

**Ribbon Cable Cut**

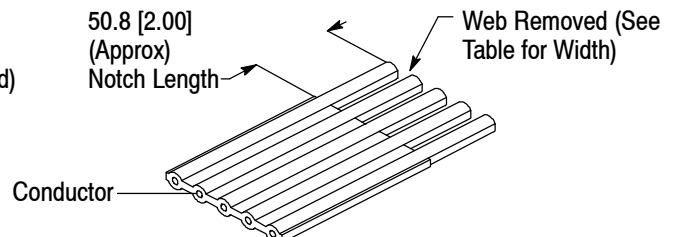
**Note:** Not to Scale



**1.27 [.050] Centerline Ribbon Cable Slit**



**2.54 [.100] Centerline Ribbon Cable Notch**



WIRE SIZE (AWG)	WIDTH OF WEB REMOVED
28-26	1.42 [.056]
24-22	1.27 [.050]

Figure 4

**B. Termination**



Wire insulation (excluding sections seated in wire barrel slots) or cable jacket must NOT be cut or broken during the termination process.

Receptacles must be terminated to discrete wire or cable according to instructions packaged with applicable tooling. The terminated receptacle must meet the following requirements. See Figure 5.

1. There is no evidence of damage to the receptacle housing, contact cavities, or contacts.
2. There is no deformation to the contact wire barrels.
3. Each contact insulation support barrel is fully closed and wrapped around the wire insulation just enough to prevent the wire from separating from the wire slots. The arms of the insulation support barrel must not cross each other. Pierced insulation is acceptable.
4. Each wire is straight and fully seated in the wire barrel with the top of the conductor(s) below the top of the wire barrel slot.
5. The end of each wire extends beyond the end of the wire barrel to at least the minimum dimension shown in Figure 5 or butts against the post stop.

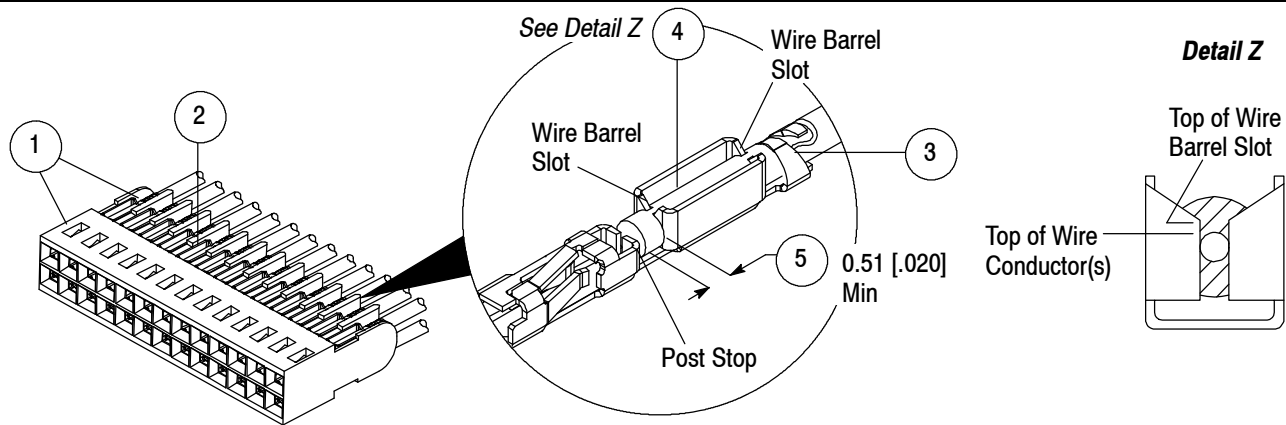


Figure 5

**C. Cover**

Each receptacle requires a front and a back cover. The mating covers must be compatible and appropriate for the application. Refer to Figure 6.



For shielded applications, only non-polarizing front cover and shielding or shielding and non-shielding back cover can be used.

APPLICATION	COVER		
	PROFILE	FRONT	BACK
Non-Shielded	Low	Polarizing	Shielding and Non-Shielding
		Latching	
		Ejection	
		Non-Polarizing	
	Non-Polarizing	Shielding	
Standard	Standard	Hermaphroditic	Hermaphroditic
		Ejection	Ejection
Shielded	Low	Non-Polarizing	Shielding
			Shielding and Non-Shielding

Figure 6

The cover installed onto the receptacle must meet the following requirements. Refer to Figure 7.

1. The tabs on the front and back covers are inserted into the back of the receptacle contact cavities.
2. For covers with locating posts, each slot must contain the appropriate wire. For covers with locking latches, wires must be within the locking latches.

**NOTE**

*Each slot for the low profile shielding and non-shielding back cover must only contain a maximum of two wires.*



3. The cover locking latches or locating posts fully engage each other.
4. There are no wires pinched between the receptacle and the covers.
5. For shielded applications, the back cover must be installed onto the side of the receptacle that sits against the inner shell of the shield.

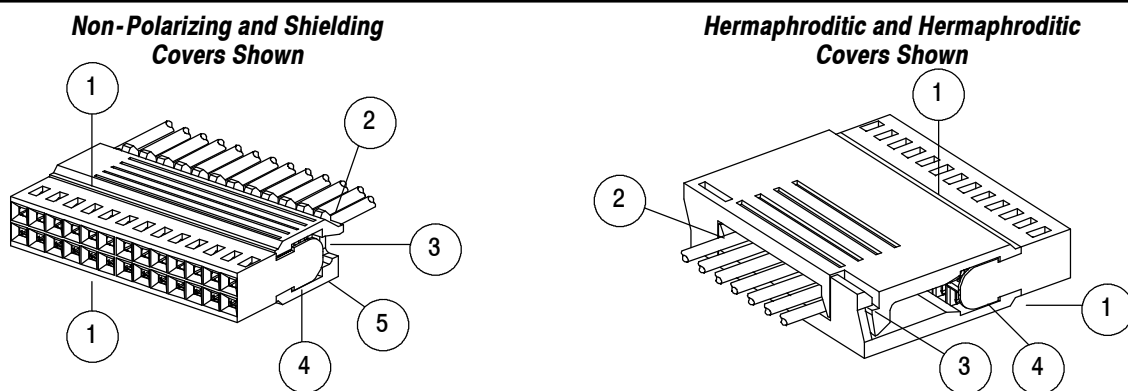


Figure 7

#### D. Shielding

Shielding components for the receptacle consist of a (male) inner shell, (female) outer shell, and straight or step-down ferrule.

**NOTE**

*Only certain right angle cable exit shielding feature a hole (located on top of the outer shell) for a cable tie pull ring. A pull ring can be installed onto the assembly and used to aid in unmating the connectors. For proper use, the pull ring must be installed before assembling the outer shell onto the receptacle.*



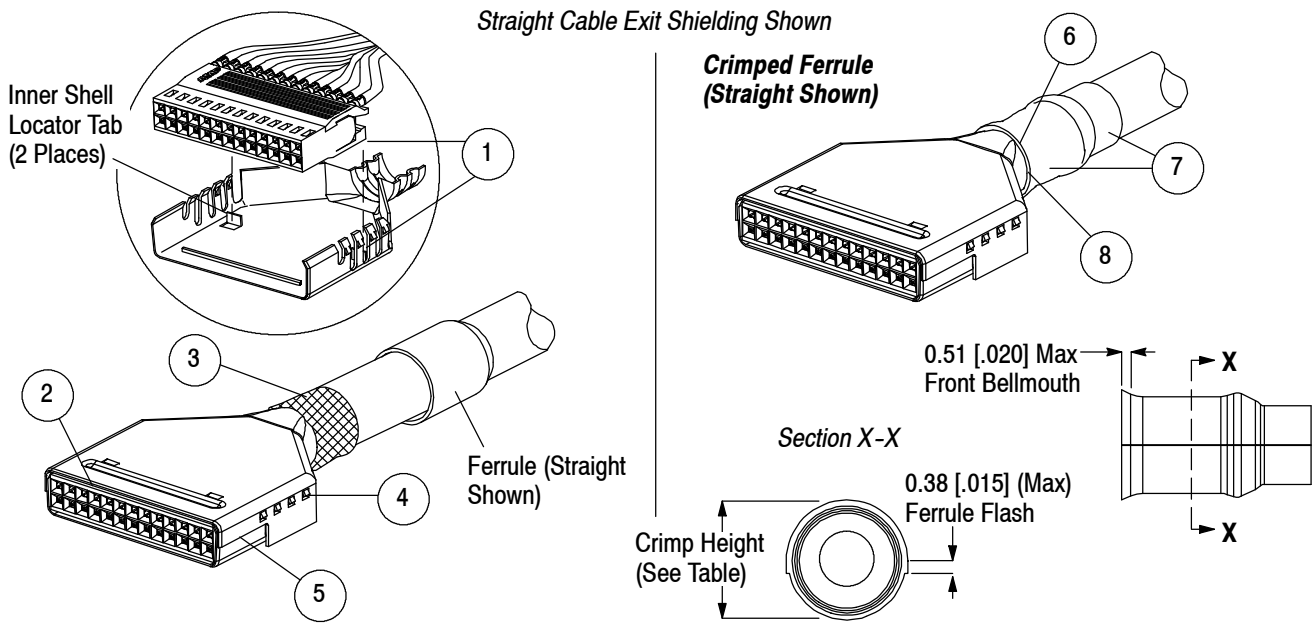
The assembled shielding for receptacles must meet the following requirements. See Figure 8.

**NOTE**

*These requirements apply both to straight cable exit and right angle cable exit shielding.*



1. The back cover at the wire end of the receptacle butts against the locator tab in the inner shell.
2. The mating face of the receptacle is flush with the front of both shells.
3. The cable braid is spread evenly (without distortion to the weave) around the shield cable outlet, and the end of the cable jacket is against the end of the cable outlet.
4. The locking teeth of the inner shell and the locking windows of the outer shell are fully engaged.
5. There are no wires trapped between the shells.
6. For the step-down ferrule, the larger diameter end of the ferrule faces the terminated end of the cable. For the straight ferrule, either end can face the terminated end of the cable.



CABLE OUTSIDE DIAMETER RANGE	CONNECTOR SIZE (No. of Positions)	FERRULE CRIMP HEIGHT (a) +0.13/-0.25 [+0.005/-0.010] (b) +0.25/-0.13 [+0.010/-0.005]			
		STRAIGHT		STEP DOWN	
		Front (Braid)	Back (Insulation)=	Front (Braid)	Back (Insulation)=
4.32-4.95 [.170-.195]	6	—	—	6.86 [.270] (a)	4.70 [.185]
4.83-6.10 [.190-.240]	10, 16, 18	—	—	10.92 [.430] (a)	5.84 [.230]
5.08-6.35 [.200-.250]	6	—	—	6.86 [.270] (a)	5.49 [.216]
6.35-7.62 [.250-.300]	10, 16, 18	—	—	10.92 [.430] (a)	6.86 [.270]
7.87-9.14 [.310-.360]	10, 16, 18	—	—	10.92 [.430] (a)	8.64 [.340]
8.13-9.40 [.320-.370]	26, 40	—	—	11.58 [.456] (b)	8.64 [.340]
9.40-10.67 [.370-.420]	10, 16, 18	10.92 [.430] (a)	10.29 [.405]	—	—
	26, 40	—	—	11.58 [.456] (b)	10.11 [.398]
9.65-10.67 [.380-.420]	50	—	—	13.21 [.520] (b)	10.11 [.398]
	26, 40	11.58 [.456] (b)	11.18 [.440]	—	—
10.92-11.68 [.430-.460]	50	—	—	13.21 [.520] (b)	11.18 [.440]
	50	13.21 [.520] (b)	12.70 [.500]	—	—
11.94-13.21 [.470-.520]	60	—	—	15.88 [.625] (b)	12.70 [.500]
	60	—	—	15.88 [.625] (b)	13.46 [.530]
12.70-13.84 [.500-.545]	60	—	—	—	—
13.97-15.24 [.550-.600]	60	15.88 [.625] (b)	14.61 [.575]	—	—

▪ Dimension is typical. The crimp height for the back (insulation end) of the ferrule will vary according to cable material.

Figure 8

7. The crimped portion of the front of the ferrule is positioned over the cable braid and the shield cable outlet, and the crimped portion of the back of the ferrule is positioned over the cable jacket.

8. No cable braid strands are exposed.

9. Flash is the formation that may appear along the length on both sides of the ferrule as the result of the crimping process. The flash does not exceed the dimension provided in Figure 8.

10. There is no rear bellmouth. The front bellmouth is permissible, but must not exceed the dimension shown in Figure 8.

11. The ferrule crimp height is within the dimensions provided in Figure 8.



**NOTE**

The developed crimp configurations result from using the specific tooling described in Section 5.



**E. End-to-End Stacking**

Connectors can be stacked end-to-end within one pair of covers. Contact spacing on 2.54 × 2.54 mm [.100 × .100 in.] centerlines must be maintained.

**3.7. PC Board**

**A. Material and Thickness**

The pc board material shall be glass epoxy (FR-4 or G-10). The pc board must have a nominal thickness of 1.57 mm [.062 in.]. The maximum thickness of the pc board must be 1.83 mm [.072 in.].

**NOTE**

Contact the Product Information Center at the number listed at the bottom of page 1 for suitability of other board materials and thicknesses.



**B. Tolerance**

Maximum allowable bow of the pc board shall be 0.03 mm [.001 in.] over the length of the pin header.

**C. Hole Dimensions**

The holes in the pc board for the contact solder tines and, if applicable, the shield mounting posts must be drilled and plated through to specific dimensions. The plating type and thickness and finished hole size must be as stated to provide unrestricted insertion. See Figure 9.

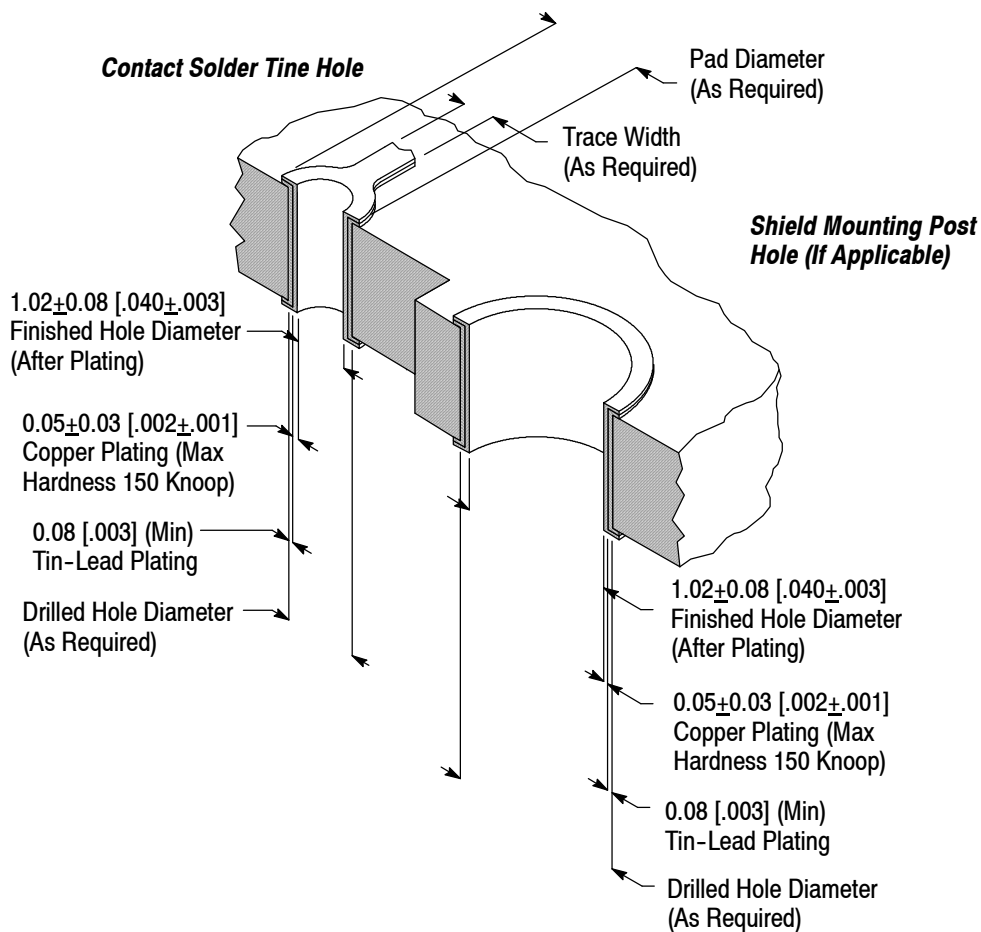


Figure 9

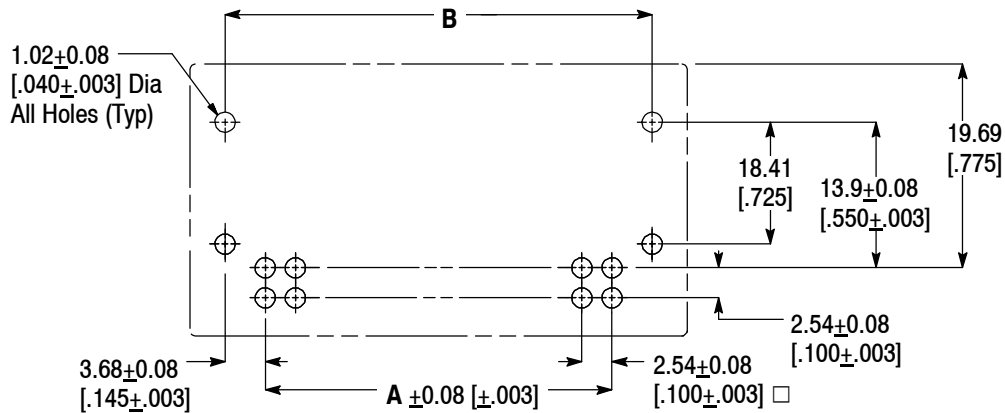
**D. Layout**

The pin header contact solder tine holes and, if applicable, shield mounting post holes in the pc board must be precisely located to ensure proper placement and optimum performance of the pin header. The pc board layout must be designed using the dimensions provided in Figure 10.

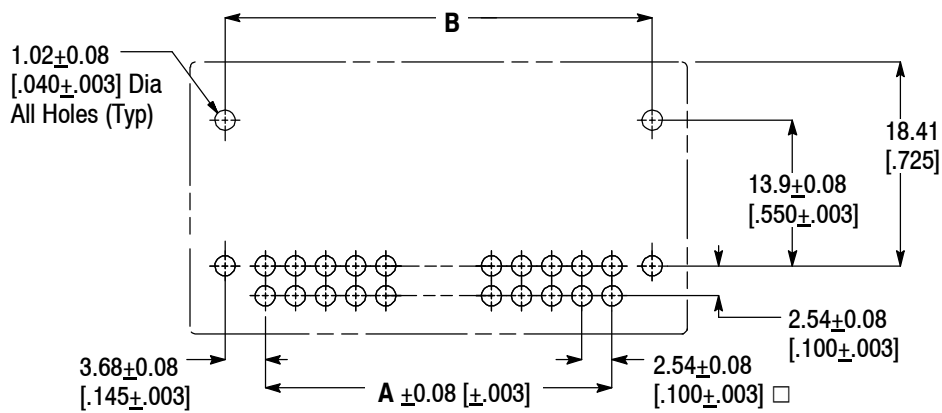
**Recommended PC Board Layout**

**Note:** Holes must not be included in layout for contacts removed for keying.

6, 8, and 10 Positions



16 Through 60 Positions



PIN HEADER SIZE (No. of Positions)	PC BOARD LAYOUT		
	SPACES AT 2.54±0.08 [.100±.003] BETWEEN HOLES	DIMENSION	
		A	B
6	2	5.08 [.200]	12.45 [.4900]
8	3	7.62 [.300]	14.99 [.590]
10	4	10.16 [.400]	17.53 [.690]
16	7	17.78 [.700]	25.15 [.990]
18	8	20.32 [.800]	27.69 [1.090]
20	9	22.86 [.900]	30.23 [1.190]
26	12	30.48 [1.200]	37.85 [1.490]
50	24	60.96 [2.400]	68.33 [2.690]

□ Tolerance is non-cumulative.

Figure 10

**3.8. Pin Header**

**A. Spacing**

Care must be used to avoid interference between adjacent connectors and other components. The minimum allowable distance between pin headers to ensure proper mating and unmating is provided in Figure 11.



*The information provided is for manual placement of pin headers. If robotic equipment is used, other space allowances will be required for the grippers.*

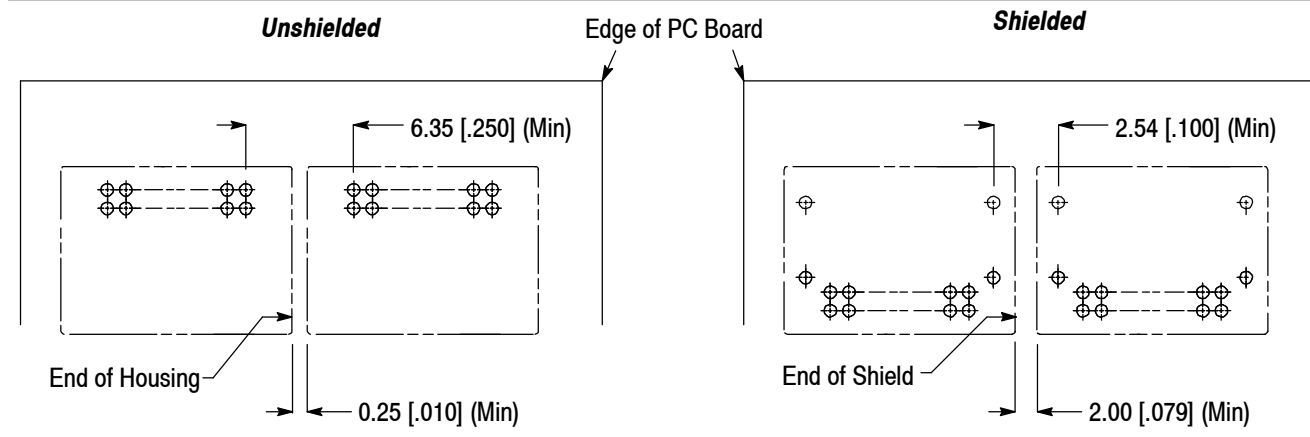


Figure 11

**B. Seating**



*Pin headers should be handled only by the housing to avoid deformation, contamination, or damage to the contact solder tines.*

The pin header number one position must be aligned with the number one position board hole. When placing the pin header on the pc board, the contact solder tines must align and start into the matching holes before seating the pin header onto the pc board. The pin header must be seated flush to the pc board and all contact solder tines must protrude through the board and be undamaged.

**C. Shielding**

Shielding for the pin header is a one-piece shell. The shielding must be installed according to the following. See Figure 12.

1. The shell cantilever beam must align with the mating face of the pin header.
2. The shell mounting posts must be fully inserted into the pc board mounting holes.
3. The shell must be fully seated on pc board.

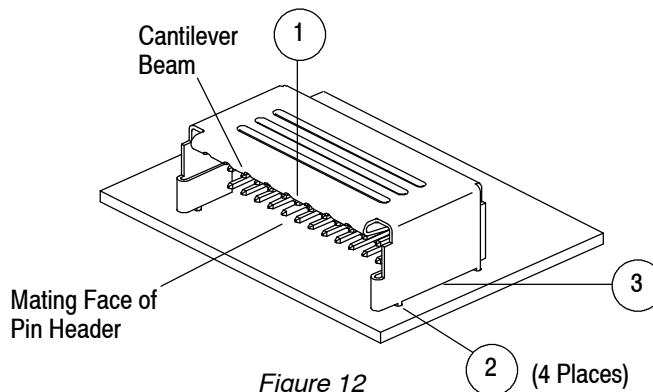


Figure 12

### 3.9. Soldering

#### A. Flux Selection

Contact solder tines and, if applicable, shield mounting posts must be fluxed prior to soldering with a mildly active rosin base flux. Selection of the flux will depend on the type of pc board and other components mounted on the board. Additionally, the flux must be compatible with the wave solder line, manufacturing, health, and safety requirements. Call Product Information at the number at the bottom of page 1 for consideration of other types of flux.

#### B. Process

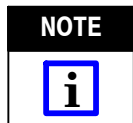
The pin headers can be soldered using wave soldering or equivalent soldering techniques. It is recommended using SN60 or SN62 solder for these pin headers. Refer to Manual 402-40 for soldering guidelines. The temperatures and exposure time shall be as specified in Figure 13.

SOLDERING PROCESS	TEMPERATURE	TIME (At Max Temp)
Wave	260°C [500°F]	5 Seconds

Figure 13

#### C. Cleaning

After soldering, removal of fluxes, residues, and activators is necessary. Consult with the supplier of the solder and flux for recommended cleaning solvents. Cleaners must be free of dissolved flux and other contaminants. It is recommended cleaning with the pc board on its edge. The following is a list of common cleaning solvents that will not the affect pin headers for the time and temperature specified. See Figure 14.



*If you have a particular solvent that is not listed, contact Product Information at the number at the bottom of page 1.*

CLEANER		TIME (Minutes)	TEMPERATURES (Maximum)	
NAME	TYPE		CELSIUS	FAHRENHEIT
ALPHA 2110	Aqueous	1	132	270
BIOACT EC-7	Solvent	5	100	212
Butyl CARBITOL	Solvent	1	Room Ambient	
Isopropyl Alcohol	Solvent	5	100	212
KESTER 5778	Aqueous	5	100	212
KESTER 5779	Aqueous	5	100	212
LONCOTERGE 520	Aqueous	5	100	212
LONCOTERGE 530	Aqueous	5	100	212
Terpene Solvent	Solvent	5	100	212

Figure 14



*Consideration must be given to toxicity and other safety requirements recommended by the solvent manufacturer. Refer to the manufacturer's Material Safety Data Sheet (MSDS) for characteristics and handling of cleaners. It is not recommended using Trichloroethylene and Methylene Chloride because of harmful occupational and environmental effects. Both are carcinogenic (cancer-causing).*

#### D. Drying

When drying cleaned assemblies and pc boards, make certain that temperature limitations are not exceeded: -65° to 105°C [-85° to 221°F]. Excessive temperatures may cause housing degradation.

### 3.10. Checking Installed Pin Header and Shield

All solder joints should conform to those specified in Workmanship Specification 101-2. The installed pin header must have solder fillets 360° around each contact solder tine and, if applicable, around each mounting post of the shield shell. The solder fillets must be evenly formed with no skips or voids. See Figure 15.

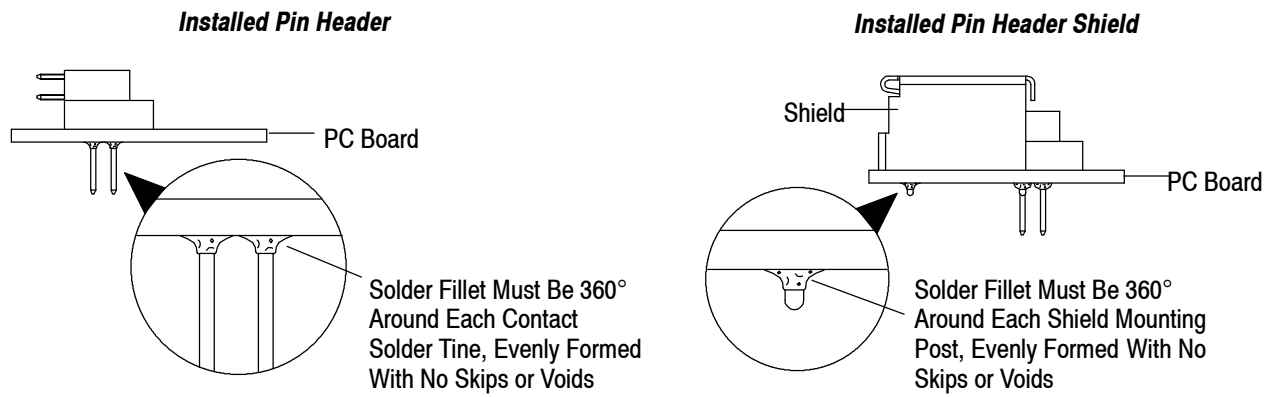
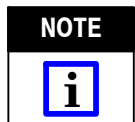


Figure 15

### 3.11. Keying

Further assurance of proper connector mating is provided by keying plugs. Keying plugs are used to selectively close contact cavities in receptacles. The receptacle keying plug position must be compatible with the pin header keying insert position (contact removed). The keying plugs can be inserted before or after receptacle termination. Refer to Figure 16.



*The contacts compatible with receptacle keying plug positions must be removed from the pin header before installation onto the pc board. These contacts cannot be re-used after removal.*

Keying plugs are available for empty contact cavities in receptacle housings where the keying plug is inserted into the contact cavity, and for pre-loaded receptacles where the keying plug is inserted into the contact (eliminating the need for contact removal from the receptacle). The locking lance of the keying plug must engage the housing. If properly inserted, there will be an audible “click.”

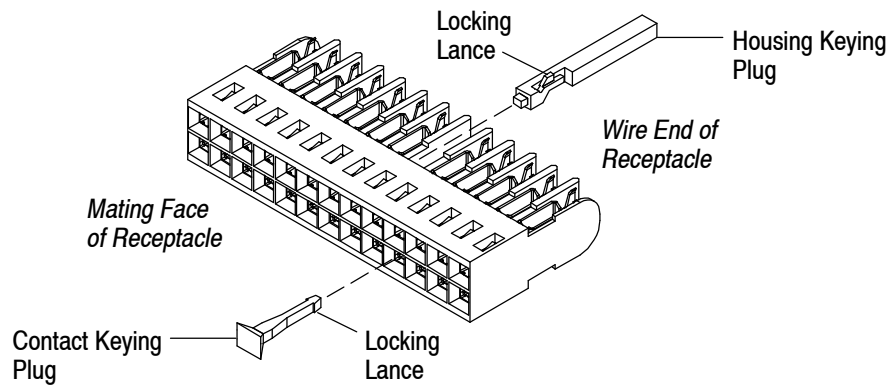


Figure 16

### 3.12. Mating and Unmating Connectors

The force required to mate connectors is provided in Figure 17.

#### A. Mating

Mated shielded connectors must conform to the following requirements. Refer to Figure 17.

1. The receptacle shield polarizing slots engage the pin header shield polarizing tabs.
2. The receptacle is fully bottomed in the pin header.

Mated unshielded connectors must conform to the following requirements. Refer to Figure 17.

1. Position 1 of the receptacle is matched with Position 1 of the pin header.
2. The receptacle must be fully bottomed on the pin header.

**B. Unmating**

The connectors must be unmated by rocking them apart. It is recommended that one end should be free, but should not be pulled more than 5° before rocking the same end back. This will release the opposite end, and the connectors will be separated. The force required to unmate connectors is provided in Figure 17.

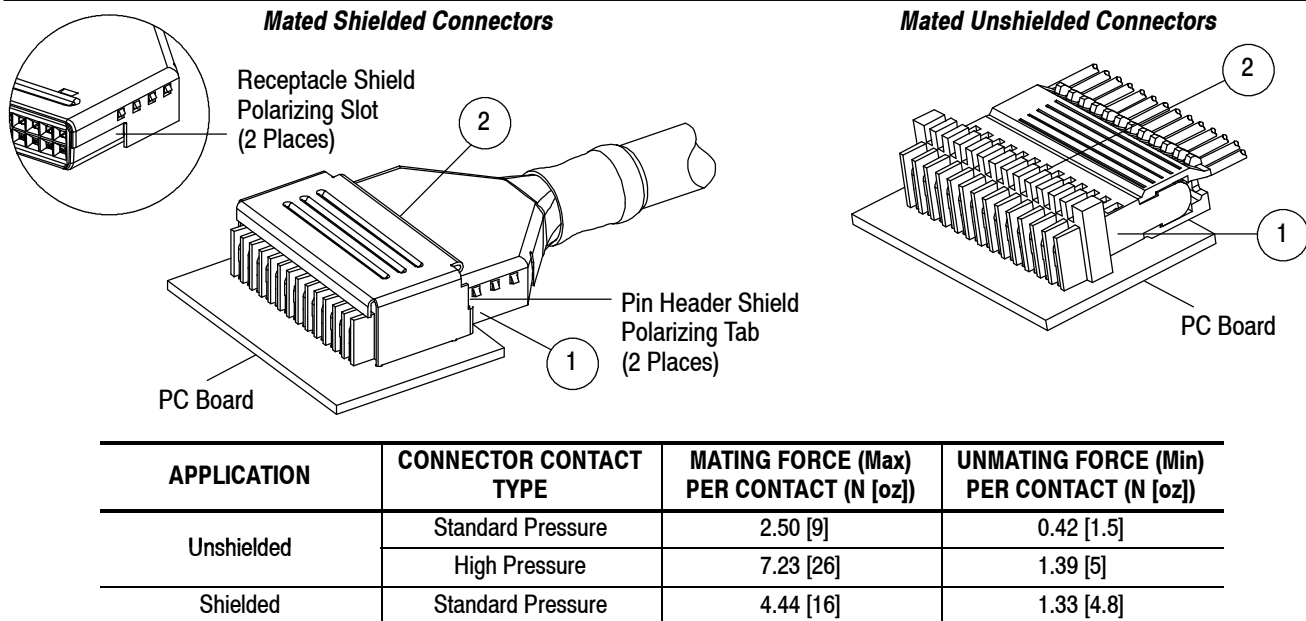


Figure 17

**3.13. Strain Relief and Wire Dress**

If required, discrete wires can be bundled together and supported with cable ties. Wires must not be stretched or confined in any way that would cause strain on the contacts. Therefore, the wires must remain perpendicular to the receptacle and avoid an excessively sharp bend radius. The minimum distance required before bending or forming wires, and the minimum distance required for location of the cable tie (measured from the wire end of the receptacle), is shown in Figure 18.

**CAUTION** Do not bend unsupported wires as this may cause strain on the contacts.

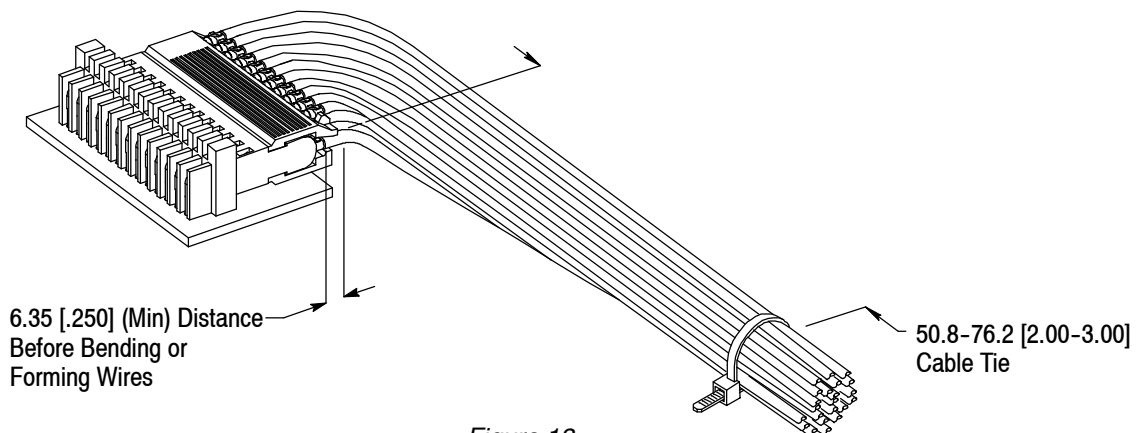


Figure 18

### 3.14. Repair

#### A. Connector

Damaged connectors must be discarded. Pin headers will require standard de-soldering of all contact solder tines for removal from the pc board.

#### NOTE



*Undamaged receptacle contacts can be removed from a damaged housing and re-used. Pin header contacts cannot be re-used.*

#### B. Contact

The contacts in the pin headers can be removed but are not replaceable. The contacts in receptacles are removable and replaceable. Damaged contacts must be discarded, however undamaged contacts can be re-used after removal from the receptacle. In this case, the contact locking lance must be reset before re-insertion into the receptacle.

#### CAUTION



*If a damaged contact is evident before the contact is inserted into the receptacle, the wire in back of the contact must be cut and re-terminated. If a contact is damaged after insertion, the contact must be removed from the receptacle using the appropriate tool, and the wire must be cut in back of the contact and re-terminated.*

#### C. Covers, Shielding, and Keying Plug

Pin header shields will require standard de-soldering of all mounting posts for removal from the pc board. Covers and shields cannot be re-used after removal from the connectors. Undamaged keying plugs can be re-used after removal from the connectors. Damaged keying plugs must be discarded.

## 4. QUALIFICATION

AMPMODU MT Interconnection Connectors are Listed by Underwriters Laboratories Inc. (UL) in File E28476, and Certified to CSA International in File LR 7189.

## 5. TOOLING

Tooling part numbers and instructional material packaged with the tooling are shown in Figure 19.

#### NOTE



*No tools are required to install receptacle covers, pin header shields, or keying plugs.*

### 5.1. Cable Preparation Tools

The ribbon cable cutting hand tool makes a perpendicular cut across ribbon cable. The ribbon cable notching tool separates individual wires of 2.54 mm [.100 in.] centerline ribbon cable to a specified length. The notching tool must be installed onto an arbor frame assembly, machine, or power unit. Tooling contained in adapter kits must be installed onto the notching tool to be used with the terminator machine or pneumatic power unit.

#### NOTE



*Commercial tools are available for slitting 1.27mm [.050 in.] centerline ribbon cable.*

### 5.2. Arbor Frames

The arbor frame assemblies provide the necessary force to drive tooling to be used for a specific purpose. The assemblies are available as manually-operated and actuated by a handle or pneumatically-powered and actuated by a foot switch. These assemblies are designed to be bench mounted and provide for low to medium volume production.

### 5.3. Terminating Tools

#### A. Hand Held Assemblies

The pistol grip handle assemblies provide the necessary force to drive a terminating head designed to terminate the receptacles. The terminating head must be installed onto the assembly. The assemblies are

available as manually-operated or pneumatically-powered, both actuated by a trigger. The pneumatic assembly is designed to allow the head to be rotated.

**NOTE**

*A hand tool package is available that consists of the manual handle assembly and terminating head.*

**B. Bench Mounted Assembly**

The power bench assembly provides the necessary force to drive a terminating head designed to terminate the receptacles. The terminating head must be installed onto the assembly. This assembly is pneumatically-powered and actuated by a foot switch. The assembly can be mounted according to operator preference and desired eject direction of the terminated receptacle.

**C. Hand Crimping Tool**

The hand crimping tool consists of a handle assembly with a head that accepts a specific die assembly. This tool has a ratchet that ensures full crimping pressure is applied to the ferrule used with the shielding for receptacles.

**5.4. Tooling****A. Adapter Kits**

These kits contain tooling that enables the ribbon cable notcher to be used with the terminating machine or pneumatic power unit.

**B. Die Assemblies**

These die assemblies feature crimping chambers designed to crimp the ferrule onto the cable braid and shield cable outlet. A die assembly must be installed onto the hand crimping tool or ferrule applicator assembly.

**C. Terminating Head**

This head terminates discrete wires onto the connectors using the insulation displacement technique. The head must be installed onto a handle assembly or power unit.

**NOTE**

*A hand tool package is available that consists of the terminating head and manual handle assembly.*

**D. Tooling Assembly and Tooling Kit**

The tooling assembly and tooling kit contain the necessary tooling to position the connector and wires for proper termination. The tooling assembly is used to mass terminate discrete wire, jacketed cable, or ribbon cable, and must be installed onto an arbor frame assembly. The tooling kit is used to terminate discrete wire and jacketed cable and must be installed onto a terminating machine.

**E. Upper Tool Mount and Discrete Wire Organizer Assembly**

This tooling must be installed onto the tooling assembly when used with the pneumatic applicator frame. The discrete wire organizer assembly must be installed onto the manual arbor frame assembly when terminating discrete wires.

**F. Ferrule Applicator Assembly**

This applicator assembly must be installed onto a power unit, and a specific die assembly must be installed onto the applicator assembly to crimp the ferrule used with the shielding for receptacles.

**5.5. Power Units****A. Electric Machine**

This electrically-powered machine provides the necessary action to power a terminating head to terminate receptacle onto discrete wire using the insulation displacement technique. The terminating head must be installed onto the machine. This machine is foot switch actuated and designed to be bench mounted.



**B. Pneumatic Machine**

This pneumatically-powered machine provides the necessary force to drive the ribbon cable notcher. An adapter kit must be installed onto the machine. The machine is foot switch or push button actuated and designed to be bench mounted. This machine provides for medium volume production.

**C. Semi-Automatic Machines**

CHAMPOMATOR 2.5 bench terminating machine is pneumatically- and electrically-powered, microprocessor-controlled unit that produces double-ended cable assemblies using the insulation displacement technique. This machine is used for discrete wire or jacketed cable, and a tooling kit must be installed onto the machine. This machine is designed to be bench mounted and provides for medium volume production.

The Model "K" terminating machine provides the necessary force to drive an applicator for crimping the ferrule used with the shielding for receptacles. The applicator must be installed onto the machine. These machines are designed to be bench mounted and provide for high volume production.

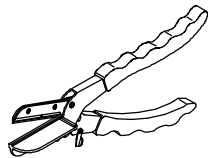
**5.6. Extraction Tool and Keying Tool**

The extraction/lance reset tool is used to remove contacts from the receptacle for repair or re-location. The tool is also used to reset depressed contact locking lances before re-inserting the contact into the receptacle. The keying tool is used to remove contacts from pin headers.

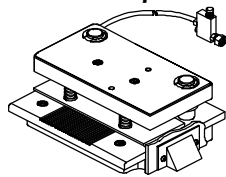
**5.7. PC Board Support**

For placement of pin headers onto the pc board, a pc board support must be used to prevent damage to the contact solder tines and shield mounting posts during placement. It should have flat surfaces with holes or a channel large enough and deep enough to receive the solder tines and, if applicable, the shield mounting posts.

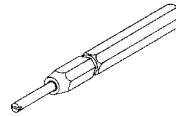
**Cable Preparation, Keying, and Extraction Tools**



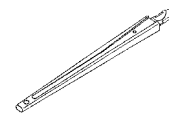
Ribbon Cable Cutting Hand Tool 91220-1 (408-6574)



Ribbon Cable Notcher 854449-[ ] (408-9515)

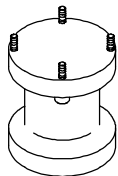


Keying Tool 843853-1 (408-9454)

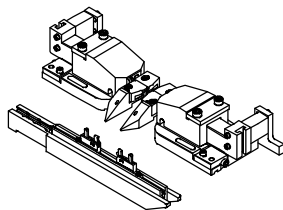


Extraction/Lance Reset Tool 843477-3 (408-9453)

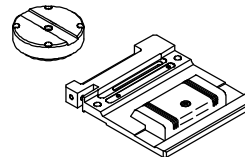
**Head, Adapter, Die Assembly, Applicator, and Board Support**



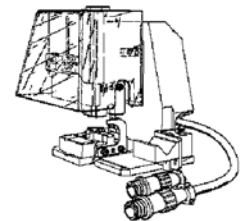
Adapter Kit 854468-[ ] (408-9687)



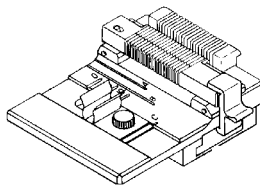
Tooling Kit 1-762661-0 (408-9678)



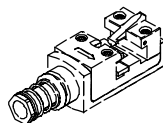
Pneumatic Upper Tool Mount 527145-1 and Discrete Wire Organizer Assembly 527085-1 (408-9138)



Ferrule Applicator Assembly 812407-1 (408-8083)



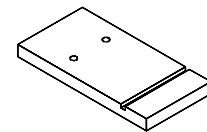
Tooling Assembly 91411-2 (408-9028)



Terminating Head 58062-1 (408-9085)



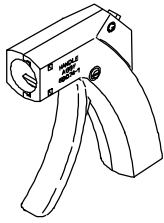
Die Assembly 812665-[ ] (No Document)  
Die Assembly 527116-[ ] (No Document)



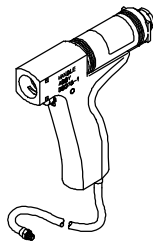
PC Board Support (Must Be Custom Made, Refer to 408-6927)

Figure 19 (cont'd)

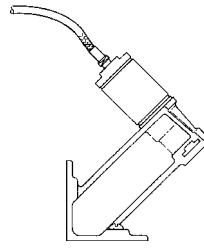
**Hand Tools, Arbor Frame Assemblies, Machines, and Power Units**



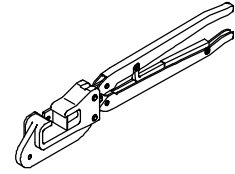
Pistol Grip Manual Handle Assembly 58074-1 (408-6790)



Pistol Grip Pneumatic Handle Assembly 58075-1 (408-6789)

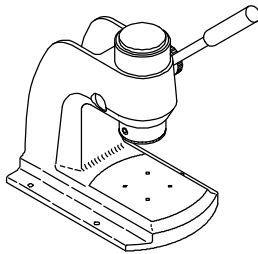


Pneumatic Power Bench Assembly 58338-1 (408-9393)

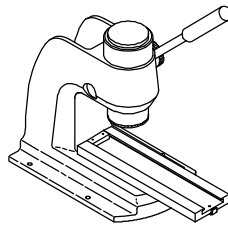


Hand Crimping Tool 91410-1 (408-6837)

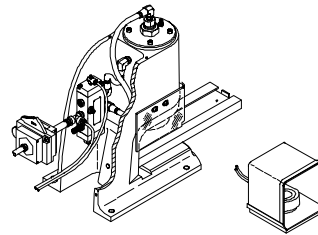
**Note:** Hand Tool Package 58577-1 consists of the pneumatic handle assembly and Terminating Head 58062-1.



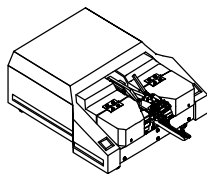
Manual Arbor Frame Assembly 58024-1 (408-6923)



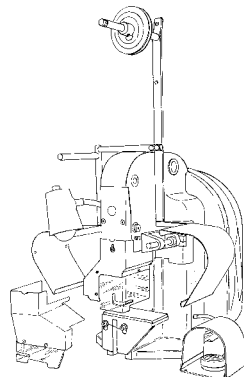
Manual Arbor Frame Assembly 91085-2 (408-7777)



Pneumatic Applicator Frame Assembly 91112-2 (408-7763)



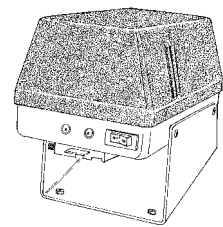
CHAMPOMATOR 2.5 Bench Terminating Machine 354786-1 (409-5839)



AMP-O-LECTRIC Model "K" Terminating Machine 2-565435-2 (or 565435-5) (409-5128)



2700-lb Pneumatic Power Unit 312522-1 (409-5843)



Electric Power Unit 931800-1 (409-5746)

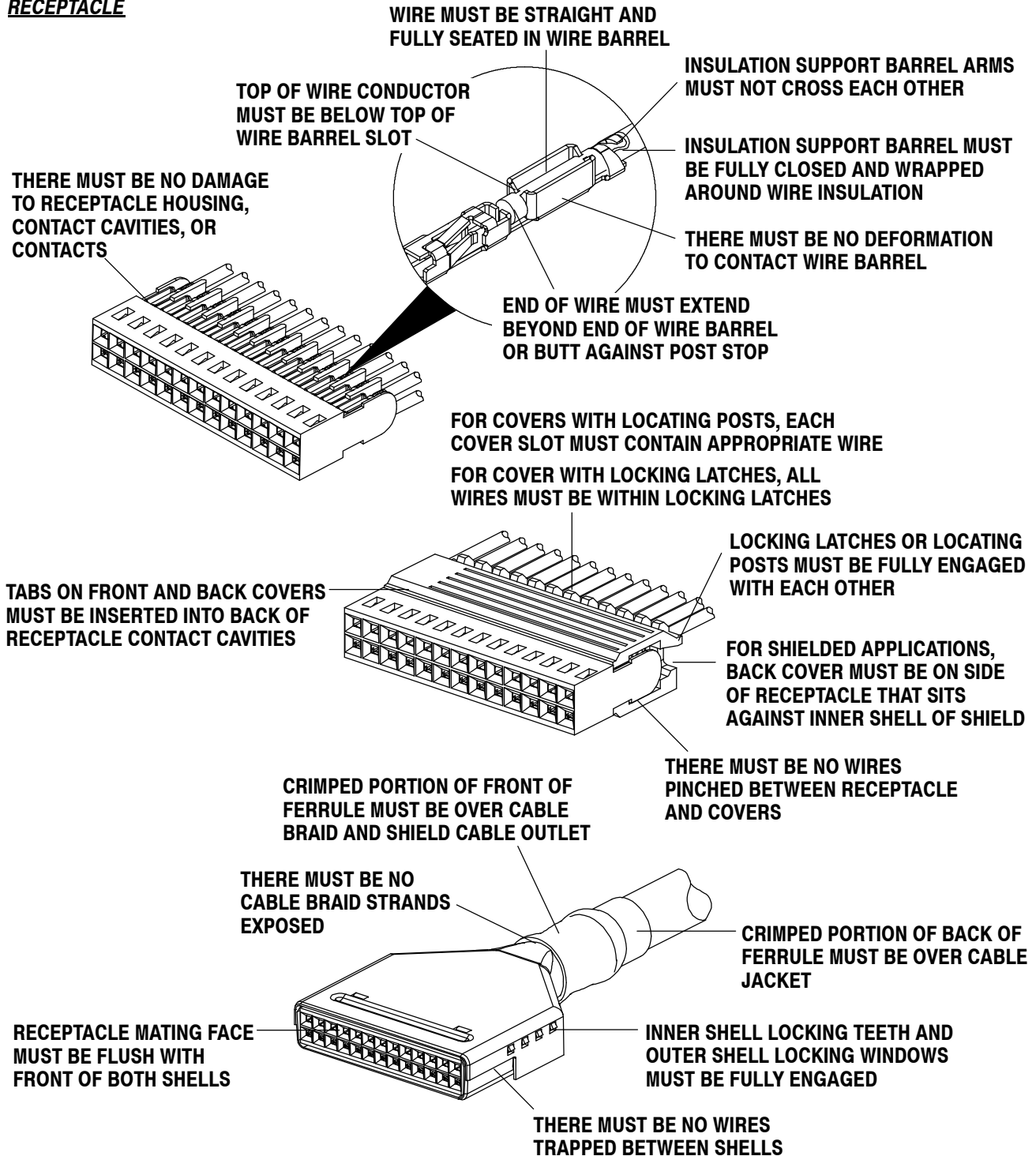
**Note:** Machine 565435-5 is no longer available for new applications, but can still be used for existing applications.

Figure 19 (end)

**6. VISUAL AID**

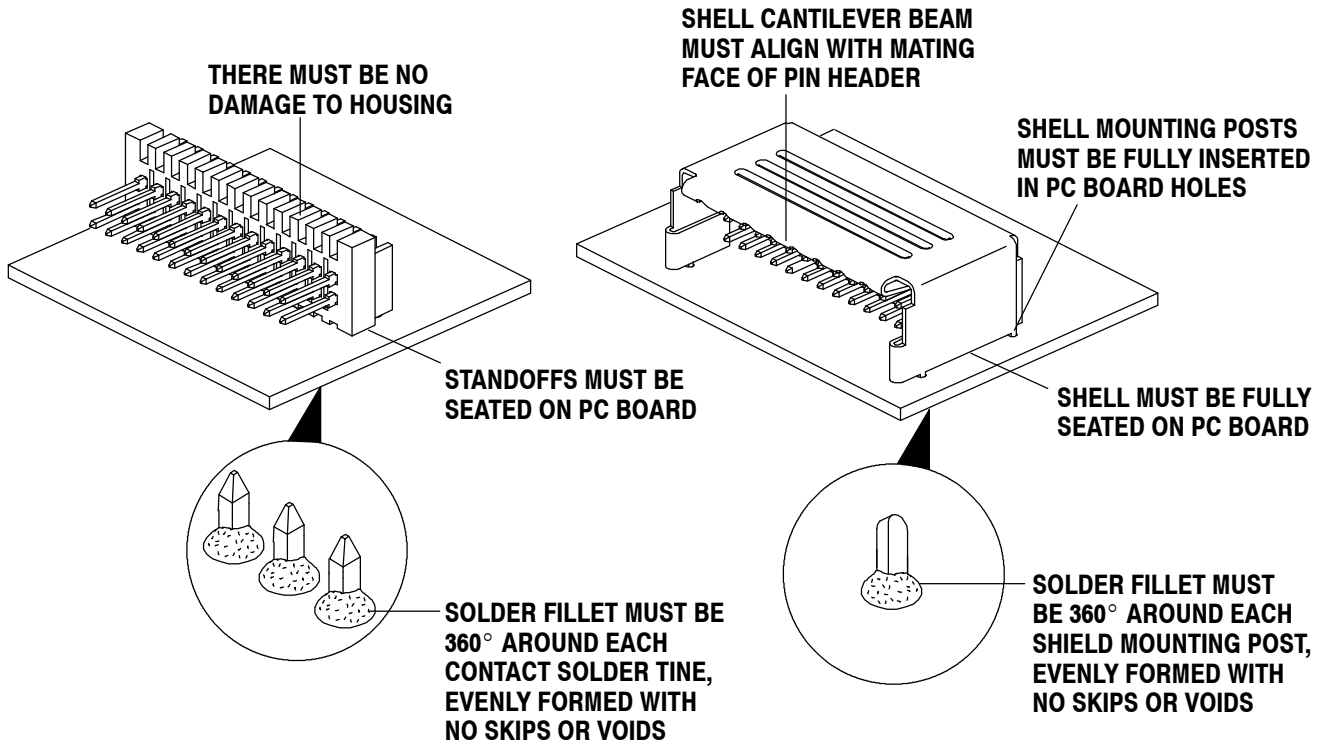
Figure 20 shows a typical application of AMPMODU MT Interconnection System. This illustration should be used by production personnel to ensure a correctly applied product. Applications which DO NOT appear correct should be inspected using the information in the preceding pages of this specification and in the instructional material shipped with the product or tooling.

**RECEPTACLE**

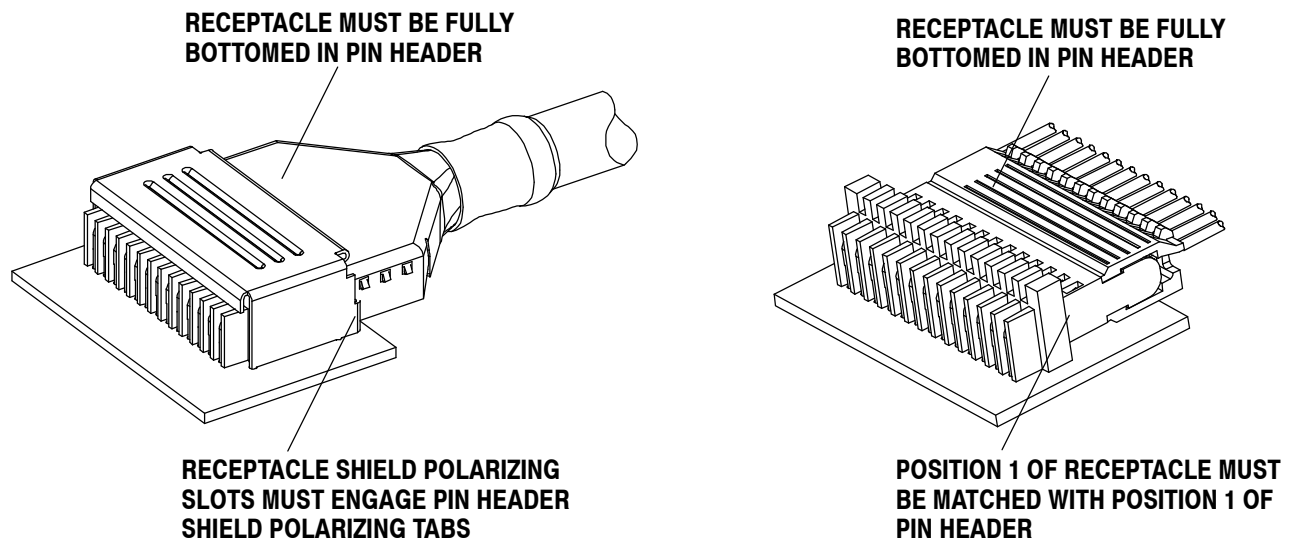


**FIGURE 20. VISUAL AID (CONT'D)**

**PIN HEADER**



**MATED CONNECTORS**



**FIGURE 20. VISUAL AID (END)**