

tyco

Electronics

AMP General Purpose Rectangular (GPR) Connectors



Table of Contents

Introduction3-4
 Performance Characteristics5
 GPRA1 Shell Descriptive Part Numbers and Dimensions6-7
 GPRB1 Shell Descriptive Part Numbers and Dimensions8-9
 GPRB2 Horizontal Shells10-12
 GPRB2 Vertical (Square) Shells13
 Insert Descriptive Part Numbers14-18
 Insert Arrangements19
 Insert Assemblies for High Speed Applications20-21
 Contacts & Application Tools22-23
 Spare Parts & Tools23
 EMI Backshells & Strain Reliefs24
 Gallery Insert (GAIN) Connectors25
 Custom Solutions & In Development Products26

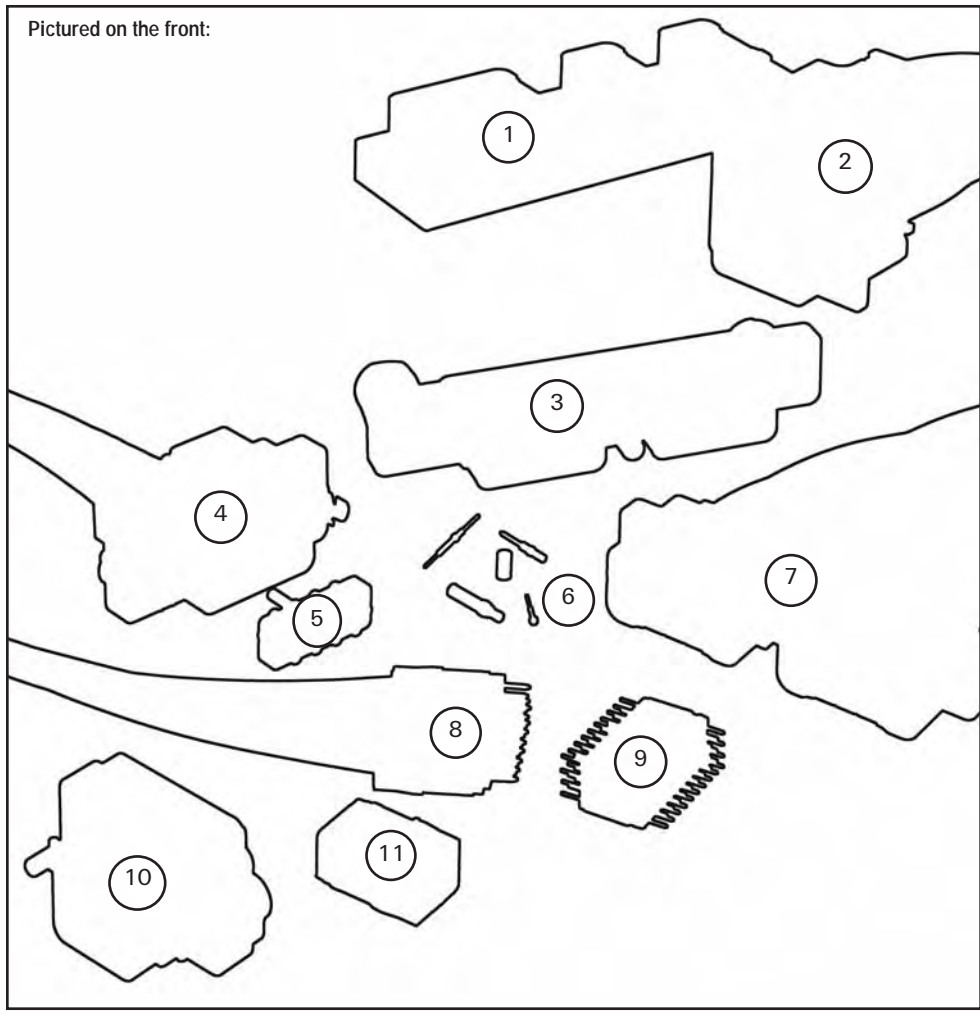

- 1 Custom 4-cavity receptacle shell
- 2 GPRB2 vertical shell & strain relief assembly
- 3 GPRB2 GAIN shell - with spring-loaded, float-mounting design
- 4 GPRB1 plug shell w/F12 LuxCis® insert and termini installed
- 5 F12 LuxCis® sleeve holder
- 6 Size 22 posted PC tail pin, Size 20 crimp pin, Size 5 Coax contacts
- 7 GPRB2 receptacle shell, with 30 & 40 position inserts installed
- 8 30 position insert with terminated Size 20 Pin contacts installed
- 9 Custom 40 position pin insert with PC tail contacts installed
- 10 GPRA plug shell assembly and 14M socket insert assembly
- 11 GPRA 14M pin insert assembly

© 2004, 2005 and 2006 by Tyco Electronics Corporation. All Rights Reserved
 AMP, PROBEAM and TYCO are trademarks.
 Skydrol is a trademark of Monsanto Company.
 Other products, logos, and company names mentioned herein may be trademarks of their respective owners.

LuxCis is a trademark of Radiall S.A. Product is manufactured under license from Radiall S.A.

Product manufactured under license from Radiall, S.A.

Introduction

Product Facts

- A high density solution compared to circular connectors
 - Slim shell design with high contact density
 - Stackable shells that do not require additional space for locking and unlocking the connectors
 - Uses two to three times less space
- A versatile solution suitable for disconnect panels or equipment with three mounting styles:
 - Rack
 - Cable to cable
 - Panel mounting
- A modular concept with a large variety of options
 - Shell can accommodate a wide variety of inserts for signal, power, coax, data bus and fiber optic contacts
 - Optional grounding blocks (to meet FAA HIRF requirements)
 - Pin and socket inserts can be mounted on either plug or receptacle shells
- A cost savings and user friendly solution
 - Inserts can be wired in the shop and later installed in the shells
 - A common panel cut out eases the connector installation and reduces cost
 - Inserts can be easily installed and removed from the shell
 - Inserts and shells are keyed to prevent mismatching
 - Standard MIL tools for contact crimping and contact insertion/extraction
 - Field replaceable sub assemblies
 - Vibration resistant self-locking threads

A Smart Connector

Tyco Electronics is recognized in the Aerospace and Defense industry for its global offering in interconnect solutions. The General Purpose Rectangular A & B Series connectors complement our ARINC connector line and provide additional flexibility with improved performance in a smaller mating area compared to standard circular MIL-Spec connectors.

The GPRA and GPRB series offer a wide range of solutions based on two insert sizes, a large variety of shells and contacts. The GPRA and GPRB series provides an excellent trade-off between the number of available contacts and the space actually used. GPRA inserts are a good option for low density applications whereas GPRB inserts offer twice the density of GPRA inserts. In addition, the concept is completely modular and expandable.

They can also be easily tailored for custom requirements, such as shell modifications for additional inserts.

New Features

Connector Interface

Connectors for Gallery Insert (GAIN) Equipment:

- Page 25 lists the GPRB2 shells, insert arrangements, contacts, seal plugs, strain reliefs and cable that will be used, per ARINC 810. This is the standard connector interface for new gallery equipment such as ovens and beverage makers for new commercial aircraft. This includes the twin-axial cable and contacts needed for the CANBUS data bus system used for GAIN.

Shells

GPRB1

- Shells have been improved to a greater level of performance under vibration. Also EMI performance has been maintained while eliminating the need for separate EMI springs.

GPRB2

- A new GPRB2 shell with mounting holes of 4.3 mm as been added (PN 1877335-1)
- A new 90° exit, low-profile metal backshell has been added (PN 1877338-1)
- Two vertical (square) shell configurations added, along with a strain relief (see page 12)

Insert Arrangements

- New insert configurations for high speed data transmission - both fiber and quadrax
- GPRB - Fiber Optics
 - F12 - holds up to 12 LuxCis® fiber optic termini (see page 20)
 - M2 - holds two 4-channel Mini-Expanded Beam inserts (see page 21)
- GPRB - Quadrax
 - Size 8 quadrax contacts can be used in three insert arrangements - 10Q2, 25Q1 and 3Q3
 - Quadrax contacts available for use are listed in our Quadrax catalog #1654012. These feature the exclusive Tyco Electronics one-piece dielectric that makes our quadrax contacts the easiest to install. If sealing is required with quadrax or twinax contacts, there is a size 8 seal boot assembly (PN 1877626-1) that is available. Use of this seal boot provides 50,000 foot altitude immersion protection as tested per Boeing Spec BPS-C-179.

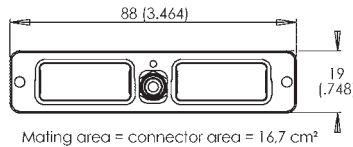

GPRB2 fitted with 80x size 22 contacts

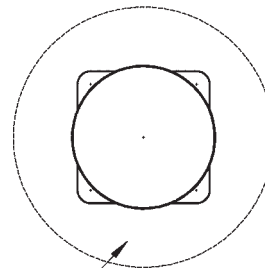

MIL-C-38999 21-35 fitted with 79x size 22 contacts

LuxCis is a trademark of Radiall S.A. Product is manufactured under license from Radiall S.A.

Introduction (Continued)

GPRA1

2 quarter-turn fasteners
 16 keying positions
 Max. density:
 20 x #22 contacts

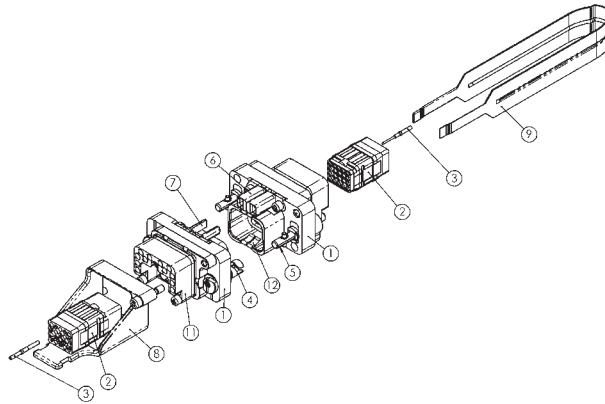

GPRB1

2 quarter-turn fasteners
 16 keying positions
 Max. density:
 40 x #22 contacts

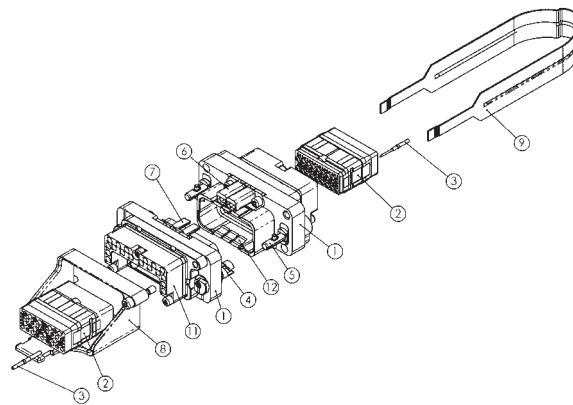

GPRB2

1 central jackscrew/jacknut
 12 keying positions
 Max. density:
 80 x #22 contacts

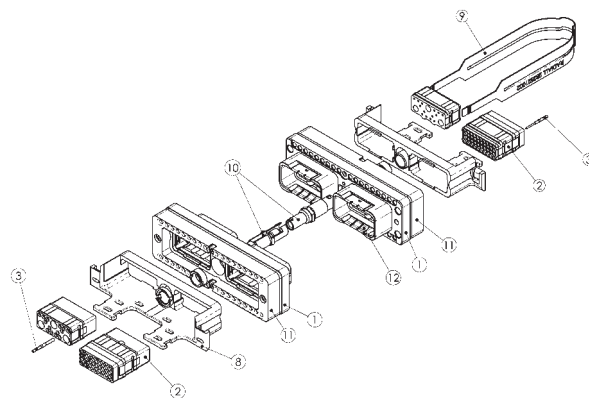

- | | |
|---------------------------|------------------------------------|
| ① shell | ⑧ backshell |
| ② insert | ⑨ insert insertion/extraction tool |
| ③ contact | ⑩ locking & polarization device |
| ④ & ⑤ locking device | ⑪ grounding block |
| ⑥ & ⑦ polarization device | ⑫ grounding springs |

Contacts

Electrical characteristics conform to MIL-C-39029 Type A

Electrical Characteristics

Grounding Block Contact

	Contact with Wire Size	Current Amps
Contact to Contact	Contact + 20 AWG	7.5
Contact to Mounting Surface	Contact + 20 AWG	7.5

Contacts

Contact Size	Wire Size	Current Amps
22	26 AWG	2
	24 AWG	3
	22 AWG	5
20	20 AWG	7.5
16	16 AWG	13
12	12 AWG	23
5	8 AWG	80 ¹

¹ Size 5 contacts are not part of MIL-C-39029 type A.

EMI Shielding Effectiveness

Frequency (MHz)	Leakage Attenuation (dB)
100	65
200	63
300	63
400	62
500	60
600	60

Mechanical Characteristics

Mating/Unmating Durability — 100 cycles

Mating Torque for GPRB2 Jackscrew — 1.2 Nm [11 in. lbs.]

Random Vibration —

GPRB1/GPRB1 — 20g (MIL-STD-1344/Method 2005.1, test condition 4)

GPRB2 — 41.7g (MIL-STD-1344/Method 2005.1, test condition 6)

Shock — 50g (MIL-STD-1344/Method 2004.1, test condition A)

Environmental Characteristics

Temperature Range — -65°C to +155°C [-85°F to +311°F]

Temperature Life — 1000 h @ 155°C [311°F]

Salt Spray — 96 hours (Nickel plating) (MIL-STD-1344/Method 1001.1, test condition A)

Humidity — 10 days

Altitude Immersion — 3 cycles at 15,240 m [50,000 ft.] (MIL-STD-1344/Method 1004.1)

Fluid Immersion — (MIL-STD-1344/Method 1016)

Dielectric Withstanding Voltage (MIL-STD-1344/Method 3001.1.1 with Leakage Current < 1 mΩ)

Level	Voltage (VRMS)
Sea level	1500
15,240 m [50,000 feet]	800

Insulation Resistance (MIL-STD-1344/Method 3003.1)

Ambient Temperature	> 5,000 MΩ
175°C [347°F]	> 200 MΩ

Other Characteristics

Shell to Shell Conductivity — < 2.5 mΩ

Operating Voltage — 400 Vrms or 500 Vdc at sea level

Voltage Stability (Ground Block) — Maximum variation 4mV (MIL-T-81714)

Magnetic Permeability — < 2

Comparative Tracking Index — 250 V

Contact Retention — (MIL-STD-1344/Method 2007.1 on terminated connectors)

Contact Size	Retention Force	Max. Displacement
Ground Block	88 N [20 lbs.]	0.3 mm [.012 in.]
22	53.4 N [12 lbs.]	0.38 mm [.015 in.]
20	89 N [20 lbs.]	0.38 mm [.015 in.]
16	111.2 N [25 lbs.]	0.38 mm [.015 in.]
12	133.45 N [30 lbs.]	0.38 mm [.015 in.]

Insert Retention — 500 N [112 lbs.] (MIL-STD-1344/Method 2010.1)

GPR A1 Shell Descriptive Part Number Format

Descriptive Part Numbering System

Use this guide to construct descriptive part numbers for GPR A1 shells. Refer to table below for the corresponding Tyco Electronics Part Number.

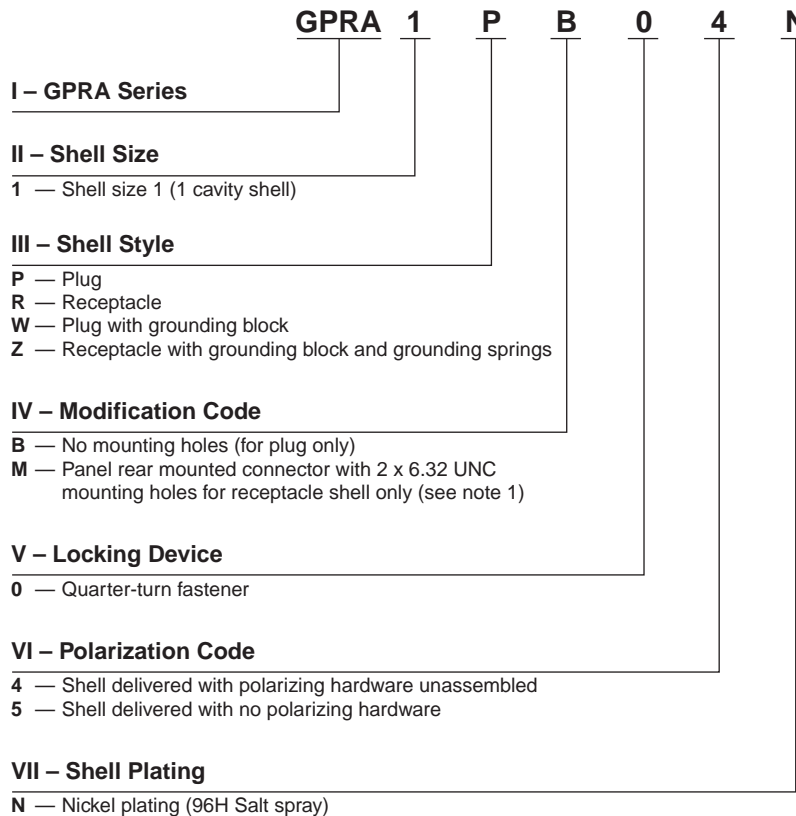

Note 1: Self-locking mounting holes are designed for rear panel mounting.

Size	Style	Modification	Locking Device	Polarization Hardware	Plating	Descriptive Part Number	Tyco Electronics Part Number
1	Plug	No mounting holes	1/4-Turn Fastener	Kit: Shell & Hardware Unassembled	Nickel	GPR A1PB04N	1738228-1
				No Hardware		GPR A1PB05N	1738229-1
	Plug, with Grounding Block	Rear Panel Mount, with two 6-32 UNC holes		Kit: Shell & Hardware Unassembled		GPR A1WB04N	1738230-1
				No Hardware		GPR A1WB05N	1738231-1
	Receptacle	Rear Panel Mount, with two 6-32 UNC holes		Kit: Shell & Hardware Unassembled		GPR A1RM04N	1738232-1
				No Hardware		GPR A1RM05N	1738233-1
Receptacle, with Grounding Block & Grounding Springs		Kit: Shell & Hardware Unassembled	GPR A1ZM04N	1738234-1			
		No Hardware	GPR A1ZM05N	1738235-1			

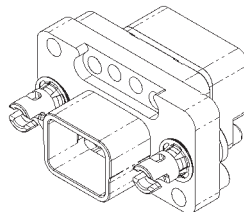

GPR A1WB05N

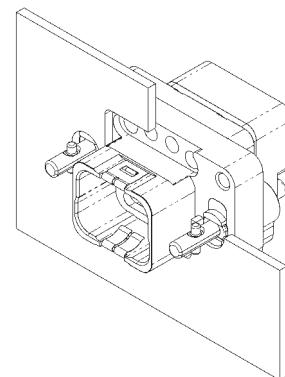

GPR A1ZM05N
Panel Rear Mounted Connector

GPRA1 Shell Dimensions

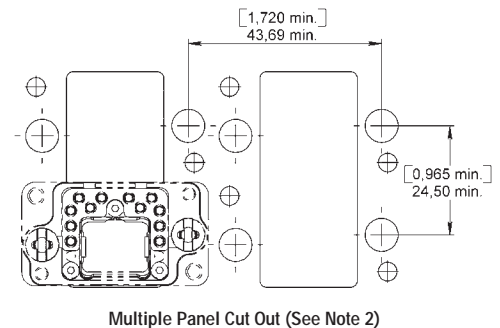
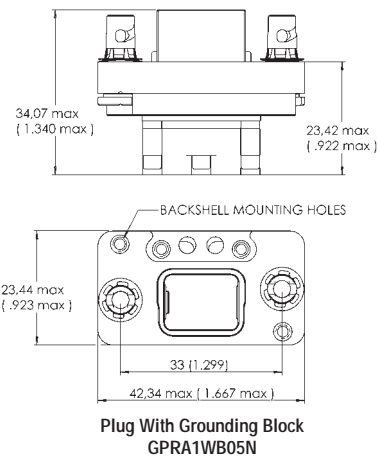
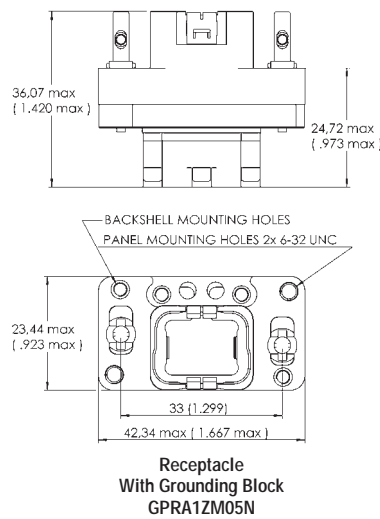
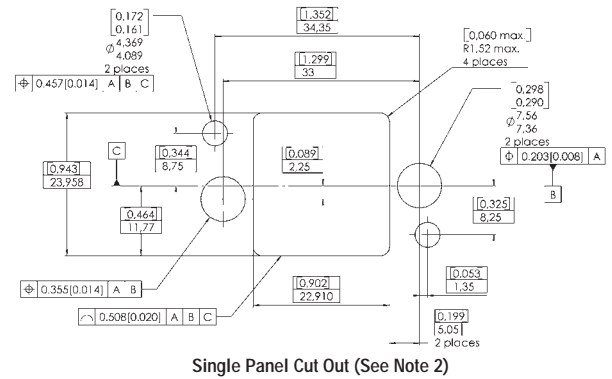
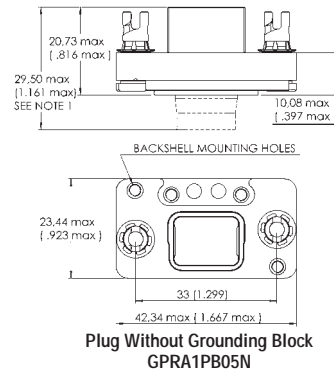
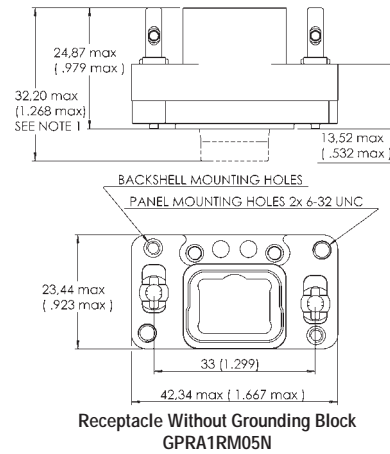

Note 1: Maximum dimension for inserts with grommets (Part Number GPRAE and GPRAH)
 Note 2: Rear mounting side view with key post oriented to the upper side (receptacle only)

GPRB1 Shell Descriptive Part Number Format

Descriptive Part Numbering System

Use this guide to construct descriptive part numbers for GPRB1 shells. Refer to table below for the corresponding Tyco Electronics Part Number.

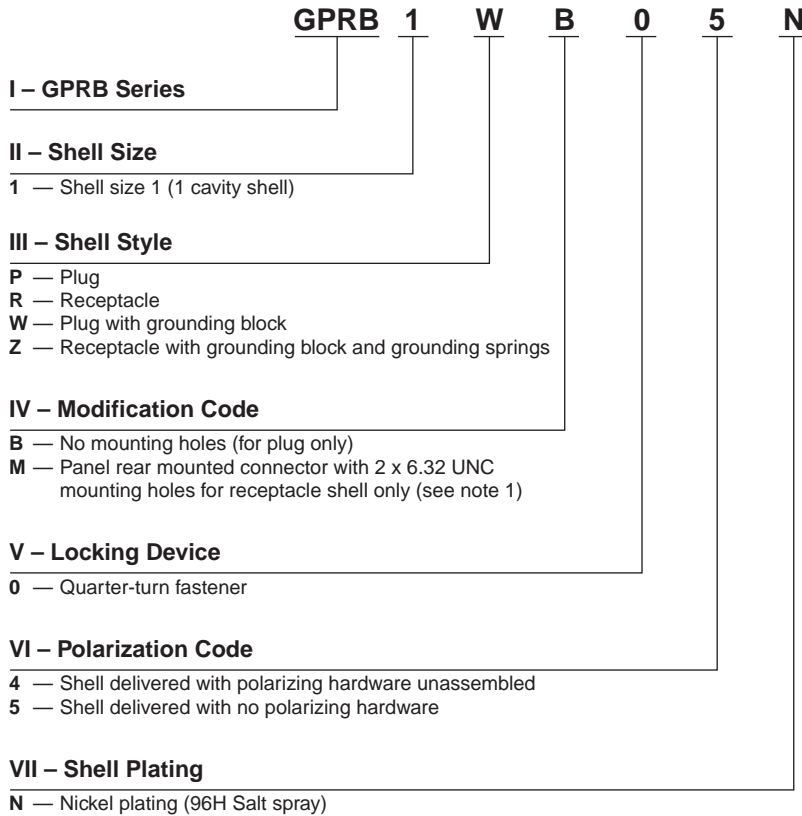

Note 1: Self-locking mounting holes are designed for rear panel mounting.

Size	Style	Modification	Locking Device	Polarization Hardware	Plating	Descriptive Part Number	Tyco Electronics Part Number
1	Plug	No mounting holes	1/4-Turn Fastener	Kit: Shell & Hardware Unassembled	Nickel	GPRB1PB04N	1738236-1
				No Hardware		GPRB1PB05N	1738237-1
	Kit: Shell & Hardware Unassembled			GPRB1WB04N		1738238-1	
	No Hardware			GPRB1WB05N		1738239-1	
	Receptacle	Rear Panel Mount, with two 6-32 UNC holes		Kit: Shell & Hardware Unassembled		GPRB1RM04N	1738240-1
				No Hardware		GPRB1RM05N	1738241-1
	Kit: Shell & Hardware Unassembled			GPRB1ZM04N		1738242-1	
	No Hardware			GPRB1ZM05N		1738243-1	

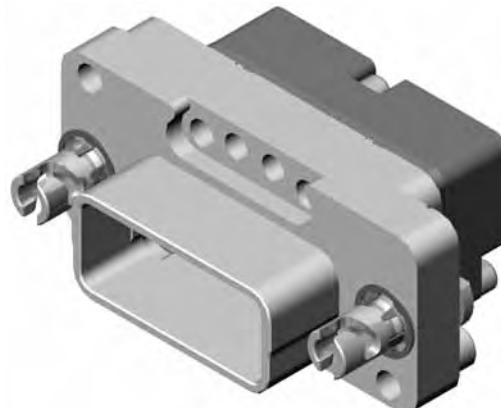

GPRB1WB05N

GPRB1 Shell Dimensions

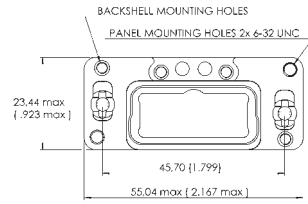
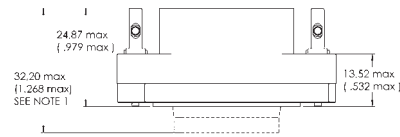

**Receptacle Without Grounding Block
GPRB1RM05N**

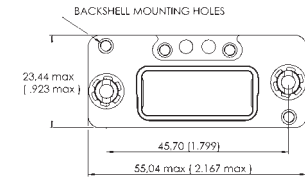
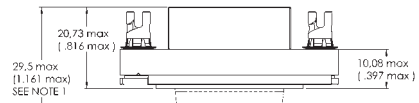

**Plug Without Grounding Block
GPRB1PB05N**

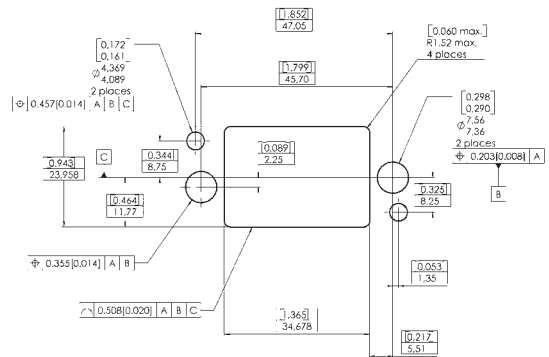

**Single Panel Cut Out
(See Note 2)**

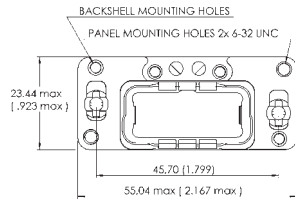
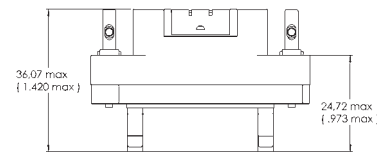

**Receptacle With Grounding Block
GPRB1ZM05N**

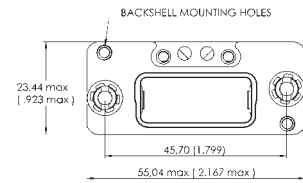
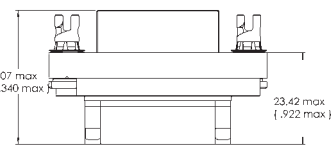

**Plug With Grounding Block
GPRB1WB05N**

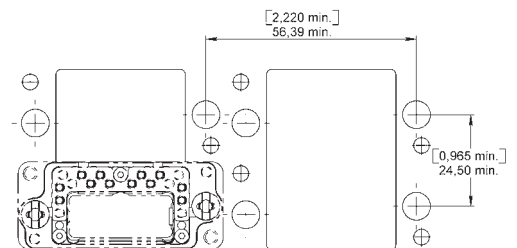

**Multiple Panel Cut Out
(See Note 2)**

Note 1: Maximum dimension for inserts with grommets (Part Number GPRBE and GPRBH)
 Note 2: Rear mounting side view with key post oriented to the upper side (receptacle only)
 Note 3: Only insert with keying A can be used with GPRB1 shells

GPRB2 (Horizontal) Shell Descriptive Part Number Format

Descriptive Part Numbering System

Use this guide to construct descriptive part numbers for GPRB2 shells. Refer to page 11 for the corresponding Tyco Electronics Part Number.

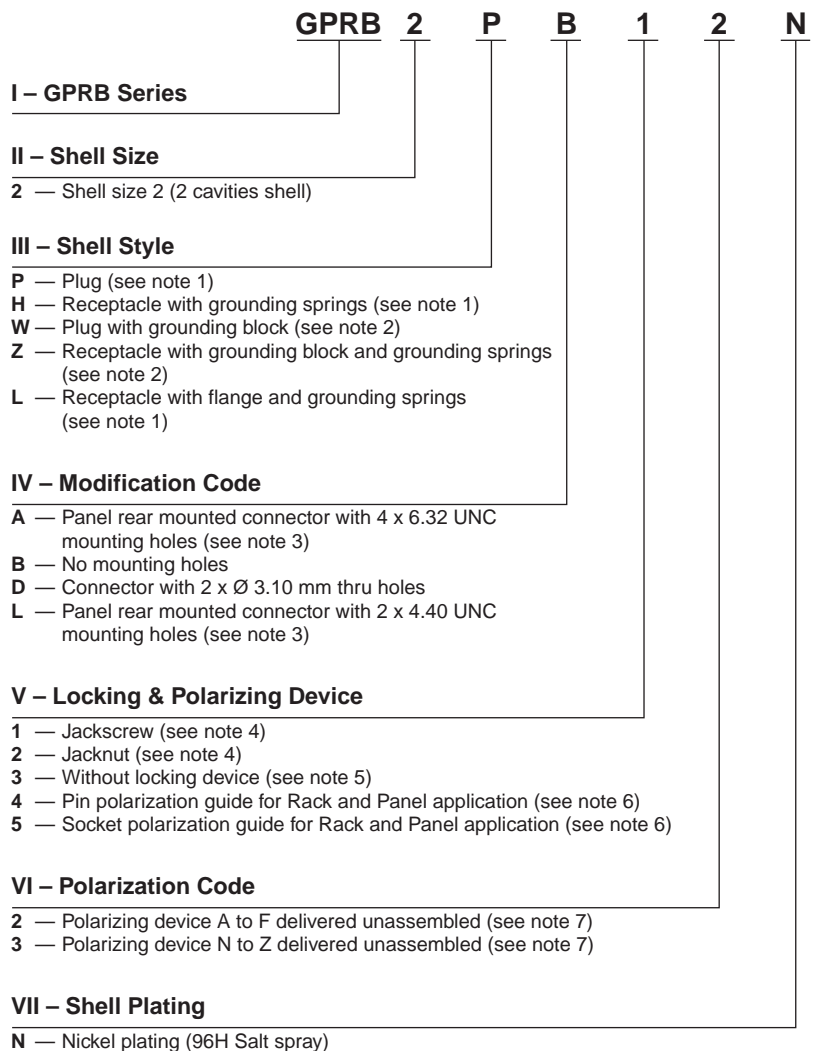

- Notes: 1. The standard modification codes for these shells are B, D or L.
 2. With modification codes A or B only.
 3. Self-locking mounting holes are designed for rear panel mounting.
 4. Jackscrew/Jacknut can be mounted on either plug or receptacle shell. However, the standard options are:
 —Jackscrew for plug shells
 —Jacknut for receptacle shells
 5. Option 3 in paragraph V cancels the polarization code paragraph IV, i.e. the shell is delivered with no polarizing device.
 6. Pin/Socket polarization guides can be mounted on either plug or receptacle shells. However, the standard options are:
 —Pin polarization guide for plug shells
 —Socket polarization guide for receptacle shells
 7. Polarizing device is delivered unassembled, it must be locked with resin by the user (LOCTITE™ 272 must be used).
 —if no polarizing device is required, omit this step and go to VII.

GPRB2 (Horizontal) Shell Descriptive Part Number Format (Continued)

Size	Style	Modification	Locking & Polarization Device	Polarization Hardware	Plating	Descriptive Part Number	Tyco Electronics Part Number
2	Plug	No mounting holes	N/A	N/A	Nickel	GPRB2PB3N	1738244-1
			Jackscrew	Kit: Shell & A-F Hardware Unassembled Kit: Shell & N-Z Hardware Unassembled		GPRB2PB12N	1738245-1
			Pin Polarization Guide	Kit: Shell & A-F Hardware Unassembled Kit: Shell & N-Z Hardware Unassembled		GPRB2PB13N	1738246-1
			Pin Polarization Guide	Kit: Shell & A-F Hardware Unassembled Kit: Shell & N-Z Hardware Unassembled		GPRB2PB42N	1738247-1
			Pin Polarization Guide	Kit: Shell & A-F Hardware Unassembled Kit: Shell & N-Z Hardware Unassembled		GPRB2PB43N	1738248-1
			N/A	N/A		GPRB2PD3N	1738249-1
		Connector with two thru-holes [3.10mm Dia.]	N/A	N/A		GPRB2PD12N	1738250-1
			Jackscrew	Kit: Shell & A-F Hardware Unassembled Kit: Shell & N-Z Hardware Unassembled		GPRB2PD13N	1738251-1
			Pin Polarization Guide	Kit: Shell & A-F Hardware Unassembled Kit: Shell & N-Z Hardware Unassembled		GPRB2PD42N	1738252-1
			Pin Polarization Guide	Kit: Shell & A-F Hardware Unassembled Kit: Shell & N-Z Hardware Unassembled		GPRB2PD43N	1738253-1
			N/A	N/A		GPRB2PL3N	1738254-1
			Jackscrew	Kit: Shell & A-F Hardware Unassembled Kit: Shell & N-Z Hardware Unassembled		GPRB2PL12N	1738255-1
	Rear Panel Mount, with two 4-40 UNC holes	Pin Polarization Guide	Kit: Shell & A-F Hardware Unassembled Kit: Shell & N-Z Hardware Unassembled	GPRB2PL13N	1738256-1		
		Pin Polarization Guide	Kit: Shell & A-F Hardware Unassembled Kit: Shell & N-Z Hardware Unassembled	GPRB2PL42N	1738257-1		
		Pin Polarization Guide	Kit: Shell & A-F Hardware Unassembled Kit: Shell & N-Z Hardware Unassembled	GPRB2PL43N	1738258-1		
		N/A	N/A	GPRB2WB3N	1738259-1		
		Jackscrew	Kit: Shell & A-F Hardware Unassembled Kit: Shell & N-Z Hardware Unassembled	GPRB2WB12N	1738260-1		
		Pin Polarization Guide	Kit: Shell & A-F Hardware Unassembled Kit: Shell & N-Z Hardware Unassembled	GPRB2WB13N	1738261-1		
	Plug, with Grounding Block	No mounting holes	Pin Polarization Guide	Kit: Shell & A-F Hardware Unassembled Kit: Shell & N-Z Hardware Unassembled	GPRB2WB42N	1738262-1	
			Pin Polarization Guide	Kit: Shell & A-F Hardware Unassembled Kit: Shell & N-Z Hardware Unassembled	GPRB2WB43N	1738263-1	
			N/A	N/A	GPRB2WA3N	1738264-1	
			Jackscrew	Kit: Shell & A-F Hardware Unassembled Kit: Shell & N-Z Hardware Unassembled	GPRB2WA12N	1738265-1	
			Pin Polarization Guide	Kit: Shell & A-F Hardware Unassembled Kit: Shell & N-Z Hardware Unassembled	GPRB2WA13N	1738266-1	
			Pin Polarization Guide	Kit: Shell & A-F Hardware Unassembled Kit: Shell & N-Z Hardware Unassembled	GPRB2WA42N	1738267-1	
Rear Panel Mount, with four 6-32 UNC holes		Pin Polarization Guide	Kit: Shell & A-F Hardware Unassembled Kit: Shell & N-Z Hardware Unassembled	GPRB2WA43N	1738268-1		
		N/A	N/A	GPRB2HB3N	1738269-1		
		No mounting holes	Jacknut	Kit: Shell & A-F Hardware Unassembled Kit: Shell & N-Z Hardware Unassembled	GPRB2HB22N	1738270-1	
			Jacknut	Kit: Shell & A-F Hardware Unassembled Kit: Shell & N-Z Hardware Unassembled	GPRB2HB23N	1738271-1	
			Socket Polarization Guide	Kit: Shell & A-F Hardware Unassembled Kit: Shell & N-Z Hardware Unassembled	GPRB2HB52N	1738272-1	
			Socket Polarization Guide	Kit: Shell & A-F Hardware Unassembled Kit: Shell & N-Z Hardware Unassembled	GPRB2HB53N	1738273-1	
N/A	N/A		GPRB2HD3N	1738274-1			
Jacknut	Kit: Shell & A-F Hardware Unassembled Kit: Shell & N-Z Hardware Unassembled		GPRB2HD22N	1738275-1			
Receptacle, with Grounding Springs	Connector with two thru-holes [3.10mm Dia.]	Socket Polarization Guide	Kit: Shell & A-F Hardware Unassembled Kit: Shell & N-Z Hardware Unassembled	GPRB2HD23N	1738276-1		
		Socket Polarization Guide	Kit: Shell & A-F Hardware Unassembled Kit: Shell & N-Z Hardware Unassembled	GPRB2HD52N	1738277-1		
		Socket Polarization Guide	Kit: Shell & A-F Hardware Unassembled Kit: Shell & N-Z Hardware Unassembled	GPRB2HD53N	1738278-1		
		[4.3mm Dia.]	Kit: Shell & N-Z Hardware Unassembled	—	1877335-1		
		N/A	N/A	GPRB2HL3N	1738279-1		
		Jacknut	Kit: Shell & A-F Hardware Unassembled Kit: Shell & N-Z Hardware Unassembled	GPRB2HL22N	1738280-1		
	Rear Panel Mount, with two 4-40 UNC holes	Socket Polarization Guide	Kit: Shell & A-F Hardware Unassembled Kit: Shell & N-Z Hardware Unassembled	GPRB2HL23N	1738281-1		
		Socket Polarization Guide	Kit: Shell & A-F Hardware Unassembled Kit: Shell & N-Z Hardware Unassembled	GPRB2HL52N	1738282-1		
		Socket Polarization Guide	Kit: Shell & A-F Hardware Unassembled Kit: Shell & N-Z Hardware Unassembled	GPRB2HL53N	1738283-1		
		N/A	N/A	GPRB2LB3N	1738284-1		
		No mounting holes	Jacknut	Kit: Shell & A-F Hardware Unassembled Kit: Shell & N-Z Hardware Unassembled	GPRB2LB22N	1738285-1	
			Jacknut	Kit: Shell & A-F Hardware Unassembled Kit: Shell & N-Z Hardware Unassembled	GPRB2LB23N	1738286-1	
Socket Polarization Guide	Kit: Shell & A-F Hardware Unassembled Kit: Shell & N-Z Hardware Unassembled		GPRB2LB52N	1738287-1			
Socket Polarization Guide	Kit: Shell & A-F Hardware Unassembled Kit: Shell & N-Z Hardware Unassembled		GPRB2LB53N	1738288-1			
N/A	N/A		GPRB2LD3N	1738289-1			
Jacknut	Kit: Shell & A-F Hardware Unassembled Kit: Shell & N-Z Hardware Unassembled		GPRB2LD22N	1738290-1			
Receptacle, with Flange & Grounding Springs	Connector with two thru-holes [3.10mm Dia.]	Socket Polarization Guide	Kit: Shell & A-F Hardware Unassembled Kit: Shell & N-Z Hardware Unassembled	GPRB2LD23N	1738291-1		
		Socket Polarization Guide	Kit: Shell & A-F Hardware Unassembled Kit: Shell & N-Z Hardware Unassembled	GPRB2LD52N	1738292-1		
		Socket Polarization Guide	Kit: Shell & A-F Hardware Unassembled Kit: Shell & N-Z Hardware Unassembled	GPRB2LD53N	1738293-1		
		N/A	N/A	GPRB2LL3N	1738294-1		
		Rear Panel Mount, with two 4-40 UNC holes	Jacknut	Kit: Shell & A-F Hardware Unassembled Kit: Shell & N-Z Hardware Unassembled	GPRB2LL22N	1738295-1	
			Jacknut	Kit: Shell & A-F Hardware Unassembled Kit: Shell & N-Z Hardware Unassembled	GPRB2LL23N	1738296-1	
	Socket Polarization Guide		Kit: Shell & A-F Hardware Unassembled Kit: Shell & N-Z Hardware Unassembled	GPRB2LL52N	1738297-1		
	Socket Polarization Guide		Kit: Shell & A-F Hardware Unassembled Kit: Shell & N-Z Hardware Unassembled	GPRB2LL53N	1738298-1		
	N/A		N/A	GPRB2ZB3N	1738299-1		
	Jacknut		Kit: Shell & A-F Hardware Unassembled Kit: Shell & N-Z Hardware Unassembled	GPRB2ZB22N	1738300-1		
	Receptacle, with Grounding Block & Grounding Springs	No mounting holes	Jacknut	Kit: Shell & A-F Hardware Unassembled Kit: Shell & N-Z Hardware Unassembled	GPRB2ZB23N	1738301-1	
			Socket Polarization Guide	Kit: Shell & A-F Hardware Unassembled Kit: Shell & N-Z Hardware Unassembled	GPRB2ZB52N	1738302-1	
Socket Polarization Guide			Kit: Shell & A-F Hardware Unassembled Kit: Shell & N-Z Hardware Unassembled	GPRB2ZB53N	1738303-1		
N/A			N/A	GPRB2ZA3N	1738304-1		
Rear Panel Mount, with four 6-32 UNC holes			Jacknut	Kit: Shell & A-F Hardware Unassembled Kit: Shell & N-Z Hardware Unassembled	GPRB2ZA22N	1738305-1	
			Jacknut	Kit: Shell & A-F Hardware Unassembled Kit: Shell & N-Z Hardware Unassembled	GPRB2ZA23N	1738306-1	
		Socket Polarization Guide	Kit: Shell & A-F Hardware Unassembled Kit: Shell & N-Z Hardware Unassembled	GPRB2ZA52N	1738307-1		
		Socket Polarization Guide	Kit: Shell & A-F Hardware Unassembled Kit: Shell & N-Z Hardware Unassembled	GPRB2ZA53N	1738308-1		

GPRB2 (Horizontal) Shell Dimensions

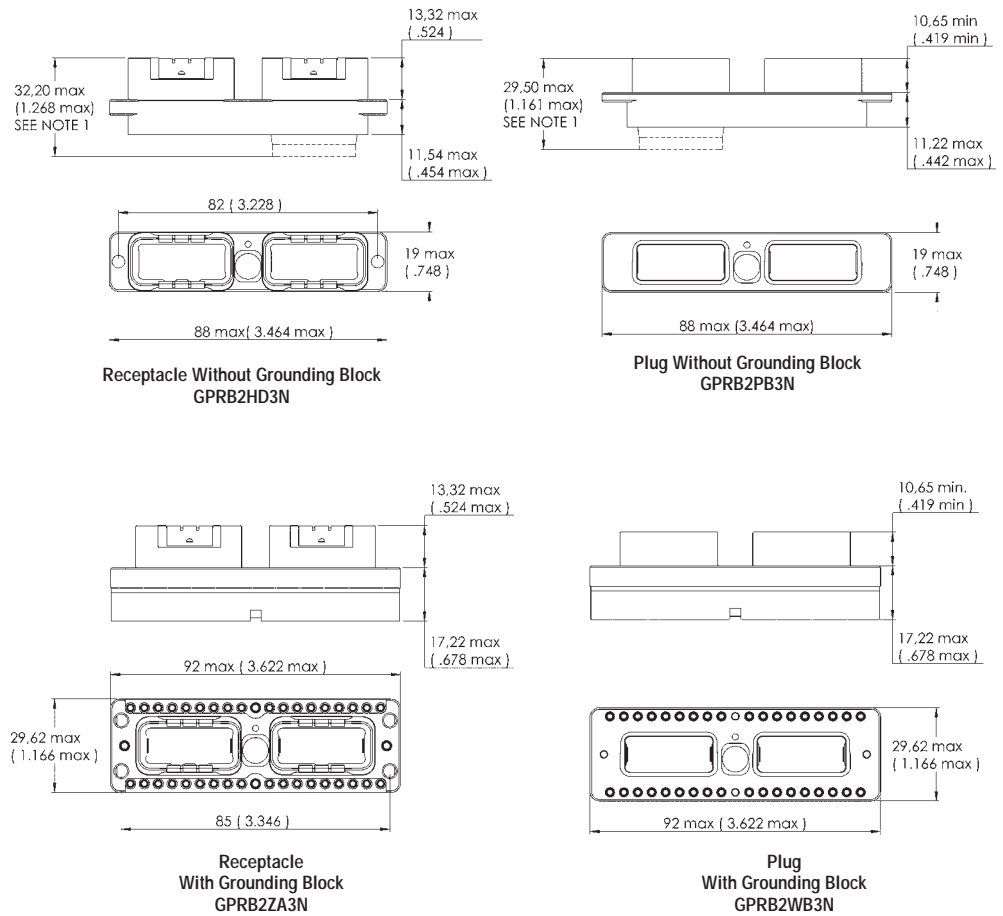

Grounding Block

A solution for High Intensity Radiated Electromagnetic Frequencies. The patented design provides a direct grounding to the shell.

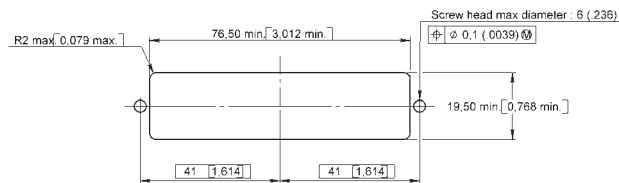
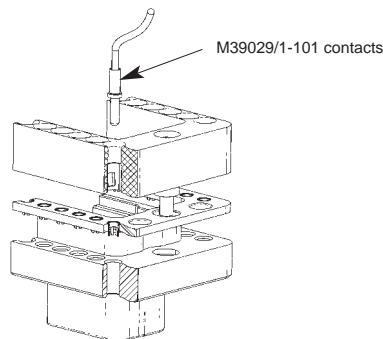

Panel Cut Out
Modification Code D and L

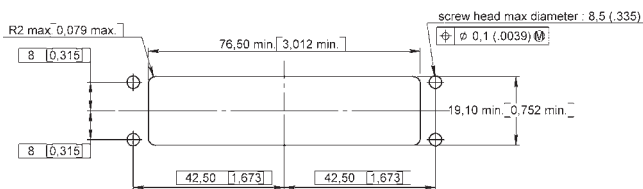

Panel Cut Out
Modification Code A

Note 1: Maximum dimension for inserts with grommets (Part Number GPRBE and GPRBH)

GPRB2 Vertical (Square) Shell and Strain Relief Dimensions

Shell Kits with Two Cavities for Key-A Inserts

¹Kit: Shell & A-F hardware unassembled
²Assembly: Hardware assembled in polarization position E

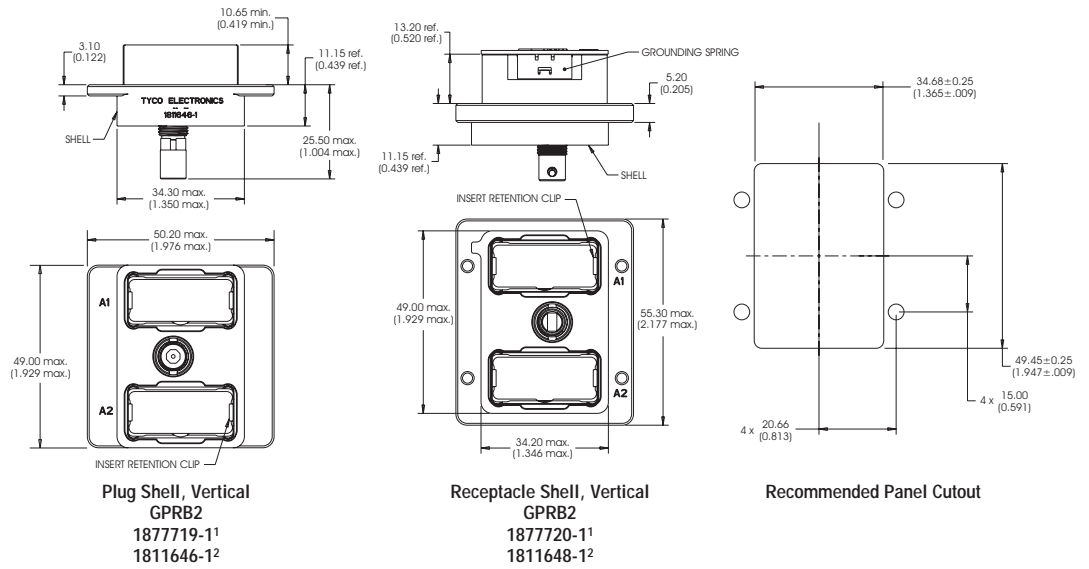

Shell Kits with Two Cavities for Key-A and Key-B Inserts

¹Kit: Shell & A-F hardware unassembled

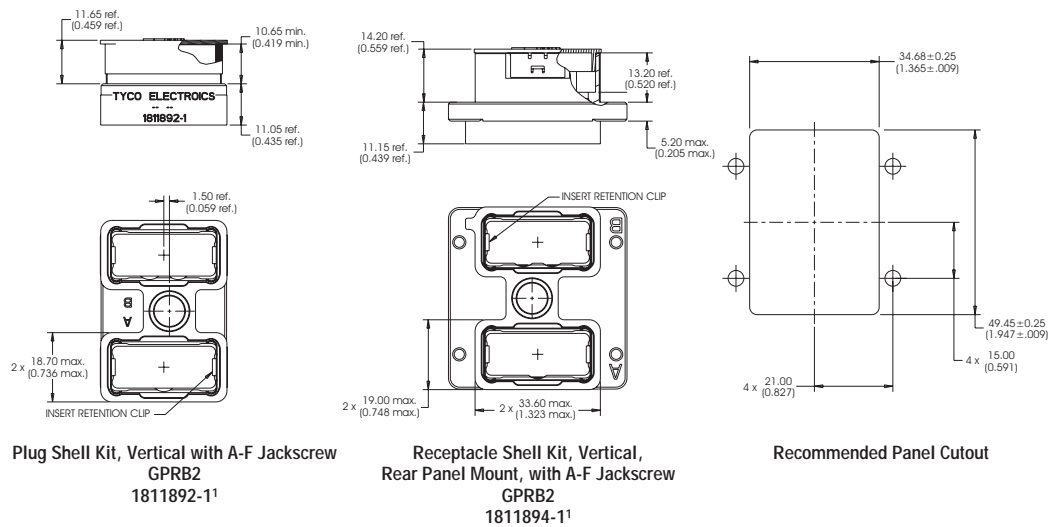

Strain Relief Kit, Vertical GPRB2

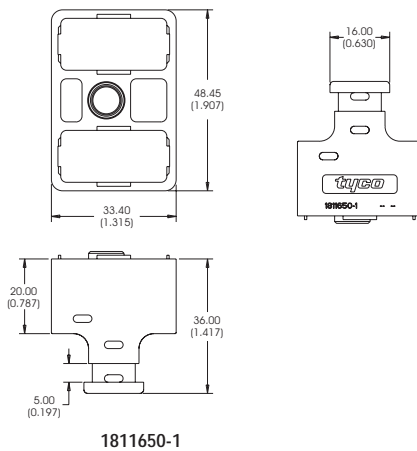

Descriptive Part Numbering System

Use this guide to construct descriptive part numbers for GPR & B inserts. Refer to pages 15–18 for the corresponding Tyco Electronics Part Number.

Insert Descriptive Part Number Format

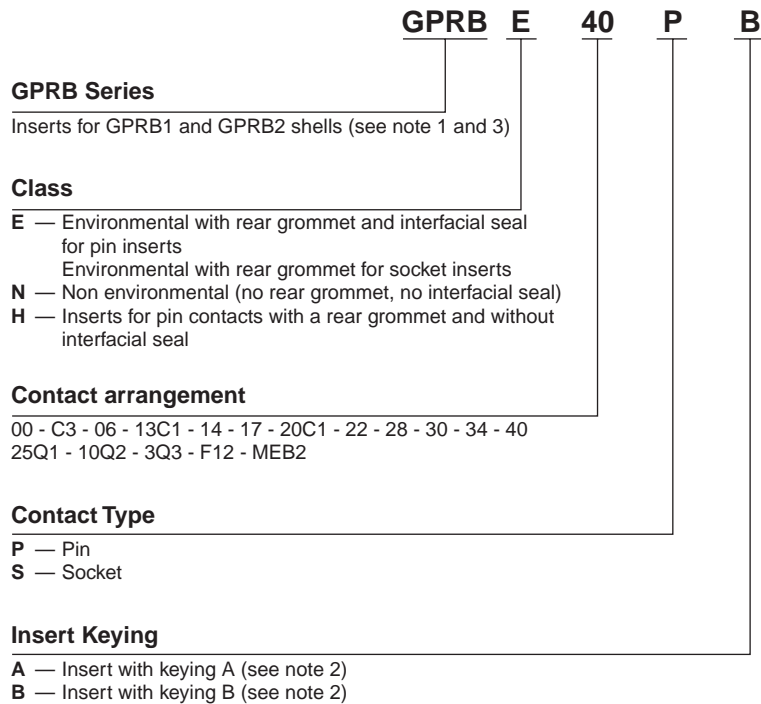
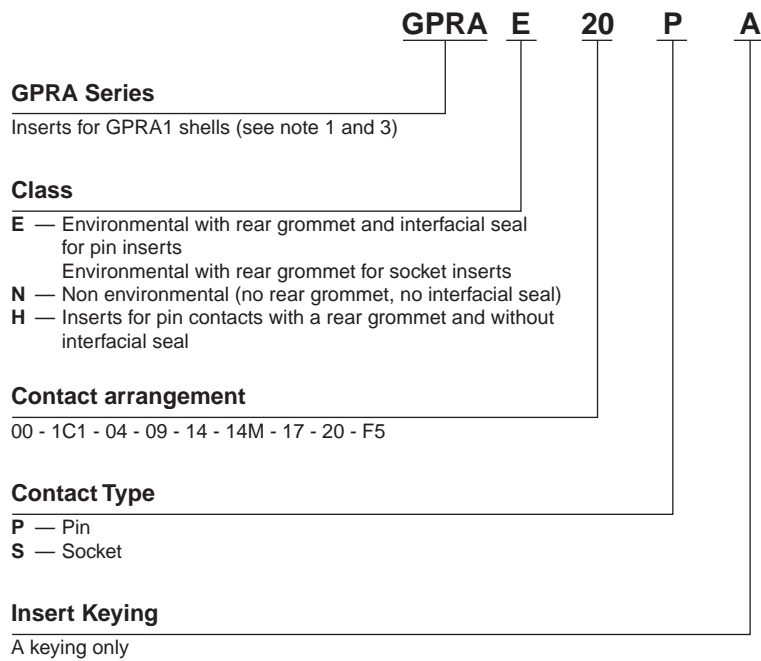

- Notes: 1. Inserts are designed for rear release contacts.
 2. For GPRB2 shells, use one insert keyed A and one insert keyed B. For GPRB1 shells, use one insert keyed A only.
 3. Pin and socket inserts can be installed in either plug or receptacle shell.

GPRA Insert Part Numbers

Series	Contact Arrangement	Contact Type	Classification	Keying	Descriptive Part Number	Tyco Electronics Part Number	
A	00	N/A	Dummy Insert	N/A	GPRAN00	1738049-1	
			Environmental, with Rear Grommet & Interfacial Seal		GPRAE1C1PA	1738050-1	
			Insert with Rear Grommet, without Interfacial Seal		GPRAH1C1PA	1738051-1	
	1C1	Pin		Non-environmental (no Grommet or Seal)		GPRAN1C1PA	1738052-1
				Environmental, with Rear Grommet		GPRAE1C1SA	1738053-1
				Non-environmental (no Grommet or Seal)		GPRAN1C1SA	1738054-1
		Socket		Environmental, with Rear Grommet & Interfacial Seal		GPRAE04PA	1738055-1
				Insert with Rear Grommet, without Interfacial Seal		GPRAH04PA	1738056-1
				Non-environmental (no Grommet or Seal)		GPRAN04PA	1738057-1
	04	Pin		Environmental, with Rear Grommet		GPRAE04SA	1738058-1
				Non-environmental (no Grommet or Seal)		GPRAN04SA	1738059-1
				Environmental, with Rear Grommet & Interfacial Seal		GPRAE09PA	1738060-1
		Socket		Insert with Rear Grommet, without Interfacial Seal		GPRAH09PA	1738061-1
				Non-environmental (no Grommet or Seal)		GPRAN09PA	1738062-1
				Environmental, with Rear Grommet		GPRAE09SA	1738063-1
	09	Pin		Non-environmental (no Grommet or Seal)	A	GPRAN09SA	1738064-1
				Environmental, with Rear Grommet & Interfacial Seal		GPRAE14PA	1738065-1
				Insert with Rear Grommet, without Interfacial Seal		GPRAH14PA	1738066-1
		Socket		Non-environmental (no Grommet or Seal)		GPRAN14PA	1738067-1
				Environmental, with Rear Grommet		GPRAE14SA	1738068-1
				Non-environmental (no Grommet or Seal)		GPRAN14SA	1738069-1
	14M	Pin		Environmental, with Rear Grommet & Interfacial Seal		GPRAE14MPA	1738070-1
				Insert with Rear Grommet, without Interfacial Seal		GPRAH14MPA	1738071-1
				Non-environmental (no Grommet or Seal)		GPRAN14MPA	1738072-1
Socket			Environmental, with Rear Grommet	GPRAE14MSA		1738073-1	
			Non-environmental (no Grommet or Seal)	GPRAN14MSA		1738074-1	
			Environmental, with Rear Grommet & Interfacial Seal	GPRAE17PA		1738075-1	
17	Pin		Insert with Rear Grommet, without Interfacial Seal		GPRAH17PA	1738076-1	
			Non-environmental (no Grommet or Seal)		GPRAN17PA	1738077-1	
			Environmental, with Rear Grommet		GPRAE17SA	1738078-1	
	Socket		Non-environmental (no Grommet or Seal)		GPRAN17SA	1738079-1	
			Environmental, with Rear Grommet & Interfacial Seal		GPRAE20PA	1738080-1	
			Insert with Rear Grommet, without Interfacial Seal		GPRAH20PA	1738081-1	
20	Pin		Non-environmental (no Grommet or Seal)		GPRAN20PA	1738082-1	
			Environmental, with Rear Grommet		GPRAE20SA	1738083-1	
			Non-environmental (no Grommet or Seal)		GPRAN20SA	1738084-1	
	Socket		Environmental, without Sleeve Holder			GPRAEF5PA	1954043-1
			Environmental, with Sleeve Holder			GPRAEF5SA	1954044-1

LuxCis is a trademark of Radiall S.A.
Product is manufactured under license
from Radiall S.A.

GPRB Insert Part Numbers

Series	Contact Arrangement	Contact Type	Classification	Keying	Descriptive Part Number	Tyco Electronics Part Number		
B	00	N/A	Dummy Insert	N/A	GPRBN00	1738085-1		
			Environmental, with Rear Grommet & Interfacial Seal	A	GPRBEC3PA	1738086-1		
	C3	Pin	Insert with Rear Grommet, without Interfacial Seal	B	GPRBEC3PB	1738091-1		
				A	GPRBHC3PA	1738087-1		
			Non-environmental (no Grommet or Seal)	B	GPRBHC3PB	1738092-1		
				A	GPRBNC3PA	1738088-1		
	C3	Socket	Environmental, with Rear Grommet	B	GPRBNC3PB	1738093-1		
				A	GPRBEC3SA	1738089-1		
			Non-environmental (no Grommet or Seal)	B	GPRBEC3SB	1738094-1		
				A	GPRBNC3SA	1738090-1		
			Non-environmental (no Grommet or Seal)	B	GPRBNC3SB	1738095-1		
				A	GPRBE06PA	1738096-1		
	06	Pin	Environmental, with Rear Grommet & Interfacial Seal	B	GPRBE06PB	1738101-1		
				A	GPRBH06PA	1738097-1		
			Insert with Rear Grommet, without Interfacial Seal	B	GPRBH06PB	1738102-1		
				A	GPRBN06PA	1738098-1		
			Non-environmental (no Grommet or Seal)	B	GPRBN06PB	1738103-1		
				A	GPRBE06SA	1738099-1		
	06	Socket	Environmental, with Rear Grommet	B	GPRBE06SB	1738104-1		
				A	GPRBN06SA	1738100-1		
			Non-environmental (no Grommet or Seal)	B	GPRBN06SB	1738105-1		
				A	GPRBE13C1PA	1738106-1		
			13C1	Pin	Environmental, with Rear Grommet & Interfacial Seal	B	GPRBE13C1PB	1738111-1
						A	GPRBH13C1PA	1738107-1
Insert with Rear Grommet, without Interfacial Seal	B	GPRBH13C1PB			1738112-1			
	A	GPRBN13C1PA			1738108-1			
Non-environmental (no Grommet or Seal)	B	GPRBN13C1PB			1738113-1			
	A	GPRBE13C1SA			1738109-1			
13C1	Socket	Environmental, with Rear Grommet	B	GPRBE13C1SB	1738114-1			
			A	GPRBN13C1SA	1738110-1			
		Non-environmental (no Grommet or Seal)	B	GPRBN13C1SB	1738115-1			
			A	GPRBE14PA	1738116-1			
		14	Pin	Environmental, with Rear Grommet & Interfacial Seal	B	GPRBE14PB	1738121-1	
					A	GPRBH14PA	1738117-1	
Insert with Rear Grommet, without Interfacial Seal	B			GPRBH14PB	1738122-1			
	A			GPRBN14PA	1738118-1			
Non-environmental (no Grommet or Seal)	B			GPRBN14PB	1738123-1			
	A			GPRBE14SA	1738119-1			
14	Socket	Environmental, with Rear Grommet	B	GPRBE14SB	1738124-1			
			A	GPRBN14SA	1738120-1			
		Non-environmental (no Grommet or Seal)	B	GPRBN14SB	1738125-1			
			A	GPRBE17PA	1738126-1			
		17	Pin	Environmental, with Rear Grommet & Interfacial Seal	B	GPRBE17PB	1738131-1	
					A	GPRBH17PA	1738127-1	
Insert with Rear Grommet, without Interfacial Seal	B			GPRBH17PB	1738132-1			
	A			GPRBN17PA	1738128-1			
Non-environmental (no Grommet or Seal)	B			GPRBN17PB	1738133-1			
	A			GPRBE17SA	1738129-1			
17	Socket	Environmental, with Rear Grommet	B	GPRBE17SB	1738134-1			
			A	GPRBN17SA	1738130-1			
		Non-environmental (no Grommet or Seal)	B	GPRBN17SB	1738135-1			
			A					

GPRB Insert Part Numbers (Continued)

Series	Contact Arrangement	Contact Type	Classification	Keying	Descriptive Part Number	Tyco Electronics Part Number		
B	20C1	Pin	Environmental, with Rear Grommet & Interfacial Seal	A	GPRBE20C1PA	1738136-1		
				B	GPRBE20C1PB	1738141-1		
			Insert with Rear Grommet, without Interfacial Seal	A	GPRBH20C1PA	1738137-1		
				B	GPRBH20C1PB	1738142-1		
			Non-environmental (no Grommet or Seal)	A	GPRBN20C1PA	1738138-1		
				B	GPRBN20C1PB	1738143-1		
		Socket	Environmental, with Rear Grommet	A	GPRBE20C1SA	1738139-1		
				B	GPRBE20C1SB	1738144-1		
			Non-environmental (no Grommet or Seal)	A	GPRBN20C1SA	1738140-1		
				B	GPRBN20C1SB	1738145-1		
			22	Pin	Environmental, with Rear Grommet & Interfacial Seal	A	GPRBE22PA	1738146-1
						B	GPRBE22PB	1738151-1
	Insert with Rear Grommet, without Interfacial Seal	A			GPRBH22PA	1738147-1		
		B			GPRBH22PB	1738152-1		
	Non-environmental (no Grommet or Seal)	A			GPRBN22PA	1738148-1		
		B			GPRBN22PB	1738153-1		
	Socket	Environmental, with Rear Grommet		A	GPRBE22SA	1738149-1		
				B	GPRBE22SB	1738154-1		
		Non-environmental (no Grommet or Seal)		A	GPRBN22SA	1738150-1		
				B	GPRBN22SB	1738155-1		
		28		Pin	Environmental, with Rear Grommet & Interfacial Seal	A	GPRBE28PA	1738156-1
						B	GPRBE28PB	1738161-1
	Insert with Rear Grommet, without Interfacial Seal		A		GPRBH28PA	1738157-1		
			B		GPRBH28PB	1738162-1		
	Non-environmental (no Grommet or Seal)		A		GPRBN28PA	1738158-1		
			B		GPRBN28PB	1738163-1		
	Socket		Environmental, with Rear Grommet	A	GPRBE28SA	1738159-1		
				B	GPRBE28SB	1738164-1		
			Non-environmental (no Grommet or Seal)	A	GPRBN28SA	1738160-1		
				B	GPRBN28SB	1738165-1		
			30	Pin	Environmental, with Rear Grommet & Interfacial Seal	A	GPRBE30PA	1738166-1
						B	GPRBE30PB	1738171-1
	Insert with Rear Grommet, without Interfacial Seal	A			GPRBH30PA	1738167-1		
		B			GPRBH30PB	1738172-1		
	Non-environmental (no Grommet or Seal)	A			GPRBN30PA	1738168-1		
		B			GPRBN30PB	1738173-1		
	Socket	Environmental, with Rear Grommet		A	GPRBE30SA	1738169-1		
				B	GPRBE30SB	1738174-1		
		Non-environmental (no Grommet or Seal)		A	GPRBN30SA	1738170-1		
				B	GPRBN30SB	1738175-1		
		34		Pin	Environmental, with Rear Grommet & Interfacial Seal	A	GPRBE34PA	1738176-1
						B	GPRBE34PB	1738181-1
	Insert with Rear Grommet, without Interfacial Seal		A		GPRBH34PA	1738177-1		
			B		GPRBH34PB	1738182-1		
	Non-environmental (no Grommet or Seal)		A		GPRBN34PA	1738178-1		
			B		GPRBN34PB	1738183-1		
	Socket		Environmental, with Rear Grommet	A	GPRBE34SA	1738179-1		
				B	GPRBE34SB	1738184-1		
Non-environmental (no Grommet or Seal)			A	GPRBN34SA	1738180-1			
			B	GPRBN34SB	1738185-1			
40			Pin	Environmental, with Rear Grommet & Interfacial Seal	A	GPRBE40PA	1738186-1	
					B	GPRBE40PB	1738191-1	
	Insert with Rear Grommet, without Interfacial Seal	A		GPRBH40PA	1738187-1			
		B		GPRBH40PB	1738192-1			
	Non-environmental (no Grommet or Seal)	A		GPRBN40PA	1738188-1			
		B		GPRBN40PB	1738193-1			
	Socket	Environmental, with Rear Grommet	A	GPRBE40SA	1738189-1			
			B	GPRBE40SB	1738194-1			
		Non-environmental (no Grommet or Seal)	A	GPRBN40SA	1738190-1			
			B	GPRBN40SB	1738195-1			

GPRB Insert Part Numbers (Continued)

Series	Contact Arrangement	Contact Type	Classification	Keying	Descriptive Part Number	Tyco Electronics Part Number	
B	25Q1	Pin	Environmental, with Rear Grommet & Interfacial Seal	A	GPRBE25Q1PA	1811121-1	
				B	GPRBE25Q1PB	1877567-1	
		Socket	Environmental, with Rear Grommet	A	GPRBE25Q1SA	1811122-1	
				B	GPRBE25Q1SB	1877568-1	
	10Q2	Pin	Environmental, with Rear Grommet & Interfacial Seal	A	GPRBE10Q2PA	1877702-1	
				B	GPRBE10Q2PB	1877706-1	
		Socket	Environmental, with Rear Grommet	A	GPRBE10Q2SA	1877704-1	
				B	GPRBE10Q2SB	1877708-1	
			Non-environmental (no Grommet or Seal)	A	GPRBN10Q2SA	1954067-1	
	3Q3			Environmental, with Rear Grommet & Interfacial Seal	A	GPRBE3Q3PA	1877694-1
				Environmental, with Rear Grommet	A	GPRBE3Q3SA	1877696-1
	F12	LuxCis Termini		Environmental, without Sleeve Holder	A	GPRBEF12PA	1738805-1
					B	GPRBEF12PB	1738806-1
Environmental, with Sleeve Holder				A	GPRBEF12SA	1738807-1	
				B	GPRBE2F12SB	1738808-1	
M2	Mini-Expanded Beam		Spring-loaded Half	A	GPRBEM2PA	1445162-1	
			Fixed Half	A	GPRBEM2SA	1445163-1	

Insert Arrangements

GPR A Inserts¹

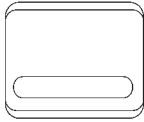

00
Dummy Insert

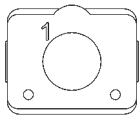

1C1
1 x Size 5 Contacts

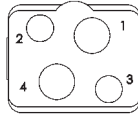

04
2 x Size 15 or 16 Contacts
2 x Size 12 Contacts

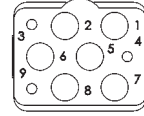

09
3 x Size 20 Contacts
6 x Size 15 or 16 Contacts

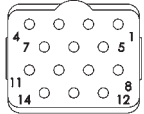

14
14 x Size 20 Contacts

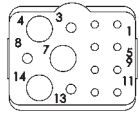

14M
8 x Size 22 Contacts
3 x Size 20 Contacts
3 x Size 15 or 16 Contacts

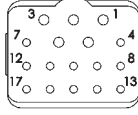

17
12 x Size 22 Contacts
5 x Size 20 Contacts

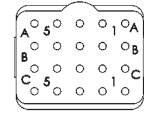

20
20 x Size 22 Contacts

GPR B Inserts^{1, 2}



00
Dummy Insert

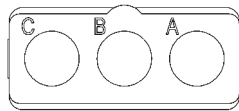

C3
3 x Size 5 Contacts

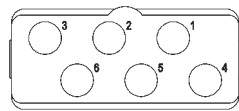

06
6 x Size 12 Contacts

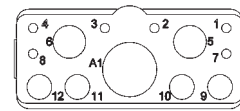

13C1
2 x Size 12 Contacts
4 x Size 15 or 16 Contacts
6 x Size 20 Contacts
1 x Size 5 Contacts

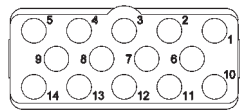

14
14 x Size 15 or 16 Contacts

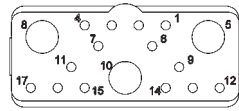

17
14 x Size 20 Contacts
3 x Size 12 Contacts

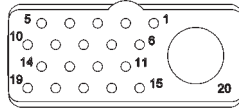

20C1
19 x Size 20 Contacts
1 x Size 5 Contacts

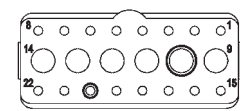

22
16 x Size 20 Contacts
6 x Size 15 or 16 Contacts

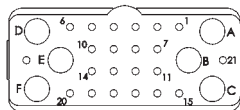

28
22 x Size 22 Contacts
6 x Size 15 or 16 Contacts

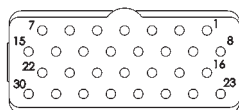

30
30 x Size 20 Contacts

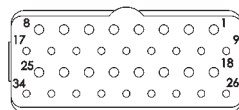

34
18 x Size 22 Contacts
16 x Size 20 Contacts

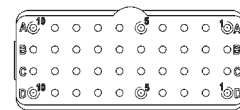

40
40 x Size 22 Contacts

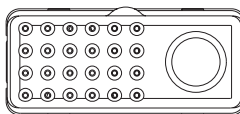

25QI³

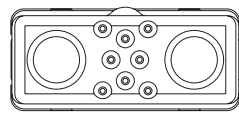

10Q2³

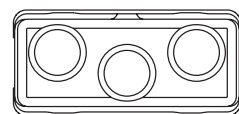

30Q3

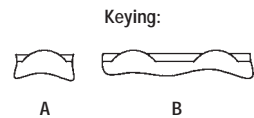

Keying:

A

B

Note

¹ Pin inserts: Mating faces shown above.

² In a GPRB2 shell, one insert must be "A" keyed and the other one must be "B" keyed (See at right).

³ Size 8 cavity applicable for use with ARINC 600 Quadrax or Twinax contacts.

Insert Assemblies for High Speed Applications

F12 LuxCis® Insert Assemblies



Product Facts

- ARINC 801 approved
- Optical termini for use with GPR, ARINC 600, circular MIL-DTL-38999 connectors.
- Industry Standard 1.25mm ceramic ferrule
- Compatible with 1.5-2.2mm tight jacket and loose tube cable construction:
 - MT - Tight jacket cable
 - ML – Loose tube cable
- SingleMode (SM) and MultiMode (MM) versions
- LuxCis® termini part numbers:
 - 1828199-1 MM/ML Version
 - 1828200-1 MM/MT Version
 - 1918614-1 SM/ML Version
 - 1918616-1 SM/ML Version-APC
 - 1918615-1 SM/MT Version
 - 1918617-1 SM/MT Version - APC

Materials:

- Housings – Nickel Plated Copper
- Ferrule – Zirconia
- Spring – Stainless Steel
- Crimp Sleeve – Nickel Plated Copper
- Protective Cover – Silicone

Optical Performance

- Single mode, 1310nm/1550nm (UPC)
 - Attenuation, Mean – 0.15dB
 - Return Loss - >50dB
- Multimode, 850nm,1310nm
 - Attenuation, Mean – 0.10dB
 - Return Loss - >20dB

Assembly Capabilities

Tyco Electronics has extensive Rugged Optic Harness capabilities. Please consult your local Tyco Electronics Sales Representative for assistance.

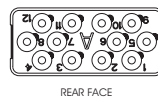
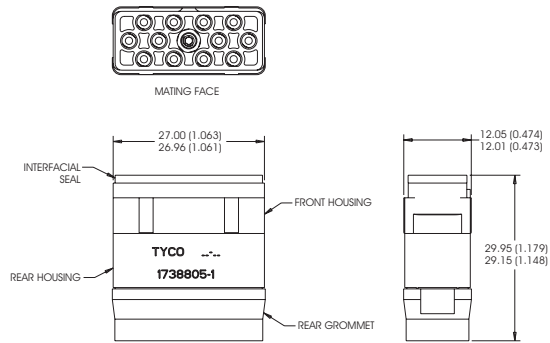

Insert Assembly, without Sleeve Holder, Environmental, F12 Key A 1738805-1 Key B 1738806-1

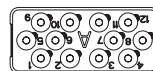
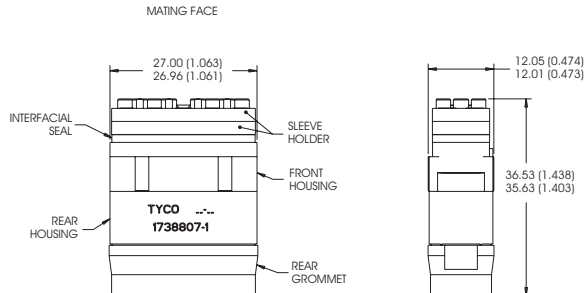
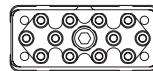

Insert Assembly, with Sleeve Holder, Environmental, F12, Key A GPRB Key A 1738807-1 Key B 1738808-1

LuxCis® Optical Termini Part Numbers

Cable Dia.	Cable Structure ML (loose & tight) MT (ultra tight)	S/M Fiber 125,3 µm PC/UPC	S/M Fiber 125,3 µm APC	M/M Fiber 128 µm PC
0.9mm Buffer	—	*	*	*
1.5 - 2.2mm	ML	1918614-1	1918616-1	1828199-1
1.5 - 2.2mm	MT	1918615-1	1918617-1	1828200-1

Consult your local Tyco Electronics Sales Representative for additional options.
* Contact Tyco Electronics for availability.

LuxCis is a trademark of Radiall, S.A. Product is manufactured under license from Radiall S.A.

Insert Assemblies for High Speed Applications (Continued)

M2 Mini-Expanded Beam Insert Holders

Product Facts

- No wear on fiber optic interface; Very vibration resistant
- Easy to handle, easy to clean. Durable connection that is highly resistant to dirt/debris.
- Singlemode or multimode
- Common 850/1300 Dual Wavelength, 1310, or 1550 nm wavelengths
- Easy alignment for low-loss repeatable performance
- Consistent overall optical "link budget" assured
- Low sensitivity to thermal fluctuations and interface contamination
- Repeatable low-loss performance in harsh environments.

Expanded Beam Products

- Ball lens expands cross-sectional area of light over 200 times for multimode and over 2000 times for singlemode
- Rugged hermaphroditic construction (i.e., same insert mates to each other)
- Physically non-contacting mating conditions; no wear, installed fiber ferrule protected by ball lens
- PRO BEAM Mini Connector field deployable interconnects
- Insert/holder blocks designed for Mini-Expanded Beam
- Common insert for 1- through 4-channels
- Unique Modular Design, for use with multimode and singlemode fiber.
- Cable assembly and termination services

Expanded Beam Insert

- Mini-Expanded Beam insert for multi-channel small form factor – the smallest expanded beam multi-channel insert in the industry a Tyco Electronics exclusive.

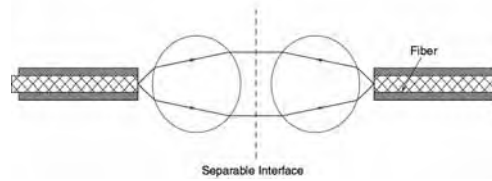

Expanded Beam Principle

Fiber Optic interconnect/cable system using Expanded Beam technology, which physically expands and collimates the transmission signal into an optical beam over 14 times its original diameter (the cross sectional area of the light beam increases over 200 times for multimode optical signals). For single-mode signals, the collimated beam is over 45 times its original diameter (the cross-

sectional area of the light beam increases over 2,000 times). It is then refocused back down onto the core of the receiving fiber. This approach provides ease of alignment and low sensitivity to thermal changes and contamination. High strength, precision connector housings enhance a durable connection, optimizing low loss and repeatable performance.

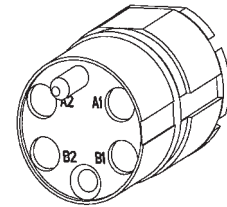

Expanded Beam Inserts

Suitable for aerospace, avionics, field-deployable communications, marine ship-to-shore applications, security systems, mobile diagnostic units, oil and gas exploration and other harsh environment applications demanding strength, durability and reliable performance in conditions of multiple couplings/decouplings, blindmate situations, and high vibration.

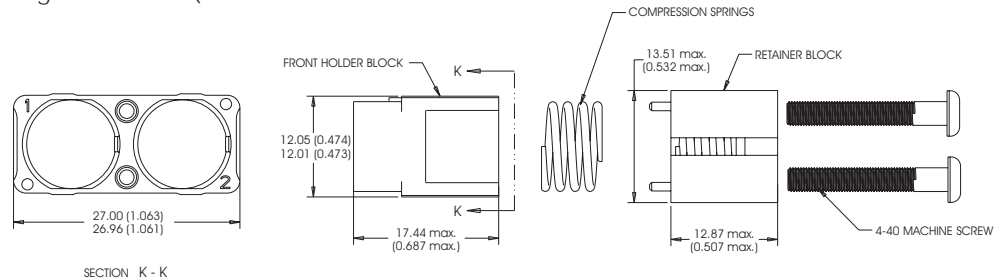

MINI-E BEAM HOLDER KIT
Holder Kit, Pin (Spring-Loaded),
Mini-Expanded Beam, Key A
GPRB
1445162-1

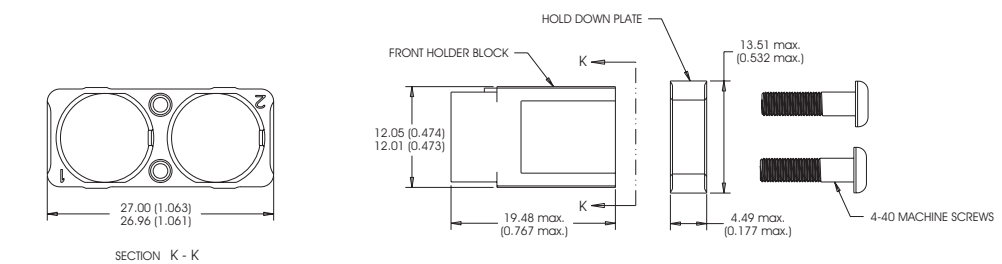

MINI-E BEAM HOLDER KIT
Holder Kit, Socket (Fixed),
Mini-Expanded Beam, Key A
GPRB
1445163-1

Assembly Capabilities

Tyco Electronics has extensive Rugged Optic Harness capabilities. Please consult your local Tyco Electronics Sales Representative for assistance.

Contact and Application Tool Part Numbers

Form	Contact Size	Wire Size	Type	Contacts Tyco P/N	Contact Crimp Tools & Positioners				Contact Insertion/Extraction Tools	
					Crimp Tool Tyco P/N	Crimp Tool MIL P/N	Positioner Tyco P/N	Positioner MIL P/N	Tyco Part Number	MIL Part Number
Crimp Contacts	22	22 - 24 - 26	Pin	1738007-1	601966-1	M22520/2-01	601966-8	M22520/2-23	91066-1	M81969/1-01
			Socket	1738008-1						
	22 - Reduced Crimp Barrel	28 - 30	Pin	1738009-1						
			Socket	1738010-1						
	20	20 - 22 - 24	Pin	1738011-1						
			Socket	1738012-1						
	16	16 - 18 - 20	Pin	1738013-1						
			Socket	1738014-1						
	16 - Reduced Crimp Barrel	20 - 22 - 24	Pin	1738015-1						
			Socket	1738016-1						
12	12 - 14	Pin	1738017-1							
		Socket	1738018-1							
5	8 - 10	Pin	1738019-1	N/A	M22520/23-01 & M22520/23-02	Locator 1738331-1	N/A	1811509-1	M81969/28-01	
		Socket	1738020-1							
16 - Mating End 20-Crimp Barrel	20 - 22 - 24	Ground Block Contact	2-592404-1 M39029/1-101	601966-1	M22520/2-01	N/A	M22520/2-02 or /2-11	592105-1	M81969/14-11 or /14-02	

Form	Contact Size	Wire Size	Type	Contacts Tyco P/N	Center Conductor / Contact Crimp Tools & Positioners				Outer Conductor Crimp Tools & Die Sets			
					Crimp Tool Tyco P/N	Crimp Tool MIL P/N	Positioner Tyco P/N	Positioner MIL P/N	Crimp Tool Tyco P/N	Crimp Tool MIL P/N	Die Set Tyco P/N	Die Set MIL P/N
Coaxial Crimp Contacts	5	RG142 RG223 KX23	Pin	1738021-1	601966-1	M22520/2-01	1738332-1	N/A	608650-1	M22520/5-01	1738336-1	M22520/5-05
			Socket	1738022-1								
	5	RG174 RG316 KX22	Pin	1738023-1								
			Socket	1738024-1								
	15	RG174 RG179 RG316 - KX22	Pin	1738025-1								
			Socket	1738026-1								
	15	RG178 KX21 ST	Pin	1738027-1								
			Socket	1738028-1								
	15	KX21 DT	Pin	1738029-1								
			Socket	1738030-1								
15	UT .047	Pin	1738031-1									
		Socket	1738032-1									
Concentric Twinax Crimp Contacts	5	PAN61421 M17/176-0002	Pin	1738033-1	608650-1	M22520/5-01	1738338-1	N/A	608650-1	M22520/5-01	1738336-1	M22520/5-05
			Socket	1738034-1								

Form	Contact Size	Hex Crimp Number	Reference Cables	Type	Contacts Tyco P/N
ARINC 600 QUADRAX Contacts	8	0.218	Tensolite NF24Q100, NF26Q100, 24443/03130X-4 (LD), 2443/P025X-4 (LD), Raychem CEC-RWC-18687, CEC-RWC-18664	Pin	1445692-1
				Socket	1445693-1
			DRAKA F4703-3, F4704-4	Pin	1445692-6
				Socket	1445693-6
			Tensolite 26473/02006X-4 (LD), Raychem CEC-RWC-18684, CEC-RWC-18680	Pin	1877039-1
				Socket	1877040-1
Non-Concentric TWINAX Contacts	8	—	Raychem 100 Twinax 0024T1426	Seal Assembly	1877626-1
				Pin	1811865-1
				Socket	1811866-1
				Seal Assembly	1954046-1

PC Tail Contacts

Inserts pre-assembled with PC tail contacts with straight or right-angle termination are available — Consult Tyco Electronics.

Contact Size	Type	Configuration	Tyco Part Number	Contact Insertion/Extraction Tools	
				Tyco Part Number	MIL Part Number
22	Pin	Straight	1738709-1	91066-1	M81969/1-01
20	Pin	Straight	1738710-1	91067-2	M81969/1-02
12	Pin	Straight	1738711-1	1738327-1	M81969/28-02

LuxCis® Optical Termini
Part Numbers

Contact and Application Tool Part Numbers (Continued)

Cable Dia.	Cable Structure ML (loose & tight) MT (ultra tight)	S/M Fiber 125,3 µm PC/UPC	S/M Fiber 125,3 µm APC	M/M Fiber 128 µm PC
0.9mm Buffer	—	*	*	*
1.5 - 2.2mm	ML	1918614-1	1918616-1	1828199-1
1.5 - 2.2mm	MT	1918615-1	1918617-1	1828200-1

Consult your local Tyco Electronics Sales Representative for additional options.
* Contact Tyco Electronics for availability.

Spare Parts and Tools

Spare Parts

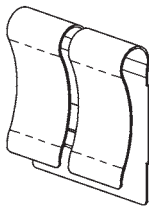

Grounding Spring
Part Number 1738199-1

GPRA and GPRB Series

Part Number	Description	To Be Used With
1738199-1	Grounding Spring	GPRA
1738200-1	Dust Cap – Plug Shell	GPRA
1738201-1	Dust Cap – Receptacle Shell	GPRA
1738203-1	Jacknut – A/B/C/D/E/F	GPRB2
1738204-1	Jacknut – N/R/W/X/Y/Z	GPRB2
1738205-1	Jackscrew – A/B/C/D/E/F	GPRB2
1738206-1	Jackscrew – N/R/W/X/Y/Z	GPRB2
1738207-1	Socket Polarization Guide – A/B/C/D/E/F	GPRB2 Rack & Panel application
1738208-1	Socket Polarization Guide – N/R/W/X/Y/Z	GPRB2 Rack & Panel application
1738209-1	Pin Polarization Guide – A/B/C/D/E/F	GPRB2 Rack & Panel application
1738210-1	Pin Polarization Guide – N/R/W/X/Y/Z	GPRB2 Rack & Panel application
1738213-1	Dust Cap – Plug Shell	GPRB1
1738214-1	Dust Cap – Receptacle Shell	GPRB1
1738211-1	Dust Cap – Plug Shell	GPRB2
1738212-1	Dust Cap – Receptacle Shell	GPRB2
1877328-1	Anti-Static Dust Cap – Plug Shell	GPRB2
1877329-1	Anti-Static Dust Cap – Receptacle Shell	GPRB2
1738400-1	Grounding Spring	GPRB1 & B2
1738428-1	Polarization Key, Male	GPRA & GPRB1
1738429-1	Polarization Key, Female	GPRA & GPRB1
1738440-1	Key Retention Plate Assembly	GPRA & GPRB1

Tools

GPRA and GPRB Series

Part Number	Description	To Be Used With
1738215-1	Insert extraction tool	GPRA
1738216-1	Allen wrench locking system	GPRA, GPRB1
1738217-1	Insert handling case	GPRA, GPRB1 & B2
1738218-1	Insert extraction tool	GPRB1 & B2
1738219-1	Right-angle insert extraction tool	GPRB1 & B2
1738220-1	Spigot wrench for locking device w/1/4 inch adapter	GPRB2
1738221-1	Spigot wrench for locking device w/handle	GPRB2

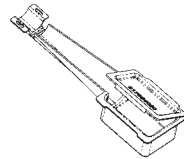

Insert Handling Case
Part Number 1738217-1

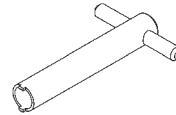

Spigot Wrench for Locking Device with
Handle
Part Number 1738221-1

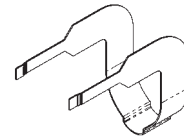

Right-Angle Insert Extraction Tool
Part Number 1738219-1

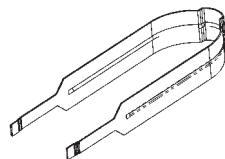

Insert Extraction Tool
Part Number 1738218-1



Stainless steel testing tools are available to check the wiring of the inserts without the shell — Consult Tyco Electronics.

LuxCis is a trademark of Radiall, S.A. Product is manufactured under license from Radiall S.A.

EMI Backshells and Strain Reliefs

GPRB Series

Part Number	Description	Used With
1738310-1	Straight strain relief	GPRB1
1738311-1	45° strain relief	GPRB1
1738312-1	Straight backshell	GPRB1
1738313-1	Straight strain relief	GPRB2
1738314-1	Backshell for shielded termination	GPRB2
1738315-1	Backshell for screened twisted-pair cables	GPRB2
1738316-1	Backshell for large sized wire harnesses	GPRB2
1811650-1	Straight Strain Relief	GPRB2-Vertical
1877338-1	90° Exit Backshell	GPRB2

GPRA Series

Part Number	Description
1738317-1	Straight strain relief
1738318-1	45° strain relief
1738319-1	Straight backshell

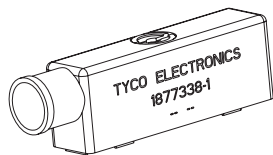

Backshell Kit, 90° Exit
Part Number 1877338-1

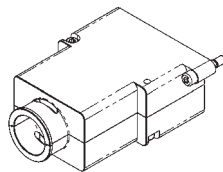

Straight Backshell
Part Number 1738312-1

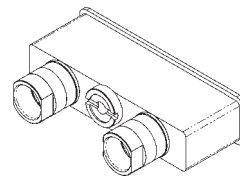

Backshell for
Shielded Termination
Part Number 1738314-1

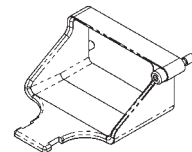

Straight Strain Relief
Part Number 1738310-1

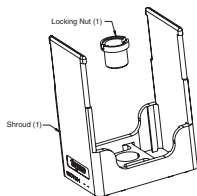

Vertical Strain Relief Kit, Fiber Optic
Part Number 1877736-1

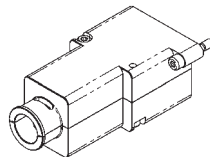

Straight Backshell
Part Number 1738319-1

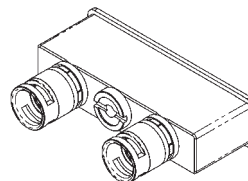

Backshell for Screened
Twisted Pair Cables
Part Number 1738315-1

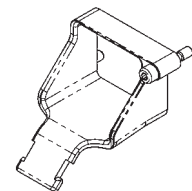

45° Strain Relief
Part Number 1738318-1

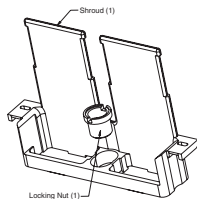

Horizontal Strain Relief Kit, Fiber Optic
Part Number 1877888-1

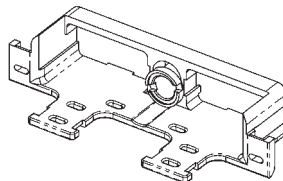

Straight Strain Relief
Part Number 1738313-1

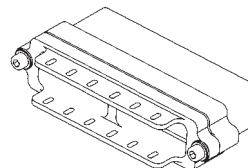

Backshell for Large Sized
Wire Harnesses
Part Number 1738316-1

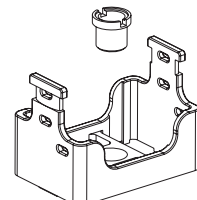

GPRB2 Vertical Strain Relief
Part Number 1811650-1

Galley Insert (GAIN) Connectors



Product Facts

- Designed for ARINC 810 – standard interfaces for Galley Insert (GAIN) Equipment
- Spring-Loaded, float-mounting plug shell design allows ±1mm variation in the mating direction
- Blind mating guide pin & socket accept ±2mm/ 2° lateral misalignment
- Product incorporates:
 - size 22 signal contacts
 - size 12 power contacts
 - size 8 twinax contacts
- 500 mating cycles durability

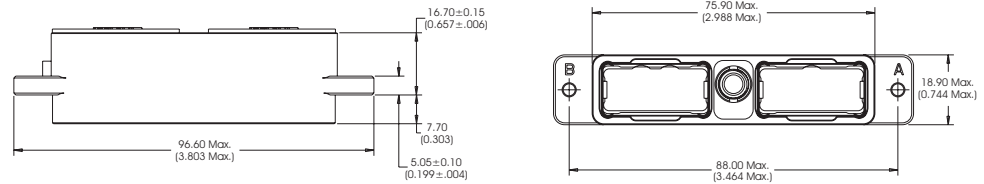

**Receptacle Shell, Front Panel Mount, with Guide Socket
GPRB2
1811119-1**

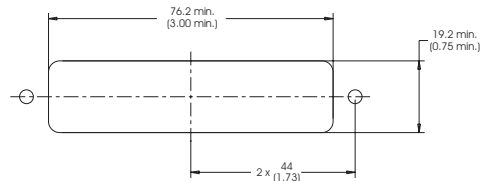

Recommended Panel Cutout

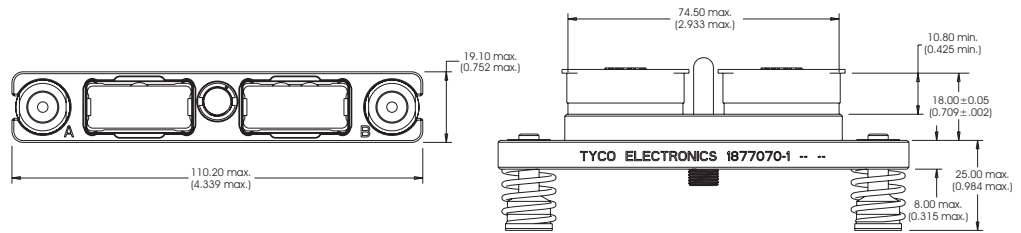

**Plug Shell, Spring-Loaded, Float-Mounting
GPRB2
1877070-1**

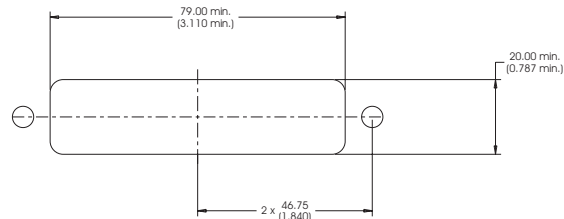

Recommended Panel Cutout

Description	Part Number	Ref. Catalog Page
Fully Assembled Receptacle	1877652-1	—
Fully Assembled Plug	1877646-1	—
Receptacle Shell Assembly	1811119-1	25
Plug Shell Assembly	1877070-1	25
25Q1 Pin Insert Assembly	1811121-1	18
25Q1 Socket Insert Assembly	1811122-1	18
06 Pin Insert Assembly	1738101-1	16
06 Socket Insert Assembly	1738104-1	16
Size 22 Pin Contact	1738007-1	22
Size 22 Socket Contact	1738008-1	22
Size 12 Pin Contact	1738017-1	22
Size 12 Socket Contact	1738018-1	22
Size 8 Twinax Pin Contact	1811865-1,-2	22
Size 8 Twinax Socket Contact	1811866-1,-2	22
Size 22 Sealing Plug	592104-4	—
Strain Relief (Straight)	1738313-1	24
Dust Cap, Plug	1738211-1	23
Dust Cap, Receptacle	1738212-1	23
Seal Assembly, Size 8, GPR	1954046-1	22
100 Twinax Raychem Cable	0024T1426	22

The GPRA & B Connector Series offers a comprehensive range of standard components that allows the user to build a connector to meet his requirements. However, standard shells might not be compatible with the user's application; alternate solutions are available to meet the customer's

specific requirements with limited investment by using standard inserts and contacts. Some of these are shown below.

Multicavity Racked Shells

GPRA shells can be built in any format from 4 to 20 cavities for either panel or rack applications and with or without grounding blocks. These shells accommodate standard inserts.



Solution for IMA (Integrated Modular Avionics)

A right-angle contact printed circuit board connector which allows direct mating with an airframe connector has been developed. It is fitted with special rack features: spring loaded shell, EMI shield frame and 4 polarization posts with 256 combinations.

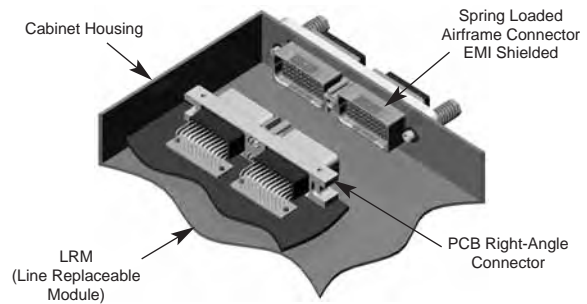

Composite Shells (in development)

Low weight, Skydrol® resistant composite shells have been developed.



Solutions for Data Bus

Tyco Electronics is at the leading edge of providing solutions for high-speed data transmission such as size 8 quadrx contacts for Ethernet.



Connectors for Size 3 Coaxial Contacts

A high-reliability design for high specification RF requirements.



Solutions for Wiring

Inserts may be fitted with internal bussed bars. This solution replaces junction blocks and simplifies the connector cabling.



Custom Shells

This custom 4-cavity receptacle shell was developed and serves as the rear panel of the customer's enclosure.



Custom Inserts

Inserts are available with PC Tail contacts pre-assembled, such as this 40-position pin assembly.

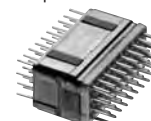

Americas

Argentina – Buenos Aires
 Phone: +54-11-4733-2200
 Fax: +54-11-4733-2211

Brasil – São Paulo
 Phone: +55-11-3611-1311
 Fax: +55-11-3611-0397

Canada – Toronto
 Phone: +905-475-6222
 Fax: +905-474-5520
Product Information Center:
(Technical Support)
 Phone: +905-470-4425
 Fax: +905-474-5525

Colombia – Bogota
 Phone: +57-1-231-9398
 Fax: +57-1-660-0206

Mexico – Mexico City
 Phone: +52-55-1106-0800
 Fax: +52-5-361-8545

United States – Harrisburg, PA
 Phone: +717-564-0100
 Fax: +717-986-7575
Product Information Center:
(Technical Support)
 Phone: +800-522-6752
 Fax: +717-986-7575

For Latin/South American Countries not shown
 Phone: +54-11-4733-2015
 Fax: +54-11-4733-2083

Asia/Pacific

Australia – Sydney
 Phone: +61-2-9554-2600
 Fax: +61-2-9502-2556
Product Information Center:
(Technical Support)
 Phone: +61-2-9840-8200
 Fax: +61-2-9634-6188

India – Bangalore
 Phone: +91-80-285-40800
 Fax: +91-80-285-40820

Indonesia – Jakarta
 Phone: +65-6482-0311
 Fax: +65-6482-1012

Japan – Toyko
 Phone: +81-44-844-8111
 Fax: +81-44-812-3207
Raychem & Identification Products
 Phone: +81-44-844-8183
 Fax: +81-44-844-8184
Product Information Center:
(Technical Support)
 Phone: +81-44-844-8013
 Fax: +81-44-812-3200

Korea – Seoul
 Phone: +82-2-3415-4500
 Fax: +82-2-3486-3810

Malaysia – Kuala Lumpur
 Phone: +60-3-78053055
 Fax: +60-3-78053066

New Zealand – Auckland
 Phone: +64-9-634-4580
 Fax: +64-9-634-4586

Philippines – Makati City
 Phone: +632-848-0171
 Fax: +632-867-8661

People's Republic of China
 Hong Kong
 Phone: +852-2735-1628
 Fax: +852-2735-0243

Shanghai
 Phone: +86-21-64857333/64850602
 Fax: +86-21-64856222/54261090

Singapore – Singapore
 Phone: +65-6482-0311
 Fax: +65-6482-1012

Raychem Products
 Phone: +65-4866-151
 Fax: +65-6545-514
Identification Products
 Phone: +65 (0) 6482-0311
 Fax: +65 (0) 6481-5514

Taiwan – Taipei
 Phone: +886-2-8768-2788
 Fax: +886-2-8768-2268

Thailand – Bangkok
 Phone: +66-2-955-0500
 Fax: +66-2-955-0505

Vietnam and Indochina –
 Ho Chi Minh City
 Phone: +84-8 930-5546
 Fax: +84-8 930-3443

Europe/Middle East/Africa

Austria – Vienna
 Phone: +43-1 90 5 60-0
 Fax: +43-1 90 5 60-1333

Belgium – Kessel-Lo
 Phone: +32-16-35-23-00
 Fax: +32-16-35-23-52

Bulgaria – Sofia
 Phone: +359-2-971-2152
 Fax: +359-2-971-2153

Czech Republic – Kurim
 Phone: +420-5-41-162-111
 Fax: +420-5-41-162-223

Denmark – Glostrup
 Phone: +45-43-480-452
 Fax: +45-43-441-414

Egypt – Cairo
 Phone: +20-2-29 04 281
 Fax: +20-2-41 92 334

Finland – Helsinki
 Phone: +358-95-12-34-20
 Fax: +358-95-12-34-250

France – Cergy-Pontoise
 Phone: +33-1-3420-8888
 Fax: +33-1-3420-8600
Product Information Center:
(Technical Support)
 Phone: +33-1-3420-8943
 Fax: +33-1-3420-8623

Germany – Bensheim
 Phone: +49-6251-133-0
 Fax: +49-6251-133-1600
Product Information Center:
(Technical Support)
 Phone: +49-6251-133-1999
 Fax: +49-6251-133-1988

Germany – Langen
 Phone: +49-6103-709-0
 Fax: +49-6103-709-1223

Germany – Speyer
 Phone: +49-6232-30-0
 Fax: +49-6232-30-2243

Germany - HTS Division – Neunkirchen
 Phone: +49-2247-305-0
 Fax: +49-2247-305-122

Great Britain –
 Stanmore Middlesex
 Phone: +44-8706-080-208
 Fax: +44-1793-572-109
Product Information Center:
(Technical Support)
 Freephone GB: 0800-267-666
 Phone: +44-208-420-8341 or 8343
 Fax: +44-208-420-8081

Great Britain – Raychem & Identification Products
 Phone: +44-1793-528171
 Fax: +44-1793-572-516

Greece – Athens
 Phone: +30-1-9370-396/397
 Fax: +30-1-9370-655

Hungary – Budapest
 Phone: +36-1-289-1000
 Fax: +36-1-289-1010

Ireland – Dublin
 Phone: +353-1-820-3000
 Fax: +353-1-820-9790

Israel – Yokneam
 Phone: +972-4-959-0508
 Fax: +972-4-959-0506

Italy – Collegno (Torino)
 Phone: +39-011-4012-111
 Fax: +39-011-4031116

Lithuania – Vilnius
 Phone: +370-5-2131-402
 Fax: +370-5-2131-403

Netherlands – 's-Hertogenbosch
 Phone: +31-73-624-62-46
 Fax: +31-73-621-23-65

Product Information Center:
(Technical Support)
 Phone: +31-73-6246-999
 Fax: +31-73-6246-998

Norway – Nesbru
 Phone: +47-66-77-8886
 Fax: +47-66-77-8855

Poland – Warsaw
 Phone: +48-22-45-76-700
 Fax: +48-22-45-76-720

Romania – Bucharest
 Phone: +40-21-311-3479/3596
 Fax: +40-21-312-0574

Russia – Moscow
 Phone: +7-095-926-5506/07/08/09
 Fax: +7-095-926-5505

Russia – St. Petersburg
 Phone: +7-812-718-8192
 Fax: +7-812-718-8193

Slovenia – Ljubljana
 Phone: +386-1561-3270
 Fax: +386-1561-3240

South Africa – Port Elizabeth
 Phone: +2741-503-4500
 Fax: +2741-581-0440

Spain – Barcelona
 Phone: +34-93-291-0330
 Fax: +34-93-201-7879
Product Information Center:
(Technical Support):
 Phone: +34-93-291-0330
 Fax: +34-93-200-3779

Sweden – Upplands Väsby
 Phone: +46-8-50-72-50-00
 Fax: +46-8-50-72-50-01



tyco

Electronics

Tyco Electronics Corporation
Harrisburg, Pennsylvania
www.tycoelectronics.com

a vital part of your world