

AXICOM

Telecom-, Signal and RF Relays

FX2 Relay

FX2 Relay

Disclaimer

While Tyco Electronics has made every reasonable effort to ensure the accuracy of the information in this datasheet, Tyco Electronics does not guarantee that it is error-free, nor does Tyco Electronics make any other representation, warranty or guarantee that the information is accurate, correct, reliable or current. Tyco Electronics reserves the right to make any adjustments to the information contained herein at any time without notice. Tyco Electronics expressly disclaims all implied warranties (and all express warranties, except as otherwise stated in this datasheet) regarding the information contained herein, including but not limited to any implied warranties or merchantability or fitness for a particular purpose. It is recommended that you test any new or replacement product before incorporating into a system.

The dimensions in this datasheet are for reference purpose only and are subject to change without notice. Specifications are subject to change without notice.



UL 508 File No. E 111441
UL 60950

IEC/EN60950

IEC Ref. Cert. No. CH-3269

Index

Dimensions	4
Coil Operating Range	5
Coil Data and Ordering Information	6
Contact Data	7
Insulation	8
General Data	8
Packing	9

FX2 Relay

2 pole telecom / signal relay
Through Hole Type (THT)
Polarized, latching or non-latching 1 coil

Relay types: sensitive non latching version with 1 coil
high sensitive non latching version with 1 coil, latching with 1 coil

ROHS compliant (Directive 2002/95/EC) as per product date code 0342.

Features

- Telecom/signal relay (dry circuit, test access, ringing)
- Slim line 15 x 7.3 mm, 0.590 x 0.287 inch
- Switching current 2 A
- 2 changeover contacts (2 form C / DPDT)
- Bifurcated contacts
- High sensitivity results in low nominal power consumption 80 mW for high sensitive, 140 mW for sensitive version
- High dielectric characteristic ≤ 1800 Vrms also between open contact
- High surge capability (1.2 / 50 μ s and 10 / 700 μ s) meets Telcordia GR 1089 and FCC Part 68 ≤ 2500 V between open contacts ≤ 3500 V between coil and contacts
- High mechanical shock up to 300 G functional up to 1500 G survival
- Hermetically sealed (RT V)

Typical applications

- Communications equipment linecard application - analog, ISDN, xDSL, PABX Voice over IP
- Office and business equipment
- Measurement and control equipment
- Consumer electronics Set top boxes, HiFi
- Medical equipment

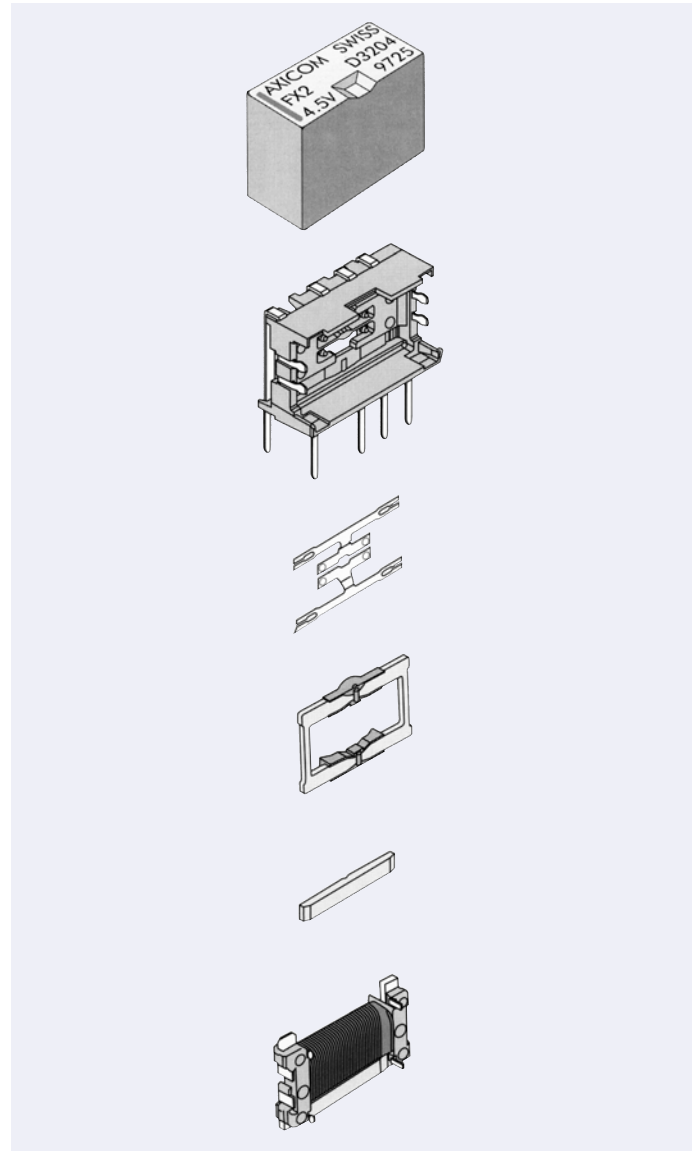

Insulation category

Supplementary insulation according	IEC / EN 60950
Working voltage	≤ 300 Vrms
Mains supply voltage	≤ 250 Vrms
Repetitive peak voltage	2500 V
Pollution degree	Internal: 1 External: 2
Flammability classification	V-0
Maximum operating temperature	85 °C

FX2 Relay

Dimensions

Dimensions in mm

THT		
	mm	inch
L	14.95 ± 0.05	0.588 ± 0.002
W	7.30 ± 0.05	0.287 ± 0.002
H	10.70 ± 0.05	0.421 ± 0.002
T	3.30 ± 0.30	0.129 ± 0.012
T1	N/A	N/A
T2	5.08 ± 0.15	0.199 ± 0.006
Tw	0.50	0.019
S	0.30 ± 0.05	0.012 ± 0.002

THT Version

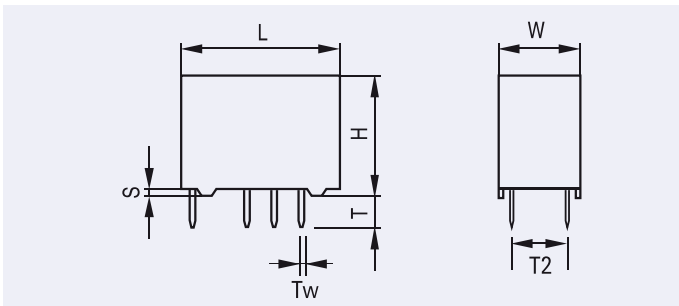

Mounting hole layout

View onto the component side of the PCB (top view)

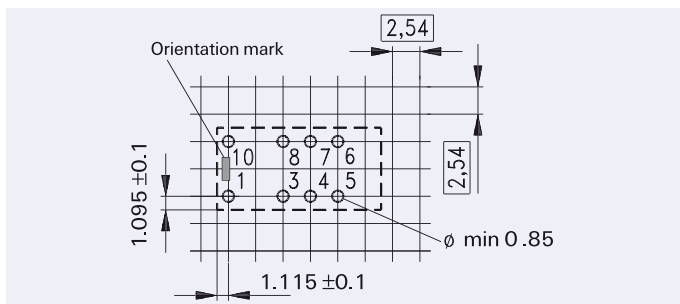

Terminal assignment

Relay – top view

Non-latching type

not energized condition

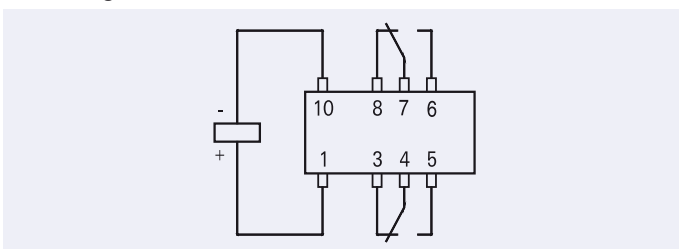

Latching type, 1 coil

reset condition

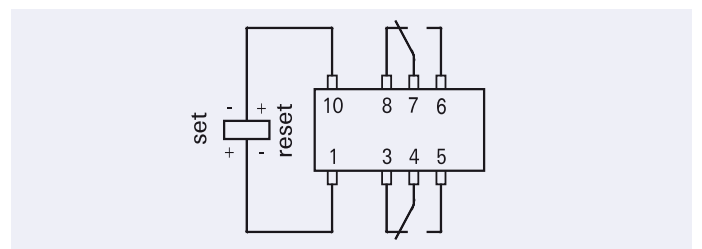

Contacts in reset position. Contact position might change during transportation and must be reset before use.

FX2 Relay

Coil Operating Range

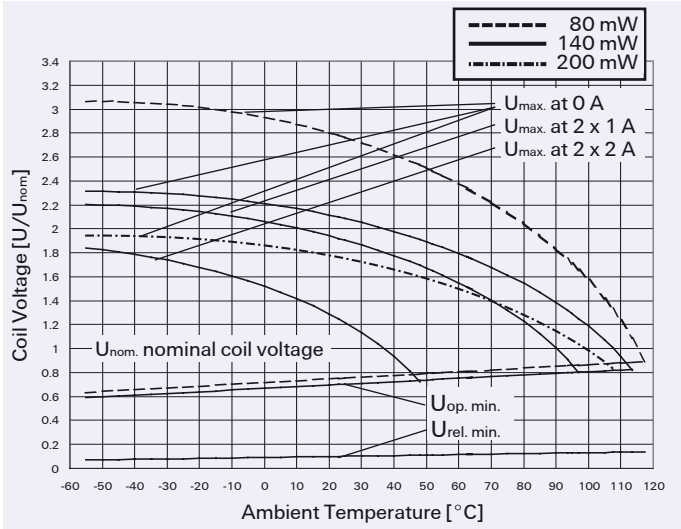

- U_{nom} = Nominal coil voltage
- U_{max}. = Upper limit of the operative range of the coil voltage (limiting voltage)
- U_{op. min.} = Lower limit of the operative range of the coil voltage (reliable operate voltage)
- U_{rel. min.} = Lower limit of the operative range of the coil voltage (reliable release voltage)

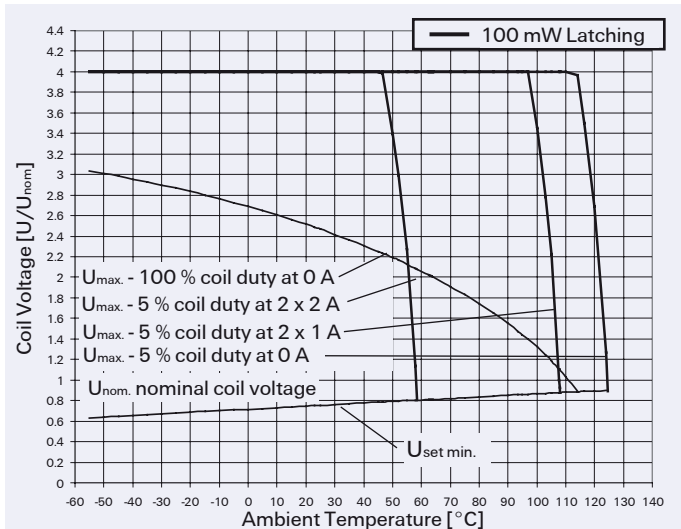
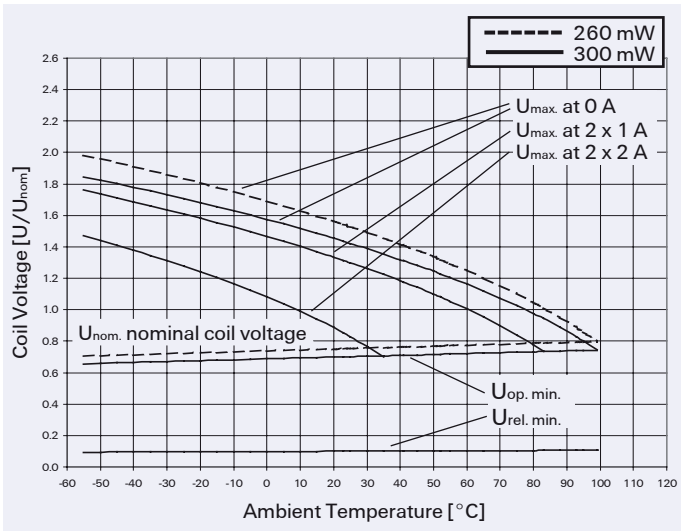

FX2 Relay

Coil Data (values at 23 °C)

Ordering Information

Nominal voltage Unom	Operate/set voltage range		Release/ reset voltage Minimum	Coil power	Coil Resistance	Relay code	Tyco part number
	Minimum voltage Umin	Maximum voltage Umax					
Vdc	Vdc	Vdc	Vdc	mW	Ω / ± 10 %		

Standard Version

Non-Latching, 1 coil

3	2.10	6.30	0.30	140	64	D 3206	1462034-6
4	2.80	8.40	0.40	140	114	D 3207	1462034-8
4.5	3.15	9.40	0.45	140	145	D 3204	1462034-2
5	3.50	10.50	0.50	140	178	D 3209	1462034-9
6	4.20	12.60	0.60	140	257	D 3205	1462034-5
9	6.30	18.90	0.90	140	574	D 3210	1-1462034-3
12	8.40	25.20	1.20	140	1028	D 3202	1462034-1
24	16.80	42.20	2.40	200	2880	D 3212	1-1462034-4
48	33.60	68.90	4.80	300	7680	D 3213	1-1462034-5

High Sensitive Version

Non-Latching, 1 coil

3	2.25	8.30	0.30	80	113	D 3221	1-1462034-9
4.5	3.38	11.10	0.45	80	353	D 3222	2-1462034-0
5	3.75	12.50	0.50	80	313	D 3223	2-1462034-1
6	4.50	13.90	0.60	80	450	D 3224	2-1462034-2
9	6.75	16.70	0.90	80	1013	D 3225	2-1462034-3
12	9.00	33.40	1.20	80	1800	D 3226	2-1462034-4
24	18.00	50.40	2.40	140	4114	D 3227	2-1462034-5
48	36.00	70.00	4.80	260	8882	D 3228	2-1462034-6

Standard Version

Latching, 1 coil

3	2.25	7.50	-2.25	100	90	D 3241	2-1462034-8
4.5	3.38	11.20	-3.38	100	203	D 3242	2-1462034-9
5	3.75	12.40	-3.75	100	250	D 3243	3-1462034-0
6	4.50	14.90	-4.50	100	360	D 3244	3-1462034-1
9	6.75	22.40	-6.75	100	810	D 3245	3-1462034-2
12	9.00	29.80	-9.00	100	1440	D 3246	3-1462034-3
24	18.00	48.70	-18.00	150	3840	D 3247	3-1462034-4

Further coil versions are available on request.

FX2 Relay

Contact Data

Number of contacts and type	2 changeover contacts
Contact assembly	Bifurcated contacts
Contact material	Palladium-ruthenium - gold covered
Limiting continuous current at max. ambient temperature	2 A
Maximum switching current	2 A
Maximum switching voltage	220 Vdc 250 Vac
Maximum switching capacity	60 W, 62.5 VA
Thermoelectric potential	< 10 μ V
Minimum switching voltage	100 μ V
Initial contact resistance / measuring condition: 10 mA / 20 mV	< 70 m Ω
Electrical endurance at contact application 0 (≤ 30 mV / ≤ 10 mA) at cable load open end at 24 V / 1.25 A at 125 V / 0.24 A at 30 V / 2 A	min. 2.5×10^6 operations min. 2.0×10^6 operations min. 5×10^5 operations min. 5×10^5 operations min. 5×10^5 operations
Mechanical endurance	typ. 10^8 operations
UL contact ratings	220 Vdc / 0.24 A - 60 W 125 Vdc / 0.24 A - 30 W 250 Vac / 0.25 A - 62.5 VA 125 Vac / 0.5 A - 62.5 VA 30 Vdc / 2 A - 60 W

Max. DC Load Breaking Capacity

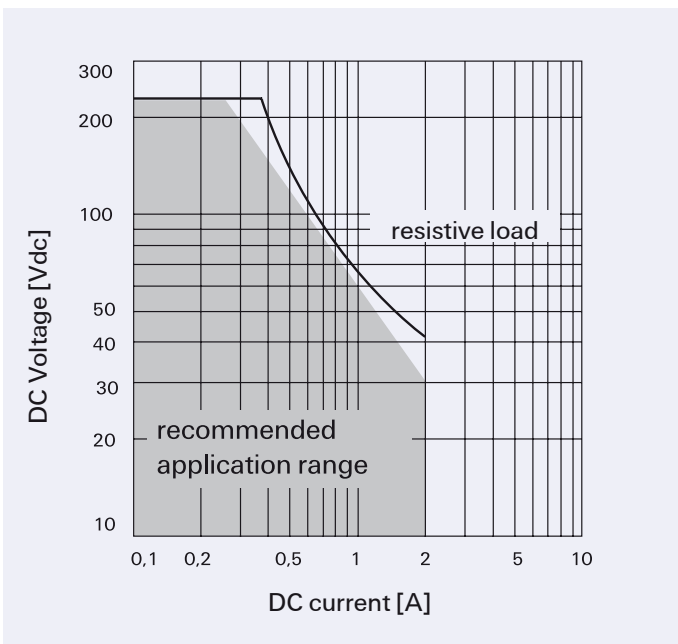

FX2 Relay

Insulation

Insulation resistance at 500 Vdc	> 10 ⁹ Ω
Dielectric test voltage (1 min)	
between coil and contacts	1800 Vrms
between adjacent contact sets	1800 Vrms
between open contacts	1800 Vrms
Surge voltage resistance	
according to Telcordia GR 1089 (2 / 10 μs)	
between coil and contacts	3500 V
between adjacent contact sets	2500 V
between open contacts	2500 V
according to FCC 68 (10 / 160 μs) and IEC (10 / 700 μs)	
between coil and contacts	3500 V
between adjacent contact sets	2500 V
between open contacts	2500 V

High Frequency Data

Capacitance	
between coil and contacts	max. 4 pF
between adjacent contact sets	max. 2 pF
between open contacts	max. 2 pF
RF Characteristics	
Isolation at 100 MHz / 900 MHz	- 34.0 dB / - 15.1 dB
Insertion loss at 100 MHz / 900 MHz	- 0.03 dB / - 0.60 dB
V.S.W.R. at 100 MHz / 900 MHz	1.07 / 1.45

General Data

Operate time at U _{nom} typ. / max.	3 ms / 4 ms
Reset time (latching) at U _{nom} , typ. / max.	3 ms / 4 ms
Duration of set / reset pulse (latching) min.	20ms*
Release time without diode in parallel (non-latching), typ. / max.	1 ms / 3 ms
Release time with diode in parallel (non-latching), typ. / max.	3 ms / 4 ms
Bounce time at closing contact, typ. / max.	1 ms / 5 ms
Maximum switching rate without load	50 operations/s
Ambient temperature	-55 °C ... +85 °C
Thermal resistance	< 165 K/W
Maximum permissible coil temperature	125 °C
Vibration resistance (function)	20 G 10 to 500 Hz
Shock resistance, half sinus, 11 ms	50 G (function) 1500 G (damage)
Degree of protection / Environmental protection	immersion cleanable, IP 67 / RT V
Needle flame test	application time 20 s, no burning
Mounting position	any
Processing information	Ultrasonic cleaning is not recommended
Weight (mass)	max. 2.5 g
Terminal surface	SnCu 0.7
Resistance to soldering heat	265 °C / 10 s

* Duration may be shorter depending on pulse shape, voltage applied and ambiente temperature

All data refers to 23 °C unless otherwise specified.

FX2 Relay

Packing

Dimensions in mm

Stick dimension

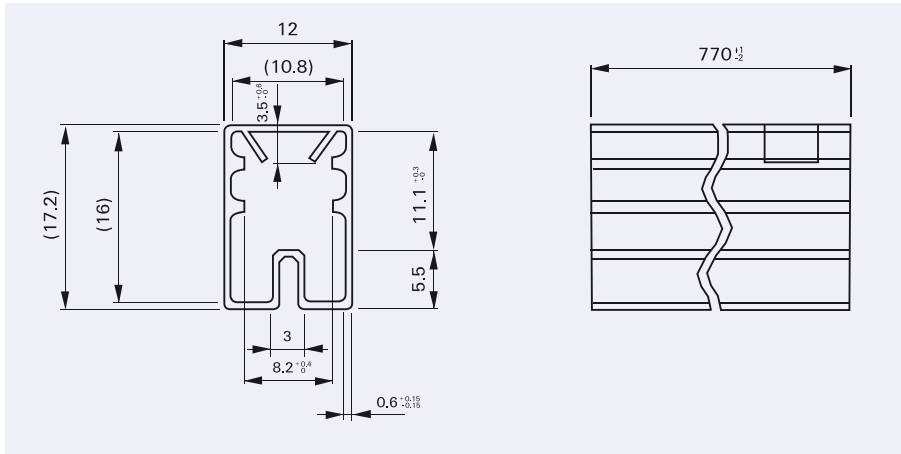

Tube for THT version
50 relays per stick
1'000 relays per box

FX2 Relay

IM Relays

4th generation slim line – low profile polarized 2 c/o telecom signal relay with bifurcated contacts, available as non latching or latching relay with 1 coil. Nominal voltage range from 1.5 ... 24 V, coil power consumption of 50 ... 200 mW, latching relays with 1 coil 100 mW. The IM relay is available as through hole and surface mount type (J-Legs and Gull Wings) and capable to switch loads up to 60 W/62,5 VA. It is currently the only 2 A rated 4G relay on the market. Dielectric strength fulfills the Telcordia requirements according GR 1089 (2,5 kV – 2 / 10 μ s) and FCC part 68 (1,5 kV – 10 / 160 μ s). The IM relay is tested according CECC/IECQ and certified in accordance with IEC/EN 60950 and UL 60950.

Dimensions approx. 10 x 6 mm board space and 5.65 mm height.

P2 Relays

3rd generation polarized 2 c/o telecom relay with bifurcated contacts, available as non latching or latching relay with 1 or 2 coils. Nominal voltage range from 3 ... 24 V, coil power consumption 140 mW, latching relays with 1 coil 70 mW. The P2 Relay is available as through hole or surface mount type and capable to switch currents up to 5 A. Dielectric strength fulfills the Telcordia requirements according GR 1089 (2,5 kV – 2 / 10 μ s) and FCC part 68 (1,5 kV – 10 / 160 μ s). The P2 relay is tested according CECC/IECQ and certified in accordance with IEC/EN 60950 and UL 60950. Dimensions approx. 15 x 7,5 mm board space and 10 mm height.

FX2 Relays

3rd generation polarized 2 c/o telecom relay with bifurcated contacts, available as non latching or latching relay with 1 coil. Nominal voltage range from 3 ... 48 V, coil power consumption of 80 ... 260 mW for the high sensitive version, 140... 300 mW for the standard version, latching relays with 1 coil 100 mW. The FX2 relay is available as through hole type and capable to switch loads up to 60 W/62,5 VA. Dielectric strength fulfills the Telcordia requirements according GR 1089 (2,5 kV – 2 / 10 μ s) and FCC part 68 (1,5 kV – 10 / 160 μ s). The FX2 relay is tested according CECC/IECQ and certified in accordance with IEC/EN 60950 and UL 60950. Dimensions approx. 15 x 7,5 mm board space and 10,7 mm height.

FT2 / FU2 Relays

3rd generation non polarized, non latching 2 c/o telecom relay with bifurcated contacts. Nominal voltage range from 3 ... 48 V, coil power consumption 200 ... 300 mW. Most sensitive 48 V relay. Available as through hole and surface mount type. Dielectric strength fulfills the Telcordia requirements according GR 1089 (2,5 kV – 2 / 10 μ s) and FCC part 68 (1,5 kV – 10 / 160 μ s). The FT2/FU2 relay is tested according CECC/IECQ and certified in accordance with IEC/EN 60950 and UL 60950.

Dimensions approx. 15 x 7,5 mm board space and 10 mm height.

FP2 Relays

3rd generation polarized 2 c/o telecom relay with bifurcated contacts, available as non latching or latching relay with 1 or 2 coils. Nominal voltage range from 3 ... 48 V, coil power consumption of 80 ... 260 mW for the high sensitive version, 140... 300 mW for the standard version, latching relays with 1 coil 100 mW. The FP2 Relay is available as through hole type and capable to switch loads up to 60 W/62,5 VA. Dielectric strength fulfills FCC part 68 (1,5 kV – 10 / 160 μ s). The FP2 is tested according CECC/IECQ approved.

Dimensions approx. 14 x 9 mm board space and 5 mm height.

MT2

2nd generation non polarized, non latching 2 c/o telecom and signal relay with bifurcated contacts. Nominal voltage range from 3 ... 48 V, coil power consumption 150/200/300/400 and 550 mW. Dielectric strength fulfills the requirements according FCC part 68 (1,5 kV – 10 / 160 μ s).

Dimensions approx. 20 x 10 mm board space and 11 mm height.

D2n Relays

2nd generation non polarized 2 c/o relay for telecom and various other applications. Nominal voltage range from 3 ... 48 V, coil power consumption from 150 ... 500 mW. The D2n relay is capable to switch currents up to 3 A. Dielectric strength fulfills the requirements according FCC part 68 (1,5 kV – 10 / 160 μ s). Dimensions approx. 20 x10 mm board space and 11 mm height.

P1 Relays

Extremely sensitive, polarized 1 c/o relay with bifurcated contacts for a wide range of applications, available as non latching or latching relay with 1 or 2 coils. Nominal voltage range from 3 ... 24 V, coil power consumption 65 mW, latching relays with 1 coil 30 mW. The P1 relay is available as through hole or surface mount type and capable to switch currents up to 1 A. Dielectric strength fulfills the requirements according FCC part 68 (1,5 kV – 10 / 160 μ s). Dimensions approx. 13 x 7,6 mm board space and 7 mm height for THT or 8 mm height for SMT version.

W11 Relays

Low cost, non polarized 1 c/o relay for various applications. Nominal voltage range from 3 ... 24 V, coil power consumption 450 mW, sensitive versions 200 mW. The W11 relay is capable to switch currents up to 3 A. Dielectric strength 1000 Vrms.

Dimensions approx. 15,6 x 10,6 mm board space and 11,5 mm height.

Reed Relays

High sensitive, non polarized relay for telecom and various other applications, available with 1 n/o, 2 n/o or 1c/o contacts. Nominal voltage range from 5 ... 24 V, coil power consumption 50...280 mW for 1 n/o and 125 ... 280 mW for 2 n/o or 1 c/o versions. Reedrelays are available in DIP or SIL housing and capable to switch currents up to 0,5 A. Integrated diode and/or electrostatic shield optional. Dielectric strength 1500 Vdc. Dimensions approx. 19,3 x 7 mm board space and 5 ... 7,5 mm height for DIP or 19,8 x 5 mm board space and 7,8 mm height for SIL version.

Cradle Relays

Extremely reliable and mature relay family of 1st generation for various signal switching applications. Available as non polarized, polarized / latching and relay with AC coil. The benefit is the possibility of combining various contact sets from 1 up to 6 poles, single and bifurcated contacts, different contact materials with a coil voltage range from 1,5 Vdc to 220 Vac. Cradle relays are available as dust protected and hermetically sealed versions, with plug in or solder terminals and are capable to switch currents up to 5 A. Forcibly guided (linked) contact sets optional. Dielectric strength 500 Vrms. Dimensions from approx. 19 x 24 to 19x35 mm board space and 30 mm height.

Other Relays

We offer a variety of different relay families for maintenance and replacement purposes. These relays are up to 60 years old now, such as Card Relay SN (V23030 series), Small General Purpose Relay (V23006 series), Small Polarized Relay (V23063 ... V23067 and V23163 ... V23167 series). Accessories like sockets, hold down springs, etc. optional.

High Frequency Relays

HF3 / HF3S / HF6 series RF relays offering excellent RF characteristics in a small package. All HF series relays are suitable for SMD soldering processes. Available as non latching or latching versions with 1 or 2 coils and a nominal coil voltage range from 3 ... 24 V, a coil power consumption of 140 mW or 70 mW (single coil latching types).

HF3: Low cost RF relay suitable up to 3 GHz. Impedance 50 and 75 Ohm. 50 W hot switching and 50 W RF power carry capability. Dimensions 14.6 x 7.3 x 10.3 mm.

HF3S: High performance, high power RF relay suitable up to 3 GHz, 50 W hot switching and 150 W RF power carry capability. Dimensions 15 x 7.6 x 10.6 mm.

HF6: High performance, high power RF relay suitable up to 6 GHz, 50 W hot switching and 50 W RF power carry capability. Dimensions 15 x 7.6 x 10.6 mm.



Tyco Electronics Logistics AG
Werk Axicom Au
Seestrasse 295
CH-8804 Au-Wädenswil / Switzerland
Phone +41 44 782 91 11
Fax +41 44 782 90 00
E-mail: axicom@tycoelectronics.com



Tyco Electronics
Paulsternstrasse 26
D-13629 Berlin / Germany
Phone +49 30 386 38573
Fax +49 30 386 38575
E-mail: axicom@tycoelectronics.com



Tyco Electronics EC Trutnov s.r.o.
Komenského 821
CZ-541 01 Trutnov / Czech Republic
E-mail: axicom@tycoelectronics.com

AXICOM

Telecom-, Signal and RF Relays

Tyco Electronics Corporation
POB 3608,
Harrisburg, PA 17105, USA
Phone +1 800-522-6752

 **Tyco Electronics**

Our commitment. Your advantage.