

**tyco**

Electronics

## BCF Series

Very compact  
3-Phase Filter Series  
for universal application

*Sehr kompakter Dreiphasenfilter  
für den universellen Einsatz*

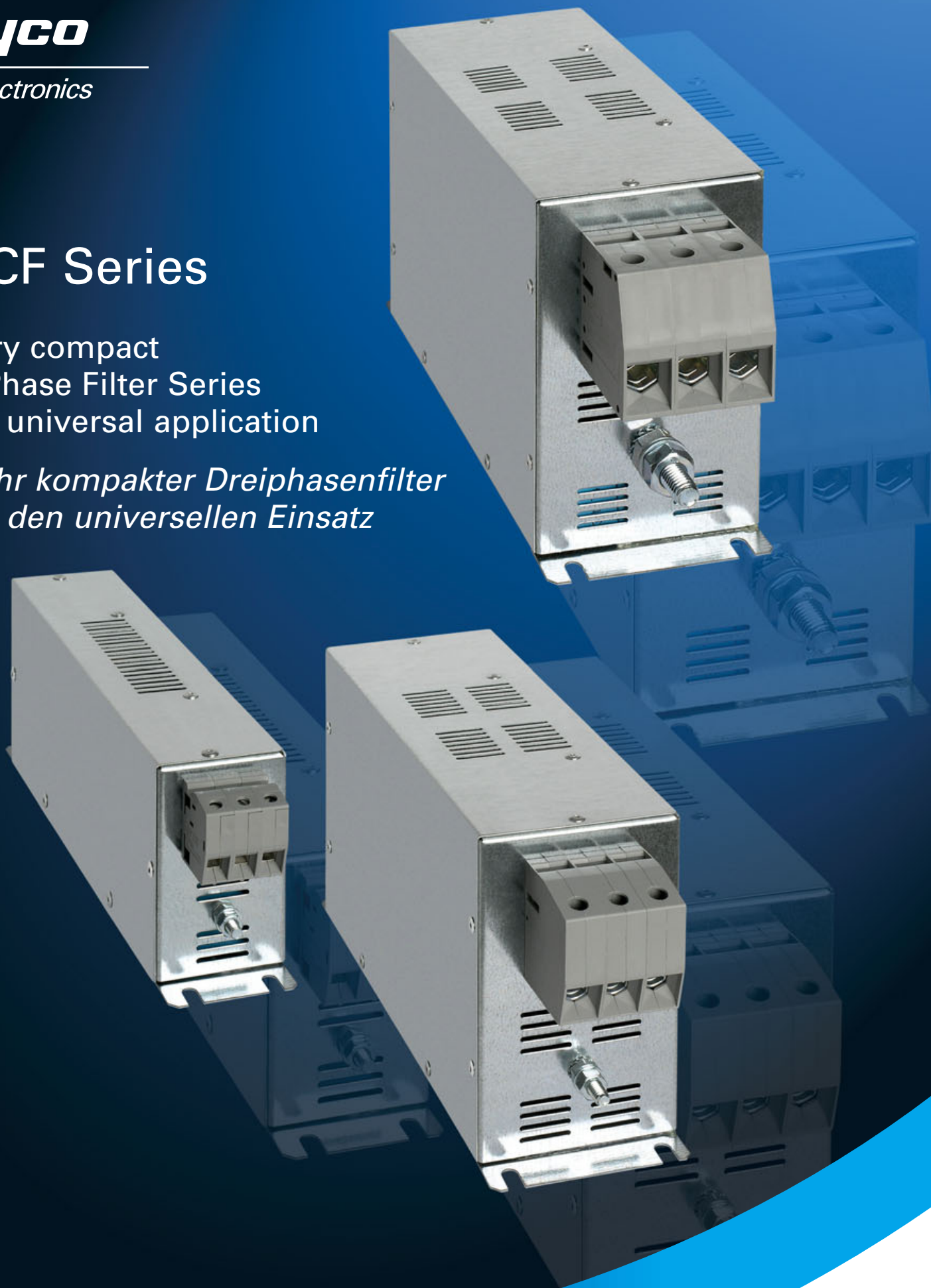

**corcom**

**General Information / Allgemeine Informationen**

- Very compact bookform filter
  - Low weight design
  - Insulated, high quality safety terminals for in- and output
  - For current rating up to 180 A
  - Cost effective design
  - Ideal for all kinds of industrial 3-phase applications requiring very high attenuation in the frequency range between 100 KHz and 30 MHz
  - Very high common and differential mode performance over the whole frequency range
- *Sehr kompakter Buchform-Filter*
  - *Geringes Gewicht*
  - *Isolierte, hoch qualitative Sicherheitsklemmen auf der Ein- und Ausgangsseite*
  - *Für Stromstärken bis zu 180 A*
  - *Kostenoptimiertes Design*
  - *Hervorragend geeignet für alle industriellen 3-Phasen-Anwendungen, die eine sehr hohe Einfügungsdämpfung im Frequenzbereich zwischen 100 KHz und 30 MHz benötigen*
  - *Sehr hohe asymmetrische und symmetrische Dämpfung über den gesamten Frequenzbereich*

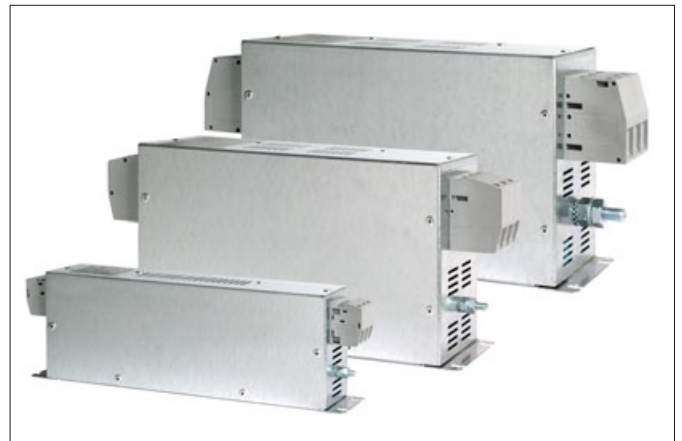

RoHS  
Ready



**Electrical Schematic / Elektrischer Schaltplan**

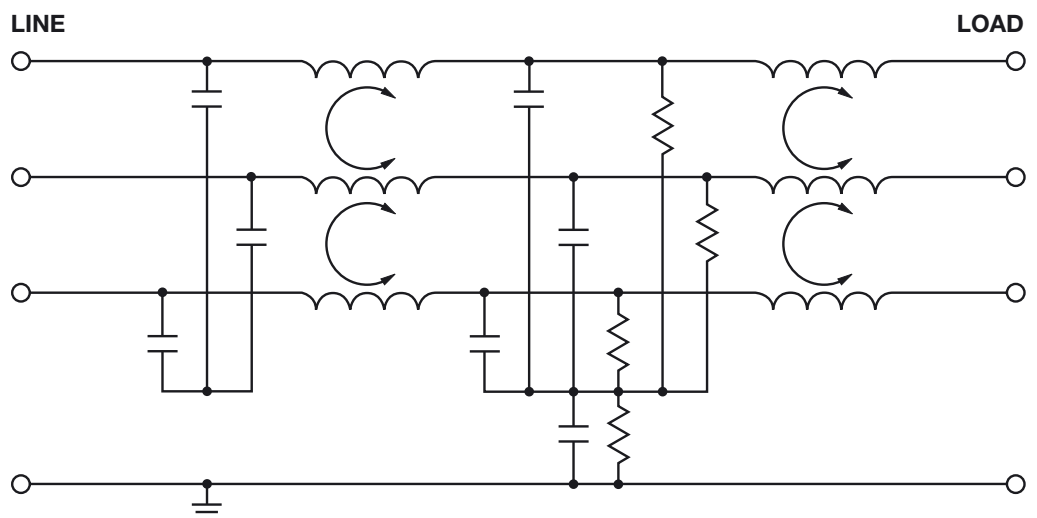

## Electrical Specifications / Elektrische Eigenschaften

**Maximum leakage current / Maximaler Ableitstrom:**

@ 400 VAC 50 Hz: 30 mA under normal circumstances  
(if 2 phases are interrupted, this leakage may rise to a significant higher level)

**Hipot rating (one minute) / Prüfspannung (1 Minute):**

line-to-ground 1850 VDC  
line-to-line 1850 VDC

**Operating frequency / Nennfrequenz:**

DC to 60 Hz

**Rated voltage (max.) / Nennspannung (max.):**

480 VAC

## Ordering Information / Bestellinformationen



| Type     | Order no. | Max. Current<br>50 °C / 40 °C | Inductance<br>L | C <sub>x</sub> | C <sub>y</sub> |
|----------|-----------|-------------------------------|-----------------|----------------|----------------|
| 7BCF10   | 1609989-1 | 7 A / 8 A                     | 2,44 mH         | 3,3 µF         | 2,0 µF         |
| 16BCF10  | 1609989-2 | 16 A / 18 A                   | 2,32 mH         | 3,3 µF         | 2,0 µF         |
| 30BCF10  | 1609989-3 | 30 A / 33 A                   | 1,61 mH         | 5,0 µF         | 2,1 µF         |
| 42BCF10  | 1609989-4 | 42 A / 46 A                   | 1,14 mH         | 6,7 µF         | 2,2 µF         |
| 55BCF10  | 1609989-5 | 55 A / 61 A                   | 1,80 mH         | 6,7 µF         | 2,2 µF         |
| 75BCF10  | 1609989-6 | 75 A / 83 A                   | 1,08 mH         | 6,7 µF         | 2,2 µF         |
| 100BCF10 | 1609989-7 | 100 A / 110 A                 | 0,82 mH         | 6,7 µF         | 2,2 µF         |
| 130BCF10 | 1609989-8 | 130 A / 143 A                 | 0,56 mH         | 6,7 µF         | 2,2 µF         |
| 180BCF10 | 1609989-9 | 180 A / 198 A                 | 0,72 mH         | 6,7 µF         | 2,2 µF         |

**Mechanical Data / Mechanische Eigenschaften**

Bottom view

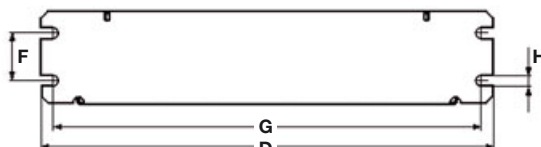

Side view

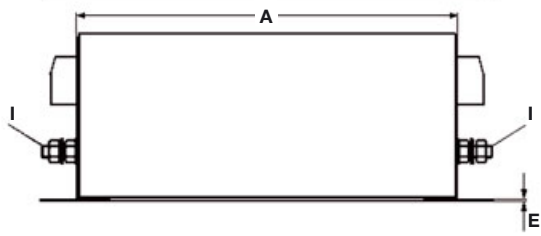

Front view

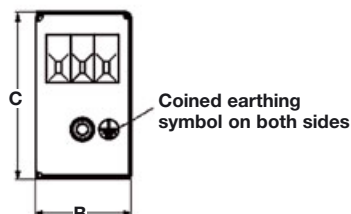

Top view

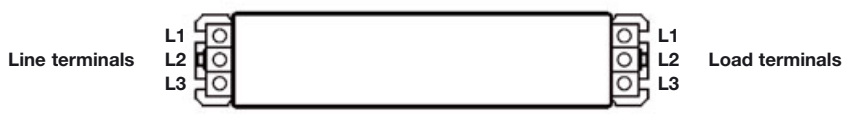

| Type     | A   | B   | C   | D   | E   | F   | G   | H   | GND (I) | Type of connection                | Weight (kg) | Packing unit |
|----------|-----|-----|-----|-----|-----|-----|-----|-----|---------|-----------------------------------|-------------|--------------|
| 7BCF10   | 160 | 40  | 70  | 190 | 0,8 | 20  | 180 | 4,5 | M5      | Terminal block 4 mm <sup>2</sup>  | 0,7         | 1            |
| 16BCF10  | 220 | 45  | 70  | 250 | 0,8 | 25  | 235 | 5,4 | M5      | Terminal block 4 mm <sup>2</sup>  | 1,1         | 1            |
| 30BCF10  | 240 | 50  | 85  | 270 | 0,8 | 30  | 255 | 5,4 | M5      | Terminal block 10 mm <sup>2</sup> | 1,5         | 1            |
| 42BCF10  | 280 | 50  | 85  | 310 | 0,8 | 30  | 295 | 5,4 | M6      | Terminal block 10 mm <sup>2</sup> | 1,7         | 1            |
| 55BCF10  | 220 | 85  | 90  | 250 | 1,0 | 60  | 235 | 5,4 | M6      | Terminal block 16 mm <sup>2</sup> | 2,4         | 1            |
| 75BCF10  | 240 | 80  | 135 | 270 | 1,0 | 60  | 255 | 6,5 | M6      | Terminal block 25 mm <sup>2</sup> | 3,2         | 1            |
| 100BCF10 | 240 | 90  | 150 | 270 | 1,0 | 65  | 255 | 6,5 | M10     | Terminal block 50 mm <sup>2</sup> | 4,2         | 1            |
| 130BCF10 | 240 | 90  | 150 | 270 | 1,0 | 65  | 255 | 6,5 | M10     | Terminal block 50 mm <sup>2</sup> | 4,4         | 1            |
| 180BCF10 | 350 | 120 | 170 | 380 | 1,0 | 102 | 365 | 6,5 | M10     | Terminal block 95 mm <sup>2</sup> | 6,2         | 1            |

All dimensions in mm

**Typical Insertion Loss / Beispiel typischer Einfügungsdämpfung**

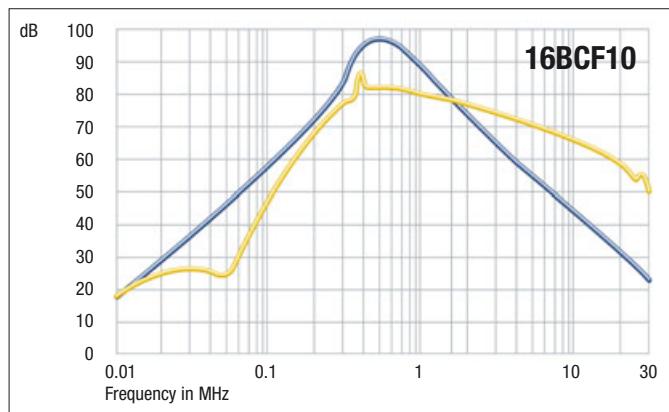
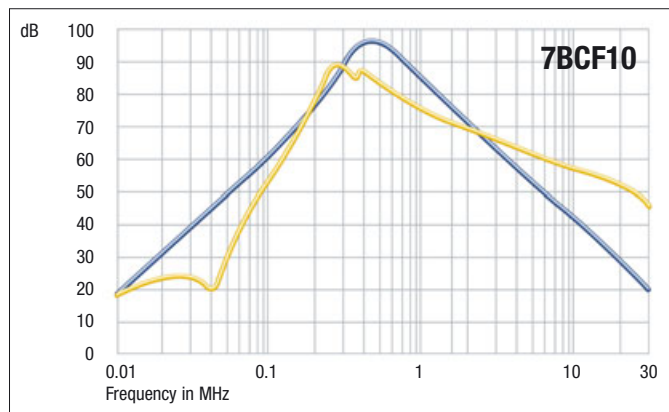

to be continued on next page/Fortsetzung auf folgender Seite

**Typical Insertion Loss / Beispiel typischer Einfügungsdämpfung**

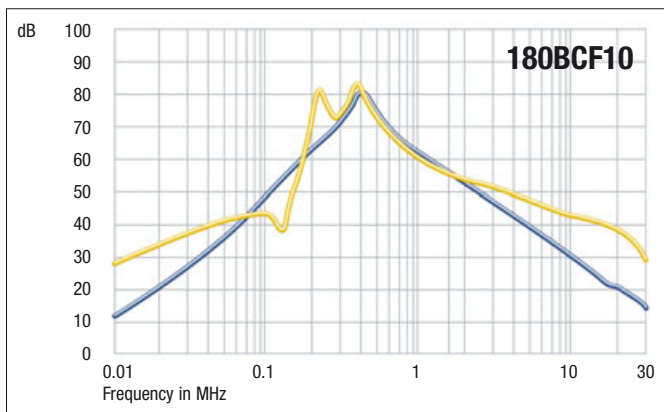
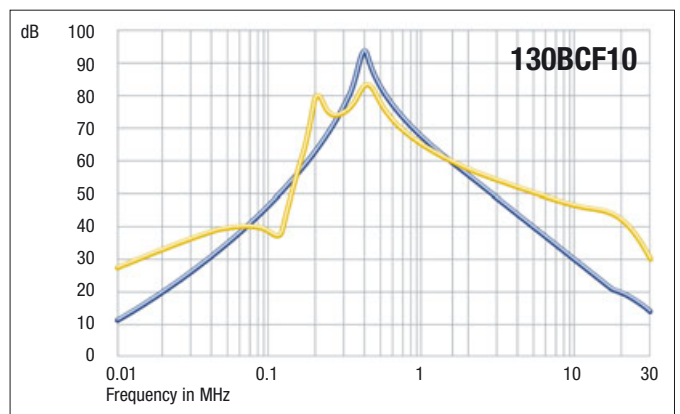
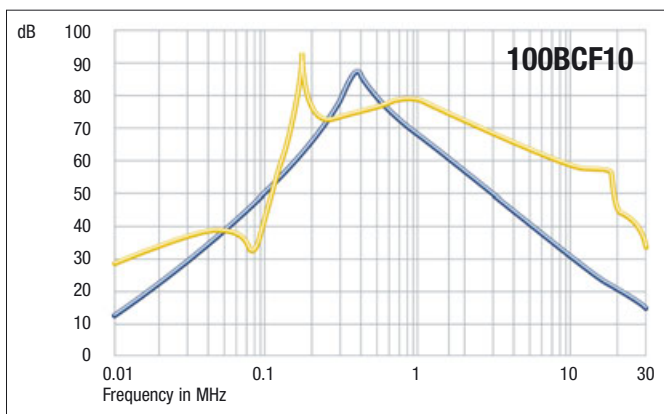
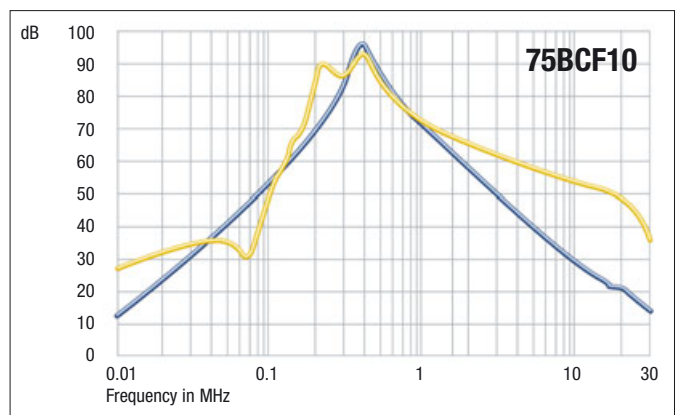
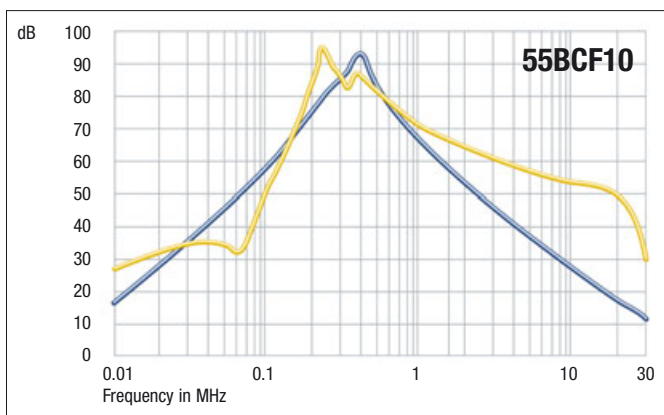
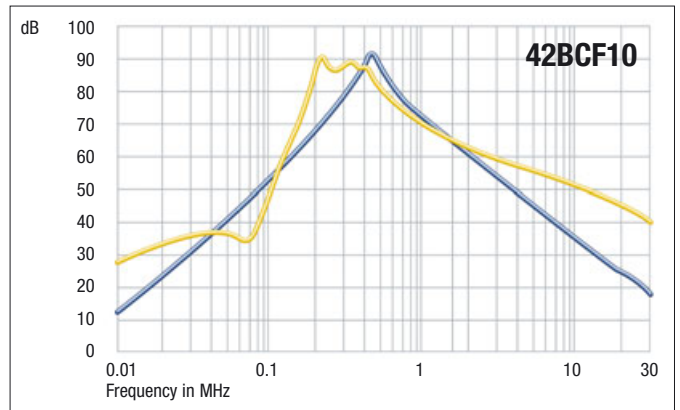
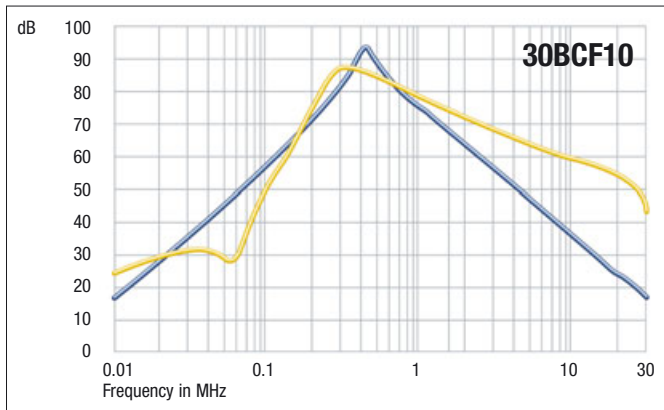

— sym.  
— asym.

Measuring method: closed 50 Ω system



**Austria** – Vienna

Phone: +43-1-905-60-0  
Fax: +43-1-905-60-1333  
**Product Information Center:**  
Phone: +43-1-905-60-1249  
Fax: +43-1-905-60-1251

**Belgium** – Kessel-Lo

Phone: +32-16-352-300  
Fax: +32-16-352-352

**Bulgaria** – Sofia

Phone: +359-2-971-2152  
Fax: +359-2-971-2153

**Czech Republic** – Kurim

Phone: +420-5-41-162-111  
Fax: +420-5-41-162-223  
**Product Information Center:**  
Phone: +420-5-41-162-113  
Fax: +420-5-41-162-132

**Denmark** – Glostrup

Phone: +45-43-480-452  
Fax: +45-43-441-414

**Egypt** – Cairo

Phone: +20-2-417-76-47  
Fax: +20-2-419-23-34

**Finland** – Helsinki

Phone: +358-95-12-34-20  
Fax: +358-95-12-34-250

**France** – Cergy-Pontoise Cedex

Phone: +33-1-3420-8888  
Fax: +33-1-3420-8600  
**Product Information Center:**  
Phone: +33-1-3420-8686  
Fax: +33-1-3420-8623

**France Export Divisions** –

Cergy-Pontoise Cedex  
Phone: +33-1-3420-8866  
Fax: +33-1-3420-8300

**Germany** – Bensheim

**Tyco Electronics AMP GmbH**  
Phone: +49-6251-133-0  
Fax: +49-6251-133-1600  
**Product Information Center:**  
Phone: +49-6251-133-1999  
Fax: +49-6251-133-1988

**Germany** – Langen

**Tyco Electronics AMP GmbH**  
Phone: +49-6103-709-0  
Fax: +49-6103-709-1223

**Germany** – Niefem

**Tyco Electronics pretema GmbH & Co. KG**  
Phone: +49-7233-69-0  
Fax: +49-7233-69-100

**Germany** – Ottobrunn

**Tyco Electronics Raychem GmbH**  
Phone: +49-89-6089-0  
Fax: +49-89-6096-345

**Great Britain** –

Stanmore Middlesex  
Phone: +44-8706-080-208  
Fax: +44-208-954-6234  
**Product Information Center:**  
Freephone GB: 0800-267-666  
Phone: +44-208-420-8341  
+44-208-420-8343  
Fax: +44-208-420-8081

**Greece** – Athens

Phone: +30-210-9370-396/397  
Fax: +30-210-9370-655

**Hungary** – Budapest

Phone: +36-1-289-1000  
Fax: +36-1-289-1010  
**Product Information Center:**  
Phone: +36-1-289-1016  
Fax: +36-1-289-1017

**Ireland** – Dublin

Phone: +353-1-820-3000  
Fax: +353-1-820-9790

**Israel** – Yokneam

Phone: +972-4-959-0508  
Fax: +972-4-959-0506

**Italy** – Collegno (Torino)

Phone: +39-011-4012-111  
Fax: +39-011-4031116  
**Product Information Center:**  
Phone: +39-011-4012-360  
Fax: +39-011-40287360

**Lithuania** – Vilnius

Phone: +370-5-2131-402  
Fax: +370-5-2131-403

**Netherlands** – 's-Hertogenbosch

Phone: +31-73-6246-246  
Fax: +31-73-6212-365  
**Product Information Center:**  
Phone: +31-73-6246-999  
Fax: +31-73-6246-998

**Norway** – Nesbru

Phone: +47-66-77-88-86  
Fax: +47-66-77-88-55

**Poland** – Warsaw

Phone: +48-22-4576-700  
Fax: +48-22-4576-720  
**Product Information Center:**  
Phone: +48-22-4576-704  
Fax: +48-22-4576-720

**Romania** – Bucharest

Phone: +40-21-311-3479 + 3596  
Fax: +40-21-312-0574

**Russia** – Moscow

Phone: +7-095-926-55-06...09  
Fax: +7-095-926-55-05

**Russia** – St. Petersburg

Phone: +7-812-718-8192  
Fax: +7-812-718-8193

**Slovenia** – Ljubljana

Phone: +386-1561-3270  
Fax: +386-1561-3240

**South Africa** – Port Elizabeth

Phone: +2741-503-4500  
Fax: +2741-581-0440

**Spain** – Barcelona

Phone: +34-93-291-0330  
Fax: +34-93-201-7879

**Sweden** – Upplands Väsby

Phone: +46-8-50-72-50-00  
Fax: +46-8-50-72-50-01

**Switzerland** – Steinach

Phone: +41-71-447-0447  
Fax: +41-71-447-0444

**Turkey** – Istanbul

Phone: +90-212-281-8181...3  
+90-212-282-5130/5430  
Fax: +90-212-281-8184

**Ukraine** – Kiev

Phone: +380-44-206-2265  
Fax: +380-44-206-2264