

Glass-Epoxy Receptacles with .88 [22.35] Barrel Depth

**Flanged, for Hermetic Seal
Part Number 861254-1**

Weight — 5 grams

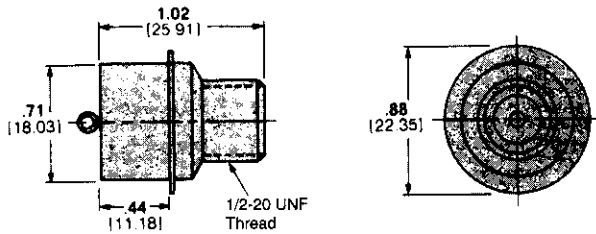

These receptacles are for use with RFI Shielded Lead Assemblies shown on the preceding page.

**Molded Receptacle
Part Number 850306-3**

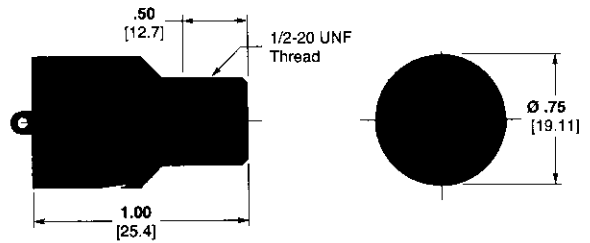

**For Encapsulated Units
Part Number 834333-2**

Weight — 4 grams

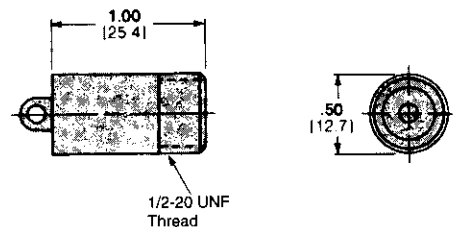

**Bulkhead Receptacle
Part Number 449690-1**

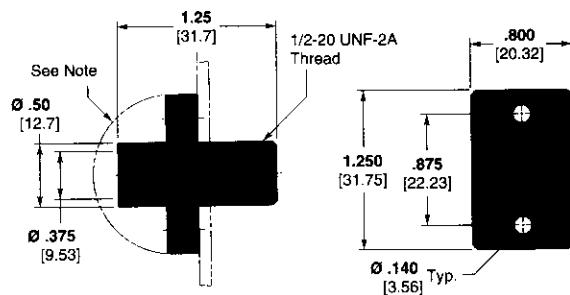

Note: Customer must protect back end against arc-over and breakdown if bulkhead and mounting hardware are metallic and at ground potential.

**Special Receptacle
Part Number 448463-1**

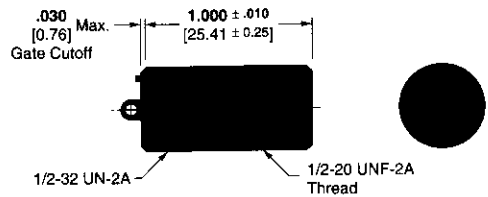

**Flanged, Bolt Mount
Part Number 858827-1**

Weight — 16 grams

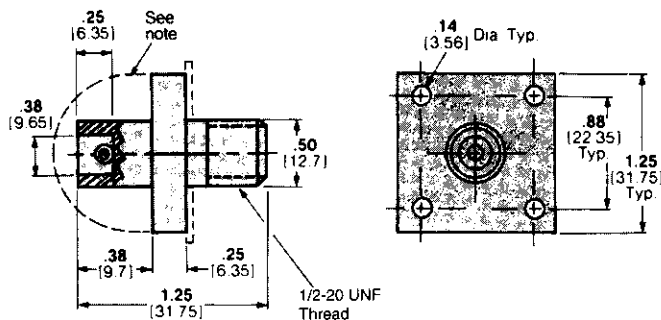

Note: If the panel or mounting hardware is at ground potential, guard against arc-over and breakdown within the area defined by this line.

**With Recessed Terminal for
Encapsulated Units
Part Number 849610-3**

Weight — 5 grams

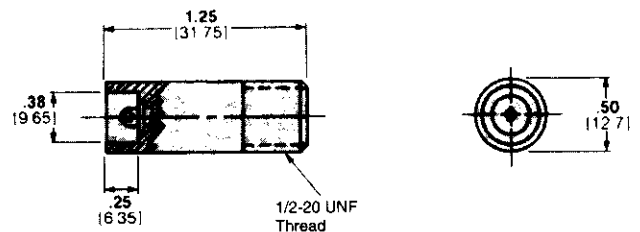

Receptacles are available with gold plated contacts.