

**PLASTI-GRIP\* Terminals and Splices**
**NOTE**

All numerical values are in metric units [with U.S. customary units in brackets]. Dimensions are in millimeters [and inches]. Unless otherwise specified, dimensions have a tolerance of  $\pm 0.13$  [ $\pm .005$ ] and angles have a tolerance of  $\pm 2^\circ$ . Figures and illustrations are for identification only and are not drawn to scale.

**1. INTRODUCTION**

This specification covers the requirements for application of PLASTI-GRIP terminals and splices for commercial applications. The terminals and splices consist of precision formed metal wire barrel insulated with vinyl with a maximum operating temperature of  $90^\circ\text{C}$  [ $194^\circ\text{F}$ ] for the splices and  $105^\circ\text{C}$  [ $221^\circ\text{F}$ ] for the terminals. The ring tongue terminals and butt splices are also available insulated with PVF<sup>2</sup> (polyvinylidene fluoride); these terminals and splices can withstand a temperature range of  $-65$  to  $150^\circ\text{C}$  [ $149$  to  $302^\circ\text{F}$ ]. The terminals are also available in heavy duty (HD) for extra mechanical strength. The terminals and splices accept solid or stranded wire for single applications. The flared end of the insulation allows insertion of wires that meet maximum voltage ratings: 600 V for building wiring and 1,000 V for fixture and sign wiring.

The terminals and splices are color coded to provide a visual reference applicable to the wire size range suitable for the terminal or splice. In addition, terminals are marked on the tongue with the wire size range. The serrations or dimples inside the wire barrel provide maximum contact and tensile strength after crimping. The terminals suitable for mounting accept stud sizes M2 [2] through M12 [.50] (a diameter range of 2.18 through 12.7 [.086 through .500]). The terminals and splices are available in loose-piece for terminating with manual and pneumatically-powered hand-held tools, and in tape-mounted form for terminating with semi-automatic hand-held tools and electrically-powered machines.

When corresponding with Tyco Electronics Personnel, use the terminology provided in this specification to facilitate your inquiries for information. Basic terms and features of this product are provided in Figure 1.

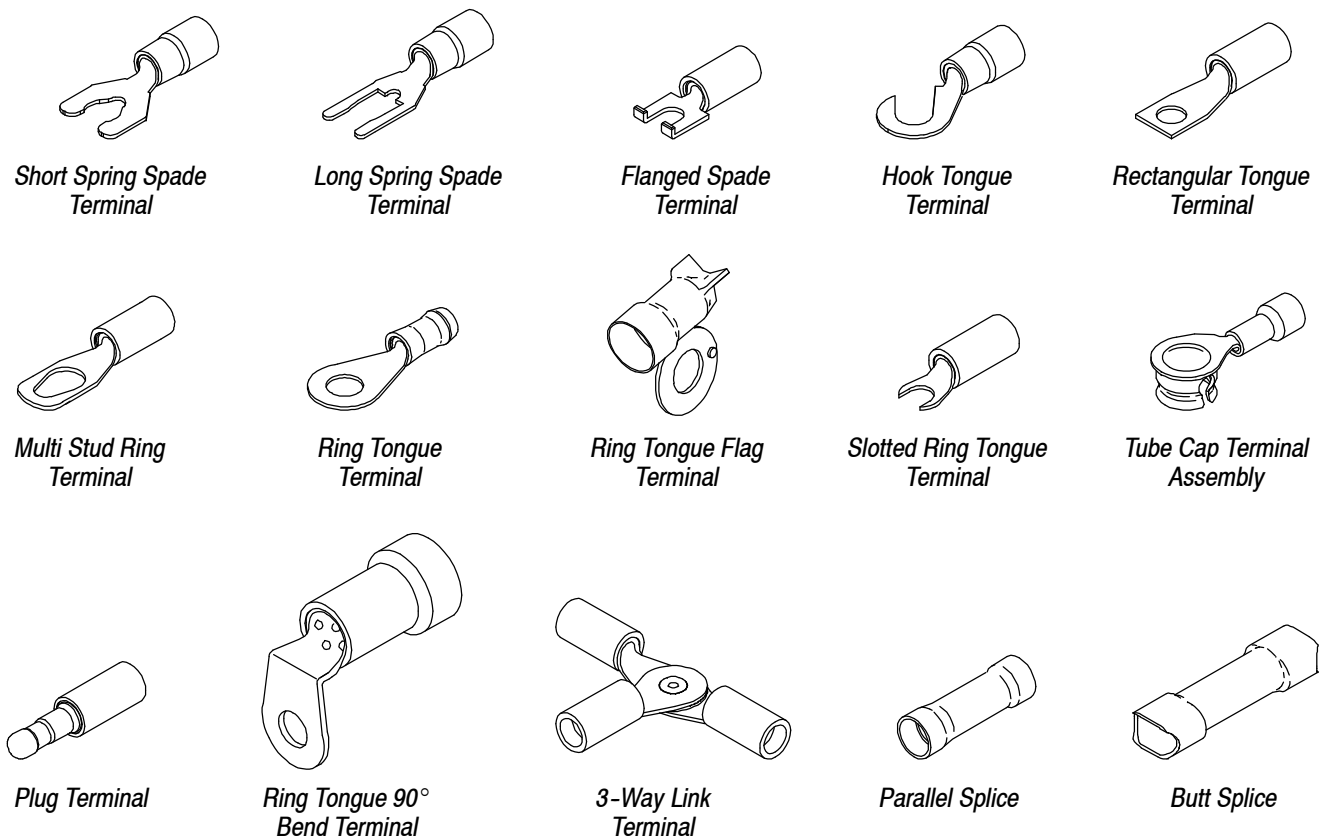

Figure 1

## 2. REFERENCE MATERIAL

### 2.1. Revision Summary

Revisions to this application specification include:

- Removed Crimping Die Assembly 1213098-1

### 2.2. Customer Assistance

Reference Product Base Part Number 32945 and Product Code 3040 are representative of PLASTI-GRIP terminals and splices. Use of these numbers will identify the product line and expedite your inquiries through a service network established to help you obtain product and tooling information. Such information can be obtained through a local Tyco Electronics Representative or, after purchase, by calling Product Information at the number at the bottom of page 1.

### 2.3. Drawings

Customer Drawings for product part numbers are available from the service network. If there is a conflict between the information contained in the Customer Drawings and this specification or with any other technical documentation supplied, call Product Information at the number at the bottom of page 1.

### 2.4. Instructional Material

Instruction Sheets (408-series) provide product assembly instructions or tooling setup and operation procedures and Customer Manuals (409-series) provide machine setup and operation procedures. Documents available which pertain to this product are:

#### A. Product

- 408-7424 Checking Terminal Crimp Height or Gaging Die Closure
- 408-9816 Handling of Reeled Products

#### B. Tooling

- 408-1256 Hand Crimping Tool 59270
- 408-1261 Hand Crimping Tool 59239-4
- 408-1263 Hand Crimping Tools 59489 and 59287-1
- 408-1310 Pneumatic Tool 69015
- 408-1502 Hand Crimping Tools 45160 and 45575-1
- 408-1548 Hand Crimping Tools 45449 and 45450
- 408-1559 Hand Crimping Tools 46121, 47386, and 47387
- 408-1570 Hand Crimping Tools 48040 and 48049
- 408-1610 "T"-HEAD\* Crimping Tools 59250 and 59170
- 408-1632 Crimping Dies 47806-2, 47807-1, and 47808-6
- 408-1724 Crimping Dies 48858-1, 48859-1, 48861-1, and 47238-1
- 408-1729 Crimping Dies 47820, 47821, 47822, and 47823
- 408-1758 Crimping Dies 48752-1, 48753-1, 48754-1, and 48755-1
- 408-2095 Hand Crimping Tool 69710-1
- 408-2423 Crimping Die Assemblies 69877, 69878, 69872, 69873, and 68116-1
- 408-2434 Hand Crimping Tool 69959
- 408-2450 Hydraulic Crimping Head 69051
- 408-2453 Hydraulic Crimping Head 69066
- 408-2498 Crimping Head Cross-Reference for Pneumatic Tools
- 408-2567 Tool and Die Selection Chart
- 408-2575 Tool and Die Selection Chart for AMP\* Terminals and Splices
- 408-2592 Crimping Die Assemblies 68247-1 and 68248-1
- 408-2667 Crimping Die Assembly 69893
- 408-2822 Crimping Die Assemblies 59826-1, 59827-1, 59828-1, and 69874
- 408-2823 TETRA-CRIMP\* Hand Crimping Tool 59824-1
- 408-4071 Pneumatic Crimping Head 679300-1
- 408-4099 Pneumatic TETRA-CRIMP Adapter 679305-1

---

408-4105	Straight Action Crimper 217200-1
408-4190	C-Head Pneumatic Adapter (Crimper) 318161-1
408-4198	Pneumatic Crimping Head Assembly 314991-1
408-4303	Pneumatic CERTI-CRIMP* Tool Holder Assemblies 356303-1 (Small) and 356302-1 (Large)
408-4321	Straight Action Tool Holder Assembly 356304-1 (Logic)
408-6757	Hydraulic Hand Crimping Tool 59974-1
408-6764	CERTI-LOK* Hand Tool Frame Assembly 169400
408-6765	Crimping Die Assembly 169404
408-8044	Miniature Quick-Change Applicator 687658-1 (Side-Feed with Mechanical Feed System)
408-8082	Miniature Quick-Change Applicators 567200-2 and -3 (Side-Feed with Air Feed System)
408-9177	Crimping Dies 47378-1, 48756-1, and 48757-1
408-9252	PRO-CRIMPER* III Hand Crimping Tool 58433-3
408-9535	Hydraulic Crimping Head 58422-1
408-9586	Pneumatic Crimping Heads 314269-1 and 314270-3
408-9684	Inspection and Servicing of Hydraulic Crimping Heads 69051, 58422-1, and 69066
408-9775	Pneumatic Crimping Heads 314868-1 and 314869-1
409-1950	Hydraulic Power Units 69120-1 and 69120-2
409-1993	AMP-TAPETRONIC* Machine 69875
409-2586	AMP-TAPETRONIC Machine 68250-1
409-2761	Pneudraulic Wiring Terminating Machine 68354-1
409-5128	Basic AMP-O-LECTRIC* Model "K" Terminating Machine 471273-[ ]
409-5842	AMP-O-LECTRIC Model "G" Terminating Machine 354500-[ ]
409-5852	AMPOMATOR* CLS III-G Lead-Making Machine 122500-[ ]
409-5860	Hydraulic Hand Pump 314979-1
409-5862	626 Pneumatic Tooling Assemblies 189721-[ ] and 189722-[ ]
409-5878	AMPOMATOR CLS IV Lead-Making Machine 356500-[ ]

### 3. REQUIREMENTS

#### 3.1. Special Characteristics

Terminals with an open-ended tongue, such as spade terminals, can be installed and removed without complete removal of the mounting screw. The terminal flat sides provide a locking feature against lateral stress; flanged ends reduce possibility of terminal separation. The snap feature on spring spade terminals increases resistance to axial loads if the mounting screw becomes loosened. The closed-end tongue, in terminals such as ring tongue terminals, provides maximum protection against separation; these terminals are well suited for high vibration environments.

#### 3.2. Material

The terminal body and splice body is made of copper plated with tin—except the spring spade terminal is made of phosphor bronze plated with tin or brass plated with tin, and the .093-Series plug terminal is made of brass. Rivets on the 3-way link terminal and tube cap assembly are made of brass and the tube cap on the tube cap assembly is made of copper zinc alloy. The insulation is made of vinyl or PVF<sup>2</sup> (polyvinylidene fluoride). The vinyl insulation is highly resistant to abrasion. The PVF<sup>2</sup> insulation is highly resistant to radiation and solvents.

#### 3.3. Storage

##### A. Shelf Life

The terminals and splices should remain in the shipping containers until ready for use to prevent deformation to the terminals and splices. The terminals and splices should be used on a first in, first out basis to avoid storage contamination that could adversely affect signal transmissions.

##### B. Ultraviolet Light

Prolonged exposure to ultraviolet light may deteriorate the chemical composition used in the terminal and splice insulation material.

##### C. Reeled Terminals and Splices

When using tape-mounted reeled terminals or splices, care must be taken to prevent stretching, sagging, or other distortion that would prevent smooth feeding of the tape through automatic machine feed mechanisms. Store coil wound reels horizontally and traverse wound reels vertically.

### 3.4. Chemical Exposure

Do not store terminals or splices near any chemical listed below as they may cause stress corrosion cracking in the terminal or splices.

Alkalies	Ammonia	Citrates	Phosphates	Citrates	Sulfur Compounds
Amines	Carbonates	Nitrites	Sulfur	Nitrites	Tartrates

### 3.5. Wire Selection and Preparation

The terminals and splices will accept solid or stranded copper wire sizes 26 through 1/0 AWG and stranded wire sizes 8 through 2/0 AWG (509 through 150,500 circular mil area) with an insulation diameter range of 1.27 through 19.69 [.050 through .775]. Proper strip length is necessary to properly insert the wire into the terminal or splice. The strip length of the wire is shown in Figure 2.



*Reasonable care must be taken not to nick, scrape, or cut any strands during the stripping operation.*

### 3.6. Wire Placement

Stranded wire conductors must be inside the terminal or splice wire barrel. No strands can be folded back over the wire insulation. Conductor ends must be bottomed in the wire barrel. The wire insulation must be inside the insulation of the terminal or splice, but must not enter the wire barrel, to provide strain relief for the wire.

### 3.7. Crimp Requirements

The terminal or splice must be crimped to the wire according to instructions packaged with applicable tooling.

#### A. Wire Barrel Crimp

The crimp applied to the wire barrel portion of the terminal or splice is the most compressed area and is most critical in ensuring optimum electrical and mechanical performance of the crimped terminal or splice. The crimped area must be symmetrical on both sides of the wire barrel of the terminal or splice. The crimp may be off center on the wire barrel but not off the end of the wire barrel. See Figure 3.

#### B. Crimp Dot Code

Some tools with multiple crimping chambers will emboss a crimp dot code onto the terminal or splice insulation when crimped. The crimp dot code must be fully formed on the insulation to indicate that the correct product and tooling combination was used. The crimp dot code must correspond with the wire size marking on the tooling. See Figure 3.

#### C. Wire Conductor and Insulation Location

After crimping, all conductors must be held firmly inside the wire barrel. No strands can be folded back over the wire insulation. The wire insulation must be inside the insulation barrel of the terminal or splice, but must not enter the wire barrel. Conductor ends must be flush with, or extend slightly beyond, the end of the wire barrel; or, in splices with a wire stop inside the center of the splice, conductor ends must butt against the wire stop. See Figure 3.



*Wire insulation shall NOT be cut or broken during the crimping operation. Reasonable care should be taken to provide undamaged wire terminations.*

#### D. Terminal or Splice Insulation

The terminal or splice insulation must not be deformed, cut, or show uneven stress marks. See Figure 3.

#### E. Bellmouth

There shall be no rear bellmouth. The front bellmouth shall be evident as shown in Figure 3.

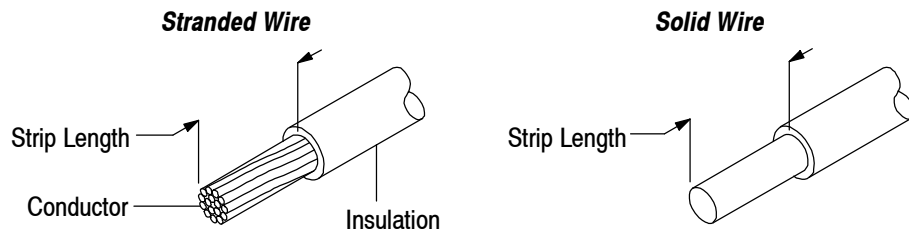

TERMINAL OR SPLICE		WIRE INSULATION DIA RANGE	WIRE STRIP LENGTH			WIRE CIRCULAR MIL AREA (CMA)
SIZE	INSULATION COLOR		TERMINAL	BUTT SPLICE	PARALLEL SPLICE	
26-22	Yellow	1.27-2.03 [.050-.080]	—	4.34-5.16 [.171-.203]	—	202-810
24-20	White	2.03-3.18 [.080-.125]	4.75-5.54 [.187-.218]	—	—	320-1,290
22-16	Red	—	5.16-5.94 [.203-.234]	6.35-7.14 [.250-.281]	7.87-8.64 [.310-.340]	509-3,260
	Natural/Red	—				
	Black	—				
20-16 HD	Natural/Green	2.92-4.32 [.115-.170]	5.16-5.94 [.203-.234]	—	—	810-3,260
16-14	Blue	—	5.16-5.94 [.203-.234]	6.35-7.14 [.250-.281]	7.87-8.64 [.310-.340]	2,050-5,180
	Natural/Blue	—				
	Black	—				
16-14 HD	Yellow/Black	—	7.92-8.71 [.312-.343]	—	—	2,050-5,180
	Black	—				
12-10	Yellow	—	7.92-8.71 [.312-.343]	7.92-8.71 [.312-.343]	7.92-8.71 [.312-.343]	5,180-13,100
	Natural/Yellow	—				
	Black	—				
8	Red	—	11.51-12.29 [.453-.484]	8.33-9.12 [.328-.359]	—	13,100-20,800
	Natural/Red	—	8.33-9.12 [.328-.359]	—	—	
6	Blue	—	15.47-16.26 [.609-.640]	9.93-10.72 [.391-.422]	—	20,800-33,100
	Natural/Blue	—	9.93-10.72 [.391-.422]	—	—	
4	Yellow	—	15.47-16.26 [.609-.640]	—	—	33,100-52,600
	Natural/Yellow	1.27-13.08 [.050-.515]	9.93-10.72 [.391-.422]	—	—	
2	Red	—	11.51-12.29 [.453-.484]	—	—	52,600-83,700
	Natural/Red	12.19-14.22 [.480-.560]	11.51-12.29 [.453-.484]	—	—	
1/0	Blue	—	18.67-21.82 [.735-.859]	—	—	83,700-119,500
2/0	Yellow	—	18.67-21.82 [.735-.859]	—	—	119,500-150,500
	Natural/Yellow	16.00-19.68 [.630-.775]	18.67-21.82 [.735-.859]	—	—	

Figure 2

Terminal

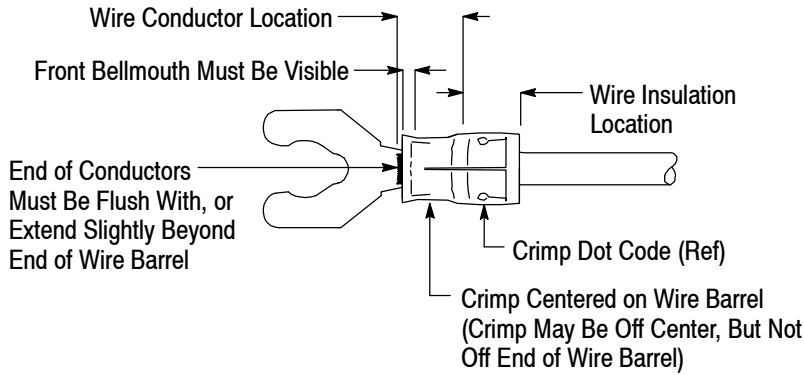

Plug Terminal

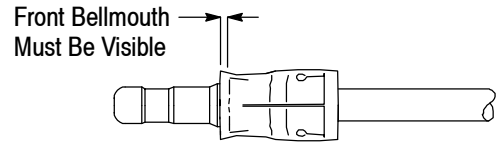

Splice

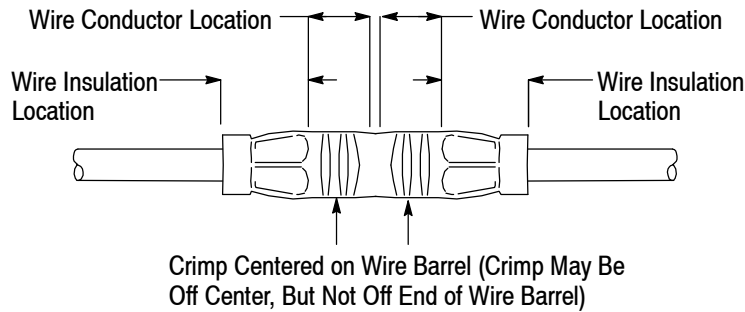

TERMINAL OR SPLICE SIZE	SOLDER SLUG		
	DIAMETER	CRIMP HEIGHT RANGE (See Notes)	
		CRESCENT CRIMP	CRIMP PRODUCED BY TETRA-CRIMP TOOLING
26-22	3.18 [.125]	1.60-1.75 [.063-.069]	—
24-20		2.26-2.41 [.089-.095]	—
22-16	3.18 [.125]	2.77-2.92 [.109-.115]	1.98-2.18 [.078-.086]
20-16 HD	4.76 [.188]	3.02-3.18 [.119-.125]	2.34-2.54 [.092-.100]
16-14			
16-14 HD	6.35 [.250]	4.29-4.44 [.169-.175]	3.25-3.45 [.128-.136]
12-10			
8	6.35 [.250]	5.11-5.26 [.201-.207]	—
6	6.35 [.250]	6.02-6.17 [.237-.243]	—
4	9.53 [.375]	6.83-6.98 [.269-.275]	—
2	9.53 [.375]	8.10-8.26 [.319-.325]	—
1/0	12.70 [.500]	10.19-10.34 [.401-.407]	—
2/0	15.88 [.625]	10.67-12.83 [.499-.505]	—

**Note:** The resilience of the terminal and splice insulation prevents accurate direct measurement of crimp height. Crimp height can be obtained by measuring a crimped solder slug (60% tin and 40% lead) with a diameter comparable to the wire size. The slug must be measured over the most compressed area of the slug with a standard micrometer or crimp height comparator (refer to Instruction Sheet 408-7424 for specific instructions). The solder slug diameter and crimp height must be within the dimensions provided.

**Note:** Each crimp dimension represents the functional range of a wire/terminal or splice combination. There are tool designs available to meet various application requirements. The developed crimp configuration is unique for each tool design and is acceptable provided the crimp height is within the functional range. For crimp dimensions of a specific tool, refer to instruction sheet packaged with manual tools and applicator log packaged with power tools.

Figure 3

**F. Tensile Strength**

Crimped terminals or splices must hold the wire firmly and have a crimp pull-out test value meeting that specified in Figure 4.

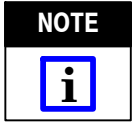

*Adjust tensile testing machine for head travel of 25.4 [1.0] per minute. Directly and gradually apply force for one minute.*

WIRE SIZE (AWG)	TENSILE FORCE (N [lb]) Min
26	13.4 [3]
24	22.3 [5]
22	35.6 [8]
20	57.9 [13]
18	89.0 [20]
16	133.5 [30]
14	222.5 [50]
12	311.5 [70]
10	356.0 [80]
8	400.5 [90]
6	445.0 [100]
4	623.0 [140]
2	801.0 [180]
1/0	1112.5 [250]
2/0	1235.0 [300]

Figure 4

**G. Bend Allowance**

The force applied during crimping may cause some bending between the wire barrel and wire. Such deformation is acceptable within the following limits.

1. Up and Down

The crimped portion must not be bent beyond the limits shown in Figure 5.

2. Side-to-Side

The crimped portion must not be bent from one side to the other beyond the limits shown in Figure 5.

**3.8. Repair**

Damaged terminals and splices or terminals and splices that do not meet crimp dimension requirements must be removed from wires, discarded, and replaced with new ones. When removing a terminal or splice, cut the wires as close as possible to the end of the wire barrel.

**4. QUALIFICATION**

PLASTI-GRIP terminals and splices are Listed by Underwriters Laboratories Inc. (UL) in File E13288, and Certified by CSA International in File LR7189; except multi stud ring, ring tongue bent 90°, and tube cap terminals.

**Up and Down Bend**

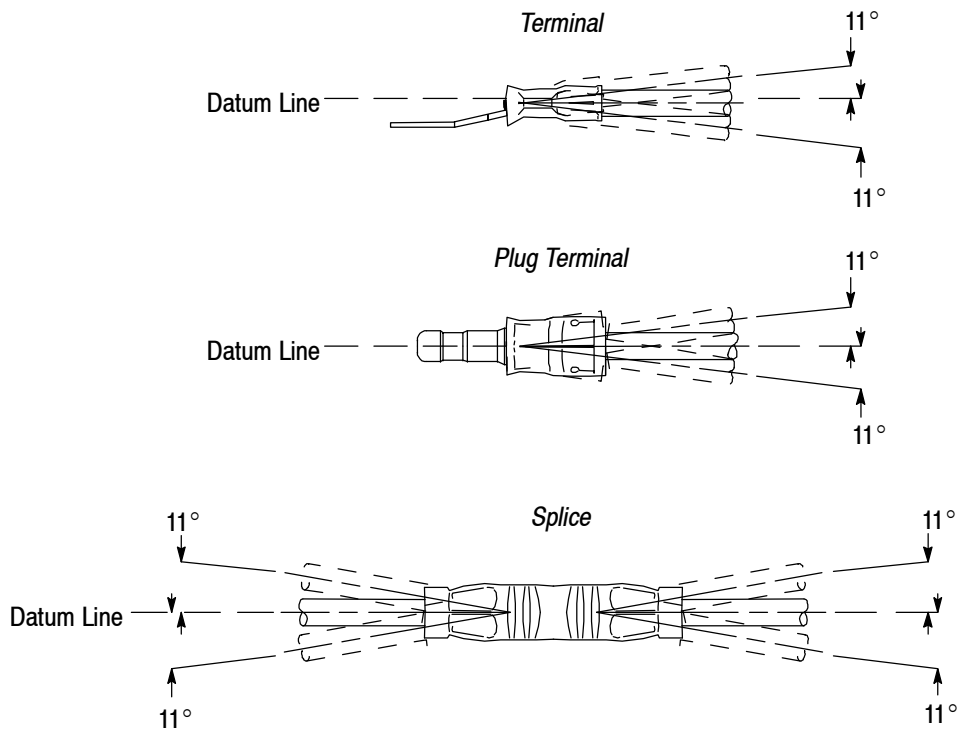

**Side-to-Side Bend**

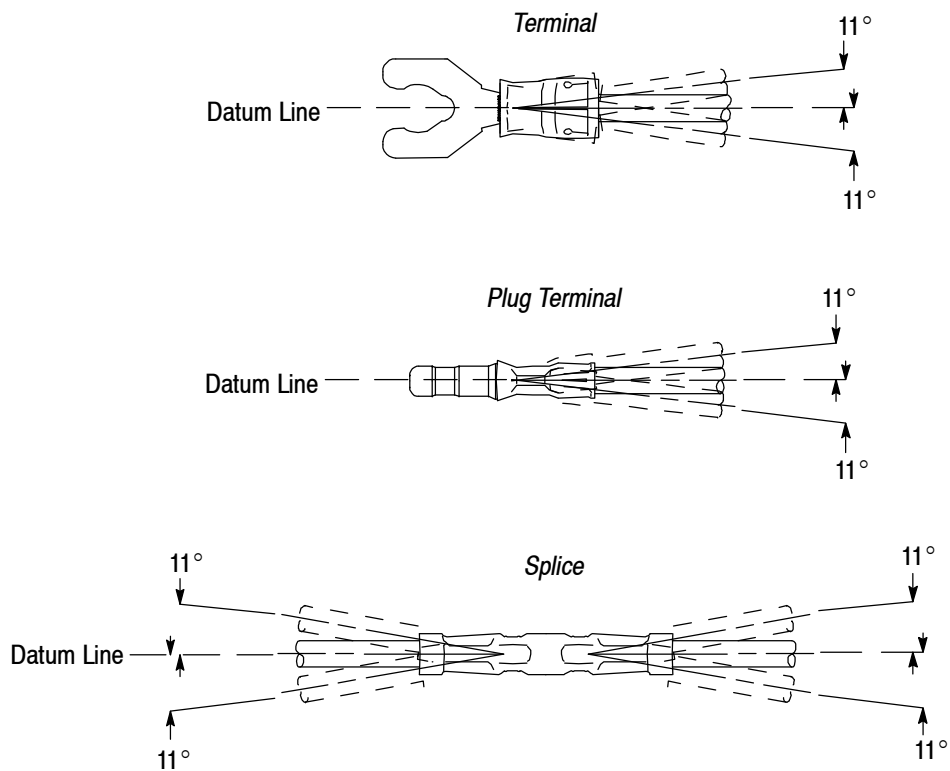

Figure 5



## 5. TOOLING

Hand tools for manual application of loose piece terminals and splices, and automatic and semi-automatic machines for power assisted application of tape-mounted terminals and splices are available to cover the full wire size range. Tooling part numbers and instructional material packaged with the tooling are shown in Figure 6.

**NOTE**

*Modified designs and additional tooling concepts may be available to meet other application requirements. Tool Engineers have designed machines for a variety of application requirements. For assistance in setting up prototype and production line equipment, contact Tool Engineering through your local Tyco Electronics Representative or call the Tooling Assistance Center at the number at the bottom of page 1.*

### 5.1. Hand Crimping Tool

The hand crimping tools consist of a handle assembly with integral fixed jaws or fixed dies, or a head that accepts various die assemblies. The jaws or dies have one or more crimping chambers used to crimp terminals and splices onto pre-stripped wire. The hand tool assemblies have a ratchet, except the hydraulic hand crimping tool which uses hydraulic fluid, to ensure full crimping pressure is applied to the terminal or splice.

### 5.2. 626 Pneumatic Tooling System

The pneumatic tooling system consists of a pneumatic power unit, tool holder assembly, and variety of crimping heads used to crimp terminals and splices onto pre-stripped wire. This tooling system was developed to reduce operator fatigue and provide interchangeability of die assemblies. The system is designed for prototype and medium-volume application of loose piece terminals and splices.

### 5.3. Pneumatic Tool

The pneumatic tool uses a pneumatic crimping head which contains jaws to crimp terminal and splices onto pre-stripped wires. This tool uses a filter and moisture separator, regulator, and lubricator. This tool is designed for low-volume application.

### 5.4. Applicator

The applicators are designed to crimp tape-mounted terminals and splices onto pre-stripped wire, for high volume, heavy duty production requirements. These applicators accept interchangeable crimping dies and must be installed onto a power unit.

### 5.5. Power Unit

#### A. Hydraulic Machine

The hydraulic power units combine the convenience of a hand tool with the power of a larger machine to crimp loose piece terminals and splices onto pre-stripped wire. Each unit uses a hydraulic head and interchangeable dies. These units are, basically, a portable crimping unit which uses a handle or foot control to activate a pump. They are used primarily for low-volume production or at locations where electrical power sources are not readily available.

#### B. Pseudraulic Machine

Pneudraulic power units provide the force required for automatic crimping tape-mounted terminals and splices. These machines accept interchangeable dies and are air-operated using a foot valve. These machines use a filter and moisture separator, regulator, and lubricator and are designed to be bench-mounted.

#### C. Semi-Automatic Machine

These power units provide the force required to drive applicators for crimping tape-mounted terminals and splices. They provide for medium-volume applications. These machines are designed to be bench mounted.

#### D. Automatic Machine

These power units provide the force required to drive applicators for crimping tape-mounted terminals and splices. They can be set up to automatically measure, cut, strip, and terminate wire. They provide for high volume, heavy duty production requirements. These machines are designed to be floor standing.

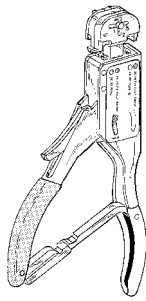

**"T"-HEAD Crimping Tools 59250, 59170 (408-1610)**

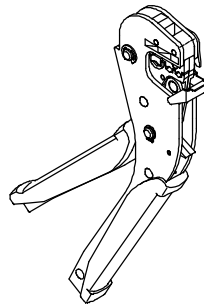

**TETRA-CRIMP Hand Crimping Tool 59824-1 (408-2823)**

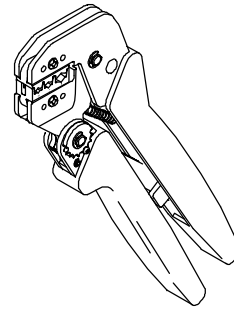

**PRO-CRIMPER Hand Crimping Tool 58433-3 (408-9252)**

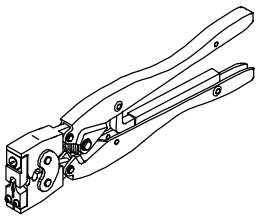

**Hand Crimping Tool 48040, 48049 (408-1570)**

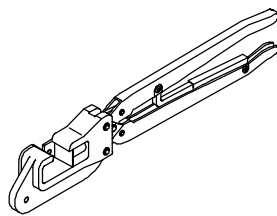

**Hand Crimping Tool 69710-1 (408-2095)  
59239-4 (408-1261)  
69959 (408-2434)  
59489, 59287-1 (408-1263)  
59270 (408-1256)  
CERTI-LOK Hand Tool Frame Assembly 169400 (408-6764)**

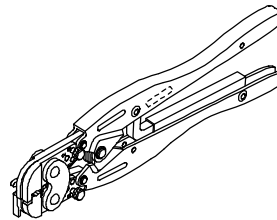

**Hand Crimping Tools 46121, 47386, 47387 (408-1559)  
45160, 45575-1 (408-1502)  
45449, 45450 (408-1548)**

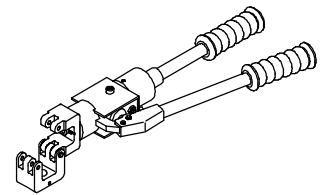

**Hydraulic Hand Crimping Tool 59974-1 (408-6757)**

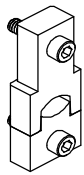

**Crimping Die Assemblies 69877, 69878, 69872, 69873, 68116-1 (408-2423)  
59826-1, 59827-1, 59828-1, 69874 (408-2822)  
69893 (408-2667)  
68247-1, 68248-1 (408-2592)  
68355-1 (408-2575)  
68356-1 (408-2567)**

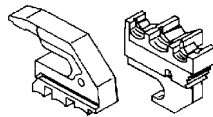

**Crimping Die Assembly 169404 (408-6765)**

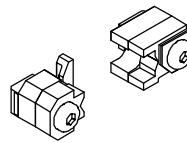

**Crimping Dies 47806-2, 47807-1, 47808-6 (408-1632)**

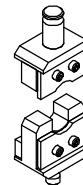

**Crimping Dies 47820, 47821, 47822, 47823 (408-1729)  
48752-1, 48753-1, 48754-1, 48755-1 (408-1758)  
47238-1, 48858-1, 48859-1, 48861-1 (408-1724)  
47378-1, 48756-1, 48757-1 (408-9177)**

Figure 6 (Cont'd)

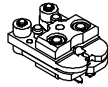

Pneumatic Crimping Heads  
314868-1, 314869-1 (408-9775)  
314269-1 , 314270-3 (408-9586)

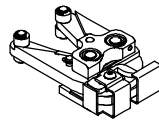

Pneumatic Crimping Head  
679300-1 (408-4071)

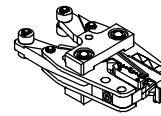

Pneumatic TETRA-CRIMP  
Adapter 679305-1  
(408-4099)

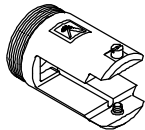

Large Tool Holder Assembly  
189767-1 (Non-Logic) (409-5862)  
356302-1 (Logic) (408-4303)

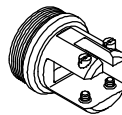

Straight Action Tool Holder Assembly  
189928-1 (Non-Logic) (409-5862)  
356304-1 (Logic) (408-4321)

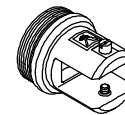

CERTI-CRIMP (Small) Tool  
Holder Assembly 189766-1  
(Non-Logic) (409-5862)  
356303-1 (Logic) (408-4303)

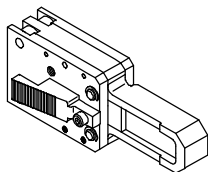

Straight Action Crimper  
217200-1 (408-4105)

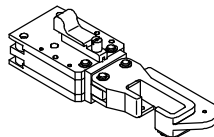

C-Head Pneumatic  
Adapter (Crimper)  
318161-1 (408-4190)

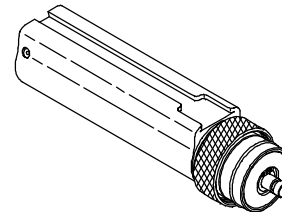

626 Pneumatic Tooling  
Assemblies 189721-[ ],  
189722-[ ] (409-5862)

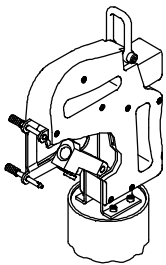

Pneumatic Tool  
69015 (408-1310)

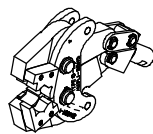

Pneumatic Crimping  
Head Assembly  
314991-1 (408-4198)

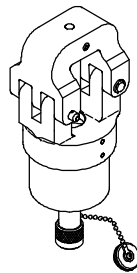

Hydraulic Crimping Head  
69051 (408-2450)  
58422-1 (408-9535)  
69066 (408-2453)

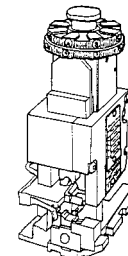

Miniature Quick-Change Applicator  
687658-1 (Side-Feed with Air  
Feed System) (408-8044)  
567200-3, 567200-2 (Side-Feed  
with Air Feed System) (408-8082)

Figure 6 (Cont'd)

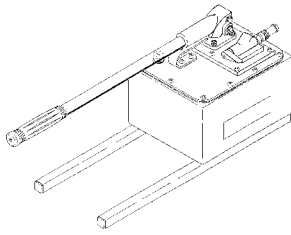

Hydraulic Hand Pump  
314979-1 (409-5860)

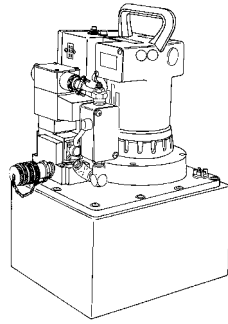

Hydraulic Power Units  
69120-1, 69120-2  
(409-1950)

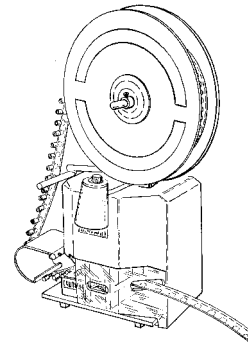

Pneudraulic Wire  
Terminating Machine  
68354-1 (409-2761)

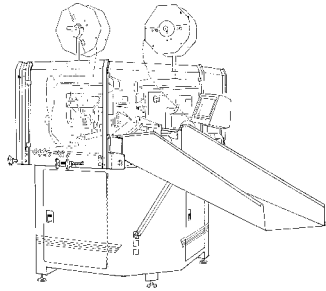

AMPOMATOR CLS III-G  
Lead-Making Machines  
122500-[ ] (409-5852)

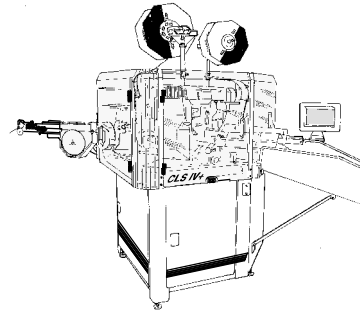

AMPOMATOR CLS IV +  
Lead-Making Machines  
356500-[ ] (409-5878)

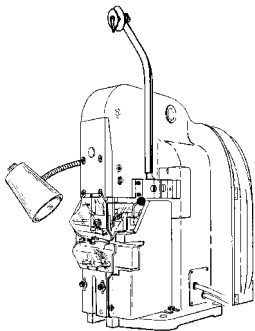

AMP-TAPETRONIC Machine  
68250-1 (409-2586)  
69875 (409-1993)

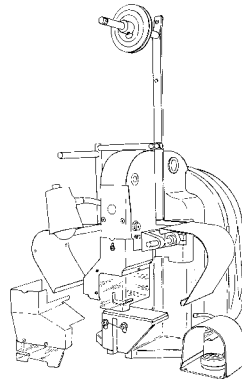

AMP-O-LECTRIC Model "K"  
Terminating Machine 1-471273-3  
or 565435-5 (Modified)  
No Longer Manufactured New  
(409-5128)

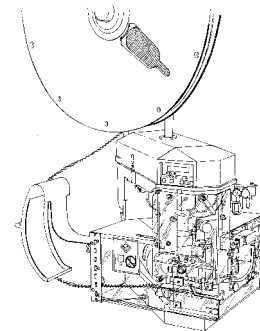

AMP-O-LECTRIC Model "G"  
Terminating Machines 354500-1  
(409-5842)

Figure 6 (Cont'd)

PRODUCT TYPE	WIRE SIZE (AWG)	CRIMPING DIE	HAND TOOL	TOOL HOLDER ASSEMBLY	HEAD OR ADAPTER	APPLICATOR	POWER UNIT
Terminals: Flag Multi Stud Ring Spade Tube Cap Wire Pin	24-20	69878	—	—	—	567200-2 or 567200-3	69875 or ②
	22-16	—	59250	—	—	—	—
		—	59170	—	—	—	—
		—	47386	—	—	—	—
		—	59824-1	—	—	—	—
		47806-2	189721-1 or 189722-1	189928-1 or 356304-1	217200-1	—	—
		47806-2	189721-2 or 189722-2	189928-1 or 356304-1	318161-1	—	—
		—	189721-1 or 189722-1	189767-1 or 356302-1	679305-1	—	—
		—	189721-1 or 189722-1	189766-1 or 356303-1	314270-3	—	—
		169404	169400	—	—	—	—
		59826-1, 69872, or 69893	—	—	—	687658-1	①
		59826-1, 69872, or 69893	—	—	—	—	69875
		59826-1 or 69872	—	—	—	567200-3	②
		59826-1 or 69872	—	—	—	567200-2	1-471273-2 or 565435-5 (Modified)
20-16 HD	—	48040	—	—	—	—	

① 122500-2, 122500-3, 356500-1, 356500-2

② 354500-1

Figure 6 (Cont'd)

PRODUCT TYPE	WIRE SIZE (AWG)	CRIMPING DIE	HAND TOOL	TOOL HOLDER ASSEMBLY	HEAD OR ADAPTER	APPLICATOR	POWER UNIT
Terminals: Flag Hook Multi Stud Ring Spade 3-Way Link Wire Pin	16-14	—	59250	—	—	—	—
		—	59170	—	—	—	—
		—	47387	—	—	—	—
		—	59824-1	—	—	—	—
		47807-1	189721-1 or 189722-1	189928-1 or 356304-1	217200-1	—	—
		47807-1	189721-2 or 189722-2	189928-1 or 356304-1	318161-1	—	—
		—	189721-1 or 189722-1	189767-1 or 356302-1	679305-1	—	—
		—	189721-1 or 189722-1	189766-1 or 356303-1	314269-1	—	—
		169404	169400	—	—	—	—
		59827-1 or 69873	—	—	—	687658-1	①
		59827-1 or 69873	—	—	—	—	69875
		59827-1 or 69873	—	—	—	567200-3	②
		59827-1 or 69873	—	—	—	567200-2	354500-1
	16-14 HD	—	189721-1 or 189722-1	189767-1 or 356302-1	679300-1 or 679305-1	—	—
		47808-6	189721-1 or 189722-1	189928-1 or 356304-1	217200-1	—	—
		47808-6	189721-2 or 189722-2	189928-1 or 356304-1	318161-1	—	—
		47808-6	69710-1	—	—	—	—
		169404	169400	—	—	—	—
		—	59824-1	—	—	—	—
		—	58433-3	—	—	—	—
		—	48049	—	—	—	—
		—	59239-4	—	—	—	—

① 122500-2, 122500-3, 356500-1, 356500-2

② 354500-1

Figure 6 (Cont'd)

PRODUCT TYPE	WIRE SIZE (AWG)	CRIMPING DIE	HAND TOOL	TOOL HOLDER ASSEMBLY	HEAD OR ADAPTER	APPLICATOR	POWER UNIT
Terminals: Flag Ring Spade Wire Pin	12-10	—	59239-4	—	—	—	—
		—	59824-1	—	—	—	—
		—	58433-3	—	—	—	—
		—	48049	—	—	—	—
		—	189721-1 or 189722-1	189767-1 or 356302-1	679300-1 or 67305-1	—	—
		47808-6	189721-1 or 189722-1	189928-1 or 356304-1	217200-1	—	—
		47808-6	189721-2 or 189722-2	189928-1 or 356304-1	318161-1	—	—
		169404	169400	—	—	—	—
		59828-1 or 69874	—	—	—	687658-1	①
		59828-1	—	—	—	—	69875
		59828-1 or 69874	—	—	—	567200-3	②
		59828-1 or 69874	—	—	—	567200-2	354500-1
Terminals: Ring	8	—	69959	—	—	—	—
		47820 or 48752-1	59974-1	—	—	—	—
		47820 or 48752-1	—	—	69051	—	—
		48858-1	—	—	58422-1 or 69066	—	③
		68247-1	—	—	—	—	68250-1
		68116-1	—	—	—	—	69875
		68355-1	—	—	—	—	68354-1

① 122500-2, 122500-3, 356500-1, 356500-2

② 354500-1

③ 69120-1, 69120-2, or 314979-1

Figure 6 (Cont'd)

PRODUCT TYPE	WIRE SIZE (AWG)	CRIMPING DIE	HAND TOOL	TOOL HOLDER ASSEMBLY	HEAD OR ADAPTER	APPLICATOR	POWER UNIT
Terminals: Ring	6	47821 or 48753-1	59974-1	—	—	—	
		47821	—	—	69051	—	③
		48859-1	—	—	58422-1 or 69066	—	314979-1
		48753-1	—	—	69051	—	③
		48859-1	—	—	58422-1 or 69066	—	③
		68248-1	—	—	—	—	68250-1
		68356-1	—	—	—	—	68354-1
	4	47822 or 48754-1	59974-1	—	—	—	—
		—	69015	—	314991-1	—	—
		47822 or 48754-1	—	—	69051	—	③
		47238-1	—	—	58422-1 or 69066	—	③
	2	47823 or 48755-1	59974-1	—	—	—	—
		47823 or 48755-1	—	—	69051	—	③
		48861-1	—	—	69066 or 58422-1	—	③
	1/0	47378-1 or 48756-1	—	—	69066 or 58422-1	—	③
		48861-1	—	—	58422-1	—	③
	2/0	48757-1	—	—	58422-1 or 69066	—	③

③ 69120-1, 69120-2, or 314979-1

Figure 6 (Cont'd)



PRODUCT TYPE	WIRE SIZE (AWG)	CRIMPING DIE	HAND TOOL	TOOL HOLDER ASSEMBLY	HEAD OR ADAPTER	APPLICATOR	POWER UNIT
SHUR-PLUG* Terminals	22-16	—	45160	—	—	—	—
		—	189721-1 or 189722-1	189766-1 or 356303-1	314868-1	—	—
	16-14	—	59250	—	—	—	—
		—	47387	—	—	—	—
		—	189721-1 or 189722-1	189766-1 or 356303-1	314269-1	—	—
		47807-1	189721-1 or 189722-1	189928-1 or 356304-1	—	—	—
		—	189721-1 or 189722-1	189767-1 or 356302-1	679305-1	—	—
		—	59824-1	—	—	—	—
		—	58433-3	—	—	—	—
		169404	169400	—	—	—	—
		59827-1 or 69873	—	—	—	687658-1	①
		59827-1 or 69873	—	—	—	—	69875
		59827-1 or 69873	—	—	—	567200-3	②
		59827-1 or 69873	—	—	—	567200-2	1-471273-2 or 565435-5 (Modified)

① 122500-2, 122500-3, 356500-1, 356500-2

② 354500-1

Figure 6 (Cont'd)

PRODUCT TYPE	WIRE SIZE (AWG)	CRIMPING DIE	HAND TOOL	TOOL HOLDER ASSEMBLY	HEAD OR ADAPTER	APPLICATOR	POWER UNIT
Butt Splice	26-22	—	46121	—	—	—	—
		69877	—	—	—	687658-1	①
		69877	—	—	—	—	69875
		69877	—	—	—	567200-3	②
		69877	—	—	—	567200-2	354500-1
	22-16	—	45160	—	—	—	—
		—	58433-3	—	—	—	—
		—	189721-1 or 189722-1	189766-1 or 356303-1	314868-1	—	—
		69872	—	—	—	687658-1	①
		69872	—	—	—	—	69875
		69872	—	—	—	567200-3	②
		69872	—	—	—	567200-2	354500-1
	16-14	—	45575-1	—	—	—	—
		—	58433-3	—	—	—	—
		—	189721-1 or 189722-1	189766-1 or 356303-1	314869-1	—	—
		69873	—	—	—	—	69875
		69873	—	—	—	567200-3	②
		69873	—	—	—	567200-2	354500-1
	12-10	—	59287-1	—	—	—	—
		—	59489	—	—	—	—
		—	58433-3	—	—	—	—
		69874	—	—	—	687658-1	①
		69874	—	—	—	567200-3	②
		69874	—	—	—	—	69875
Parallel Splice	22-16	—	45449	—	—	—	
	16-14	—	45450	—	—	—	
	12-10	—	59270	—	—	—	

① 122500-2, 122500-3, 356500-1, 356500-2

② 354500-1

Figure 6 (End)

6. VISUAL AID

Figure 7 shows a typical application of PLASTI-GRIP terminals and splices. This illustration should be used by production personnel to ensure a correctly applied product. Applications which DO NOT appear correct should be inspected using the information in the preceding pages of this specification and in the instructional material shipped with the product or tooling.

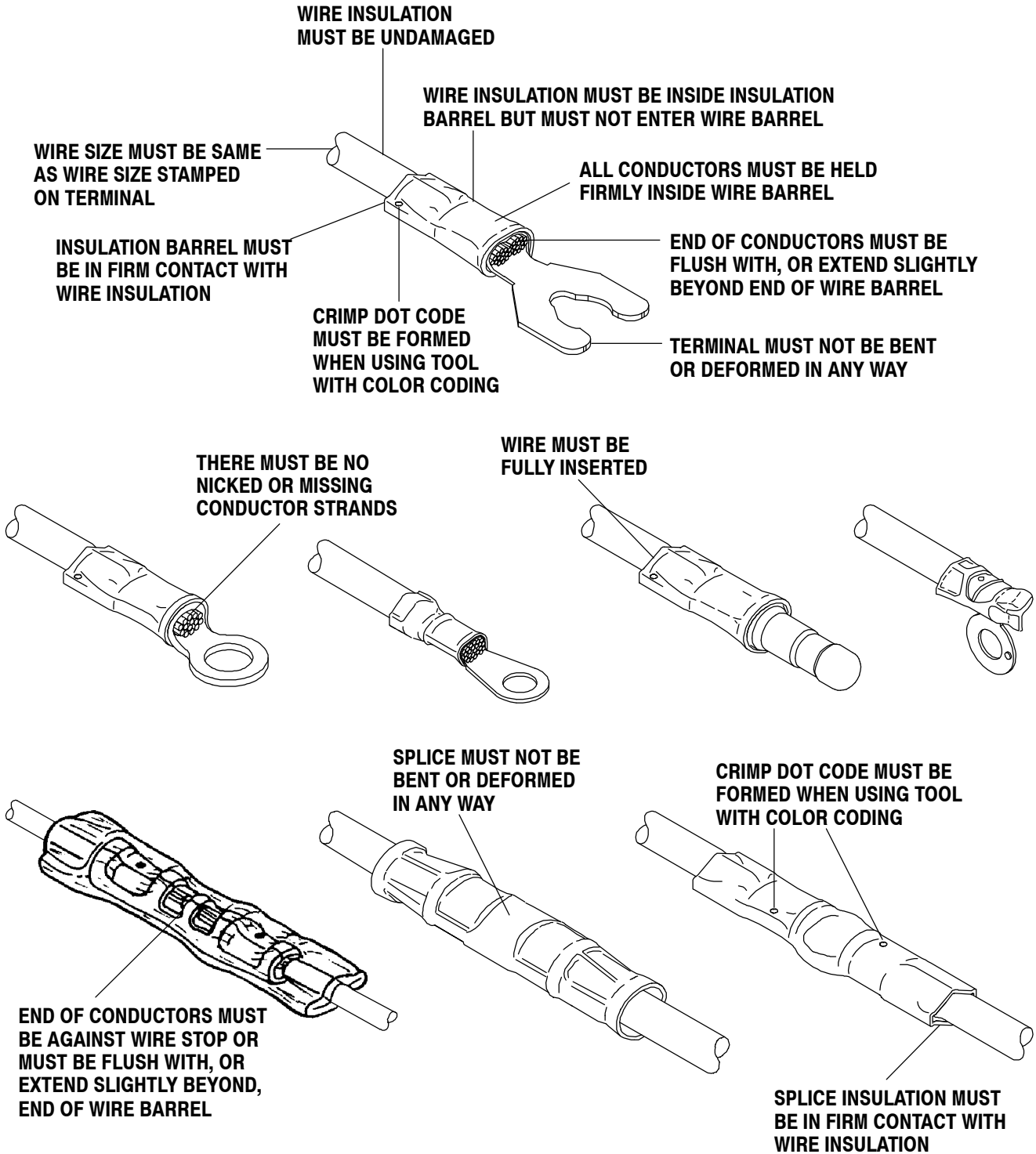

FIGURE 7. VISUAL AID