

Figure 1

**1. INTRODUCTION**

PRO BEAM Jr. EB cable plug connectors are designed to be installed onto jacketed fiber optic cable with aramid fiber strength members.

**NOTE** *Dimensions in this instruction sheet are in metric units. Figures are not drawn to scale.*

The connector must be assembled using a cable plug connector shell kit, an EB insert assembly kit, ferrule assembly kit (one for each fiber or channel), and a cable adapter kit. Sample part numbers are given in Figure 1. The combination of the kits selected is based on the diameter of the cable, the mode and quantity of fibers, and the operating wavelength of the system.

**CAUTION** *To avoid poor optical performance or permanent damage to the lens of the EB insert, use ONLY Tyco Electronics ferrule assembly kits. Other manufacturers' ferrule assemblies ARE NOT compatible with the EB insert assembly kit.*

**2. DESCRIPTION**

Each kit contains the components shown in Figure 1. The EB insert assembly kit is shipped with a white protective label on the back (end opposite the lens) of the EB insert which is installed immediately after final testing to keep the channel cavities clean. The EB insert is ready for assembly as shipped.

**3. HANDLING**

**DANGER** *To avoid personal injury, NEVER look into the end of terminated or unterminated optical fibers. Laser radiation is invisible but can damage eye tissue.*

- Do not touch the lens of the EB insert with your fingers or with any tools

**NOTE** *If the lens is touched or otherwise contaminated, clean the lens according to Instruction Sheet 408-8828.*

- Always have the protective cap installed or the connector mated to prevent contamination to the EB insert assembly

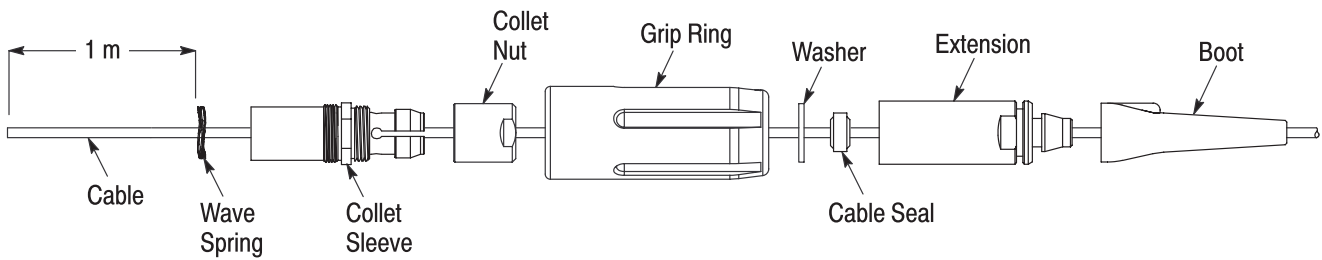

Figure 2

**4. TOOLS AND MATERIALS**

The following tools and materials are necessary for preparation, assembly, inspection, and maintenance of the connector and cable assembly. Follow the operating instructions packaged with the tools and safety guidelines packaged with the materials.



*Items without a part number or supplier are customer supplied.*

**4.1. Tools**

- cable jacket strip tool
- Aramid Fiber Shears 1278637-1
- SDE PEW 12 Hand Tool 91382-1 with Die Set 1673667-1 (408-8795)
- micrometer or vernier, dial, or digital caliper
- Fiber Stripping Tool 504024-1 (125- $\mu$ m, red handle) (408-9485)
- Heat Cure Oven Assembly 502134-1 (120 Vac) or -2 (240 Vac) includes universal heat cure block (408-9460)
- Curing Fixture 1693797-1 (408-8857)
- Sapphire Scribe Tool 504064-1 (408-4293)
- polishing machine (recommended) or Polishing Bushing 504862-1 (for hand polishing)
- 200 $\times$  Microscope 1754767-1
- Ferrule Insertion Tool 1693820-1
- 2.5-mm hex wrench
- EB Insert Assembly Fixture 1515844-1
- Bench-Mount Assembly Fixture 1918503-2 or 1918503-3
- 15-mm U-wrench
- 17-mm U-wrench
- heat gun

**4.2. Materials**

- LOCTITE 480 PRISM Instant Adhesive
- lint-free tissues or cloths

Loctite, 480, Prism, and 243 are trademarks of Henkel Corporation.  
Dow Corning and Molykote are trademarks of Dow Corning Corporation.

- isopropyl alcohol (99%) or acetone
- Epoxy 504035-1 (4 grams)
- Epoxy Mixer 501202-1
- Epoxy Applicator Kit 501473-3

For hand polishing only:

- 5- $\mu$ m Aluminum Oxide Polishing Film 228433-8
- 1mm Rubber Polishing Pad 501858-1 (green)
- Polishing Plate 501197-1 (216 $\times$ 280 mm)
- 0.3- $\mu$ m Diamond Polishing Film 228433-5
- Final Polishing Film 502748-2

- lint-free applicator swabs
- DOW CORNING MOLYKOTE 55M Grease
- LOCTITE 243 Threadlocker Medium Strength

**5. ASSEMBLY PROCEDURE**

**IMPORTANT:** Assemble the connector using a laminar flow table in a clean environment meeting the requirements of International Organization for Standardization (ISO) 14644-1 (Class 5), “Cleanrooms and Associated Controlled Environments, Part 1.” Make sure that all components are free from contamination.

Proceed as follows:



*If using a 4-fiber breakout cable (which requires a 7.5-mm cable adapter kit), refer to 408-10010 for the assembly procedure (which must be used in conjunction with these instructions).*

**5.1. Prepare the Cable**

1. Slide the components shown in Figure 2 onto the cable allowing 1 m at the end of the cable for stripping the cable. Make sure to orient each component as shown.
2. Using the cable jacket strip tool, strip the jacket to the dimension given in Figure 3, exposing the strength members and fiber.
3. Using the shears, trim the strength members to the length given in Figure 3.

**Cable Strip Length**

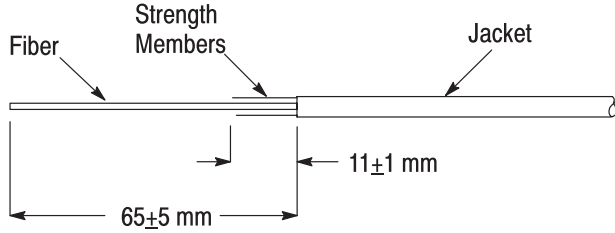

**Note:** Not to Scale

Figure 3



These instructions are for single-channel connectors. For multi-channel connectors, perform the same assembly procedure for each channel.

**5.2. Terminate the Fiber**

1. Apply 1 or 2 small drops of the instant adhesive onto the cable jacket between 4 and 5 mm from the stripped end of the jacket. See Figure 4, Detail A.
2. Slide the crimp support (large diameter end first) over the fibers and strength members and onto the jacket until it bottoms. See Figure 4, Detail B.
3. Apply a thin band of the instant adhesive around the knurled portion of the crimp support. Make sure that the band is continuous around the entire circumference. See Figure 4, Detail C.
4. Flare the strength members away from the fiber. See Figure 4, Detail C.

Then *quickly*, before the instant adhesive *begins* to harden, slide the crimp sleeve over the fiber, pushing the strength members back over the crimp support until it bottoms on the rear flange of the crimp support. See Figure 4, Detail D.



LOCTITE 480 PRISM Instant Adhesive is a cyanoacrylate which hardens extremely quick. If longer working time is needed, use EPO-TEK 353ND Epoxy instead (for this step only).

5. Place the crimp sleeve in the 8.6-mm hex nest of the hand tool, and crimp the crimp sleeve onto the crimp support. Make sure to position the crimp sleeve in the hex nest so that the crimp will locate from the back of the crimp sleeve to within the dimension shown in Figure 4, Detail E.

**Detail A**

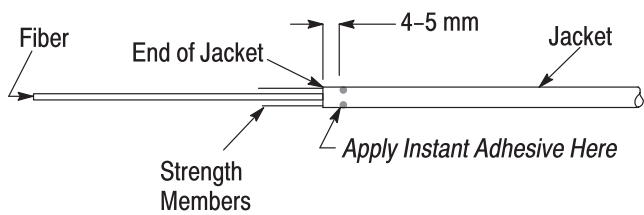

**Detail B**

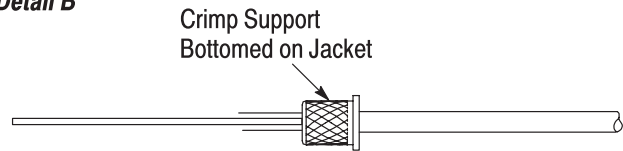

**Detail C**

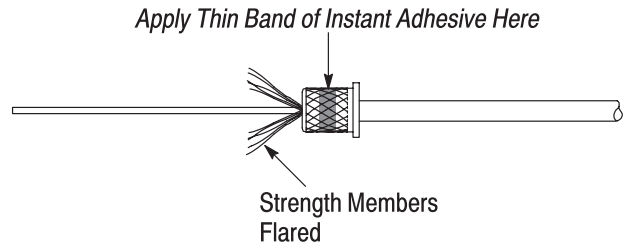

**Detail D**

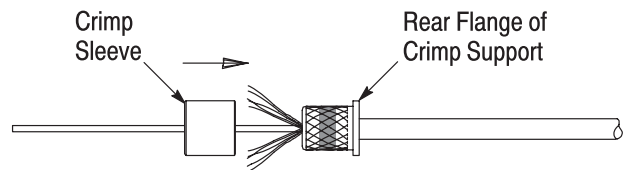

**Detail E**

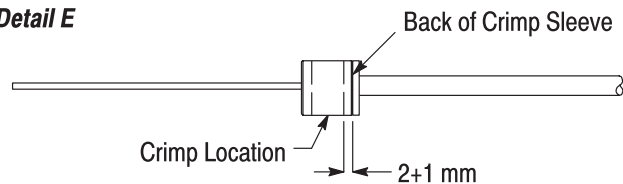

Figure 4

Loctite, 480, and Prism are trademarks of Henkel Corporation. EPO-TEK is a trademark of Epoxy Technology Inc. Corporation.

6. Using the micrometer or caliper, measure the crimp sleeve across the flats of the hex crimp to make sure that it conforms to the crimp height and crimp width shown in Figure 5, Detail A. If necessary, crimp again, and re-measure the crimp.

7. At the back of the crimp support, apply the instant adhesive around the circumference of the crimp support at the junction of the cable and the crimp sleeve, apply the adhesive over the opening of the crimp sleeve to encapsulate the strength members. See Figure 5, Detail B. Remove any excess adhesive.

8. Mark the fiber at the dimension shown in Figure 5, Detail C, and using the fiber stripping tool, strip the buffer to the mark, exposing the bare fiber. Using a lint-free tissue or cloth dampened with the isopropyl alcohol or acetone, clean the bare fiber.



*Take care not to break the bare fiber. If any part of the fiber breaks, the crimp support and crimp sleeve must be replaced, and the cable must be re-stripped.*

9. Slide the spring onto the fiber. See Figure 5, Detail D.

10. Pre-heat the heat cure oven to 100°C.

11. Prepare the epoxy according to the following:

- a. Remove the separating clip from the epoxy package. Using the epoxy mixer, mix the two components together thoroughly for 20 to 30 seconds.
- b. Install the needle tip on the applicator from the epoxy applicator kit. Make sure it is secure. Remove the plunger.
- c. Cut the epoxy packet open, and squeeze the epoxy into the back of the applicator. Re-assemble the plunger. Hold the applicator vertically, and slowly push on the plunger until the entrapped air escapes and a bead of epoxy appears at the needle tip.
- d. Using a lint-free tissue or cloth dampened with the isopropyl alcohol or acetone, clean the tip of the applicator.

12. Hold the ferrule assembly vertically, and insert the needle tip into the base of the ferrule assembly until it is against the back (end closest to the base) of the ferrule assembly. Refer to Figure 6.

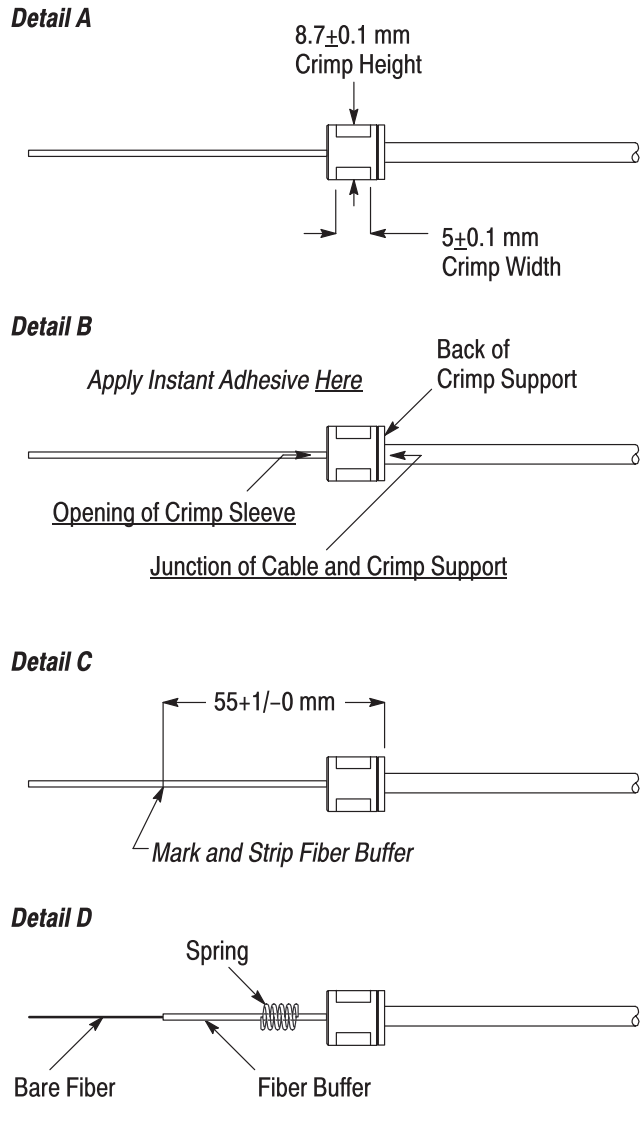

Figure 5

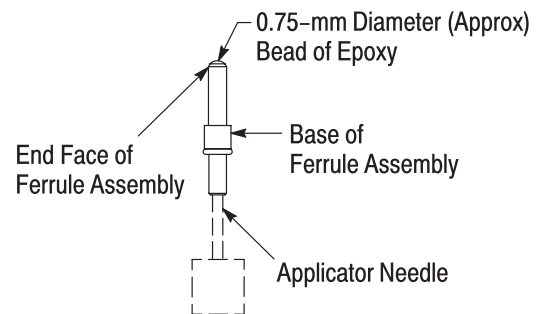

Figure 6

13. While holding the ferrule assembly *firmly* against the needle tip, *slowly* inject the epoxy until a small bead of epoxy (approximately 0.75 mm in diameter) forms at the end face of the ferrule assembly. DO NOT allow the bead to get too large or smear.

14. Withdraw the needle slightly, and inject an additional small amount of epoxy so that the cavity at the base of the ferrule assembly is approximately one-third to one-half full.



To avoid personal injury, remember that epoxy is a hazardous material, and pay particular attention to the following:

- ALWAYS follow manufacturer’s safety guidelines.
- ALWAYS wear protective gloves when using epoxy.
- ALWAYS use epoxy in a well ventilated area.
- AVOID prolonged and frequent contact with skin.
- AVOID inhaling fumes from epoxy.

15. Place the crimp sleeve and fiber into the curing fixture according to the instructions included with the curing fixture.

Carefully insert the fiber into the back of the ferrule assembly (previously prepared with epoxy). Simultaneously slide and rotate the ferrule assembly on the fiber (to prevent any air pockets from being trapped in the epoxy) until it bottoms. Make sure that the bare fiber is protruding from the end face of the ferrule assembly. If it is not, re-strip and re-terminate the fiber.

Place the ferrule assembly in the curing fixture according to 408-8857 (instructions included with the curing fixture).

16. Cure the assembly in the heat cure oven for 20 minutes. Remove the assembly from the oven, and allow the assembly to cool to room temperature.

17. Remove the assembly from the curing fixture according to 408-8857. Measure the assembly to make sure that it conforms to the dimension given in Figure 7. If it does not, re-strip and re-terminate the fiber.



Although the curing fixture is designed to ensure that the required functional length is obtained, it is still important to measure the assembly for this length after curing.

**5.3. Cleave the Fiber**

Firmly support the ferrule assembly, and draw the beveled edge of the scribe tool across the fiber as shown in Figure 8. After scoring the fiber, pull the fiber straight away from the ferrule assembly.

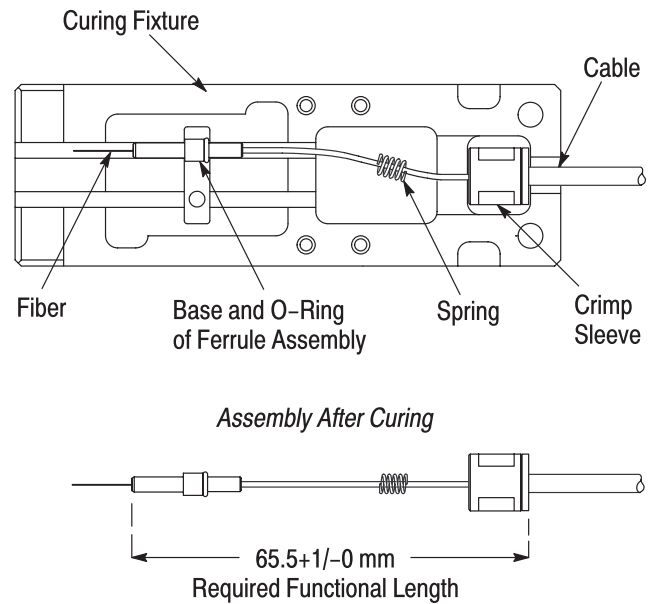

Figure 7

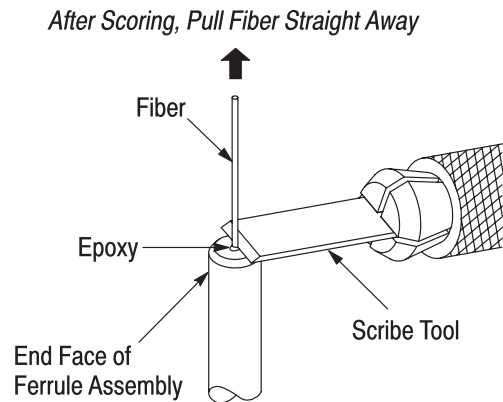

Figure 8



Safely dispose of excess fiber.



To avoid damage to the tip of the scribe tool, DO NOT allow the scribe tool to contact the epoxy.

**5.4. Polish the Fiber**

It is recommended polishing the fiber using a polishing machine. The polish must produce a super-physical contact (PC) end finish for singlemode connectors and a flat end finish for multimode connectors. *Machine polishing produces the best results.* Polish the fiber according to the machine manufacturer's instructions.

If machine polishing is not possible, hand polish the fiber according to the following:

1. Using a small piece of the 5- $\mu$ m polishing film, remove the fiber stub to the level of the epoxy.
2. Install the ferrule assembly onto the polishing bushing.

3. For singlemode connectors, place the green polishing pad on the polishing plate. Place the 5- $\mu$ m polishing film on the green polishing pad.

For multimode connectors, place the polishing plate on a hard flat surface. Place the 5- $\mu$ m polishing film on the polishing plate.

4. Hold the ferrule assembly and rest the tips of your index finger, middle finger, and thumb on the top of the polishing bushing. Starting with very light pressure, polish the tip of the fiber in a figure-8 pattern. Refer to Figure 9. Polish the fiber until the epoxy turns a very light yellow.

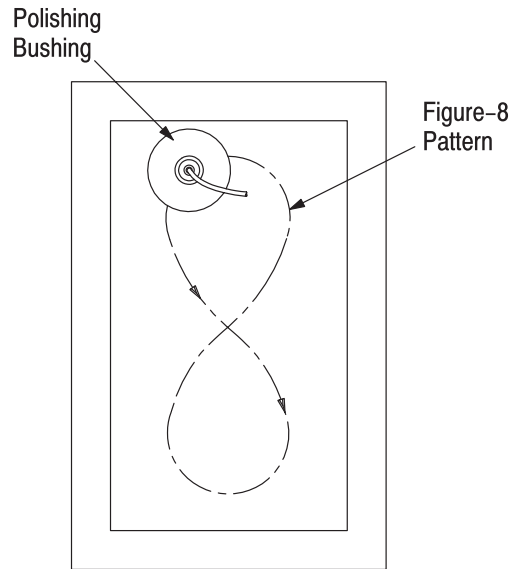



Figure 9

9. Remove the ferrule assembly from the polishing bushing. Clean the end face and sides of the ferrule assembly with isopropyl alcohol or acetone and a lint-free tissue.

**NOTE** *DO NOT remove all the epoxy. As the epoxy gets lighter, check the tip of the fiber frequently.*



5. Clean the end face of the ferrule assembly and polishing bushing with isopropyl alcohol or acetone and a lint-free tissue.

6. Place the 0.3- $\mu$ m polishing film on the polishing pad (singlemode) or polishing plate (multimode). Polish in a figure-8 pattern. Stop polishing as soon as all the epoxy is removed.

7. Clean the end face of the ferrule assembly and polishing bushing with isopropyl alcohol or acetone and a lint-free tissue.

8. Place the final polishing film on the polishing pad (singlemode) or polishing plate (multimode). Apply several drops of water to an unused area of the film. Move the ferrule assembly in 20-mm circles on the water for 25 seconds.

**NOTE** *One sheet of final polishing film will be sufficient for 10 to 20 ferrule assemblies.*





**5.5. Inspect the Ferrule Assembly and Fiber**



*Never inspect or look into the end of a fiber when optical power is applied to the fiber. The infrared light used, although it cannot be seen, can cause injury to the eyes.*

1. Using the microscope, inspect the ferrule assembly and fiber according to the following criteria (refer to Figure 10):

- Make sure that any epoxy is removed from the ferrule assembly
- Dirt may be mistaken for small pits. If dirt is evident on the ferrule assembly or fiber, clean with isopropyl alcohol or acetone and a lint-free tissue, then dry
- Fine polishing lines are acceptable
- Small peripheral chips (at the outer rim) on the fiber are acceptable
- Large chips in the center of the fiber and dark scratches are unacceptable, and the fiber must be re-terminated

2. If necessary, install the dust cover onto ferrule assembly to prevent contamination to the end face.

**5.6. Complete the Assembly**

1. Remove the protective label from the back (end opposite the lens) of the EB insert.
2. Align the end of the ferrule assembly with the appropriate channel cavity of the EB insert, and insert the ferrule assembly into the channel cavity until the O-ring is against the channel cavity. See Figure 11, Detail A. To avoid damage to the fiber, DO NOT push the fiber to install the ferrule assembly.

**IMPORTANT:** The channels for each fiber pair are designated on the EB insert with “A1” and “B1,” and “A2” and “B2”. For proper end-to-end system connection, connect A1 to B1, B1 to A1, A2 to B2, and B2 to A2.

3. Slide the spring over the fiber until it is against the O-ring of the ferrule assembly. See Figure 11, Detail B. Using the ferrule insertion tool, push the spring until the ferrule assembly bottoms in the channel cavity (the O-ring will be inside of the cavity, and the spring will protrude slightly from the cavity). See Figure 11, Detail B.



*If necessary, to remove the ferrule assembly from the cavity, firmly grasp the end of the ferrule assembly (but not the spring) with the needle-nose pliers, and pull it out of the cavity.*

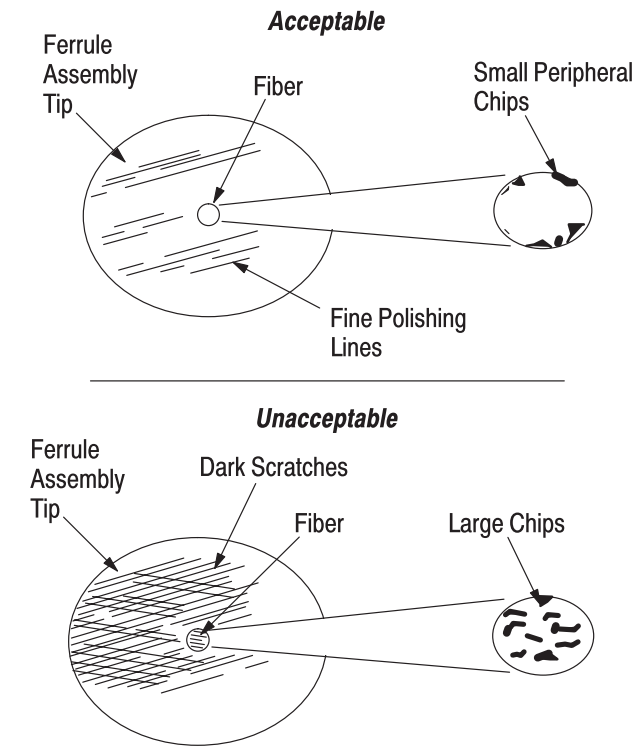
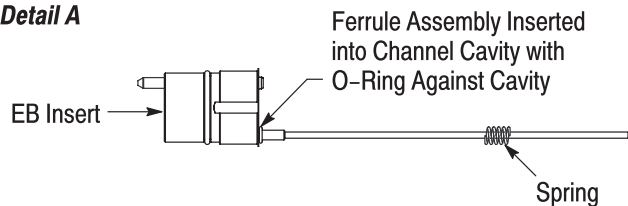

Figure 10

**Detail A**



**Detail B**

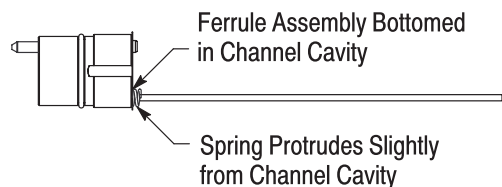
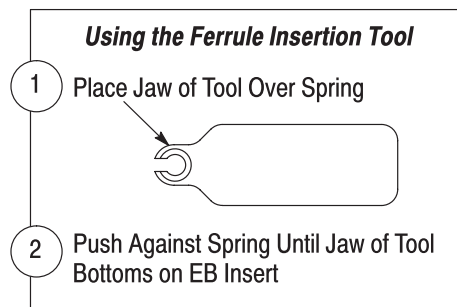
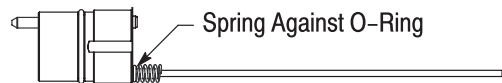

Figure 11



To avoid damage to the fiber, **DO NOT PULL OR PUSH THE FIBER** to install or remove the ferrule assembly from the cavity.

4. Align the index pin hole of the ferrule plate with the index pin at the back of the EB insert, and slip the fiber into the closest slotted hole in the ferrule plate. See Figure 12, Detail A.

5. Hold the ferrule plate against the EB insert, making sure that the index pin enters the index hole. Thread the screw through the screw hole of the ferrule plate and into the hole in the EB insert. See Figure 12, Detail B. Using the 2.5-mm hex wrench, tighten the screw to a torque between 0.8 and 1.0 N-m. Check to make sure that the ferrule plate is flush with the EB insert.

6. Align the guide pins with the guide holes, and fit the EB insert assembly fixture onto the EB insert assembly. Refer to Figure 12, Detail C.



Using the fixture will help guide the EB insert assembly into the housing and minimize the possibility of grease contaminating the face of the EB insert.

7. Using an applicator swab, apply a *thin film* of the grease around the O-ring of the EB insert and around the inside of the front seal on the inside of the housing. Remove any excess grease. Refer to Figure 13, Detail A.



To avoid contaminating optical components, **DO NOT** use heavy deposits of the grease.

8. Align the internal key (small bar inside) of the housing with the keyway (slot along the side) of the EB insert, and slide the fixture along with the EB insert assembly into the housing. See Figure 13, Detail B.

9. Using the 2.5-mm hex wrench, push the EB insert assembly into the housing until it bottoms. To avoid damage to the fiber, **DO NOT** push the fiber or cable to install the EB insert assembly.

10. Remove the fixture from the front of the housing.

11. Slide the wave spring over the crimp sleeve and into the housing. See Figure 13, Detail C.

Detail A

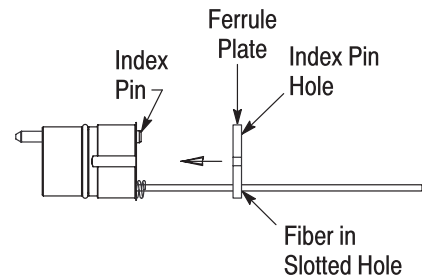

Detail B

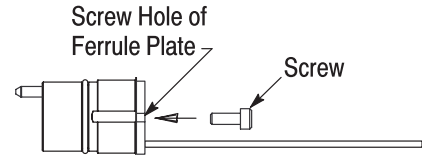

Detail C

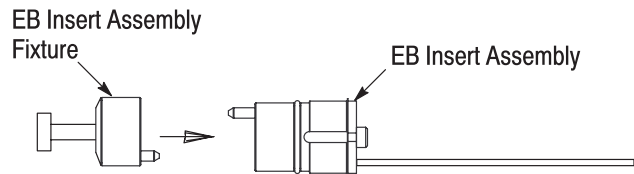
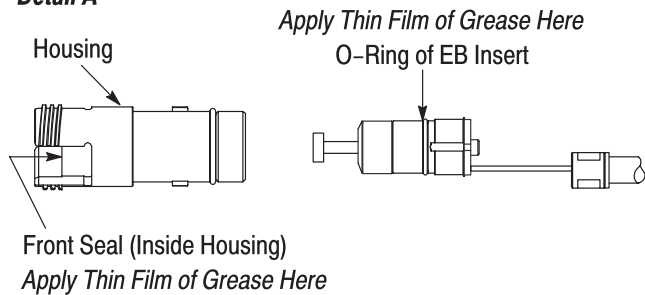
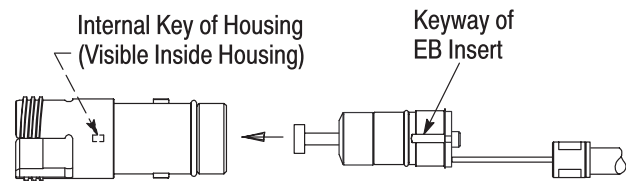

Figure 12

Detail A



Detail B



Detail C

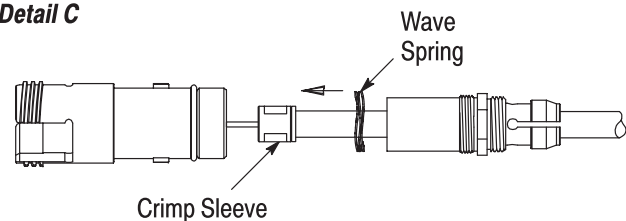

Figure 13



12. Apply 2 to 3 drops of the threadlocker to the threads at the front of the collet sleeve. See Figure 14, Detail A.

13. Slide the collet sleeve over the crimp sleeve and into the housing. Thread the collet sleeve onto the housing, BEING VERY CAREFUL NOT to pinch the back end of the collet sleeve which would cause the cable to twist. See Figure 14, Detail B.

14. Secure the bench-mount assembly fixture to a stable work surface. Fit the end of the housing onto the captive housing of the bench-mount assembly fixture. See Figure 14, Detail C.

15. Using 15-mm U-wrench, tighten the collet sleeve to a torque between 4 and 5 N-m.

16. Using an applicator swab, apply a *thin film* of the grease to the housing O-ring, threads of the collet sleeve, and the ramp of the collet sleeve. Refer to Figure 14, Detail D.

17. Slide the collet nut onto the collet sleeve. See Figure 14, Detail E. Using the 15-mm U-wrench, tighten the collet nut to a torque between 3.6 and 4 N-m.

18. Apply several drops of the threadlocker to the threads of the housing. See Figure 14, Detail E.

19. Slide the grip ring over the housing, twisting the grip ring  $\pm 90^\circ$  so that it slides over the O-ring and the external keys of the housing. See Figure 14, Detail F. Thread, then hand-tighten the grip ring onto the bench-mount assembly fixture.

**Detail A**

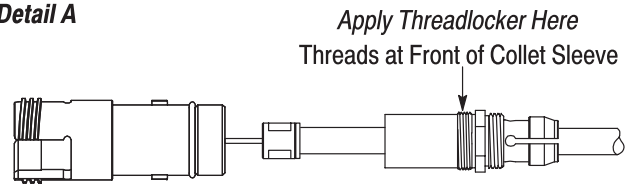

**Detail B**

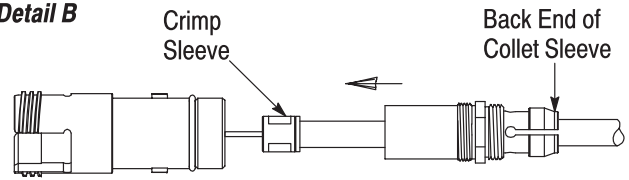

**Detail C**

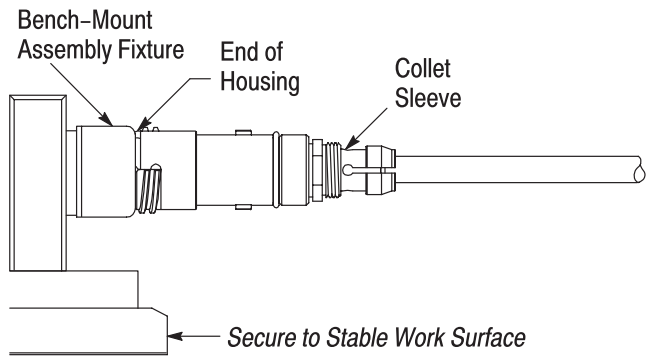

**Detail D**

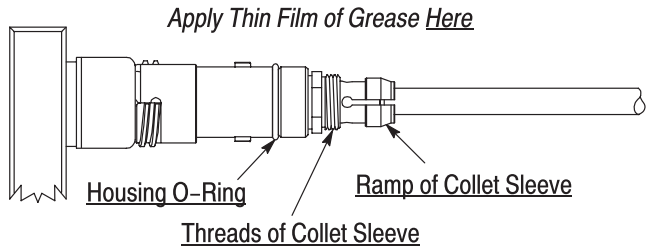

**Detail E**

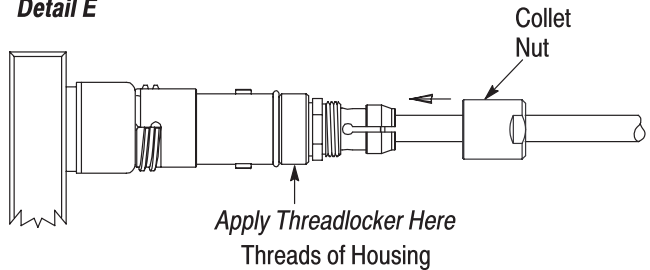

**Detail F**

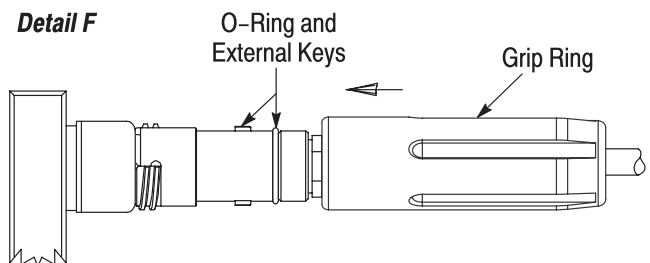

Figure 14

20. Slide the washer against the collet sleeve. See Figure 15, Detail A. Slide the cable seal over the cable until it is approximately 10 mm from the washer. See Figure 15, Detail B.

21. Apply the grease to the front and back and to the outside diameter of the cable seal. Also, apply grease around the cable jacket between the cable seal and the washer. See Figure 15, Detail C.

22. Apply a *thin film* of the grease to the inside edge of the extension (this is necessary to prevent damage to the O-ring of the housing). See Figure 15, Detail C.

23. Slide the extension over the collet nut and into the grip ring. Thread, then hand-tighten the extension onto the grip ring. Using the 17-mm U-wrench, tighten the extension to a torque between 6 and 10 N-m. See Figure 15, Detail D.

24. Apply the instant adhesive completely around the cone and in the groove of the extension. See Figure 15, Detail E.

25. Slide the boot over the cone of the extension until it is tight against the shoulder of the extension. Immediately rotate the boot so that the orientation tab is aligned with a desired reference point (using the guide pin of the EB insert is recommended; facing the bench-mount assembly fixture, the guide pin is positioned at 12 o'clock). See Figure 15, Detail F.



*Make sure to use the same reference point to align the boot for subsequent connectors.*

26. Unscrew the grip ring, and remove the connector from the bench-mount assembly fixture.

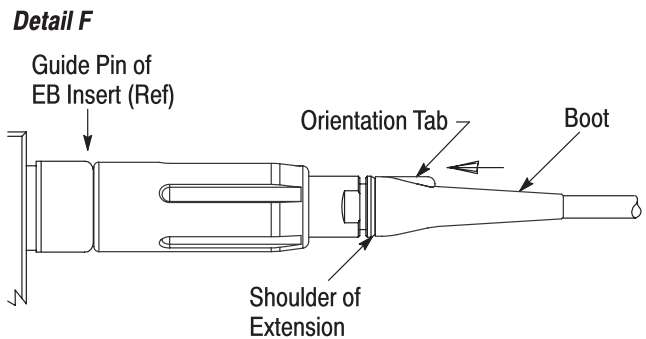
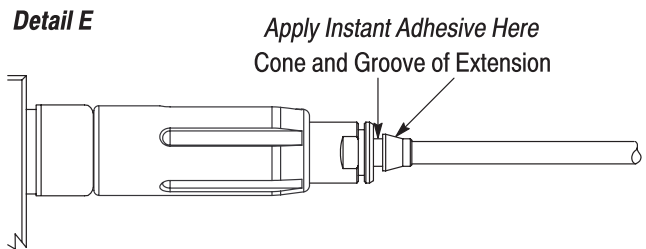
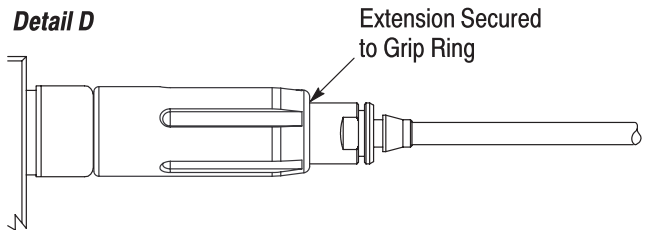
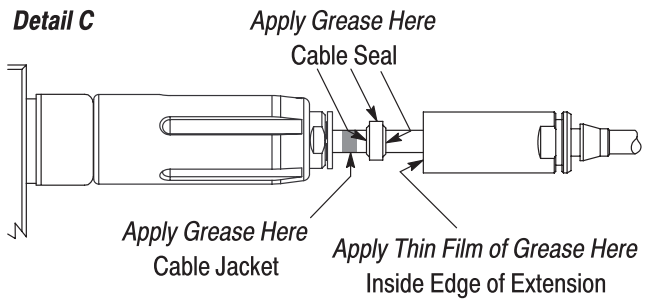
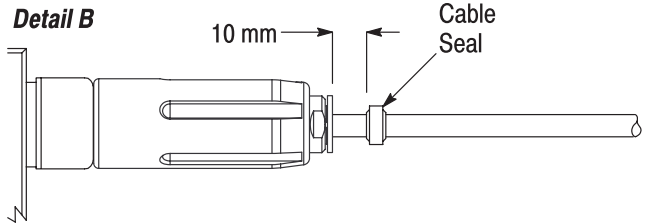
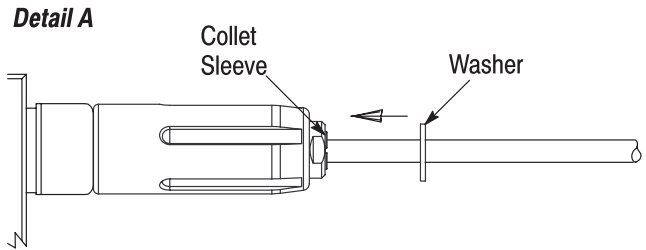

Figure 15

**5.7. Install the Protective Cap**

1. Loop the tether wire around the groove in the extension, and feed the end of the tether wire into the open end of the tether crimp sleeve. Pull approximately 3 to 5 mm of the tether wire through the tether crimp sleeve. See Figure 16, Detail A.
2. Pull the long end of the tether wire to tighten the loop (make sure that the tether crimp sleeve stays in place). Then using the crimping tool and the 4-mm hex nest, crimp the tether crimp sleeve onto the tether wire.
3. Slide the shrink tube over the tether crimp sleeve until it hangs over the top of the crimp sleeve by 1 mm. See Figure 16, Detail B.
4. Using the heat gun, and starting at the top of the shrink tube, apply heat to the shrink tube until it shrinks evenly and is secure. Thread the protective cap onto the grip ring. Finger-tighten the cap. See Figure 16, Detail C.
5. Thread the protective cap onto the grip ring, then finger-tighten the cap as shown in Figure 16, Detail C.

**6. REPLACEMENT AND REPAIR**

Components are not repairable. DO NOT use any damaged or defective components. DO NOT re-use the crimp support, crimp sleeve, or ferrule assembly by removing the fiber.

Order replacement parts through your Tyco Electronics representative, or call 1-800-526-5142, or send a facsimile of your purchase order to 717-986-7605, or write to:

CUSTOMER SERVICE (038-035)  
 TYCO ELECTRONICS CORPORATION  
 PO BOX 3608  
 HARRISBURG PA 17105-3608

**7. REVISION SUMMARY**

Revisions to this instruction sheet include:

- Removed bottom call-out from Figure 5, Detail B
- Added “end of” housing to Step 14 of Paragraph 5.6

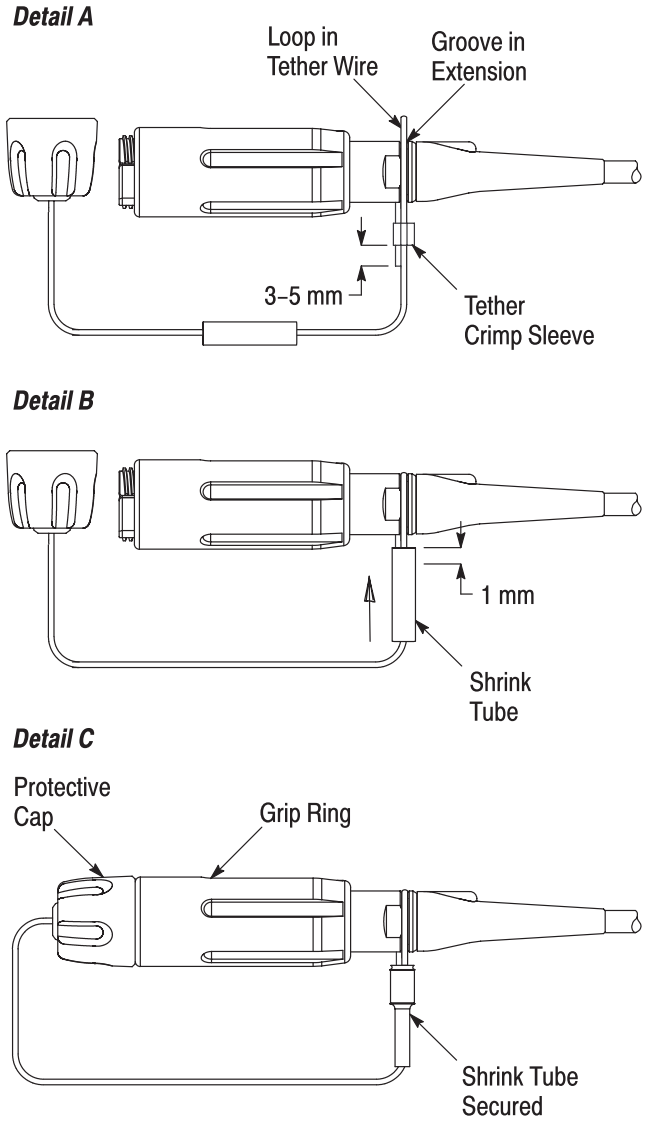

Figure 16