

Slide Switches, Low Profile, Instrumentation Grade

MATERIAL SPECIFICATIONS:

ContactsGold or silver over nickel over Cu alloy
 Frame MaterialNickel plated, Steel
 Actuator MaterialPOM 94 HB
 Terminals/Fixed Contacts.....Gold or silver over nickel over Cu alloy
 Terminal SealEpoxy

ENVIRONMENTAL SPECIFICATIONS:

Operating Temperature.....-4°F to +212°F (-20°C to +100°C)
 Storage Temperature.....-40°F to +212°F (-40°C to + 100°C)
 Solder Heat ResistanceSee page M3-4
 Recommended Cleaning.....No chlorine base or Freon can be used.
 Aqueous or 100% ethanol.

TYPICAL PERFORMANCE CHARACTERISTICS:

Contact RatingGold: 0.4 VA 20 VDC or peak AC
 Silver: 300 mA @ 125 VAC
 Initial Contact Resistance20 Milliohms max.
 Contact Timing.....Make-before-break
 Insulation Resistance1000 Megohms min.
 Dielectric Strength500 Volts RMS @ sea level
 Actuation Force50 to 450 Grams
 Actuator Travel.....0.079"-.158" (2.01-4.01)
 Life ExpectancyUp to 15,000 Cycles

B
MHS Series

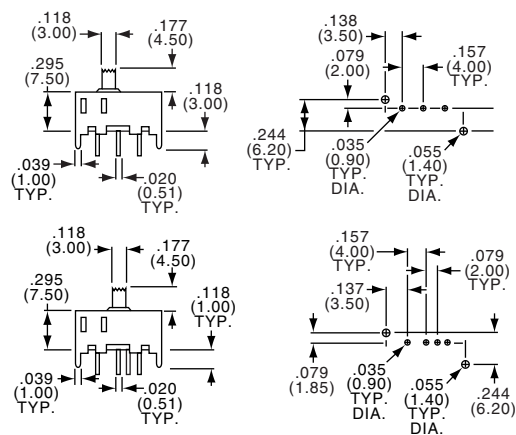
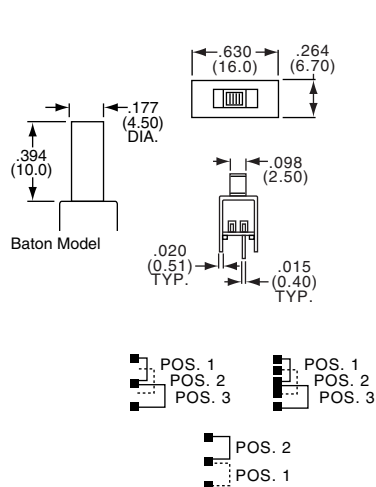

SPDT/SP3T

Standard

MHS122

Baton

MHS122K

MHS133

Standard Model Tyco Electronics	Alcoswitch	Baton Model Tyco Electronics	Alcoswitch	Type	On	None	Off	On	Contacts
1437576-9	MHS122	1-1437576-2	MHS122K	SPDT	On	None	On	On	Silver
1-1437576-5	MHS123	1-1437576-7	MHS123K	SPDT	On	Off	On	On	Silver
1-1437576-9	MHS133	2-1437576-2	MHS133K	SP3T	On	On	On	On	Silver
1-1437576-0	MHS122G	1-1437576-3	MHS122KG	SPDT	On	None	On	On	Gold
	MHS123G		MHS123KG	SPDT	On	Off	On	On	Gold
2-1437576-0	MHS133G	2-1437576-3	MHS133KG	SP3T	On	On	On	On	Gold

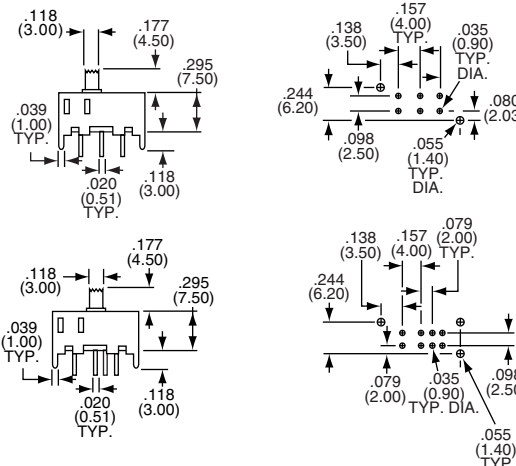
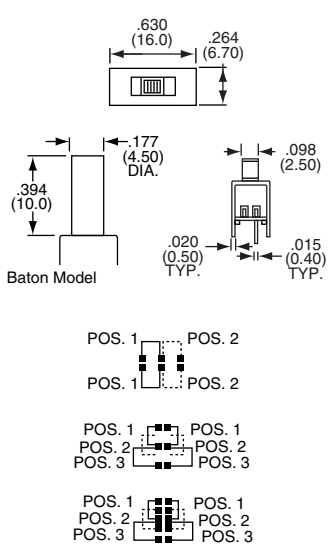

DPDT/DP3T

Standard

MHS222

MHS223

Baton

MHS222K

MHS233

Standard Model Tyco Electronics	Alcoswitch	Baton Model Tyco Electronics	Alcoswitch	Type	On	None	Off	On	Contacts
2-1437576-5	MHS222	2-1437576-8	MHS222K	DPDT	On	None	On	On	Silver
3-1437576-1	MHS223	3-1437576-4	MHS223K	DPDT	On	Off	On	On	Silver
3-1437576-6	MHS233	3-1437576-9	MHS233K	DP3T	On	On	On	On	Silver
2-1437576-6	MHS222G	2-1437576-9	MHS222KG	DPDT	On	None	On	On	Gold
3-1437576-2	MHS223G	—	MHS223KG	DPDT	On	Off	On	On	Gold
3-1437576-7	MHS233G	4-1437576-0	MHS233KG	DP3T	On	On	On	On	Gold

Slide Switches, Low Profile, Right Angle, Instrumentation Grade

SEE PAGE B33 FOR PRODUCT SPECIFICATIONS

B
MHS Series

SPDT/SP3T



MHS122RA



MHS133GRA

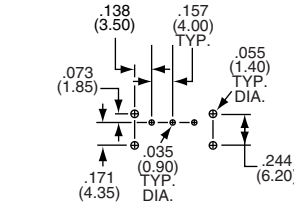
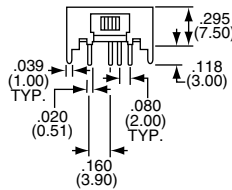
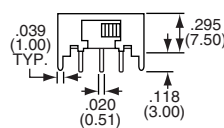
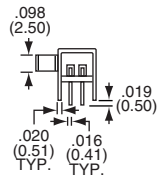
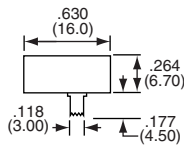

MHS122/123

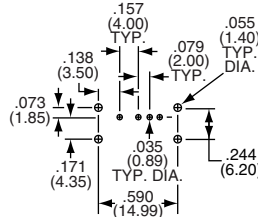

MHS133

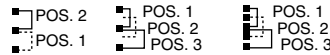

Tyco Electronics	Alcoswitch	Type				Contacts
1-1437576-4	MHS122RA	SPDT	On	None	On	Silver
1-1437576-8	MHS123RA	SPDT	On	Off	On	Silver
2-1437576-4	MHS133RA	SP3T	On	On	On	Silver
1-1437576-1	MHS122GRA	SPDT	On	None	On	Gold
1-1437576-6	MHS123GRA	SPDT	On	Off	On	Gold
2-1437576-1	MHS133GRA	SP3T	On	On	On	Gold

DPDT/DP3T



MHS222RA



MHS233GRA

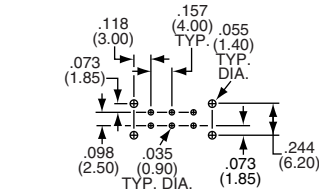
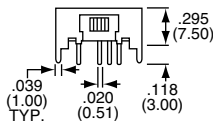
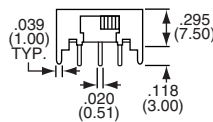
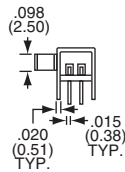
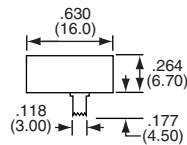

MHS222/223

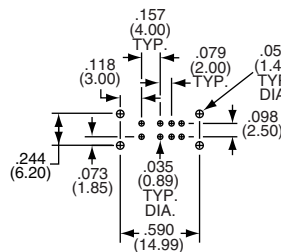

MHS233

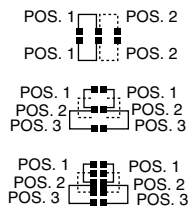

Tyco Electronics	Alcoswitch	Type				Contacts
3-1437576-0	MHS222RA	DPDT	On	None	On	Silver
3-1437576-5	MHS223RA	DPDT	On	Off	On	Silver
4-1437576-1	MHS233RA	DP3T	On	On	On	Silver
2-1437576-7	MHS222GRA	DPDT	On	None	On	Gold
3-1437576-3	MHS223GRA	DPDT	On	Off	On	Gold
3-1437576-8	MHS233GRA	DP3T	On	On	On	Gold

Slide Switches, Micro Size, Instrumentation Grade

MATERIAL SPECIFICATIONS:

ContactsSilver clad plate over copper alloy
 Cover Base MaterialPolyester
 Actuator MaterialPolyacetal
 TerminalsSilver over nickel plate over copper alloy
 Terminal SealMolded in

TYPICAL PERFORMANCE CHARACTERISTICS:

Contact Rating100 Milliamps @ 12 VDC
 Initial Contact Resistance20 Milliohms max.
 Contact TimingMake before break
 Insulation Resistance100 Megohms min.
 Dielectric Strength500 Volts RMS @ sea level
 Actuation Force250 Grams, (+200g, -150g)
 Actuator Travel.....0.079" (2.01)
 Life ExpectancyUp to 10,000 Cycles

ENVIRONMENTAL SPECIFICATIONS:

Operating Temperature.....+14°F to +140°F (-10°C to +60°C)
 Storage Temperature.....-4°F to +140°F (-20°C to +60°C)
 Solder Heat Resistance270°C+10°C, 5 seconds per MIL-STD-202, Method 210

B
SSJ Series

PCB Hole Layout

Circuit Diagram

SPDT

SSJ12

Part Number			
Tyco Electronics	Alcoswitch	Plating	Mounting Style
3-1437575-1	SSJ12	Silver	Upright

PCB Hole Layout

Circuit Diagram

SPDT

SSJ12R

Part Number			
Tyco Electronics	Alcoswitch	Plating	Mounting Style
3-1437575-2	SSJ12R	Silver	Right Angle

PCB Hole Layout

Circuit Diagram

SP3T

SSJ13

Part Number			
Tyco Electronics	Alcoswitch	Plating	Mounting Style
3-1437575-3	SSJ13	Silver	Upright

Slide Switches, Micro Size, Instrumentation Grade

MATERIAL SPECIFICATIONS:

ContactsSilver over nickel over copper alloy
 Case MaterialPolyacetal UL94HB
 Actuator MaterialPolyester UL94HB
 TerminalsSilver over nickel over copper alloy
 Terminal SealEpoxy
 Terminal Board.....UL 94 V-O

ENVIRONMENTAL SPECIFICATIONS:

Operating Temperature.....+14°F to +140°F (-10°C to +60°C)
 Storage Temperature.....+14°F to +140°F (-10°C to +60°C)
 Solder Heat Resistance.....230 ± 150 grams ± 5°C for 3 seconds per MIL-STD-202, Method 210

TYPICAL PERFORMANCE CHARACTERISTICS:

Contact Rating100 mA @ 30 VDC or peak AC
 Initial Contact Resistance30 Milliohms max.
 Contact TimingMake before break
 Insulation Resistance100 Megohms min.
 Dielectric Strength500 VAC
 Actuation Force200 ± 150 Grams
 Life ExpectancyUp to 10,000 Cycles

B
MMS Series

SPDT



MMS12

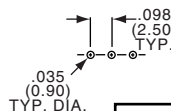
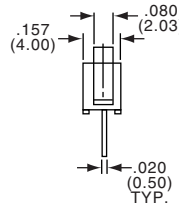
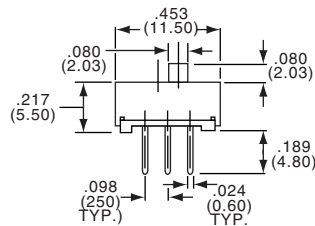

Circuit Diagram



Part Number				
Tyco Electronics	Alcoswitch	Type	Plating	Mounting Style
1437575-4	MMS12	SPDT	Silver	Upright

DPDT



MMS22

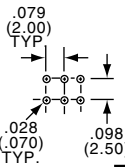
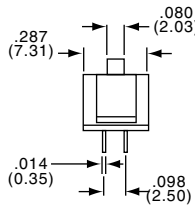
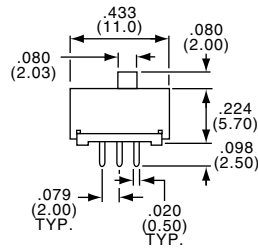

Circuit Diagram

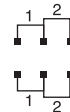

Part Number				
Tyco Electronics	Alcoswitch	Type	Plating	Mounting Style
1437575-5	MMS22	DPDT	Silver	Upright

DPDT



MMS22R

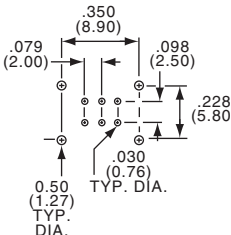
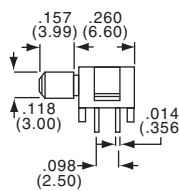
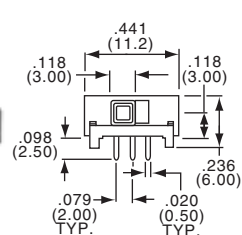

Circuit Diagram

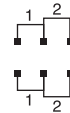

Part Number				
Tyco Electronics	Alcoswitch	Type	Plating	Mounting Style
1437575-6	MMS22R	DPDT	Silver	Right Angle

DP3T



MMS23

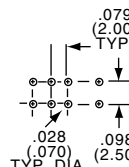
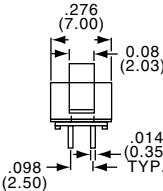
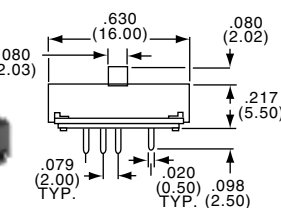

Circuit Diagram

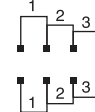

Part Number				
Tyco Electronics	Alcoswitch	Type	Plating	Mounting Style
1437575-8	MMS23	DP3T	Silver	Upright

DP3T



MMS23R

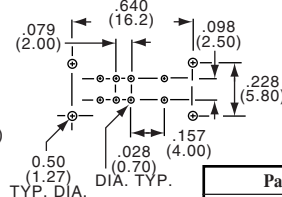
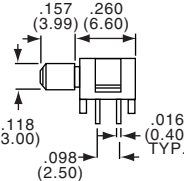
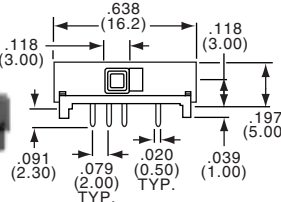

Circuit Diagram

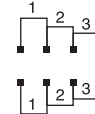

Part Number				
Tyco Electronics	Alcoswitch	Type	Plating	Mounting Style
1437575-9	MMS23R	DP3T	Silver	Right Angle

Slide Switches, Micro Size, Instrumentation Grade

SEE PAGE B36 FOR PRODUCT SPECIFICATIONS

Circuit Diagram

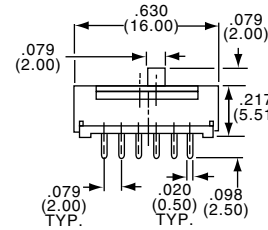
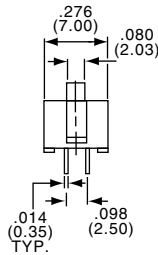
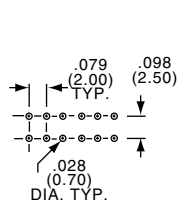
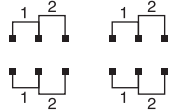

4PDT

MMS42

Part Number				
Tyco Electronics	Alcoswitch	Type	Plating	Mounting Style
I-1437575-0	MMS42	4PDT	Silver	Upright

Circuit Diagram

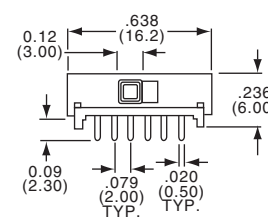
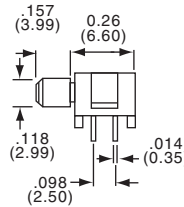
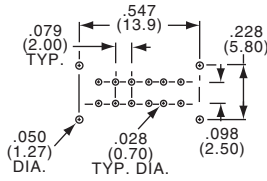
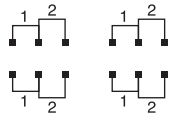

4PDT

MMS42R

Part Number				
Tyco Electronics	Alcoswitch	Type	Plating	Mounting Style
I-1437575-1	MMS42R	4PDT	Silver	Right Angle

Circuit Diagram

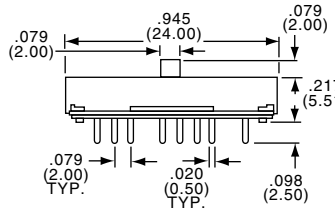
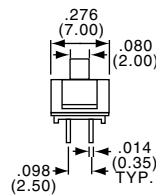
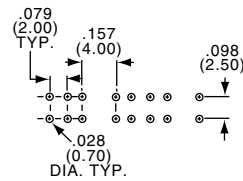
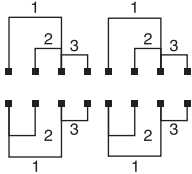

4P3T

MMS43

Part Number				
Tyco Electronics	Alcoswitch	Type	Plating	Mounting Style
I-1437575-2	MMS43	4P3T	Silver	Upright

Circuit Diagram

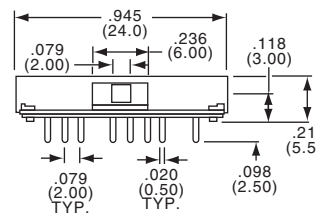
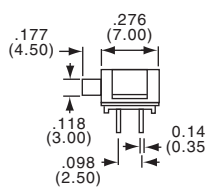
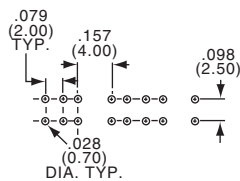
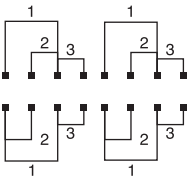

4P3T

MMS43R

Part Number				
Tyco Electronics	Alcoswitch	Type	Plating	Mounting Style
I-1437575-3	MMS43R	4P3T	Silver	Right Angle

Slide Switches, Micro Size, Instrumentation Grade

MATERIAL SPECIFICATIONS:

ContactsGold or silver plate over nickel plate
 Case MaterialSteel, tin plate
 Actuator MaterialPolyacetal UL94HB
 TerminalsGold or silver plate over nickel plate
 Terminal SealEpoxy

ENVIRONMENTAL SPECIFICATIONS:

Operating Temperature.....-4°F to +176°F (-20°C to +80°C)
 Storage Temperature.....-40°F to +212°F (-40°C to +100°C)
 Solder Heat Resistance.....+260°C (+500°F) for 5 seconds
 per MIL-STD-202, Method 210

TYPICAL PERFORMANCE CHARACTERISTICS:

Contact RatingGold: 0.4 VA @ 20 VDC or peak AC
 Silver: 100 mA @ 30 VDC
 Initial Contact Resistance.....30 Milliohms max.
 Contact Timing.....Make before break
 Insulation Resistance100 Megohms min.
 Dielectric Strength500 VAC
 Actuation Force250 ± 150 Grams
 Life ExpectancyUp to 10,000 Cycles
 Travel0.079" (2.01)

SPDT



SSB12

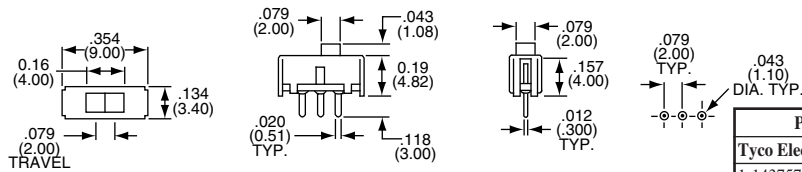

Circuit Diagram



Part Number				
Tyco Electronics	Alcoswitch	Type	Plating	Mounting Style
1-1437575-8	SSB12	SPDT	Silver	Upright
1-1437575-9	SSB12G	SPDT	Gold	Upright

SPDT



SSB12R

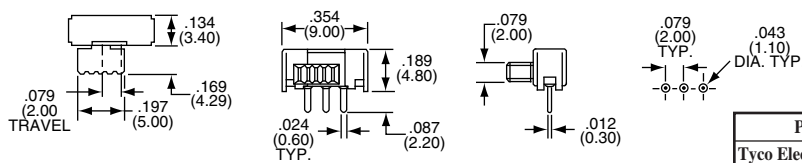

Circuit Diagram



Part Number				
Tyco Electronics	Alcoswitch	Type	Plating	Mounting Style
2-1437575-0	SSB12R	SPDT	Silver	Right Angle
2-1437575-1	SSB12RG	SPDT	Gold	Right Angle

DPDT



SSB22

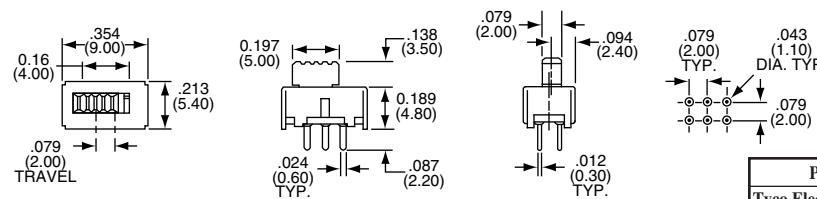

Circuit Diagram

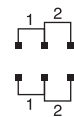

Part Number				
Tyco Electronics	Alcoswitch	Type	Plating	Mounting Style
2-1437575-2	SSB22	DPDT	Silver	Upright
2-1437575-3	SSB22G	DPDT	Gold	Upright

DPDT



SSB22R

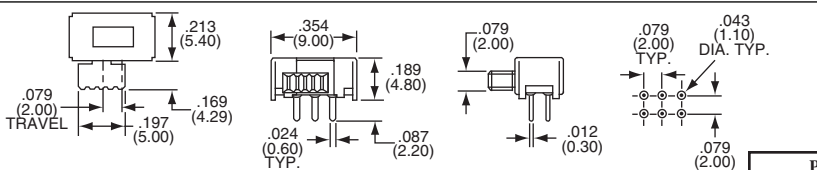

Circuit Diagram

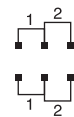

Part Number				
Tyco Electronics	Alcoswitch	Type	Plating	Mounting Style
2-1437575-4	SSB22R	DPDT	Silver	Right Angle
2-1437575-5	SSB22RG	DPDT	Gold	Right Angle

4PDT



SSB42

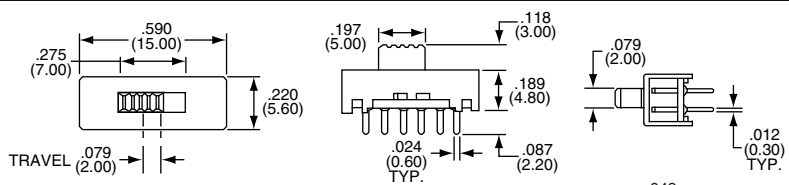

Circuit Diagram

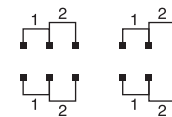

Part Number				
Tyco Electronics	Alcoswitch	Type	Plating	Mounting Style
2-1437575-8	SSB42	4PDT	Silver	Upright
2-1437575-9	SSB42G	4PDT	Gold	Upright

Slide Switches, Micro Size, Instrumentation Grade

MATERIAL SPECIFICATIONS:

ContactsSilver or gold plate
 Case MaterialPolyester PPS UL94VO
 Actuator MaterialPolyamide UL94HB
 Cover MaterialPolyamide UL94HB
 TerminalsSilver or gold plate
 Terminal SealEpoxy

ENVIRONMENTAL SPECIFICATIONS:

Operating Temperature.....-4°F to +158°F (-20°C to +70°C)
 Storage Temperature.....-40°F to +194°F (-40°C to +90°C)
 Solder Heat Resistance.....260°C (+500°F) for 5 seconds
 per MIL-STD-202, Method 210

TYPICAL PERFORMANCE CHARACTERISTICS:

Contact RatingGold: 0.4 VA max. @ 20 VDC or peak AC
 Silver: 100 Milliamps @ 30 VDC
 Initial Contact Resistance30 Milliohms max.
 Contact Timing.....Break-Before-Make
 Insulation Resistance100 Megohms min.
 Dielectric Strength500 VAC
 Actuation Force250 ± 100 Grams
 Actuator Travel.....0.098" (2.49)
 Life ExpectancyUp to 10,000 Cycles

B
SSA Series

SPDT

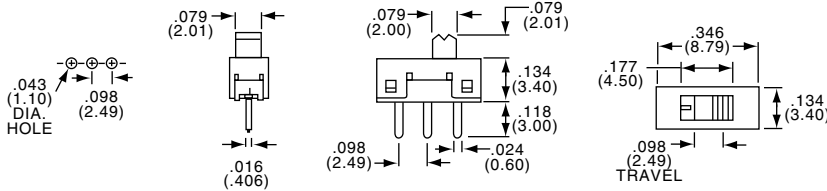

SSA12

Circuit Diagram



Part Number			
Tyco Electronics	Alcoswitch	Plating	Mounting Style
1-1437575-4	SSA12	Silver	Upright
1-1437575-5	SSA12G	Gold	Upright

DPDT

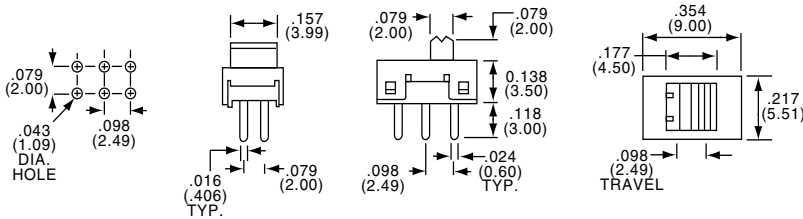

SSA22

Circuit Diagram

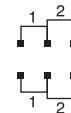

Part Number			
Tyco Electronics	Alcoswitch	Plating	Mounting Style
1-1437575-6	SSA22	Silver	Upright
1-1437575-7	SSA22G	Gold	Upright

Slide Switches, PC Tails, Wiping Contact, Consumer Grade

MATERIAL SPECIFICATIONS:

ContactsSilver plate over copper alloy
 Case MaterialSteel
 Actuator MaterialPolycarbonate
 Terminals/Fixed Contacts.....Silver plate over copper alloy
 Terminal SealEpoxy

TYPICAL PERFORMANCE CHARACTERISTICS:

Contact Rating250 mA @ 125 VAC, 150 mA @ 12 VDC
 Initial Contact Resistance30 Milliohms max.
 Contact TimingBreak before make
 Insulation Resistance500 Megohms min.
 Dielectric Strength500 VAC
 Actuation Force100-300 Grams
 Actuator Travel.....0.126" (3.20)
 Life ExpectancyUp to 10,000 Cycles

ENVIRONMENTAL SPECIFICATIONS:

Operating Temperature.....14°F to +140°F (-10°C to +60°C)
 Storage Temperature.....14°F to +140°F (-10°C to +60°C)

2 TO 6 POSITIONS

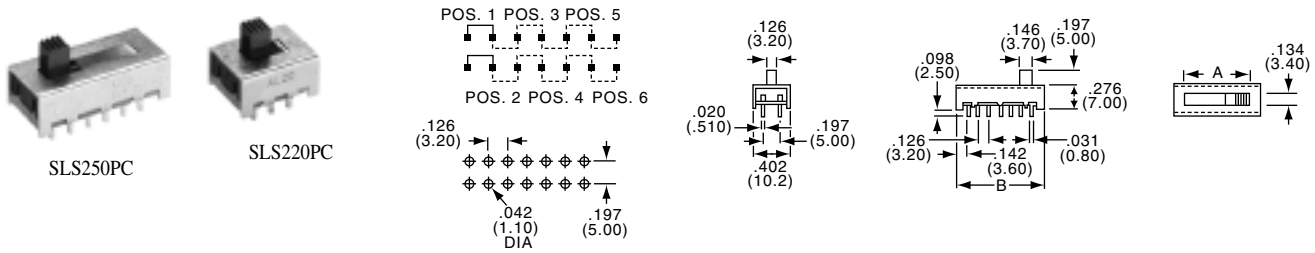

Part Number		Type	Dim.A	Dim.B
Tyco Electronics	Alcoswitch			
3-1437577-9	SLS220PC	2 Positions	.272(6.91)	.535(13.59)
4-1437577-1	SLS230PC	3 Positions	.398(10.11)	.661(16.79)
4-1437577-3	SLS240PCA	4 Positions	.524(13.31)	.787(19.99)
4-1437577-5	SLS250PC	5 Positions	.650(16.51)	.913(23.19)
4-1437577-7	SLS260PC	6 Positions	.776(19.71)	1.039(26.39)

SL Series

Slide Switches, PC Tails, Lever or Knob Actuator

2 TO 10 POSITIONS

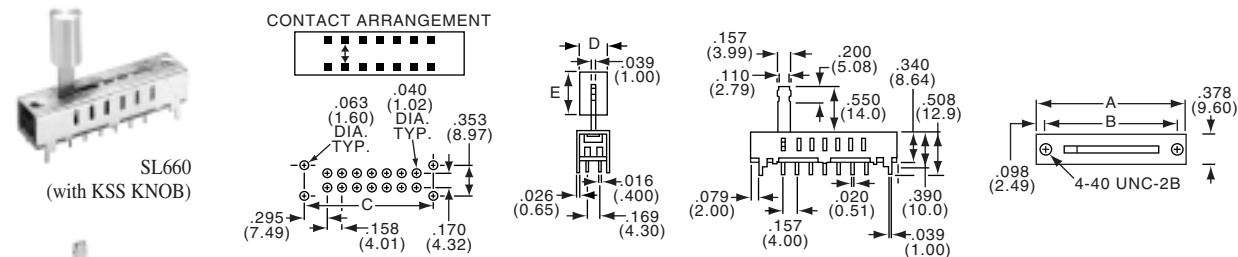

Part Number		Type	Dim. A	Dim. B	Dim. C	Knob Only	Description	Dim. D	Dim. E
Tyco Electronics	Alcoswitch								
1437577-9	SL220	2 Positions	.95(24.13)	.750(19.05)	.750(19.05)	KSS10A	Aluminum-Clear Anodize	.270(6.86)	.500(12.70)
1-1437577-0	SL330	3 Positions	1.11(28.19)	.910(23.1)	.910(23.1)	KSS10B	Aluminum-Black Anodize	.270(6.86)	.500(12.70)
1-1437577-1	SL550	5 Positions	1.42(36.07)	1.22(30.99)	1.22(31.1)	KSS20A	Aluminum-Clear Anodize	.305(7.75)	.512(13.00)
1-1437577-2	SL660	6 Positions	1.58(40.13)	1.38(35.05)	1.38(35.1)	KSS20B	Aluminum-Black Anodize	.305(7.75)	.512(13.00)
1-1437577-3	SL770	7 Positions	1.74(44.20)	1.54(39.12)	1.54(39.1)				
1-1437577-4	SL880	8 Positions	1.89(48.01)	1.70(43.18)	1.70(43.1)				
1437577-8	SL1000	10 Positions	2.21(56.13)	2.01(51.05)	2.01(51.5)				

Slide Switches, Panel Mount, Wiping Contact, Consumer Grade

MATERIAL SPECIFICATIONS:

ContactsSilver over nickel plate copper alloy
 Case MaterialSteel-zinc plated
 Actuator MaterialPBT 30% glass
 Terminals/Fixed Contacts.....Silver over nickel plate copper alloy
 Terminal SealEpoxy

ENVIRONMENTAL SPECIFICATIONS:

Operating Temperature.....-4°F to +185°F (-20°C to +85°C)
 Storage Temperature.....-40°F to +212°F (-40°C to +100°C)
 Solder Heat Resistance+300°C (+572°F) for 5 seconds

TYPICAL PERFORMANCE CHARACTERISTICS:

Contact Rating500 mA @ 125 VAC, 200 mA @ 12 VDC
 Initial Contact Resistance30 Milliohms max.
 Contact TimingBreak-Before-Make
 Insulation Resistance500 Megohms min.
 Dielectric Strength500 VAC
 Actuation ForceSLS: 100-300 Grams; SLSA: 220, 300 -500 Grams
 Plunger/Actuator Travel:0.106" (2.69)
 Life ExpectancyUp to 10,000 Cycles

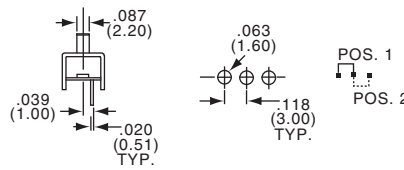
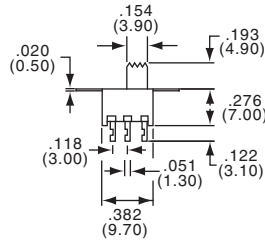
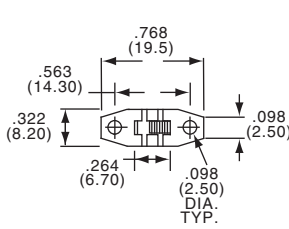

SPDT

SLS120

Part Number					
Tyco Electronics	Alcoswitch	Type	Mounting	Terminals	Contacts
1-1437577-5	SLS120	SPDT	Panel	Lug	

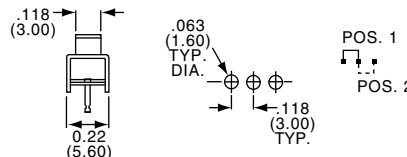
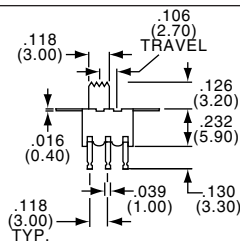
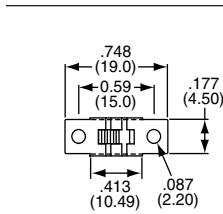

SPDT

SLSA120

Part Number					
Tyco Electronics	Alcoswitch	Type	Mounting	Terminals	Contacts
5-1437577-3	SLSA120	SPDT	Panel	Turret	

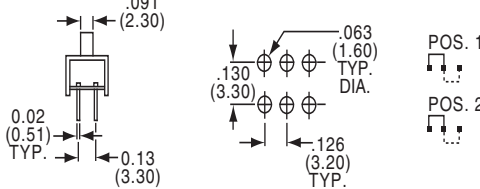
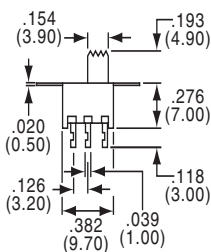
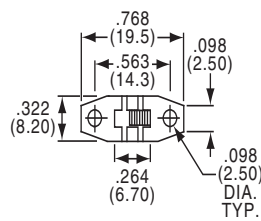

DPDT

SLS220

Part Number					
Tyco Electronics	Alcoswitch	Type	Mounting	Terminals	Contacts
3-1437577-7	SLS220	DPDT	Panel	Lug	

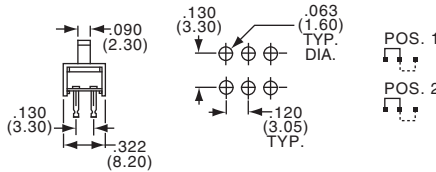
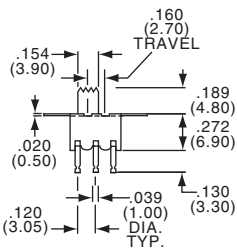
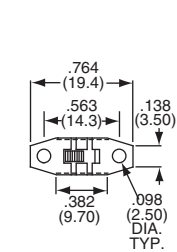

DPDT

SLSA220

Part Number					
Tyco Electronics	Alcoswitch	Type	Mounting	Terminals	Contacts
5-1437577-5	SLSA220	DPDT	Panel	Turret	

Slide Switches, Wiping Contacts, Consumer Grade

MATERIAL SPECIFICATIONS:

ContactsCopper alloy-silver/nickel
 Case MaterialSteel-zinc plate
 Actuator MaterialPBT 30% Glass
 Terminals/Fixed Contacts.....Copper, alloy, silver/nickel plate
 Terminal SealEpoxy

TYPICAL PERFORMANCE CHARACTERISTICS:

Contact Rating500 mA @ 125 VAC, 200 mA @ 12 VDC
 Initial Contact Resistance30 Milliohms max.
 Contact TimingBreak before make
 Insulation Resistance500 Megohms min.
 Dielectric Strength500 VAC
 Actuation Force350±150 Grams
 Plunger/Actuator Travel:0.106 (2.69)
 Life ExpectancyUp to 10,000 Cycles

ENVIRONMENTAL SPECIFICATIONS:

Operating Temperature.....-4°F to + 185°F (-20°C to + 85°C)
 Storage Temperature.....-40°F to + 212°F (-40°C to + 100°C)
 Solder Heat Resistance+300°C (+572°F) for 5 seconds

SPDT



Lug

SLS1201

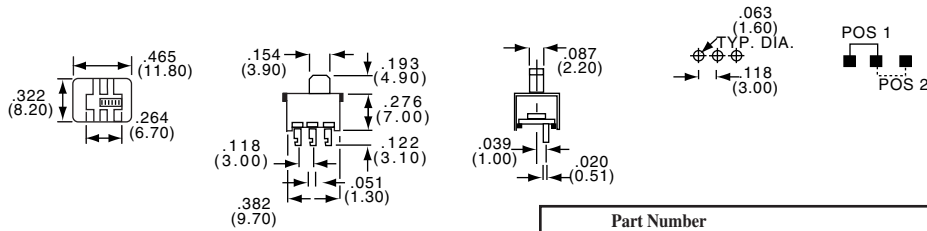

Part Number				
Tyco Electronics	Alcoswitch	Type	Mounting	Terminals Contacts
1-1437577-6	SLS1201	SPDT	PC	Lug

DPDT



Lug

SLS2201

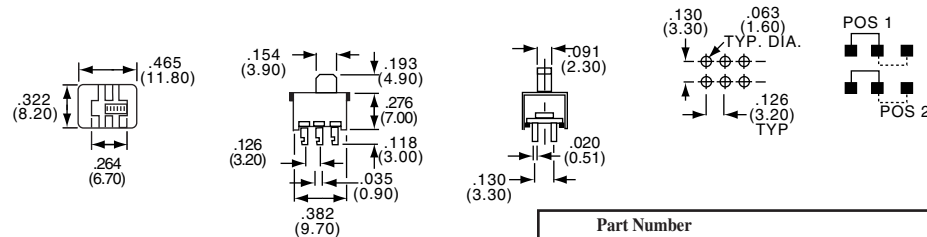

Part Number				
Tyco Electronics	Alcoswitch	Type	Mounting	Terminals Contacts
3-1437577-8	SLS2201	DPDT	PC	Lug

SPDT

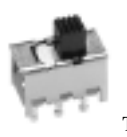

Turret

SLSA1201

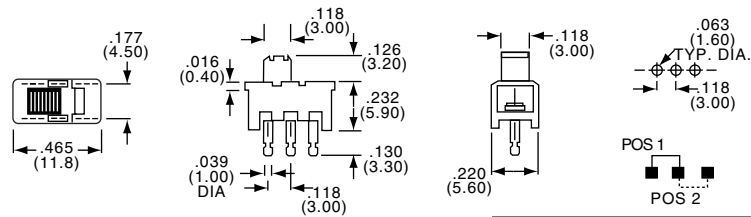

Part Number				
Tyco Electronics	Alcoswitch	Type	Mounting	Terminals Contacts
5-1437577-4	SLSA1201	SPDT	PC	Turret

DPDT



Turret

SLSA2201

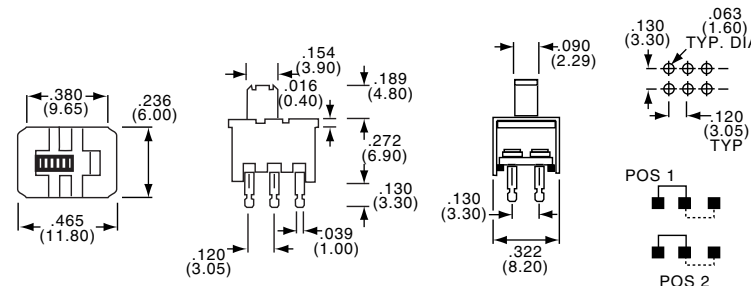

Part Number				
Tyco Electronics	Alcoswitch	Type	Mounting	Terminals Contacts
5-1437577-6	SLSA2201	DPDT	PC	Turret

B
SLS/SLSA Series

Slide Switches, Miniature, Rolling Contact, Economy Grade

MATERIAL SPECIFICATIONS:

ContactsSilver over nickel plate over copper alloy
Case MaterialTin plate over steel
Actuator MaterialPolycarbonate
Terminals/Fixed Contacts.....Silver over nickel plate over copper alloy

TYPICAL PERFORMANCE CHARACTERISTICS:

Contact Rating250 mA @ 125 VAC, 150 mA @ 12 VDC
Initial Contact Resistance30 Milliohms max.
Contact TimingBreak before make
Insulation Resistance500 Megohms min.
Dielectric Strength500 VAC
Actuation Force340 ± 57 Grams
Actuator Travel.....0.126" (3.20)
Life ExpectancyUp to 6,000 to 10,000 Cycles

ENVIRONMENTAL SPECIFICATIONS:

Operating Temperature.....14°F to +185°F (-10°C to +85°C)
Storage Temperature.....14°F to +185°F (-10°C to +85°C)

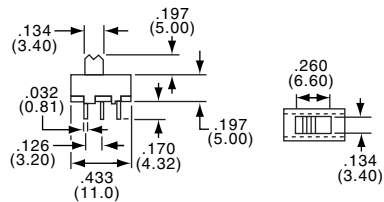
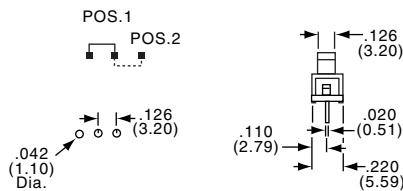

SLS121PC

Part Number		
Tyco Electronics	Alcoswitch	Mounting Style
1-1437577-9	SLS121PC	Printed Circuit

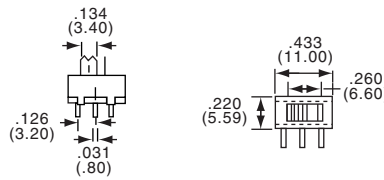
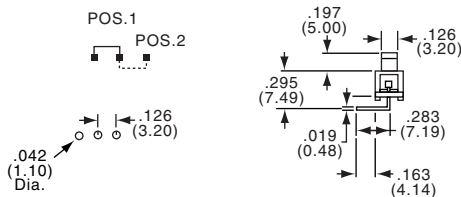

SLS121RA

Part Number		
Tyco Electronics	Alcoswitch	Mounting Style
2-1437577-2	SLS121RA	Right Angle PC

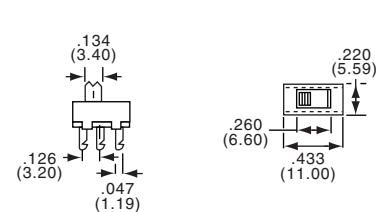
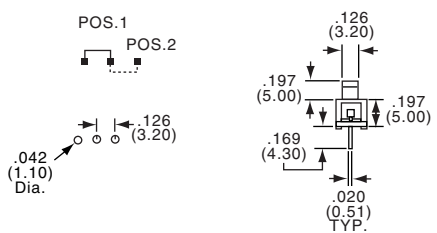

SLS1211

Part Number		
Tyco Electronics	Alcoswitch	Mounting Style
1-1437577-8	SLS1211	Printed Circuit

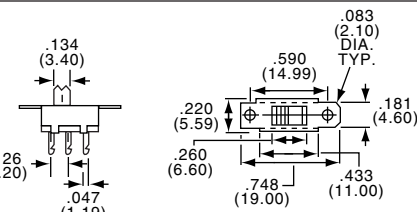
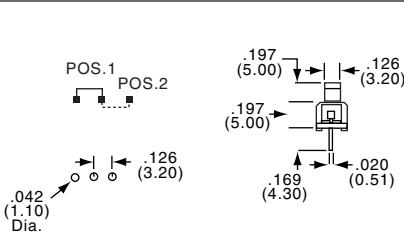

SLS121

Part Number		
Tyco Electronics	Alcoswitch	Mounting Style
1-1437577-7	SLS121	Panel Mounted

Slide Switches, Miniature, Rolling Contact, Economy Grade

MATERIAL SPECIFICATIONS:

ContactsSilver over nickel flash over copper alloy
 Case MaterialSteel
 Actuator MaterialPolycarbonate
 Terminals/Fixed Contacts.....Silver over nickel over copper alloy

ENVIRONMENTAL SPECIFICATIONS:

Operating Temperature.....+14°F to +185°F (-10°C to +85°C)
 Storage Temperature.....+14°F to +185°F (-10°C to +85°C)
 Solder Heat Resistance.....+260°C for 5 seconds

TYPICAL PERFORMANCE CHARACTERISTICS:

Contact Rating250mA @ 125 VAC
 150mA @ 12VDC
 Initial Contact Resistance20 Milliohms max.
 Contact Timing.....Break-Before-Make
 Insulation Resistance>50 Megohms.
 Dielectric Strength500 Volts RMS @ sea level
 Actuation Force340 ± 57 Grams
 Plunger/Actuator Travel:0.260" to 0.512" (6.60-13.00)
 Life ExpectancyUp to 10,000 Cycles at no load

B
SLS Series

SP3T

SLS131PC

Part Number		
Tyco Electronics	Alcoswitch	Mounting Style
2-1437577-4	SLS131PC	Printed Circuit

SP3T

SLS131RA

Part Number		
Tyco Electronics	Alcoswitch	Mounting Style
2-1437577-6	SLS131RA	Right Angle PC

SP4T

SLS141PC

Part Number		
Tyco Electronics	Alcoswitch	Mounting Style
2-1437577-8	SLS141PC	Printed Circuit

SP4T

SLS141RA

Part Number		
Tyco Electronics	Alcoswitch	Mounting Style
3-1437577-0	SLS141RA	Right Angle PC

SP5T

SLS151PC

Part Number		
Tyco Electronics	Alcoswitch	Mounting Style
3-1437577-2	SLS151PC	Printed Circuit

SP5T

SLS151RA

Part Number		
Tyco Electronics	Alcoswitch	Mounting Style
3-1437577-4	SLS151RA	Right Angle PC

Slide Switches, Baton-Toggle, Multi Pole

MATERIAL SPECIFICATIONS:

ContactsSilver clad over nickel plated copper alloy
 Case MaterialSteel, tin plate
 Actuator MaterialABS plastic/Aluminum cap
 Terminals/Fixed Contacts.....Silver over nickel plated copper alloy
 Terminal SealEpoxy

ENVIRONMENTAL SPECIFICATIONS:

Operating Temperature.....+5°F to +131°F (-15°C to +55°C)
 Storage Temperature.....-4°F to +140° F (-20°C to +60°C)
 Solder Heat Resistance.....Hand: 300°C for 3 seconds
 Wave: 250°C for 5 seconds

TYPICAL PERFORMANCE CHARACTERISTICS:

Contact Rating300 mA @ 125 VAC, 200 mA @ 12VDC
 Initial Contact Resistance20 Milliohms max.
 Contact TimingSee table below
 Insulation Resistance500 Megohms min.
 Dielectric Strength500 Volts RMS @ sea level
 Actuation Force450 ± 250 Grams
 Plunger/Actuator Travel30°
 Life ExpectancyUp to 10,000 Cycles

DPDT

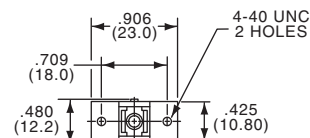
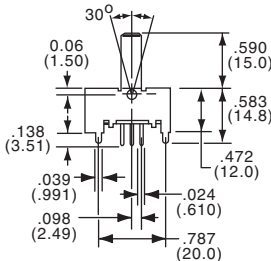
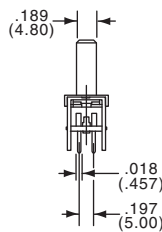
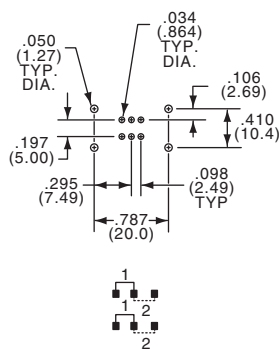

CST022NK

Part Number					Contact Timing
Tyco Electronics	Alcoswitch				
1437576-2	CST022NK	None	On	On	Non Shorting - Break-Before-Make (On) indicates momentary position.

DP3T

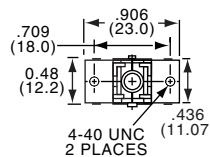
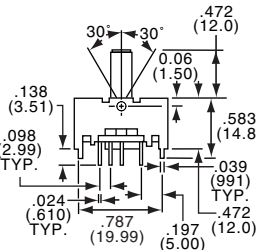
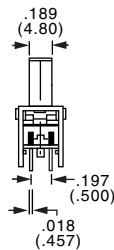
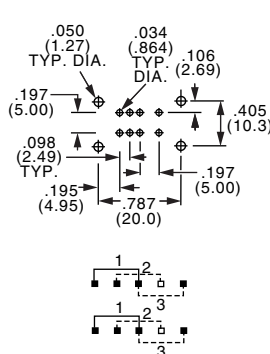

CST023NK

Part Number					Contact Timing
Tyco Electronics	Alcoswitch				
1437576-4	CST023NK	On	On	On	Non Shorting

Slide Switches, Baton-Toggle, Multi Pole

SEE PAGE B45 FOR PRODUCT SPECIFICATIONS

B
CST Series

4PDT

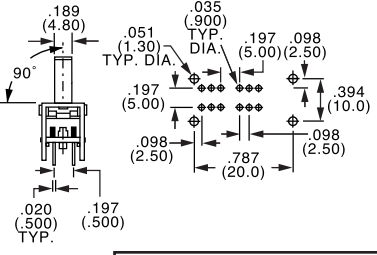
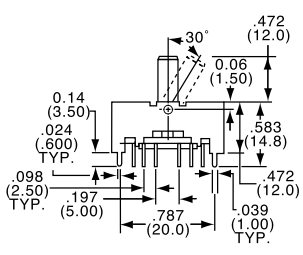
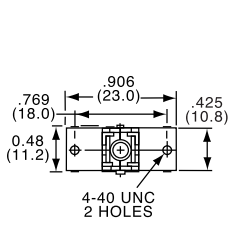

Circuit Diagram

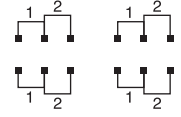

CST042NK

Part Number					
Tyco Electronics	Alcoswitch				Contact Timing
1437576-5	CST042NK	None	On	On	Non Shorting

4P3T

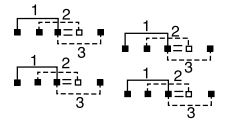
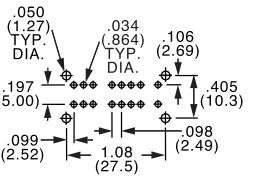
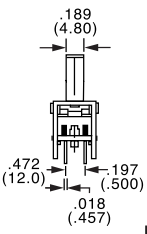
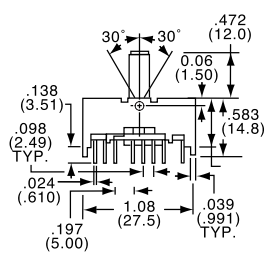
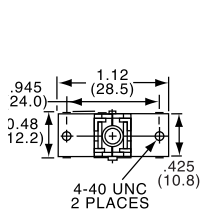

CST043NK

Part Number					
Tyco Electronics	Alcoswitch				Contact Timing
1437576-6	CST043NK	On	On	On	Non Shorting

6PDT

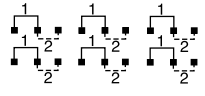
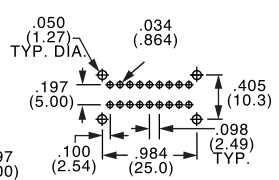
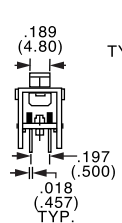
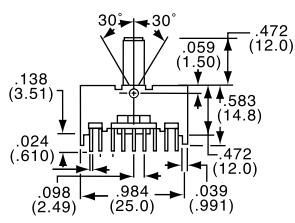
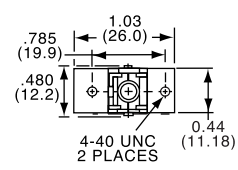

CST062NK

Part Number					
Tyco Electronics	Alcoswitch				Contact Timing
1437576-7	CST062NK	None	On	On	Non Shorting

Slide Switches, Miniature, Right Angle, Surface Mount

MATERIAL SPECIFICATIONS:

ContactsBeCu, copper alloy, 1 micron silver plate
 Case Material40% G.F. PPS, UL94V-0
 FrameStainless steel, silver plated
 Actuator MaterialNylon, UL94HB polyamide
 TerminalsBrass, copper alloy, 1 micron silver plate
 Terminal SealEpoxy

TYPICAL PERFORMANCE CHARACTERISTICS:

Contact Rating0.3 Amp, 4 VDC
 Initial Contact Resistance70 Milliohms
 Insulation Resistance100 Megohms min.
 Dielectric Strength100 VAC min.
 Actuation Force175 ±100 Grams
 Life ExpectancyUp to 10,000 Cycles
 Travel0.059 (1.5mm)

ENVIRONMENTAL SPECIFICATIONS:

HumidityMIL-STD-202, Method 103, Condition B
 Moisture ResistanceMIL-STD-202, Method 106
 Thermal ShockMIL-STD-202, Method 107, Condition A
 Solder Heat Resistance ...230°C per EIA 364-56 Level 2

SPDT

CIRCUIT DIAGRAM

MLL1200S

Part Number		
Tyco Electronics	Alcoswitch	Type
1437575-1	MLL1200S	SPDT
1437575-2	MLL1200STR	SPDT

SP3T

CIRCUIT DIAGRAM

MLL1300S

Part Number		
Tyco Electronics	Alcoswitch	Type
1437575-3	MLL1300S	SP3T