





# 10/100BASE-TX TRANSFORMER MODULES

## For Auto MDI/MDIX Applications



-  RoHS peak reflow temperature rating 245°C
-  Symmetrical transmit and receive channels for Auto MDI/MDIX capability
-  Approved for use with the Broadcom BCM5226 and Level One LXT9784
-  Meets IEEE 802.3 specification

### Electrical Specifications @ 25°C — Operating Temperature 0°C to 70°C

RoHS Compliant Part Number <sup>2</sup>	Insertion Loss (MAX)	Return Loss (dB MIN)				Crosstalk (dB MIN)				Differential to Common Mode Rejection (dBMIN)		Hipot (Vrms MIN)
		0.1-100 MHz	2-30 MHz	40 MHz	50 MHz	60-80 MHz	1 kHz	30 MHz	60 MHz	100 MHz	1-60 MHz	
H1140NL <sup>3c</sup>	-1.0	-18	-14.4	-13.1	-12	-65	-50	-40	-35	-40	-35	1500
H1141NL <sup>3c</sup>	-1.0	-18	-14.4	-13.1	-12	-65	-50	-40	-35	-40	-35	1500
H1164NL <sup>3d</sup>	-1.0	-18	-14.4	-13.1	-12	-55	-45	-40	-33	-37	-25	1500
HX1234NL <sup>1,3c</sup>	-1.4	-18	-14.4	-13.1	-12	-55	-45	-40	-33	-37	-25	1500

- Operating Temperature -40°C to +85°C C<sub>ww</sub>
- For Tape & Reel packaging, add a "T" suffix to the end of the part number when ordering, (Ex: H1164NLT)
- MSL = Moisture Sensitivity Level a=1 b=2 c=3 d=4

## Mechanicals

### H1140NL, H1164NL, HX1234NL



Weight . . . . . 4.8 grams  
Tape & Reel . . . . . 250/reel  
Tube . . . . . 15/tube

Dimensions:  $\frac{\text{Inches}}{\text{mm}}$  Unless otherwise specified, all tolerances are  $\pm \frac{.010}{0,25}$

### H1141NL

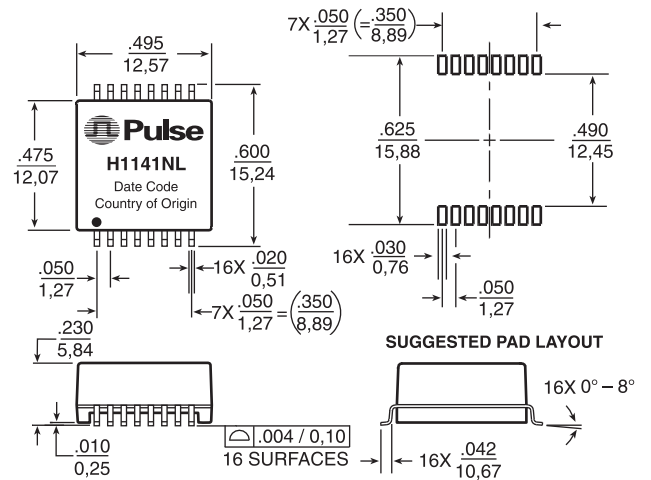

Weight . . . . . 1 gram  
Tape & Reel . . . . . 350/reel  
Tube . . . . . 35/tube

# 10/100BASE-TX TRANSFORMER MODULES

## For Auto MDI/MDIX Applications



### Schematics

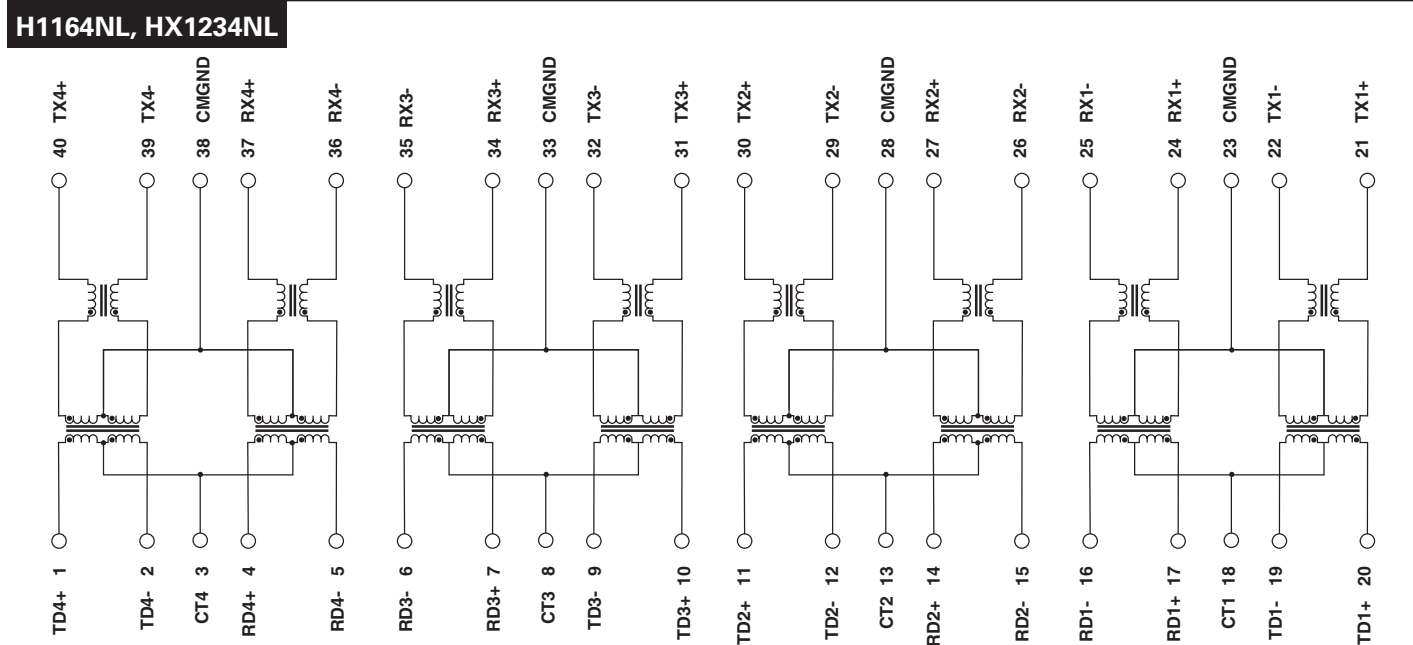
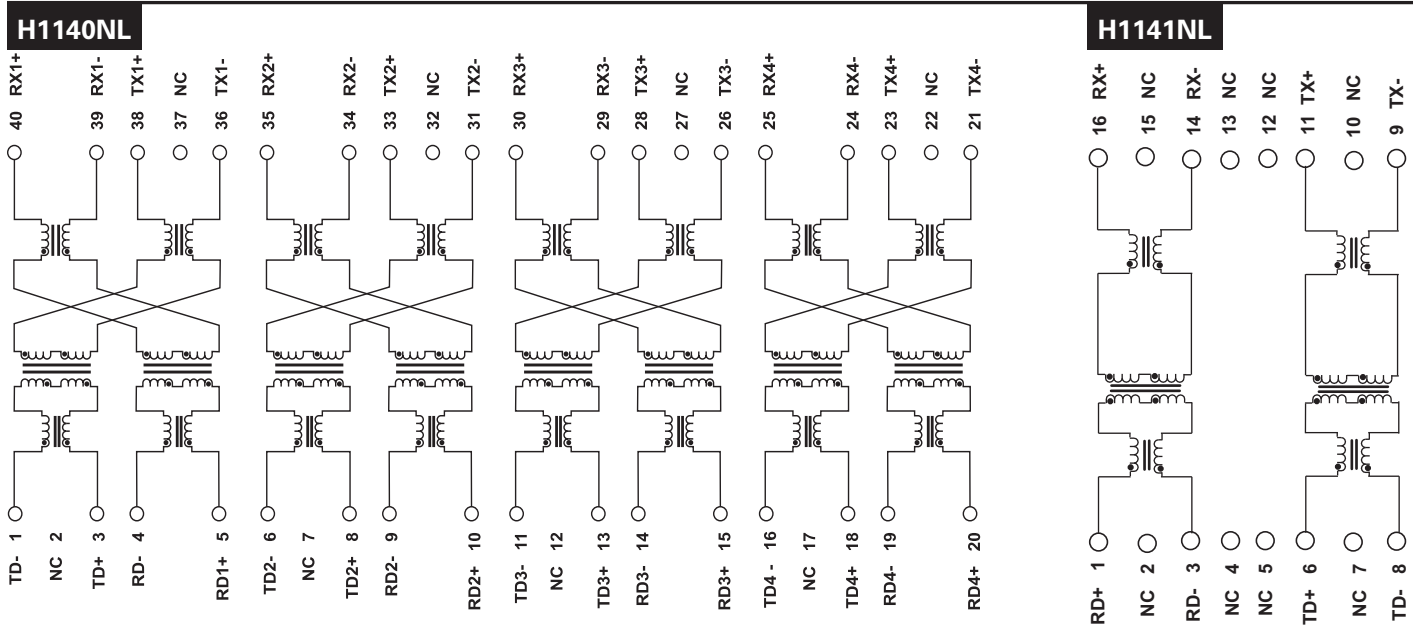

### For More Information:

**Pulse Worldwide Headquarters**  
12220 World Trade Dr.  
San Diego, CA 92128  
U.S.A.

**Pulse Europe**  
Einsteinstrasse 1  
D-71083 Herrenberg  
Germany

**Pulse China Headquarters**  
B402, Shenzhen Academy of  
Aerospace Technology Bldg.  
10th Kejinan Rd.  
High-Tech Zone  
Nanshan District  
Shenzhen, PR China 518057  
TEL: 86 755 33966678  
FAX: 86 755 33966700

**Pulse North China**  
Room 1503  
XinYin Building  
No. 888 YiShan Rd.  
Shanghai 200233  
China  
Tel: 86 21 54643211/2  
Fax: 86 21 54643210

**Pulse South Asia**  
135 Joo Seng Rd.  
#03-02  
PM Industrial Bldg.  
Singapore 368363  
TEL: 65 6287 8998  
FAX: 65 6280 0080

**Pulse North Asia**  
No. 26, Kao Ching Rd.  
Yang Mei Chen  
Taoyuan Hsien  
Taiwan  
R. O. C.  
Tel: 886 3 4643715  
Fax: 886 3 4641911

[www.pulseeng.com](http://www.pulseeng.com)  
Tel: 858 674 8100  
Fax: 858 674 8262

Performance warranty of products offered on this data sheet is limited to the parameters specified. Data is subject to change without notice. Other brand and product names mentioned herein may be trademarks or registered trademarks of their respective owners.  
© Copyright, 2009. Pulse Engineering, Inc. All rights reserved.