



# MCR08BT1

Thyristor; logic level

Rev. 03 — 29 November 2004

Product data sheet

## 1. Product profile

### 1.1 General description

Passivated, sensitive gate thyristor in a SOT223 plastic package.

### 1.2 Features

- Sensitive gate
- Surface mount package.

### 1.3 Applications

- General purpose switching and phase control
- Designed to be interfaced directly to microcontrollers, logic integrated circuits and low power gate trigger circuits.

### 1.4 Quick reference data

- $V_{DRM}, V_{RRM} \leq 200 \text{ V}$
- $I_{T(RMS)} \leq 0.8 \text{ A}$
- $I_{T(AV)} \leq 0.5 \text{ A}$
- $I_{TSM} \leq 9 \text{ A}$
- $I_{GT} = 50 \mu\text{A (typ)}$ .

## 2. Pinning information

Table 1: Pinning

Pin	Description	Simplified outline	Symbol
1	cathode	 SOT223 (SC-73)	 sym037
2	anode		
3	gate		
4	anode		

## 3. Ordering information

Table 2: Ordering information

Type number	Package		
	Name	Description	Version
MCR08BT1	SC-73	plastic surface mounted package with increased heat sink; 4 leads	SOT223

# PHILIPS

### 4. Limiting values

**Table 3: Limiting values**

In accordance with the Absolute Maximum Rating System (IEC 60134).

Symbol	Parameter	Conditions	Min	Max	Unit
$V_{DRM}, V_{RRM}$	repetitive peak off-state voltage		[1]	200	V
$I_{T(AV)}$	average on-state current	half sine wave; $T_{sp} \leq 112\text{ }^\circ\text{C}$ ; see <a href="#">Figure 1</a>	-	0.5	A
$I_{T(RMS)}$	RMS on-state current	all conduction angles; see <a href="#">Figure 4</a> and <a href="#">5</a>	-	0.8	A
$I_{TSM}$	non-repetitive peak on-state current	half sine wave; $T_j = 25\text{ }^\circ\text{C}$ prior to surge; see <a href="#">Figure 2</a> and <a href="#">3</a>			
		$t = 10\text{ ms}$	-	8	A
		$t = 8.3\text{ ms}$	-	9	A
$I^2t$	$I^2t$ for fusing	$t = 10\text{ ms}$	-	0.32	$\text{A}^2\text{s}$
$dl_T/dt$	repetitive rate of rise of on-state current after triggering	$I_{TM} = 2\text{ A}$ ; $I_G = 10\text{ mA}$ ; $dl_G/dt = 100\text{ mA}/\mu\text{s}$	-	50	$\text{A}/\mu\text{s}$
$I_{GM}$	peak gate current		-	1	A
$V_{GM}$	peak gate voltage		-	5	V
$V_{RGM}$	peak reverse gate voltage		-	5	V
$P_{GM}$	peak gate power		-	2	W
$P_{G(AV)}$	average gate power	over any 20 ms period	-	0.1	W
$T_{stg}$	storage temperature		-40	+150	$^\circ\text{C}$
$T_j$	junction temperature		-	125	$^\circ\text{C}$

[1] Although not recommended, off-state voltages up to 800 V may be applied without damage, but the thyristor may switch to the on-state. The rate of rise of current should not exceed 15 A/ $\mu\text{s}$ .

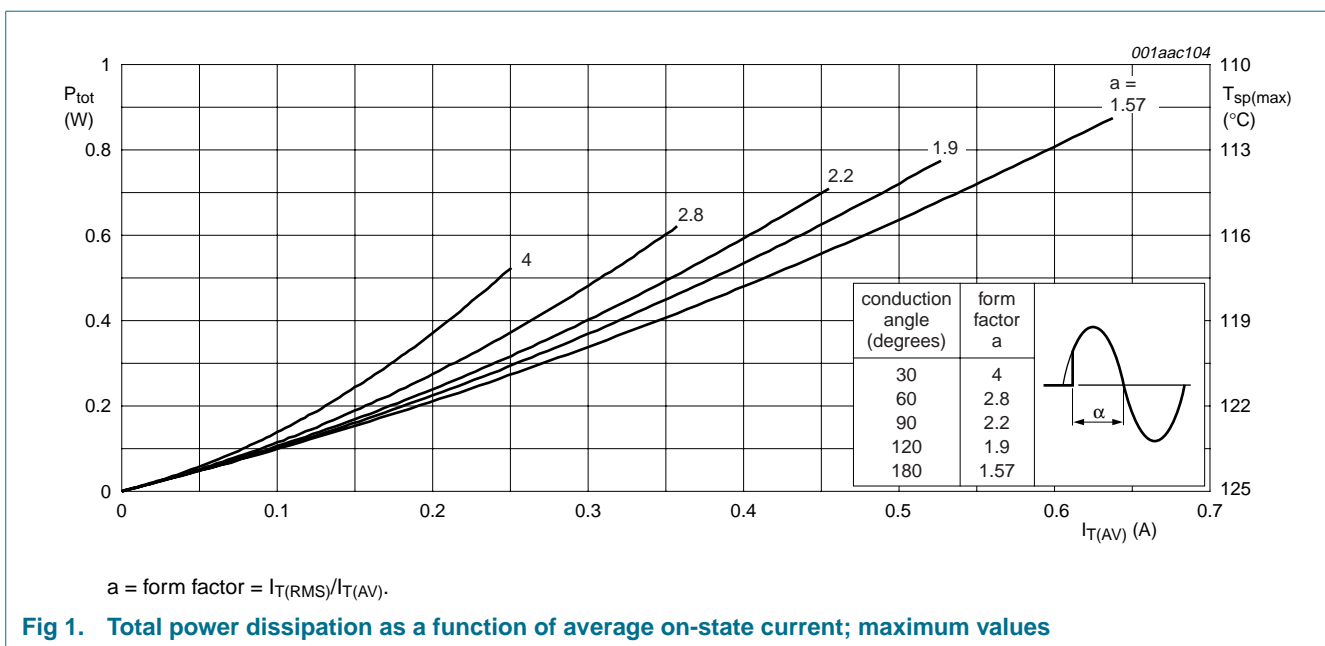

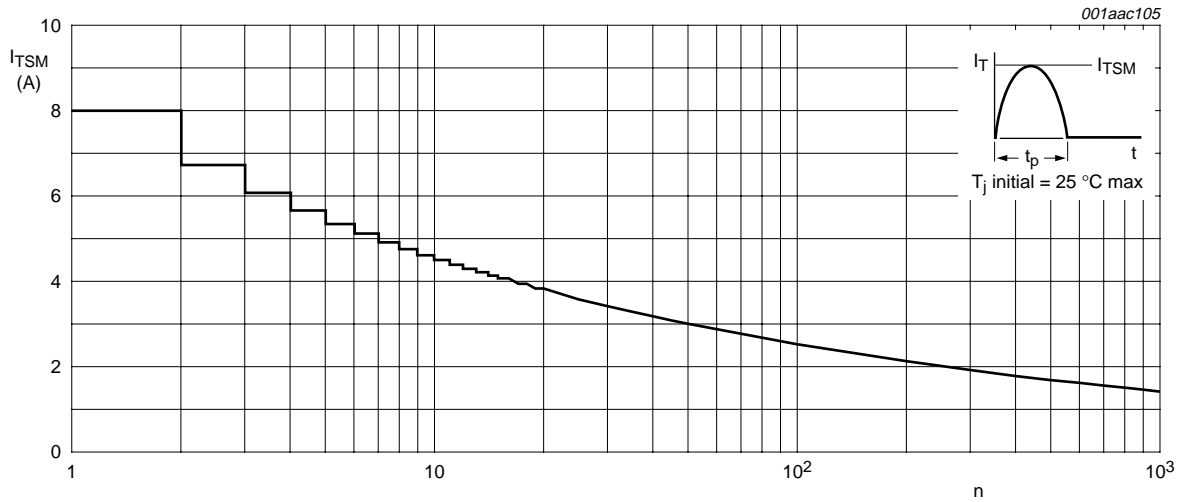

$f = 50$  Hz.

**Fig 2. Non-repetitive peak on-state current as a function of the number of sinusoidal current cycles; maximum values**

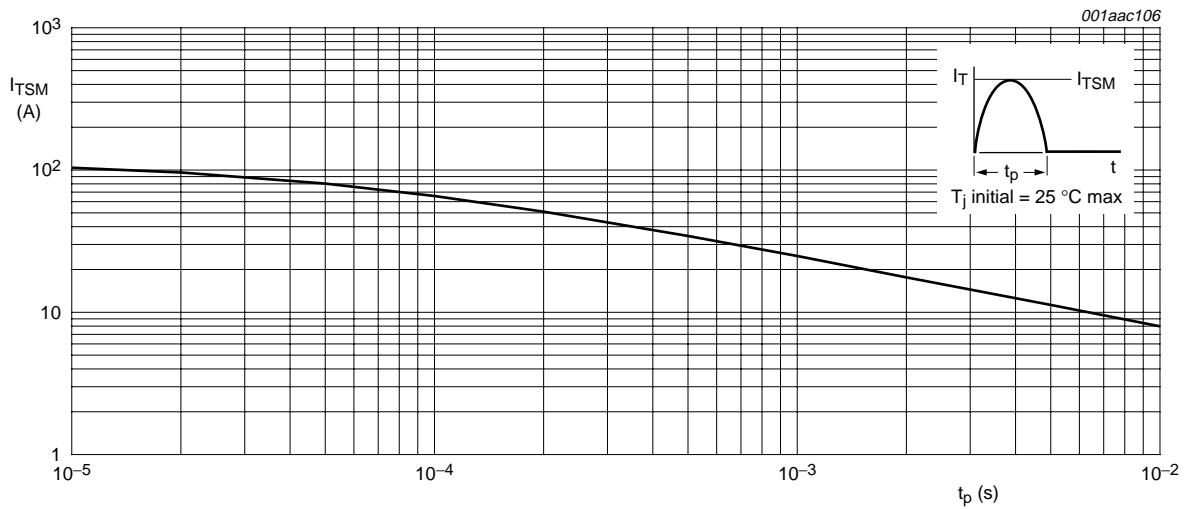

$t_p \leq 10$  ms.

**Fig 3. Non-repetitive peak on-state current as a function of pulse width for sinusoidal currents; maximum values**

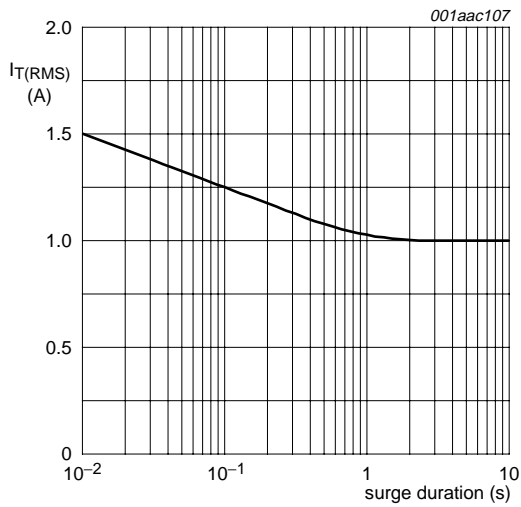

$f = 50 \text{ Hz}; T_{sp} \leq 112 \text{ }^\circ\text{C}$ .

**Fig 4.** RMS on-state current as a function of surge duration for sinusoidal currents; maximum values

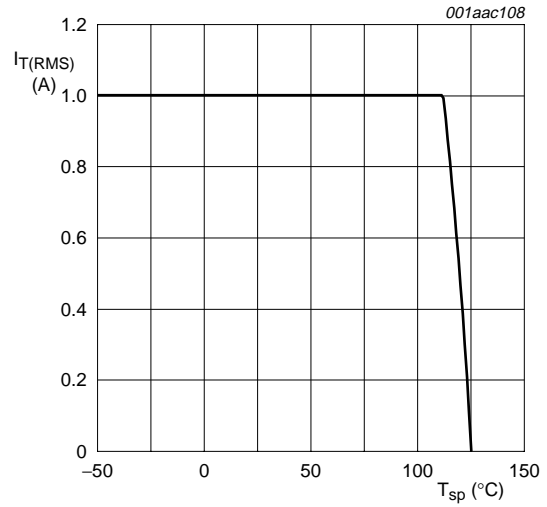

$T_{sp} = 112 \text{ }^\circ\text{C}$ .

**Fig 5.** RMS on-state current as a function of solder point temperature; maximum values

## 5. Thermal characteristics

**Table 4:** Thermal characteristics

Symbol	Parameter	Conditions	Min	Typ	Max	Unit
$R_{th(j-sp)}$	thermal resistance from junction to solder point	see <a href="#">Figure 6</a>	-	-	15	K/W
$R_{th(j-a)}$	thermal resistance from junction to ambient	printed-circuit board mounted, minimum footprint	-	156	-	K/W
		printed-circuit board mounted, pad area as in <a href="#">Figure 14</a>	-	70	-	K/W

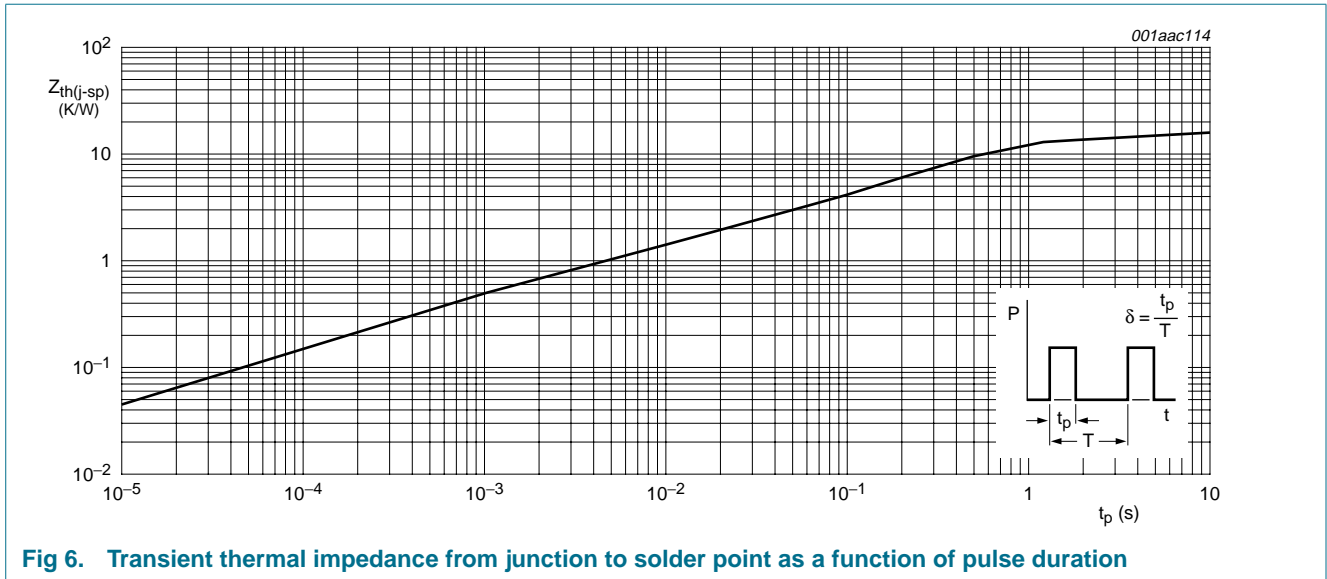

Fig 6. Transient thermal impedance from junction to solder point as a function of pulse duration

## 6. Characteristics

Table 5: Characteristics

$T_j = 25\text{ }^\circ\text{C}$  unless otherwise specified.

Symbol	Parameter	Conditions	Min	Typ	Max	Unit
<b>Static characteristics</b>						
$I_{GT}$	gate trigger current	$V_D = 12\text{ V}$ ; $I_T = 10\text{ mA}$ ; gate open circuit; see <a href="#">Figure 8</a>	-	50	200	$\mu\text{A}$
$I_L$	latching current	$V_D = 12\text{ V}$ ; $I_{GT} = 0.5\text{ mA}$ ; $R_{GK} = 1\text{ k}\Omega$ ; see <a href="#">Figure 10</a>	-	2	6	$\text{mA}$
$I_H$	holding current	$V_D = 12\text{ V}$ ; $I_{GT} = 0.5\text{ mA}$ ; $R_{GK} = 1\text{ k}\Omega$ ; see <a href="#">Figure 11</a>	-	2	5	$\text{mA}$
$V_T$	on-state voltage	$I_T = 1.2\text{ A}$ ; see <a href="#">Figure 9</a>	-	1.25	1.7	$\text{V}$
$V_{GT}$	gate trigger voltage	$I_T = 10\text{ mA}$ ; gate open circuit; see <a href="#">Figure 7</a>	-	0.5	0.8	$\text{V}$
		$V_D = 12\text{ V}$	0.2	0.3	-	$\text{V}$
$I_D$	off-state leakage current	$V_D = V_{DRM(max)}$ ; $T_j = 125\text{ }^\circ\text{C}$ ; $R_{GK} = 1\text{ k}\Omega$	-	0.05	0.1	$\text{mA}$
$I_R$	reverse current	$V_R = V_{RRM(max)}$ ; $T_j = 125\text{ }^\circ\text{C}$ ; $R_{GK} = 1\text{ k}\Omega$	-	0.05	0.1	$\text{mA}$
<b>Dynamic characteristics</b>						
$dV_D/dt$	critical rate of rise of off-state voltage	$V_{DM} = 67\% V_{DRM(max)}$ ; $T_j = 125\text{ }^\circ\text{C}$ ; exponential waveform				
		$R_{GK} = 1\text{ k}\Omega$	500	800	-	$\text{V}/\mu\text{s}$
		gate open circuit	-	25	-	$\text{V}/\mu\text{s}$
$t_{gt}$	gate controlled turn-on time	$I_{TM} = 2\text{ A}$ ; $V_D = V_{DRM(max)}$ ; $I_G = 10\text{ mA}$ ; $dI_G/dt = 0.1\text{ A}/\mu\text{s}$	-	2	-	$\mu\text{s}$
$t_q$	circuit commutated turn-off time	$V_D = 67\% V_{DRM(max)}$ ; $T_j = 125\text{ }^\circ\text{C}$ ; $I_{TM} = 1.6\text{ A}$ ; $V_R = 35\text{ V}$ ; $dI_{TM}/dt = 30\text{ A}/\mu\text{s}$ ; $dV_D/dt = 2\text{ V}/\mu\text{s}$ ; $R_{GK} = 1\text{ k}\Omega$	-	100	-	$\mu\text{s}$

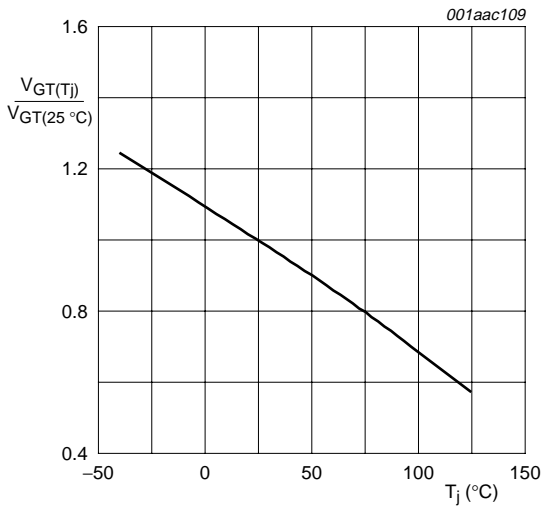

Fig 7. Normalized gate trigger voltage as a function of junction temperature.

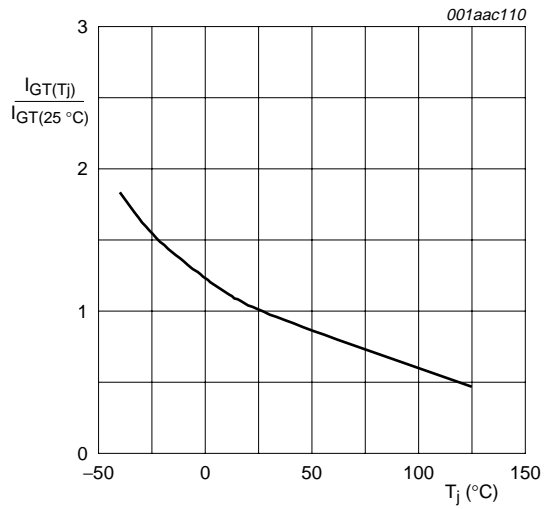
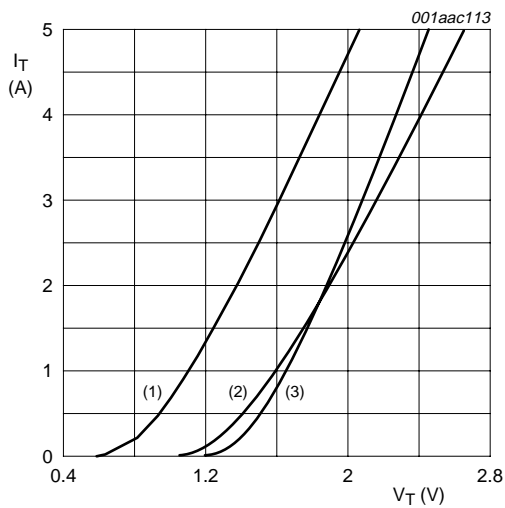

Fig 8. Normalized gate trigger current as a function of junction temperature.



$V_O = 1.0 \text{ V.}$   
 $R_S = 0.27 \Omega.$

- (1)  $T_j = 125 \text{ }^\circ\text{C};$  typical values.
- (2)  $T_j = 125 \text{ }^\circ\text{C};$  maximum values.
- (3)  $T_j = 25 \text{ }^\circ\text{C};$  maximum values.

Fig 9. On-state current characteristics.

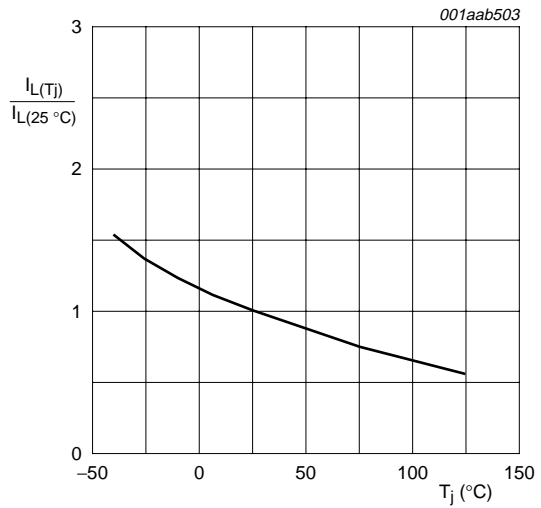

$R_{GK} = 1 \text{ k } \Omega.$

Fig 10. Normalized latching current as a function of junction temperature.

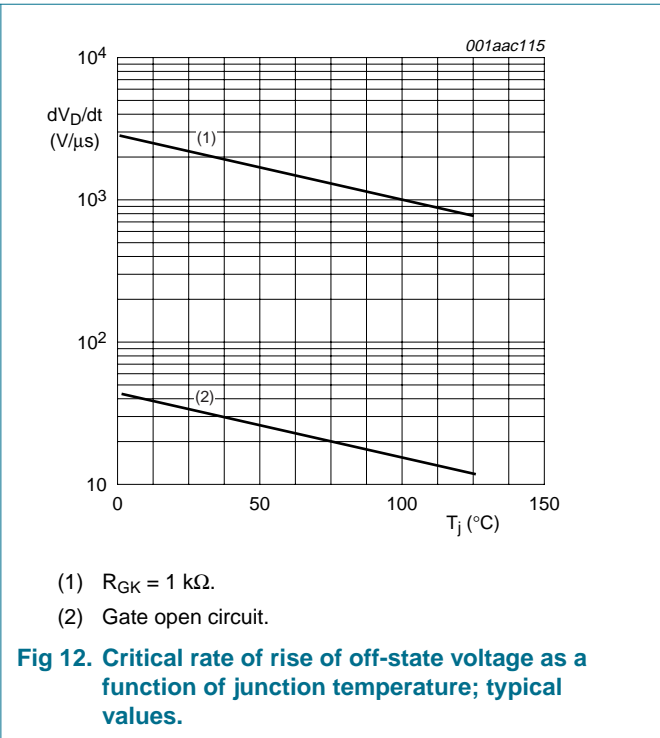
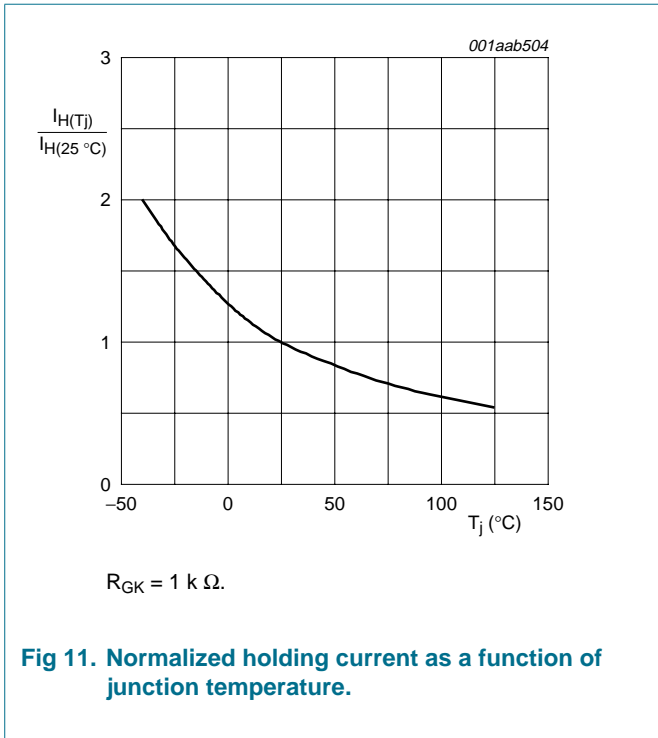

## 7. Package information

Epoxy meets requirements of UL94 V-0 at  $\frac{1}{8}$  inch.

8. Package outline

Plastic surface mounted package with increased heatsink; 4 leads

SOT223

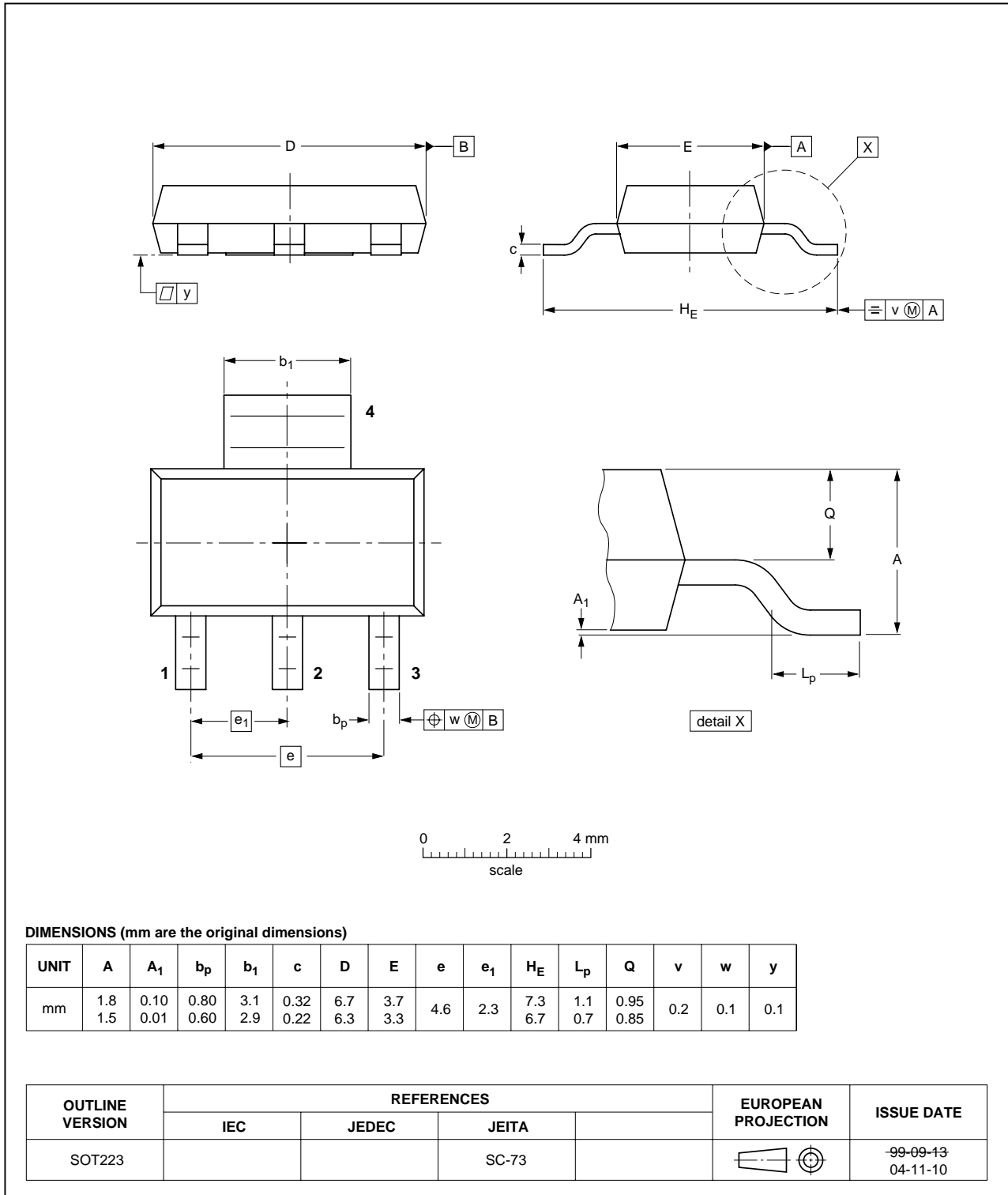
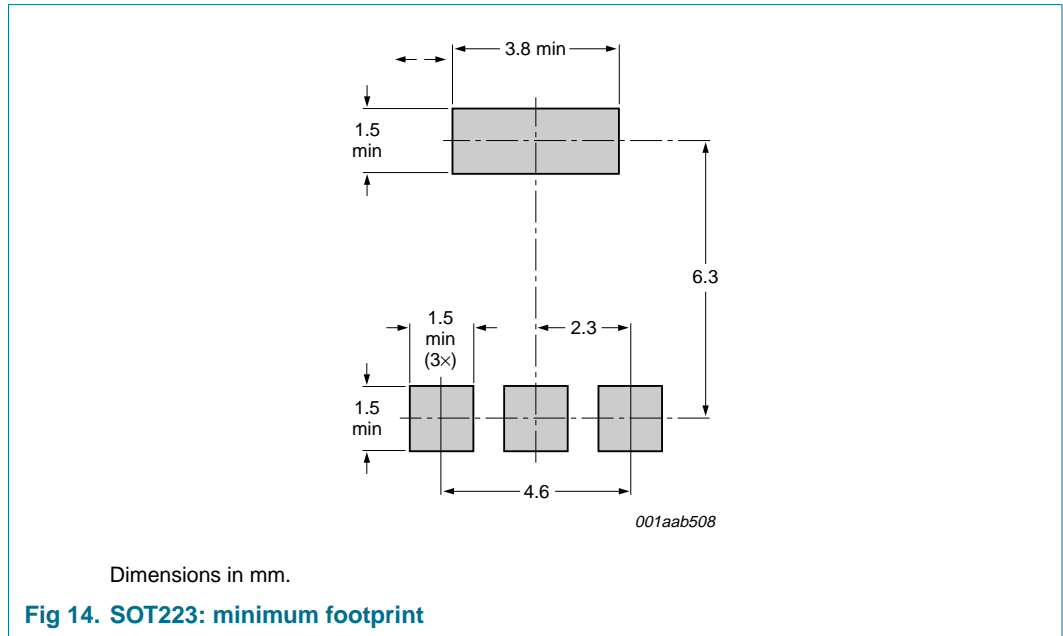

Fig 13. Package outline SOT223 (SC-73)



## 9. Mounting

### 9.1 Mounting instructions



## 10. Revision history

Table 6: Revision history

Document ID	Release date	Data sheet status	Change notice	Doc. number	Supersedes
MCR08BT1_3	20041129	Product data sheet	-	9397 750 13513	MCR08BT1_HG_2
Modifications:	<ul style="list-style-type: none"> <li>The format of this data sheet has been redesigned to comply with the new presentation and information standard of Philips Semiconductors</li> <li><a href="#">Table 5 “Characteristics”</a>: on-state voltage, changed Typ. value from 1.25 V to 1.35 V and changed Max. value from 1.5 V to 1.7 V</li> <li><a href="#">Table 5 “Characteristics”</a>: critical rate of rise of off-state voltage, added Min. value of 500 V/μs and changed Typ. value from 25 V/μs to 800 V/μs</li> <li><a href="#">Figure 9 “On-state current characteristics.”</a>: curve values changed</li> <li><a href="#">Figure 12 “Critical rate of rise of off-state voltage as a function of junction temperature; typical values.”</a>: curve values changed and ‘gate open circuit’ curve added.</li> </ul>				
MCR08BT1_HG_2	20011023	Product specification	-	9397 750 08943	MCR08BT1_1
MCR08BT1_1	20010701	Product specification	-	n.a.	-

## 11. Data sheet status

Level	Data sheet status <sup>[1]</sup>	Product status <sup>[2]</sup> <sup>[3]</sup>	Definition
I	Objective data	Development	This data sheet contains data from the objective specification for product development. Philips Semiconductors reserves the right to change the specification in any manner without notice.
II	Preliminary data	Qualification	This data sheet contains data from the preliminary specification. Supplementary data will be published at a later date. Philips Semiconductors reserves the right to change the specification without notice, in order to improve the design and supply the best possible product.
III	Product data	Production	This data sheet contains data from the product specification. Philips Semiconductors reserves the right to make changes at any time in order to improve the design, manufacturing and supply. Relevant changes will be communicated via a Customer Product/Process Change Notification (CPCN).

[1] Please consult the most recently issued data sheet before initiating or completing a design.

[2] The product status of the device(s) described in this data sheet may have changed since this data sheet was published. The latest information is available on the Internet at URL <http://www.semiconductors.philips.com>.

[3] For data sheets describing multiple type numbers, the highest-level product status determines the data sheet status.

## 12. Definitions

**Short-form specification** — The data in a short-form specification is extracted from a full data sheet with the same type number and title. For detailed information see the relevant data sheet or data handbook.

**Limiting values definition** — Limiting values given are in accordance with the Absolute Maximum Rating System (IEC 60134). Stress above one or more of the limiting values may cause permanent damage to the device. These are stress ratings only and operation of the device at these or at any other conditions above those given in the Characteristics sections of the specification is not implied. Exposure to limiting values for extended periods may affect device reliability.

**Application information** — Applications that are described herein for any of these products are for illustrative purposes only. Philips Semiconductors make no representation or warranty that such applications will be suitable for the specified use without further testing or modification.

## 13. Disclaimers

**Life support** — These products are not designed for use in life support appliances, devices, or systems where malfunction of these products can reasonably be expected to result in personal injury. Philips Semiconductors customers using or selling these products for use in such applications do so at their own risk and agree to fully indemnify Philips Semiconductors for any damages resulting from such application.

**Right to make changes** — Philips Semiconductors reserves the right to make changes in the products - including circuits, standard cells, and/or software - described or contained herein in order to improve design and/or performance. When the product is in full production (status 'Production'), relevant changes will be communicated via a Customer Product/Process Change Notification (CPCN). Philips Semiconductors assumes no responsibility or liability for the use of any of these products, conveys no license or title under any patent, copyright, or mask work right to these products, and makes no representations or warranties that these products are free from patent, copyright, or mask work right infringement, unless otherwise specified.

## 14. Contact information

For additional information, please visit: <http://www.semiconductors.philips.com>

For sales office addresses, send an email to: [sales.addresses@www.semiconductors.philips.com](mailto:sales.addresses@www.semiconductors.philips.com)

## 15. Contents

<b>1</b>	<b>Product profile</b> . . . . .	<b>1</b>
1.1	General description . . . . .	1
1.2	Features . . . . .	1
1.3	Applications . . . . .	1
1.4	Quick reference data . . . . .	1
<b>2</b>	<b>Pinning information</b> . . . . .	<b>1</b>
<b>3</b>	<b>Ordering information</b> . . . . .	<b>1</b>
<b>4</b>	<b>Limiting values</b> . . . . .	<b>2</b>
<b>5</b>	<b>Thermal characteristics</b> . . . . .	<b>4</b>
<b>6</b>	<b>Characteristics</b> . . . . .	<b>5</b>
<b>7</b>	<b>Package information</b> . . . . .	<b>7</b>
<b>8</b>	<b>Package outline</b> . . . . .	<b>8</b>
<b>9</b>	<b>Mounting</b> . . . . .	<b>9</b>
9.1	Mounting instructions . . . . .	9
<b>10</b>	<b>Revision history</b> . . . . .	<b>10</b>
<b>11</b>	<b>Data sheet status</b> . . . . .	<b>11</b>
<b>12</b>	<b>Definitions</b> . . . . .	<b>11</b>
<b>13</b>	<b>Disclaimers</b> . . . . .	<b>11</b>
<b>14</b>	<b>Contact information</b> . . . . .	<b>11</b>



© Koninklijke Philips Electronics N.V. 2004

All rights are reserved. Reproduction in whole or in part is prohibited without the prior written consent of the copyright owner. The information presented in this document does not form part of any quotation or contract, is believed to be accurate and reliable and may be changed without notice. No liability will be accepted by the publisher for any consequence of its use. Publication thereof does not convey nor imply any license under patent- or other industrial or intellectual property rights.

Date of release: 29 November 2004  
Document number: 9397 750 13513

Published in The Netherlands