

DATA SHEET

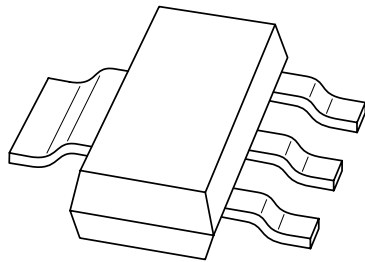

PBSS5540Z

40 V low V_{CEsat} PNP transistor

Product data sheet
Supersedes data of 2001 Jan 26

2001 Sep 21

40 V low V_{CEsat} PNP transistor

PBSS5540Z

FEATURES

- Low collector-emitter saturation voltage
- High current capability
- Improved device reliability due to reduced heat generation.

APPLICATIONS

- Supply line switching circuits
- Battery management applications
- DC/DC converter applications
- Strobe flash units
- Heavy duty battery powered equipment (motor and lamp drivers)
- MOSFET driver applications.

DESCRIPTION

PNP low V_{CEsat} transistor in a SOT223 plastic package.
NPN complement: PBSS4540Z.

MARKING

TYPE NUMBER	MARKING CODE
PBSS5540Z	PB5540

QUICK REFERENCE DATA

SYMBOL	PARAMETER	MAX	UNIT
V_{CEO}	emitter-collector voltage	-40	V
I_C	collector current (DC)	-5	A
I_{CM}	peak collector current	-10	A
R_{CEsat}	equivalent on-resistance	<80	m Ω

PINNING

PIN	DESCRIPTION
1	base
2	collector
3	emitter
4	collector

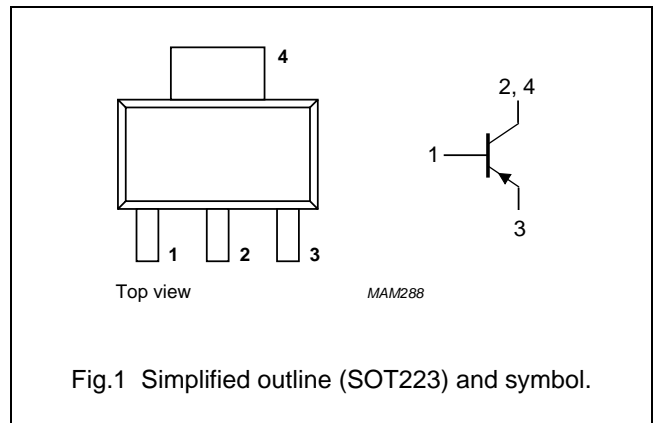

40 V low V_{CEsat} PNP transistor

PBSS5540Z

LIMITING VALUES

In accordance with the Absolute Maximum Rating System (IEC 60134).

SYMBOL	PARAMETER	CONDITIONS	MIN.	MAX.	UNIT
V_{CBO}	collector-base voltage	open emitter	–	–40	V
V_{CEO}	collector-emitter voltage	open base	–	–40	V
V_{EBO}	emitter-base voltage	open collector	–	–6	V
I_C	collector current (DC)		–	–5	A
I_{CM}	peak collector current		–	–10	A
I_{BM}	peak base current		–	–2	A
P_{tot}	total power dissipation	$T_{amb} \leq 25\text{ °C}$; note 1	–	1.35	W
		$T_{amb} \leq 25\text{ °C}$; note 2	–	2	W
T_{stg}	storage temperature		–65	+150	°C
T_j	junction temperature		–	150	°C
T_{amb}	operating ambient temperature		–65	+150	°C

Notes

1. Device mounted on a printed-circuit board, single-sided copper, tinplated, mounting pad for collector 1 cm².
2. Device mounted on a printed-circuit board, single-sided copper, tinplated, mounting pad for collector 6 cm². For other mounting conditions, see “*Thermal considerations for SOT223 in the General Part of associated Handbook*”.

THERMAL CHARACTERISTICS

SYMBOL	PARAMETER	CONDITIONS	VALUE	UNIT
$R_{th\ j-a}$	thermal resistance from junction to ambient	in free air; note 1	92	K/W

Note

1. Device mounted on a printed-circuit board, single-sided copper, tinplated, mounting pad for collector 1 cm².

40 V low V_{CEsat} PNP transistor

PBSS5540Z

CHARACTERISTICS $T_{amb} = 25\text{ °C}$ unless otherwise specified.

SYMBOL	PARAMETER	CONDITIONS	MIN.	TYP.	MAX.	UNIT
I_{CBO}	collector-base cut-off current	$V_{CB} = -30\text{ V}; I_E = 0$	–	–	–100	nA
		$V_{CB} = -30\text{ V}; I_E = 0; T_j = 150\text{ °C}$	–	–	–50	μA
I_{EBO}	emitter-base cut-off current	$V_{EB} = -5\text{ V}; I_C = 0$	–	–	–100	nA
h_{FE}	DC current gain	$V_{CE} = -2\text{ V}; I_C = -500\text{ mA}$	250	350	–	
		$V_{CE} = -2\text{ V}; I_C = -1\text{ A}; \text{note 1}$	200	300	–	
		$V_{CE} = -2\text{ V}; I_C = -2\text{ A}; \text{note 1}$	150	250	–	
		$V_{CE} = -2\text{ V}; I_C = -5\text{ A}; \text{note 1}$	50	150	–	
V_{CEsat}	collector-emitter saturation voltage	$I_C = -500\text{ mA}; I_B = -5\text{ mA}$	–	–80	–120	mV
		$I_C = -1\text{ A}; I_B = -10\text{ mA}$	–	–120	–170	mV
		$I_C = -2\text{ A}; I_B = -200\text{ mA}$	–	–110	–160	mV
R_{CEsat}	equivalent on-resistance	$I_C = -2\text{ A}; I_B = -200\text{ mA}; \text{note 1}$	–	<55	<80	$\text{m}\Omega$
V_{CEsat}	collector-emitter saturation voltage	$I_C = -5\text{ A}; I_B = -500\text{ mA}$	–	–250	–375	mV
V_{BEsat}	base-emitter saturation voltage	$I_C = -5\text{ A}; I_B = -500\text{ mA}$	–	–	–1.3	V
V_{BEon}	base-emitter turn-on voltage	$V_{CE} = -2\text{ V}; I_C = -2\text{ A}$	–	–0.8	–1.25	V
f_T	transition frequency	$I_C = -100\text{ mA}; V_{CE} = -10\text{ V}; f = 100\text{ MHz}$	60	120	–	MHz
C_c	collector capacitance	$V_{CB} = -10\text{ V}; I_E = I_e = 0; f = 1\text{ MHz}$	–	90	105	pF

Note1. Pulse test: $t_p \leq 300\text{ }\mu\text{s}$; $\delta \leq 0.02$.

40 V low V_{CEsat} PNP transistor

PBSS5540Z

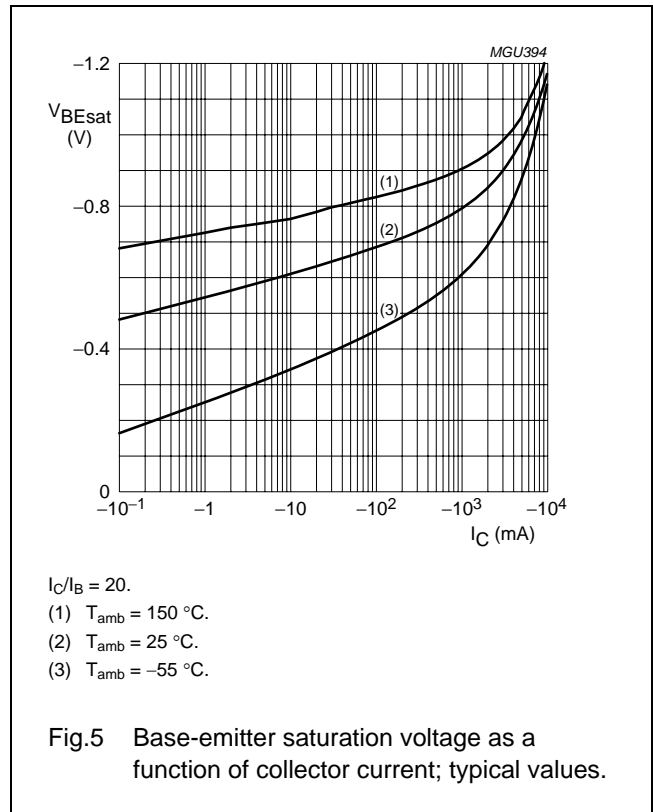
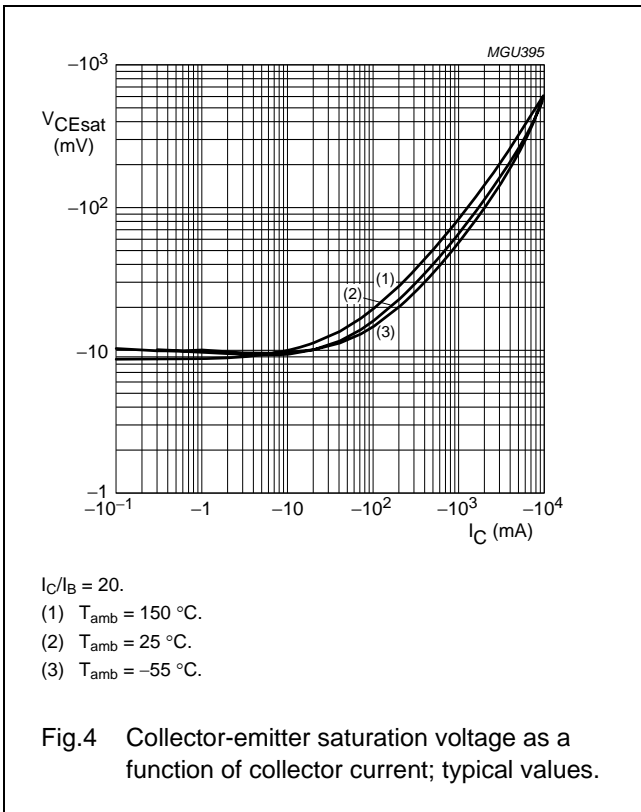
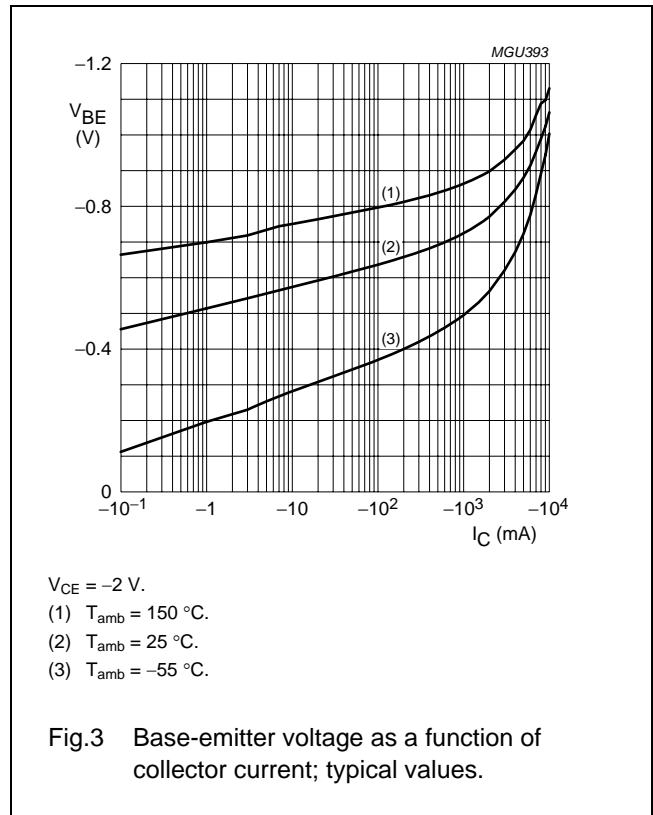
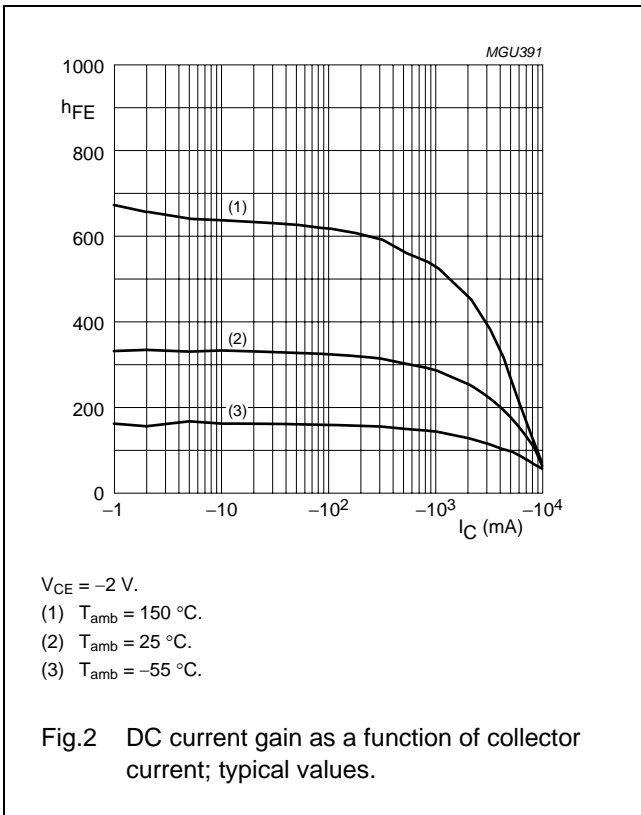

40 V low V_{CEsat} PNP transistor

PBSS5540Z

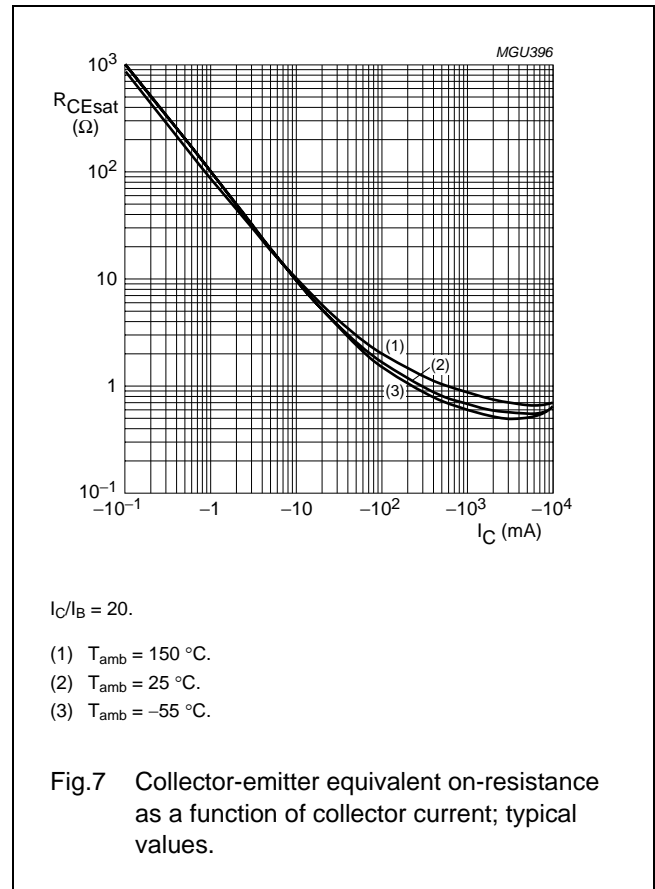
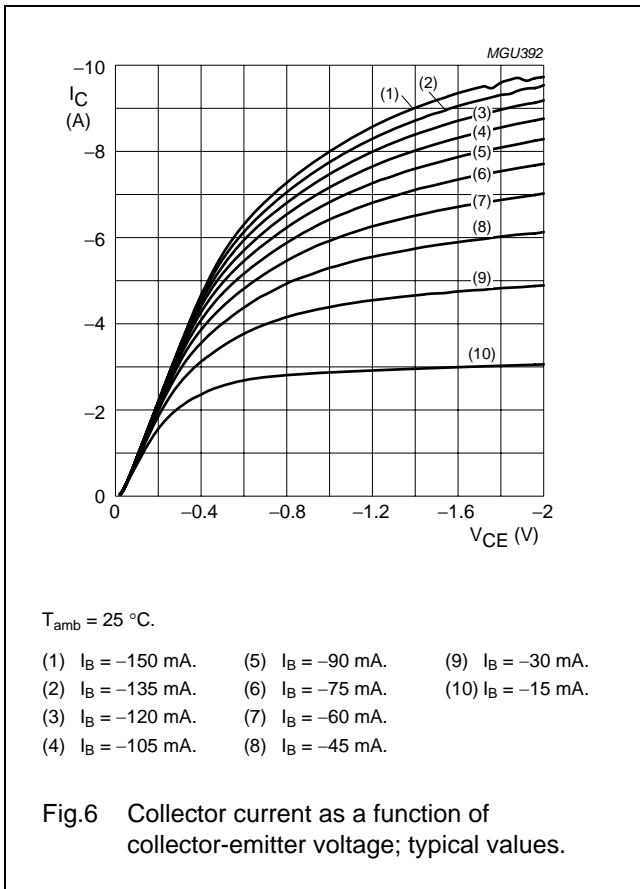

40 V low V_{CEsat} PNP transistor

PBSS5540Z

PACKAGE OUTLINE

Plastic surface mounted package; collector pad for good heat transfer; 4 leads

SOT223

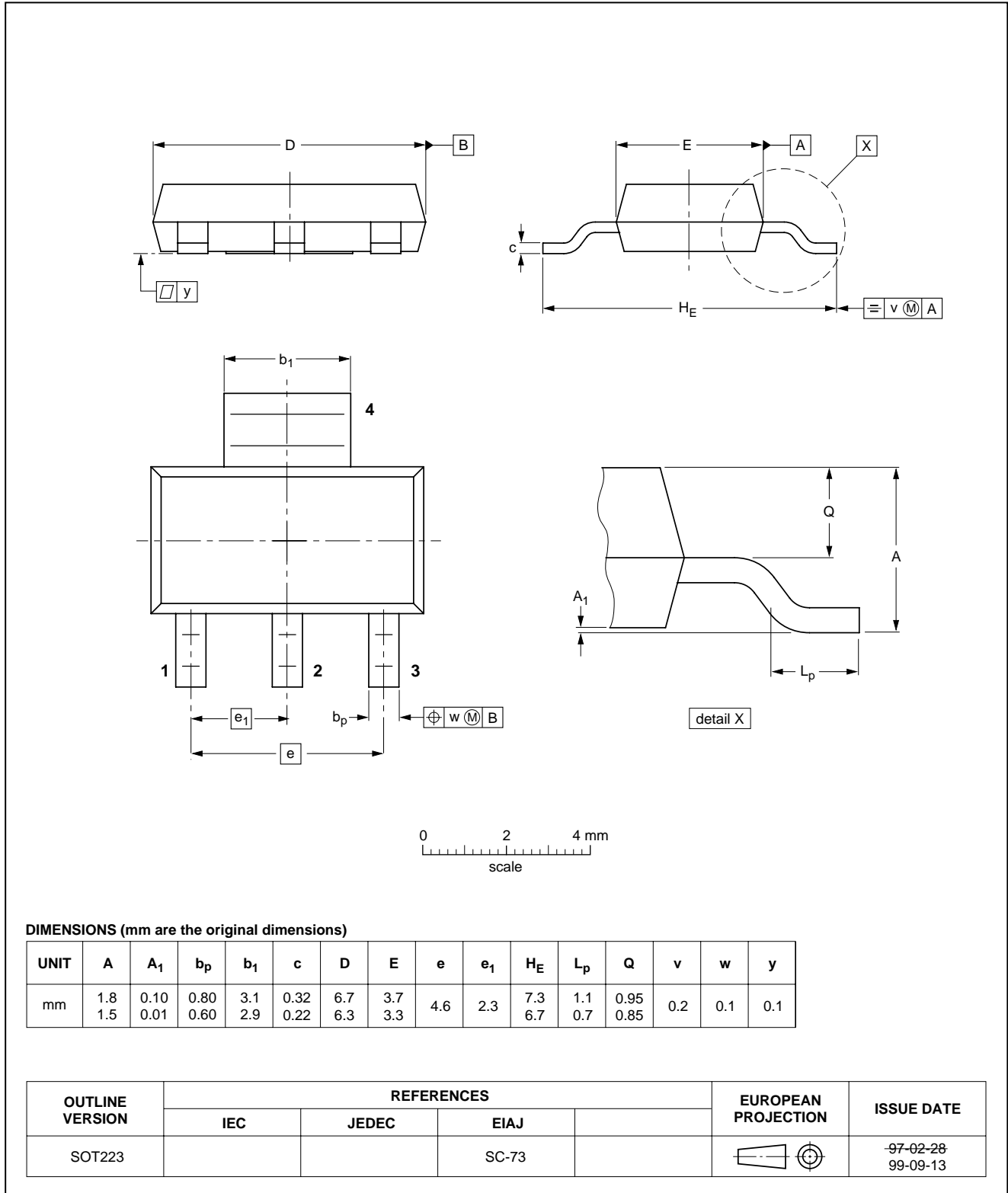

40 V low V_{CEsat} PNP transistor

PBSS5540Z

DATA SHEET STATUS

DOCUMENT STATUS ⁽¹⁾	PRODUCT STATUS ⁽²⁾	DEFINITION
Objective data sheet	Development	This document contains data from the objective specification for product development.
Preliminary data sheet	Qualification	This document contains data from the preliminary specification.
Product data sheet	Production	This document contains the product specification.

Notes

1. Please consult the most recently issued document before initiating or completing a design.
2. The product status of device(s) described in this document may have changed since this document was published and may differ in case of multiple devices. The latest product status information is available on the Internet at URL <http://www.nxp.com>.

DISCLAIMERS

General — Information in this document is believed to be accurate and reliable. However, NXP Semiconductors does not give any representations or warranties, expressed or implied, as to the accuracy or completeness of such information and shall have no liability for the consequences of use of such information.

Right to make changes — NXP Semiconductors reserves the right to make changes to information published in this document, including without limitation specifications and product descriptions, at any time and without notice. This document supersedes and replaces all information supplied prior to the publication hereof.

Suitability for use — NXP Semiconductors products are not designed, authorized or warranted to be suitable for use in medical, military, aircraft, space or life support equipment, nor in applications where failure or malfunction of an NXP Semiconductors product can reasonably be expected to result in personal injury, death or severe property or environmental damage. NXP Semiconductors accepts no liability for inclusion and/or use of NXP Semiconductors products in such equipment or applications and therefore such inclusion and/or use is at the customer's own risk.

Applications — Applications that are described herein for any of these products are for illustrative purposes only. NXP Semiconductors makes no representation or warranty that such applications will be suitable for the specified use without further testing or modification.

Limiting values — Stress above one or more limiting values (as defined in the Absolute Maximum Ratings System of IEC 60134) may cause permanent damage to the device. Limiting values are stress ratings only and operation of the device at these or any other conditions

above those given in the Characteristics sections of this document is not implied. Exposure to limiting values for extended periods may affect device reliability.

Terms and conditions of sale — NXP Semiconductors products are sold subject to the general terms and conditions of commercial sale, as published at <http://www.nxp.com/profile/terms>, including those pertaining to warranty, intellectual property rights infringement and limitation of liability, unless explicitly otherwise agreed to in writing by NXP Semiconductors. In case of any inconsistency or conflict between information in this document and such terms and conditions, the latter will prevail.

No offer to sell or license — Nothing in this document may be interpreted or construed as an offer to sell products that is open for acceptance or the grant, conveyance or implication of any license under any copyrights, patents or other industrial or intellectual property rights.

Export control — This document as well as the item(s) described herein may be subject to export control regulations. Export might require a prior authorization from national authorities.

Quick reference data — The Quick reference data is an extract of the product data given in the Limiting values and Characteristics sections of this document, and as such is not complete, exhaustive or legally binding.

NXP Semiconductors

Customer notification

This data sheet was changed to reflect the new company name NXP Semiconductors. No changes were made to the content, except for the legal definitions and disclaimers.

Contact information

For additional information please visit: <http://www.nxp.com>

For sales offices addresses send e-mail to: salesaddresses@nxp.com

© NXP B.V. 2009

All rights are reserved. Reproduction in whole or in part is prohibited without the prior written consent of the copyright owner.

The information presented in this document does not form part of any quotation or contract, is believed to be accurate and reliable and may be changed without notice. No liability will be accepted by the publisher for any consequence of its use. Publication thereof does not convey nor imply any license under patent- or other industrial or intellectual property rights.

Printed in The Netherlands

613514/04/pp9

Date of release: 2001 Sep 21

Document order number: 9397 750 08434

