

PML260SN

N-channel TrenchMOS standard level FET

Rev. 02 — 29 May 2006

Product data sheet

1. Product profile

1.1 General description

Standard level N-channel enhancement mode Field-Effect Transistor (FET) in a surface-mounted plastic package using TrenchMOS technology.

1.2 Features

- Standard level threshold
- Very low thermal impedance
- Low profile and small footprint
- Low on-state resistance

1.3 Applications

- Primary side switching
- Portable appliances
- DC-to-DC converters

1.4 Quick reference data

- $V_{DS} \leq 200$ V
- $R_{DS(on)} \leq 294$ m Ω
- $I_D \leq 8.8$ A
- $Q_{GD} = 4.2$ nC (typ)

2. Pinning information

Table 1. Pinning

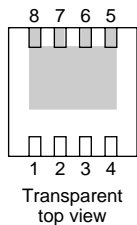
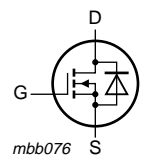
Pin	Description	Simplified outline	Symbol
1, 2, 3	source (S)	 <p>Transparent top view</p> <p>SOT873-1 (HVSON8)</p>	 <p>mbb076</p>
4	gate (G)		
5, 6, 7, 8	drain (D)		

PHILIPS

3. Ordering information

Table 2. Ordering information

Type number	Package		Version
	Name	Description	
PML260SN	HVSON8	plastic thermal enhanced very thin small outline package; no leads; 8 terminals; body 3.3 × 3.3 × 0.85 mm	SOT873-1

4. Limiting values

Table 3. Limiting values

In accordance with the Absolute Maximum Rating System (IEC 60134).

Symbol	Parameter	Conditions	Min	Max	Unit
V_{DS}	drain-source voltage	$25\text{ °C} \leq T_j \leq 150\text{ °C}$	-	200	V
V_{GS}	gate-source voltage		-	±20	V
I_D	drain current	$T_{mb} = 25\text{ °C}; V_{GS} = 10\text{ V};$ see Figure 2 and 3	-	8.8	A
		$T_{mb} = 100\text{ °C}; V_{GS} = 10\text{ V};$ see Figure 2	-	5.5	A
I_{DM}	peak drain current	$T_{mb} = 25\text{ °C};$ pulsed; $t_p \leq 10\text{ }\mu\text{s};$ see Figure 3	-	15	A
P_{tot}	total power dissipation	$T_{mb} = 25\text{ °C};$ see Figure 1	-	50	W
T_{stg}	storage temperature		-55	+150	°C
T_j	junction temperature		-55	+150	°C
Source-drain diode					
I_S	source current	$T_{mb} = 25\text{ °C}$	-	8.8	A
I_{SM}	peak source current	$T_{mb} = 25\text{ °C};$ pulsed; $t_p \leq 10\text{ }\mu\text{s}$	-	15	A
Avalanche ruggedness					
$E_{DS(AL)S}$	non-repetitive drain-source avalanche energy	unclamped inductive load; $I_D = 3.5\text{ A};$ $t_p = 0.05\text{ ms}; V_{DS} \leq 200\text{ V}; R_{GS} = 50\text{ }\Omega;$ $V_{GS} = 10\text{ V};$ starting at $T_j = 25\text{ °C}$	-	22	mJ

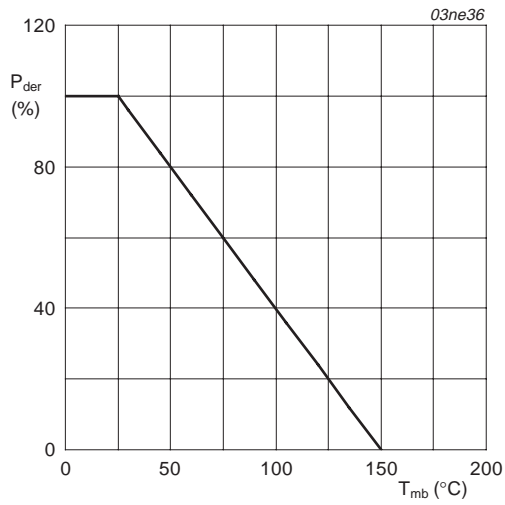

$$P_{der} = \frac{P_{tot}}{P_{tot(25^{\circ}C)}} \times 100\%$$

Fig 1. Normalized total power dissipation as a function of mounting base temperature

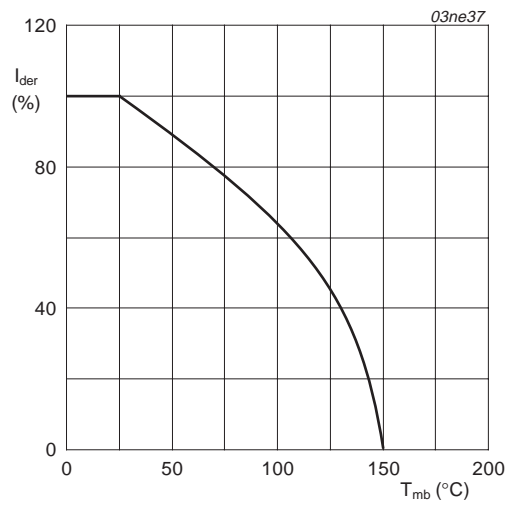

$$I_{der} = \frac{I_D}{I_{D(25^{\circ}C)}} \times 100\%$$

Fig 2. Normalized continuous drain current as a function of mounting base temperature

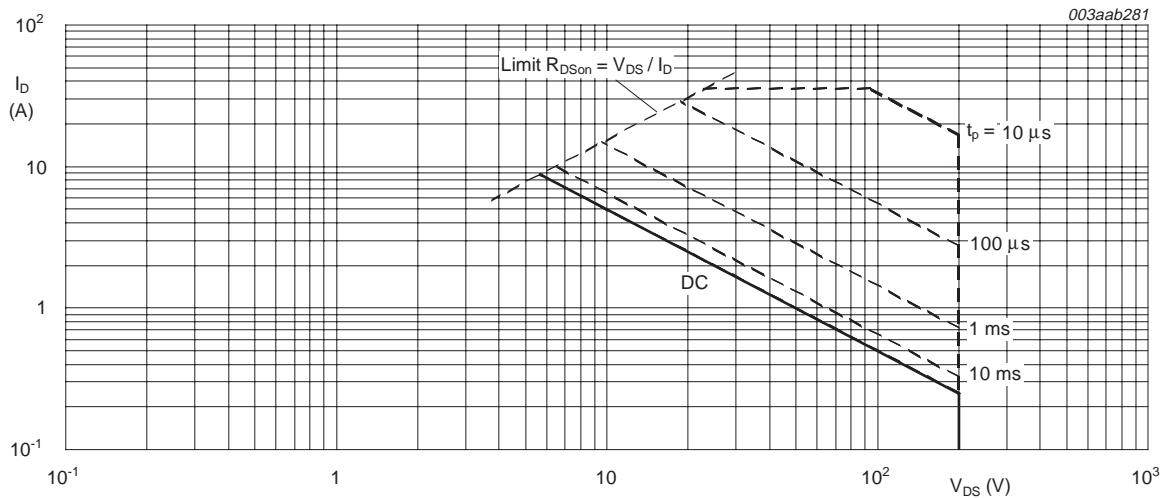

$T_{mb} = 25^{\circ}C$; I_{DM} is single pulse; $V_{GS} = 10\text{ V}$

Fig 3. Safe operating area; continuous and peak drain currents as a function of drain-source voltage

5. Thermal characteristics

Table 4. Thermal characteristics

Symbol	Parameter	Conditions	Min	Typ	Max	Unit
$R_{th(j-mb)}$	thermal resistance from junction to mounting base	see Figure 4	-	-	2.5	K/W
$R_{th(j-a)}$	thermal resistance from junction to ambient	minimum footprint	[1]	-	60	-

[1] Mounted on a printed-circuit board; vertical in still air.

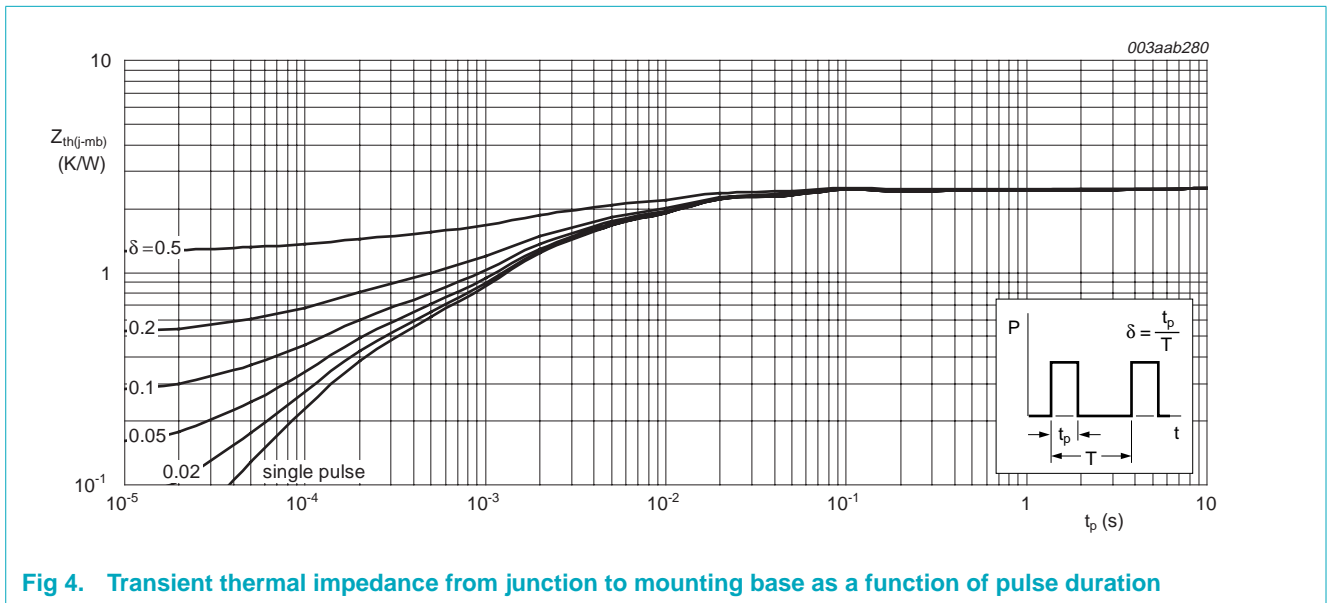
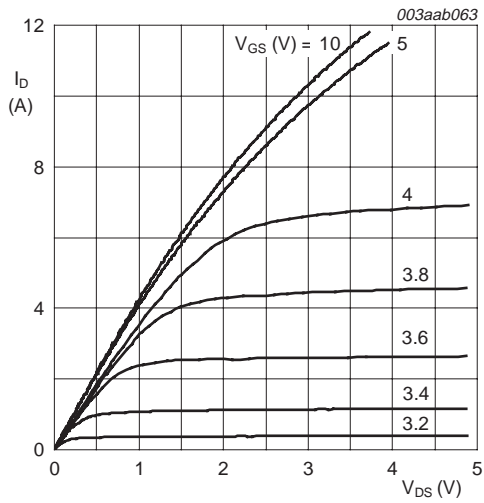

Fig 4. Transient thermal impedance from junction to mounting base as a function of pulse duration

6. Characteristics

Table 5. Characteristics
 $T_j = 25\text{ °C}$ unless otherwise specified.

Symbol	Parameter	Conditions	Min	Typ	Max	Unit
Static characteristics						
$V_{(BR)DSS}$	drain-source breakdown voltage	$I_D = 250\ \mu\text{A}$; $V_{GS} = 0\ \text{V}$ $T_j = 25\text{ °C}$	200	-	-	V
		$T_j = -55\text{ °C}$	178	-	-	V
$V_{GS(th)}$	gate-source threshold voltage	$I_D = 1\ \text{mA}$; $V_{DS} = V_{GS}$; see Figure 9 and 10 $T_j = 25\text{ °C}$	2	3	4	V
		$T_j = 150\text{ °C}$	1.2	-	-	V
		$T_j = -55\text{ °C}$	-	-	4.4	V
I_{DSS}	drain leakage current	$V_{DS} = 160\ \text{V}$; $V_{GS} = 0\ \text{V}$ $T_j = 25\text{ °C}$	-	-	1	μA
		$T_j = 150\text{ °C}$	-	-	100	μA
I_{GSS}	gate leakage current	$V_{GS} = \pm 20\ \text{V}$; $V_{DS} = 0\ \text{V}$	-	10	100	nA
R_G	gate resistance	$f = 1\ \text{MHz}$	-	0.6	-	Ω
$R_{DS(on)}$	drain-source on-state resistance	$V_{GS} = 10\ \text{V}$; $I_D = 2.6\ \text{A}$; see Figure 6 and 8 $T_j = 25\text{ °C}$	-	250	294	m Ω
		$T_j = 150\text{ °C}$	-	550	647	m Ω
		$V_{GS} = 6\ \text{V}$; $I_D = 2.5\ \text{A}$	-	263	309	m Ω
Dynamic characteristics						
$Q_{G(tot)}$	total gate charge	$I_D = 2.6\ \text{A}$; $V_{DS} = 100\ \text{V}$; $V_{GS} = 10\ \text{V}$; see Figure 11 and 12	-	13.3	-	nC
Q_{GS}	gate-source charge		-	2.4	-	nC
Q_{GS1}	pre- $V_{GS(th)}$ gate-source charge		-	1.15	-	nC
Q_{GS2}	post- $V_{GS(th)}$ gate-source charge		-	1.25	-	nC
Q_{GD}	gate-drain charge		-	4.2	-	nC
$V_{GS(pl)}$	gate-source plateau voltage		-	4.2	-	V
C_{iss}	input capacitance	$V_{GS} = 0\ \text{V}$; $V_{DS} = 30\ \text{V}$; $f = 1\ \text{MHz}$; see Figure 14	-	657	-	pF
C_{oss}	output capacitance		-	74	-	pF
C_{rss}	reverse transfer capacitance		-	25	-	pF
$t_{d(on)}$	turn-on delay time	$V_{DS} = 100\ \text{V}$; $R_L = 100\ \Omega$; $V_{GS} = 10\ \text{V}$; $R_G = 5.6\ \Omega$	-	7	-	ns
t_r	rise time		-	11	-	ns
$t_{d(off)}$	turn-off delay time		-	19	-	ns
t_f	fall time		-	7	-	ns
Source-drain diode						
V_{SD}	source-drain voltage	$I_S = 3.2\ \text{A}$; $V_{GS} = 0\ \text{V}$; see Figure 13	-	0.8	1.2	V
t_{rr}	reverse recovery time	$I_S = 3.2\ \text{A}$; $dI_S/dt = -100\ \text{A}/\mu\text{s}$; $V_{GS} = 0\ \text{V}$;	-	101	-	ns
Q_r	recovered charge	$V_R = 120\ \text{V}$	-	267	-	nC



$T_j = 25^\circ\text{C}$

Fig 5. Output characteristics: drain current as a function of drain-source voltage; typical values

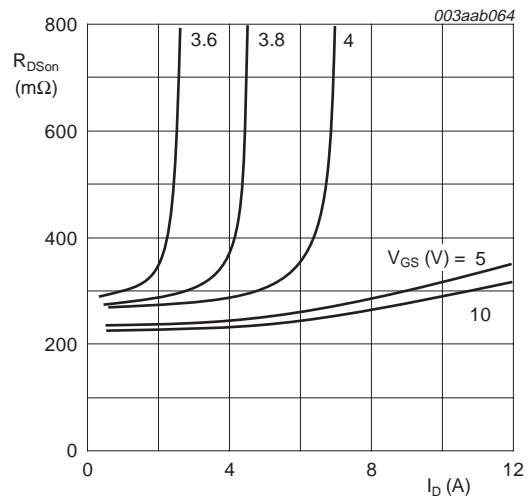

$T_j = 25^\circ\text{C}$

Fig 6. Drain-source on-state resistance as a function of drain current; typical values

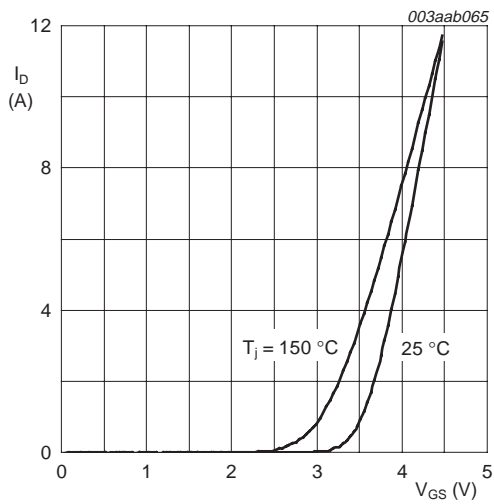

$T_j = 25^\circ\text{C}$ and 150°C ; $V_{DS} > I_D \times R_{DS(on)}$

Fig 7. Transfer characteristics: drain current as a function of gate-source voltage; typical values

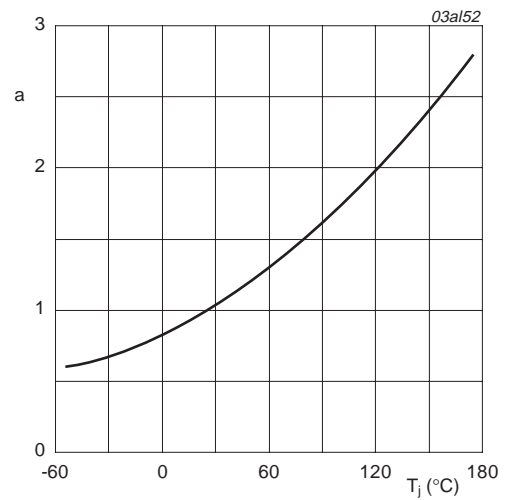

$$a = \frac{R_{DS(on)}}{R_{DS(on)(25^\circ\text{C})}}$$

Fig 8. Normalized drain-source on-state resistance factor as a function of junction temperature

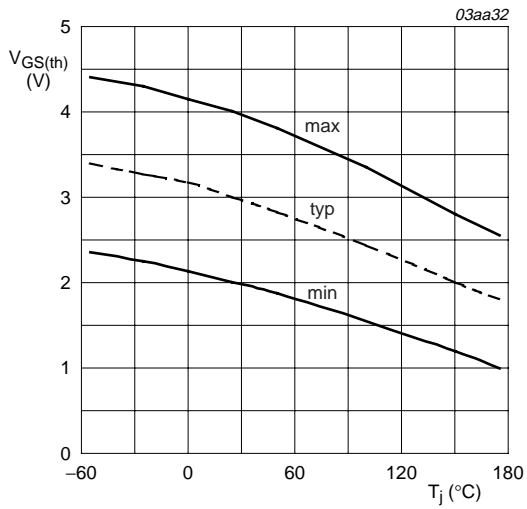

$I_D = 1 \text{ mA}; V_{DS} = V_{GS}$

Fig 9. Gate-source threshold voltage as a function of junction temperature

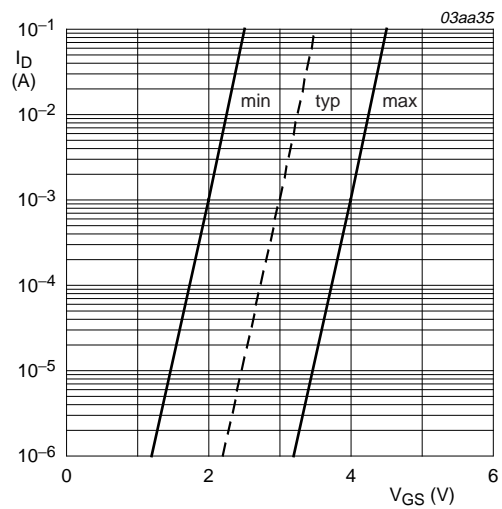

$T_j = 25 \text{ }^\circ\text{C}; V_{DS} = 5 \text{ V}$

Fig 10. Sub-threshold drain current as a function of gate-source voltage

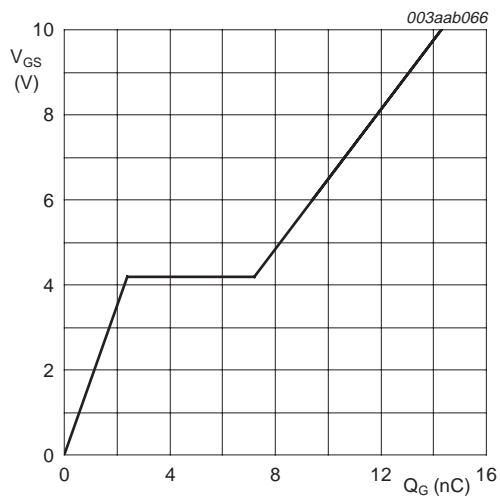

$I_D = 2.6 \text{ A}; V_{DS} = 100 \text{ V}$

Fig 11. Gate-source voltage as a function of gate charge; typical values

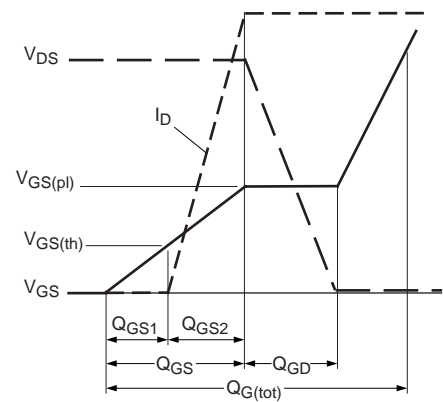
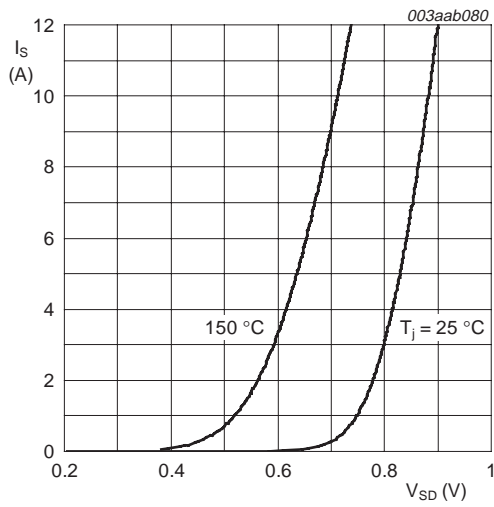
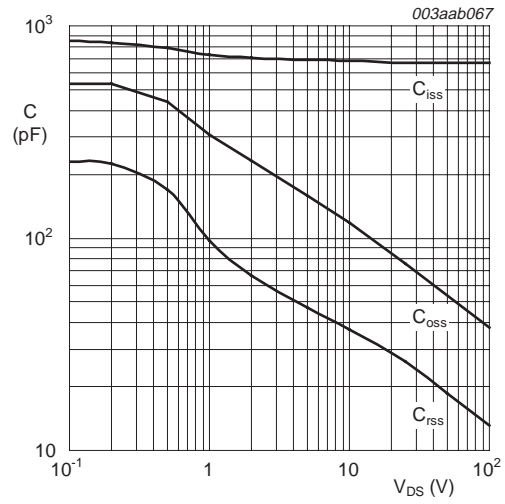

Fig 12. Gate charge waveform definitions



$T_j = 25\text{ }^\circ\text{C}$ and $150\text{ }^\circ\text{C}$; $V_{GS} = 0\text{ V}$

Fig 13. Source current as a function of source-drain voltage; typical values



$V_{GS} = 0\text{ V}$; $f = 1\text{ MHz}$

Fig 14. Input, output and reverse transfer capacitances as a function of drain-source voltage; typical values

7. Package outline

HVSON8: plastic thermal enhanced very thin small outline package; no leads;
8 terminals; body 3.3 × 3.3 × 0.85 mm

SOT873-1

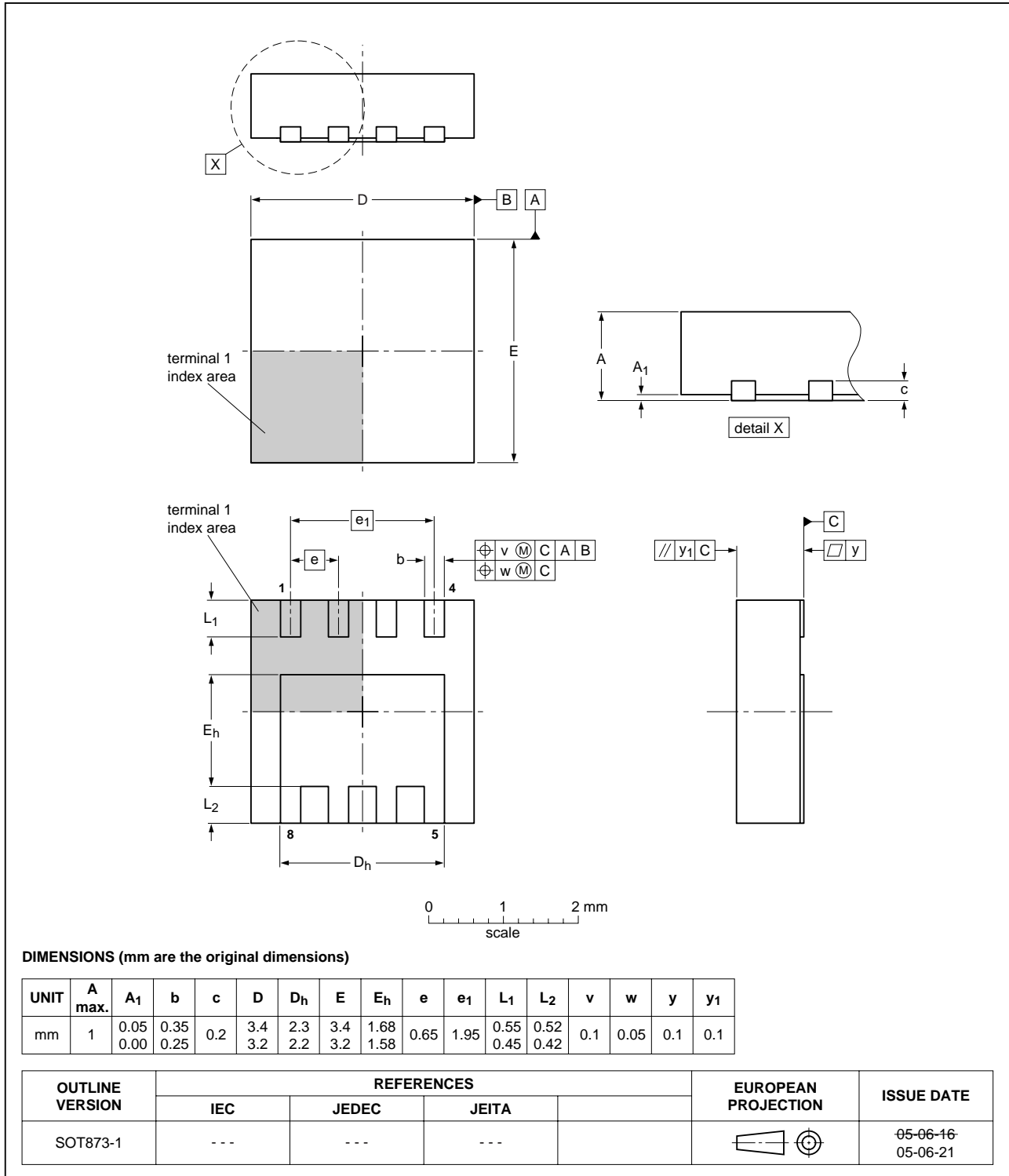

Fig 15. Package outline SOT873-1 (HVSON8)

8. Revision history

Table 6. Revision history

Document ID	Release date	Data sheet status	Change notice	Supersedes
PML260SN_2	20060529	Product data sheet	-	PML260SN_1
Modifications:	<ul style="list-style-type: none">The format of this data sheet has been redesigned to comply with the new presentation and information standard of Philips Semiconductors.			
PML260SN_1	20051222	Preliminary data sheet	-	-

9. Legal information

9.1 Data sheet status

Document status ^{[1][2]}	Product status ^[3]	Definition
Objective [short] data sheet	Development	This document contains data from the objective specification for product development.
Preliminary [short] data sheet	Qualification	This document contains data from the preliminary specification.
Product [short] data sheet	Production	This document contains the product specification.

[1] Please consult the most recently issued document before initiating or completing a design.

[2] The term 'short data sheet' is explained in section "Definitions".

[3] The product status of device(s) described in this document may have changed since this document was published and may differ in case of multiple devices. The latest product status information is available on the Internet at URL <http://www.semiconductors.philips.com>.

9.2 Definitions

Draft — The document is a draft version only. The content is still under internal review and subject to formal approval, which may result in modifications or additions. Philips Semiconductors does not give any representations or warranties as to the accuracy or completeness of information included herein and shall have no liability for the consequences of use of such information.

Short data sheet — A short data sheet is an extract from a full data sheet with the same product type number(s) and title. A short data sheet is intended for quick reference only and should not be relied upon to contain detailed and full information. For detailed and full information see the relevant full data sheet, which is available on request via the local Philips Semiconductors sales office. In case of any inconsistency or conflict with the short data sheet, the full data sheet shall prevail.

9.3 Disclaimers

General — Information in this document is believed to be accurate and reliable. However, Philips Semiconductors does not give any representations or warranties, expressed or implied, as to the accuracy or completeness of such information and shall have no liability for the consequences of use of such information.

Right to make changes — Philips Semiconductors reserves the right to make changes to information published in this document, including without limitation specifications and product descriptions, at any time and without notice. This document supersedes and replaces all information supplied prior to the publication hereof.

Suitability for use — Philips Semiconductors products are not designed, authorized or warranted to be suitable for use in medical, military, aircraft, space or life support equipment, nor in applications where failure or malfunction of a Philips Semiconductors product can reasonably be expected

to result in personal injury, death or severe property or environmental damage. Philips Semiconductors accepts no liability for inclusion and/or use of Philips Semiconductors products in such equipment or applications and therefore such inclusion and/or use is for the customer's own risk.

Applications — Applications that are described herein for any of these products are for illustrative purposes only. Philips Semiconductors makes no representation or warranty that such applications will be suitable for the specified use without further testing or modification.

Limiting values — Stress above one or more limiting values (as defined in the Absolute Maximum Ratings System of IEC 60134) may cause permanent damage to the device. Limiting values are stress ratings only and operation of the device at these or any other conditions above those given in the Characteristics sections of this document is not implied. Exposure to limiting values for extended periods may affect device reliability.

Terms and conditions of sale — Philips Semiconductors products are sold subject to the general terms and conditions of commercial sale, as published at <http://www.semiconductors.philips.com/profile/terms>, including those pertaining to warranty, intellectual property rights infringement and limitation of liability, unless explicitly otherwise agreed to in writing by Philips Semiconductors. In case of any inconsistency or conflict between information in this document and such terms and conditions, the latter will prevail.

No offer to sell or license — Nothing in this document may be interpreted or construed as an offer to sell products that is open for acceptance or the grant, conveyance or implication of any license under any copyrights, patents or other industrial or intellectual property rights.

9.4 Trademarks

Notice: All referenced brands, product names, service names and trademarks are the property of their respective owners.

TrenchMOS — is a trademark of Koninklijke Philips Electronics N.V.

10. Contact information

For additional information, please visit: <http://www.semiconductors.philips.com>

For sales office addresses, send an email to: sales.addresses@www.semiconductors.philips.com

11. Contents

1	Product profile	1
1.1	General description	1
1.2	Features	1
1.3	Applications	1
1.4	Quick reference data	1
2	Pinning information	1
3	Ordering information	2
4	Limiting values	2
5	Thermal characteristics	4
6	Characteristics	5
7	Package outline	9
8	Revision history	10
9	Legal information	11
9.1	Data sheet status	11
9.2	Definitions	11
9.3	Disclaimers	11
9.4	Trademarks	11
10	Contact information	11
11	Contents	12



Please be aware that important notices concerning this document and the product(s) described herein, have been included in section 'Legal information'.

© Koninklijke Philips Electronics N.V. 2006. All rights reserved.

For more information, please visit: <http://www.semiconductors.philips.com>.

For sales office addresses, email to: sales.addresses@www.semiconductors.philips.com.

Date of release: 29 May 2006

Document identifier: PML260SN_2