

FEATURES

- Operate with 3.3 V supply
- Interoperable with 5 V logic
- EIA RS-422 and RS-485 compliant over full common-mode range
- Data rate options
 - ADM3483/ADM3488: 250 kbps
 - ADM3485/ADM3490/ADM3491: 10 Mbps
- Half- and full-duplex options
- Reduced slew rates for low EMI (ADM3483 and ADM3488)
- 2 nA supply current in shutdown mode (ADM3483/ADM3485/ADM3491)
- Up to 32 transceivers on the bus
- 7 V to +12 V bus common-mode range
- Specified over the -40°C to +85°C temperature range
- 8 ns skew (ADM3485/ADM3490/ADM3491)
- 8-lead SOIC and 14-lead SOIC (ADM3491 only) packages

APPLICATIONS

- Low power RS-485/RS-422 applications
- Telecom
- Industrial process control
- HVAC

GENERAL DESCRIPTION

The ADM3483/ADM3485/ADM3488/ADM3490/ADM3491 are low power, differential line transceivers designed to operate using a single 3.3 V power supply. Low power consumption, coupled with a shutdown mode, makes the ADM3483/ADM3485/ADM3488/ADM3490/ADM3491 ideal for power-sensitive applications.

The ADM3488/ADM3490/ADM3491 feature full-duplex communication, while the ADM3483/ADM3485 are designed for half-duplex communication.

The ADM3483/ADM3488 feature slew rate limited drivers that minimize EMI and reduce reflections caused by improperly terminated cables, allowing error-free data transmission at data rates up to 250 kbps.

The ADM3485/ADM3490/ADM3491 transmit at up to 10 Mbps. The receiver input impedance is 12 k Ω , allowing up to 32 transceivers to be connected on the bus. A thermal shutdown circuit prevents excessive power dissipation caused by bus contention or by output shorting. If a significant temperature increase is detected

FUNCTIONAL BLOCK DIAGRAMS

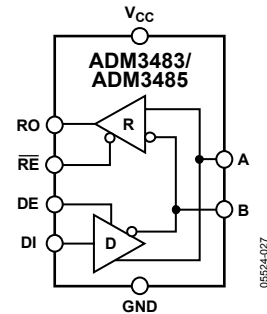

Figure 1.

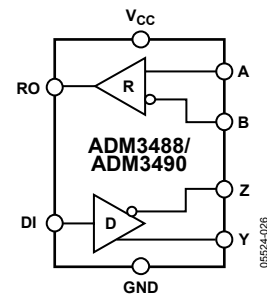

Figure 2.

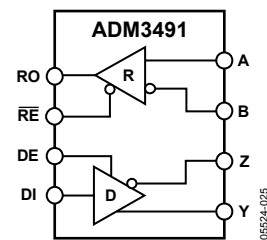

Figure 3.

in the internal driver circuitry during fault conditions, then the thermal shutdown circuit forces the driver output into a high impedance state. If the inputs are unconnected (floating), the receiver contains a fail-safe feature that results in a logic high output state. The parts are fully specified over the commercial and industrial temperature ranges. The ADM3483/ADM3485/ADM3488/ADM3490 are available in 8-lead SOIC_N; the ADM3491 is available in a 14-lead SOIC_N.

Rev. B

Information furnished by Analog Devices is believed to be accurate and reliable. However, no responsibility is assumed by Analog Devices for its use, nor for any infringements of patents or other rights of third parties that may result from its use. Specifications subject to change without notice. No license is granted by implication or otherwise under any patent or patent rights of Analog Devices. Trademarks and registered trademarks are the property of their respective owners.

TABLE OF CONTENTS

Features	1	Typical Performance Characteristics	12
Applications.....	1	Circuit Description.....	14
General Description	1	Devices with Receiver/Driver Enables—	
Functional Block Diagrams.....	1	ADM3483/ADM3485/ADM3491	14
Revision History	2	Devices Without Receiver/Driver Enables—	
Specifications.....	4	ADM3488/ADM3490	14
Timing Specifications—ADM3485/ADM3490/ADM3491.....	5	Reduced EMI and Reflections—ADM3483/ADM3488	14
Timing Specifications—ADM3483/ADM3488.....	5	Low Power Shutdown Mode	14
Timing Specifications—ADM3483/ADM3485/ADM3488/ ADM3490/ADM3491	6	Driver Output Protection.....	14
Absolute Maximum Ratings.....	7	Propagation Delay	14
ESD Caution.....	7	Typical Applications.....	14
Pin Configurations and Function Descriptions	8	Line Length vs. Data Rate	15
Test Circuits.....	9	Outline Dimensions	17
Switching Characteristics	11	Ordering Guide	18

REVISION HISTORY

10/06—Rev. A to Rev. B

Updated Format.....	Universal
Added ADM3491.....	Universal
Changes to Specifications Section	4
Changes to Typical Applications Section	14

7/06—Rev. 0 to Rev. A

Changes to Applications	1
Changes to General Description	1
Changes to Figure 19.....	10
Changes to Typical Applications Section	13
Changes to Figure 31 and Figure 32.....	14
Updated Outline Dimensions	15

10/05—Revision 0: Initial Version

ADM3483/ADM3485/ADM3488/ADM3490/ADM3491

Table 1. ADM34xx Part Comparison

Part No.	Guaranteed Data Rate (Mbps)	Supply Voltage (V)	Half-/Full-Duplex	Slew Rate Limited	Driver/Receiver Enable	Shutdown Current (nA)	Pin Count
ADM3483	0.25	3.0 to 3.6	Half	Yes	Yes	2	8
ADM3485	10	3.0 to 3.6	Half	No	Yes	2	8
ADM3488	0.25	3.0 to 3.6	Full	Yes	No	N/A	8
ADM3490	10	3.0 to 3.6	Full	No	No	N/A	8
ADM3491	10	3.0 to 3.6	Full	No	Yes	2	14

ADM3483/ADM3485/ADM3488/ADM3490/ADM3491

SPECIFICATIONS

$V_{CC} = 3.3 \text{ V} \pm 0.3 \text{ V}$, $T_A = T_{MIN}$ to T_{MAX} , unless otherwise noted.

Table 2.

Parameter	Min	Typ	Max	Unit	Test Conditions/Comments
DRIVER					
Differential Output Voltage (V_{OD})	2.0			V	$R_L = 100 \Omega$ (RS-422), $V_{CC} = 3.3 \text{ V} \pm 5\%$ (see Figure 7)
	1.5			V	$R_L = 54 \Omega$ (RS-485) (see Figure 7)
	1.5			V	$R_L = 60 \Omega$ (RS-485), $V_{CC} = 3.3 \text{ V}$ (see Figure 8)
$\Delta V_{OD} $ for Complementary Output States ¹			0.2	V	$R_L = 54 \Omega$ or 100Ω (see Figure 7)
Common-Mode Output Voltage (V_{OC})			3	V	$R_L = 54 \Omega$ or 100Ω (see Figure 7)
$\Delta V_{OC} $ for Common-Mode Output Voltage ¹			0.2	V	$R_L = 54 \Omega$ or 100Ω (see Figure 7)
DRIVER INPUT LOGIC					
CMOS Input Logic Threshold Low (V_{IH})			0.8	V	DE, DI, \overline{RE}
CMOS Input Logic Threshold High (V_{IL})	2.0			V	DE, DI, \overline{RE}
CMOS Logic Input Current (I_{IN1})			± 2	μA	DE, DI, \overline{RE}
Input Current—A, B (I_{IN2})			1.0	mA	$V_{IN} = 12 \text{ V}$, DE = 0 V, $V_{CC} = 0 \text{ V}$ or 3.6 V
			-0.8	mA	$V_{IN} = -7 \text{ V}$, DE = 0 V, $V_{CC} = 0 \text{ V}$ or 3.6 V
Output Leakage—Y, Z (I_o)		0.1		μA	$V_{IN} = 12 \text{ V}$, DE = 0 V, $\overline{RE} = 0 \text{ V}$, $V_{CC} = 0 \text{ V}$ or 3.6 V, ADM3491 only
		-0.1		μA	$V_{IN} = -7 \text{ V}$, DE = 0 V, $\overline{RE} = 0 \text{ V}$, $V_{CC} = 0 \text{ V}$ or 3.6 V, ADM3491 only
Output Leakage (Y, Z) in Shutdown Mode (I_o)		0.01		μA	$V_{IN} = 12 \text{ V}$, DE = 0 V, $\overline{RE} = V_{CC}$, $V_{CC} = 0 \text{ V}$ or 3.6 V, ADM3491 only
		-0.01		μA	$V_{IN} = -7 \text{ V}$, DE = 0 V, $\overline{RE} = V_{CC}$, $V_{CC} = 0 \text{ V}$ or 3.6 V, ADM3491 only
RECEIVER					
Differential Input Threshold Voltage (V_{TH})	-0.2		+0.2	V	$-7 \text{ V} < V_{CM} < +12 \text{ V}$
Input Hysteresis (ΔV_{TH})		50		mV	$V_{CM} = 0 \text{ V}$
CMOS Output Voltage High (V_{OH})	$V_{CC} - 0.4$			V	$I_{OUT} = -1.5 \text{ mA}$, $V_{ID} = 200 \text{ mV}$ (see Figure 9)
CMOS Output Voltage Low (V_{OL})			0.4	V	$I_{OUT} = 2.5 \text{ mA}$, $V_{ID} = 200 \text{ mV}$ (see Figure 9)
Three-State Output Leakage Current (I_{OZR})			± 1	μA	$V_{CC} = 3.6 \text{ V}$, $0 \text{ V} \leq V_{OUT} \leq V_{CC}$
Input Resistance (R_{IN})	12			k Ω	$-7 \text{ V} < V_{CM} < +12 \text{ V}$
POWER SUPPLY CURRENT					
Supply Current (I_{CC})		1.1	2.2	mA	DE = V_{CC} , $\overline{RE} = 0 \text{ V}$ or V_{CC} , no load, DI = 0 V or V_{CC}
		0.95	1.9	mA	DE = 0 V, $\overline{RE} = 0 \text{ V}$, no load, DI = 0 V or V_{CC}
Supply Current in Shutdown Mode (I_{SHDN})		0.002	1	μA	DE = 0 V, $\overline{RE} = V_{CC}$, DI = V_{CC} or 0 V
Driver Short-Circuit Output Current (I_{OSD})			-250	mA	$V_{OUT} = -7 \text{ V}$
			250	mA	$V_{OUT} = 12 \text{ V}$
Receiver Short-Circuit Output Current (I_{OSR})	± 8		± 60	mA	$0 \text{ V} < V_{RO} < V_{CC}$

¹ ΔV_{OD} and ΔV_{OC} are the changes in V_{OD} and V_{OC} , respectively, when DI input changes state.

ADM3483/ADM3485/ADM3488/ADM3490/ADM3491

TIMING SPECIFICATIONS—ADM3485/ADM3490/ADM3491

$V_{CC} = 3.3\text{ V}$, $T_A = 25^\circ\text{C}$, unless otherwise noted.

Table 3.

Parameter	Min	Typ	Max	Unit	Test Conditions/Comments
DRIVER					
Differential Output Delay (t_{DD})	1	22	35	ns	$R_L = 60\ \Omega$ (see Figure 10 and Figure 16)
Differential Output Transition Time (t_{TD})	3	8	25	ns	$R_L = 60\ \Omega$ (see Figure 10 and Figure 16)
Propagation Delay, Low-to-High Level (t_{PLH})	7	22	35	ns	$R_L = 27\ \Omega$ (see Figure 11 and Figure 17)
Propagation Delay, High-to-Low Level (t_{PHL})	7	22	35	ns	$R_L = 27\ \Omega$ (see Figure 11 and Figure 17)
$ t_{PLH} - t_{PHL} $ Propagation Delay Skew ¹ (t_{PDS})			8	ns	$R_L = 27\ \Omega$ (see Figure 11 and Figure 17)
DRIVER OUTPUT ENABLE/DISABLE TIMES (ADM3485/ADM3491 ONLY)					
Output Enable Time to Low Level (t_{PZL})		45	90	ns	$R_L = 110\ \Omega$ (see Figure 13 and Figure 19)
Output Enable Time to High Level (t_{PZH})		45	90	ns	$R_L = 110\ \Omega$ (see Figure 12 and Figure 18)
Output Disable Time from High Level (t_{PHZ})		40	80	ns	$R_L = 110\ \Omega$ (see Figure 12 and Figure 18)
Output Disable Time from Low Level (t_{PLZ})		40	80	ns	$R_L = 110\ \Omega$ (see Figure 13 and Figure 19)
Output Enable Time from Shutdown to Low Level (t_{PSL})		650	900	ns	$R_L = 110\ \Omega$ (see Figure 13 and Figure 19)
Output Enable Time from Shutdown to High Level (t_{PSH})		650	900	ns	$R_L = 110\ \Omega$ (see Figure 12 and Figure 18)

¹ Measured on $|t_{PLH}(Y) - t_{PHL}(Y)|$ and $|t_{PLH}(Z) - t_{PHL}(Z)|$.

TIMING SPECIFICATIONS—ADM3483/ADM3488

$V_{CC} = 3.3\text{ V}$, $T_A = 25^\circ\text{C}$, unless otherwise noted.

Table 4.

Parameter	Min	Typ	Max	Unit	Test Conditions/Comments
DRIVER					
Differential Output Delay (t_{DD})	600	900	1400	ns	$R_L = 60\ \Omega$ (see Figure 10 and Figure 16)
Differential Output Transition Time (t_{TD})	400	700	1200	ns	$R_L = 60\ \Omega$ (see Figure 10 and Figure 16)
Propagation Delay, Low-to-High Level (t_{PLH})	700	1000	1500	ns	$R_L = 27\ \Omega$ (see Figure 11 and Figure 17)
Propagation Delay, High-to-Low Level (t_{PHL})	700	1000	1500	ns	$R_L = 27\ \Omega$ (see Figure 11 and Figure 17)
$ t_{PLH} - t_{PHL} $ Propagation Delay Skew ¹ (t_{PDS})		100		ns	$R_L = 27\ \Omega$ (see Figure 11 and Figure 17)
DRIVER OUTPUT ENABLE/DISABLE TIMES (ADM3483 ONLY)					
Output Enable Time to Low Level (t_{PZL})		900	1300	ns	$R_L = 110\ \Omega$ (see Figure 13 and Figure 19)
Output Enable Time to High Level (t_{PZH})		600	800	ns	$R_L = 110\ \Omega$ (see Figure 12 and Figure 18)
Output Disable Time from High Level (t_{PHZ})		50	80	ns	$R_L = 110\ \Omega$ (see Figure 12 and Figure 18)
Output Disable Time from Low Level (t_{PLZ})		50	80	ns	$R_L = 110\ \Omega$ (see Figure 13 and Figure 19)
Output Enable Time from Shutdown to Low Level (t_{PSL})		1.9	2.7	μs	$R_L = 110\ \Omega$ (see Figure 13 and Figure 19)
Output Enable Time from Shutdown to High Level (t_{PSH})		2.2	3.0	μs	$R_L = 110\ \Omega$ (see Figure 12 and Figure 18)

¹ Measured on $|t_{PLH}(Y) - t_{PHL}(Y)|$ and $|t_{PLH}(Z) - t_{PHL}(Z)|$.

ADM3483/ADM3485/ADM3488/ADM3490/ADM3491

TIMING SPECIFICATIONS—ADM3483/ADM3485/ADM3488/ADM3490/ADM3491

$V_{CC} = 3.3\text{ V}$, $T_A = 25^\circ\text{C}$, unless otherwise noted.

Table 5.

Parameter	Min	Typ	Max	Unit	Test Conditions/Comments
RECEIVER					
Time to Shutdown (t_{SHDN})					
ADM3483/ADM3485/ADM3491 ¹	80	190	300	ns	
Propagation Delay, Low-to-High Level (t_{RPLH})					
ADM3485/ADM3490/ADM3491	25	65	90	ns	$V_{ID} = 0\text{ V to }3.0\text{ V}$, $C_L = 15\text{ pF}$ (see Figure 14 and Figure 20)
ADM3483/ADM3488	25	75	120	ns	
Propagation Delay, High-to-Low Level (t_{RPHL})					
ADM3485/ADM3490/ADM3491	25	65	90	ns	$V_{ID} = 0\text{ V to }3.0\text{ V}$, $C_L = 15\text{ pF}$ (see Figure 14 and Figure 20)
ADM3483/ADM3488	25	75	120	ns	
$ t_{PLH} - t_{PHL} $ Propagation Delay Skew (t_{RPDS})					
ADM3485/ADM3490/ADM3491			10	ns	$V_{ID} = 0\text{ V to }3.0\text{ V}$, $C_L = 15\text{ pF}$ (see Figure 14 and Figure 20)
ADM3483/ADM3488			20	ns	
RECEIVER OUTPUT ENABLE/DISABLE TIMES (ADM3483/ADM3485/ADM3491 ONLY)					
Output Enable Time to Low Level (t_{PRZL})		25	50	ns	$C_L = 15\text{ pF}$ (see Figure 15 and Figure 21)
Output Enable Time to High Level (t_{PRZH})		25	50	ns	$C_L = 15\text{ pF}$ (see Figure 15 and Figure 21)
Output Disable Time from High Level (t_{PRHZ})		25	45	ns	$C_L = 15\text{ pF}$ (see Figure 15 and Figure 21)
Output Disable Time from Low Level (t_{PRLZ})		25	45	ns	$C_L = 15\text{ pF}$ (see Figure 15 and Figure 21)
Output Enable Time from Shutdown to Low Level (t_{PRSL})		720	1400	ns	$C_L = 15\text{ pF}$ (see Figure 15 and Figure 21)
Output Enable Time from Shutdown to High Level (t_{PRSH})		720	1400	ns	$C_L = 15\text{ pF}$ (see Figure 15 and Figure 21)

¹ The transceivers are put into shutdown by bringing the \overline{RE} high and DE low. If the inputs are in this state for less than 80 ns, the parts are guaranteed not to enter shutdown. If the parts are in this state for 300 ns or more, the parts are guaranteed to enter shutdown.

ABSOLUTE MAXIMUM RATINGS

$T_A = 25^\circ\text{C}$, unless otherwise noted.

Table 6.

Parameter	Rating
V_{CC} to GND	7 V
Digital I/O Voltage (DE, $\overline{\text{RE}}$, DI)	$-0.3\text{ V to }V_{CC} + 0.3\text{ V}$
Digital I/O Voltage (RO)	$V_{CC} - 0.5\text{ V to }V_{CC} + 0.5\text{ V}$
Driver Output/Receiver Input Voltage	$-7.5\text{ V to }+12.5\text{ V}$
Operating Temperature Range	$-40^\circ\text{C to }+85^\circ\text{C}$
Storage Temperature Range	$-65^\circ\text{C to }+125^\circ\text{C}$
θ_{JA} Thermal Impedance	
8-Lead SOIC	121°C/W
14-Lead SOIC	86°C/W
Lead Temperature	
Soldering (10 sec)	300°C
Vapor Phase (60 sec)	215°C
Infrared (15 sec)	220°C

Stresses above those listed under Absolute Maximum Ratings may cause permanent damage to the device. This is a stress rating only; functional operation of the device at these or any other conditions above those indicated in the operational section of this specification is not implied. Exposure to absolute maximum rating conditions for extended periods may affect device reliability.

ESD CAUTION



ESD (electrostatic discharge) sensitive device. Charged devices and circuit boards can discharge without detection. Although this product features patented or proprietary protection circuitry, damage may occur on devices subjected to high energy ESD. Therefore, proper ESD precautions should be taken to avoid performance degradation or loss of functionality.

ADM3483/ADM3485/ADM3488/ADM3490/ADM3491

PIN CONFIGURATIONS AND FUNCTION DESCRIPTIONS

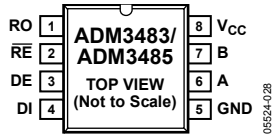

Figure 4. ADM3483/ADM3485 Pin Configuration

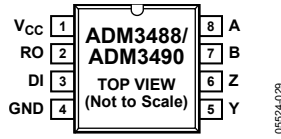

Figure 5. ADM3488/ADM3490 Pin Configuration

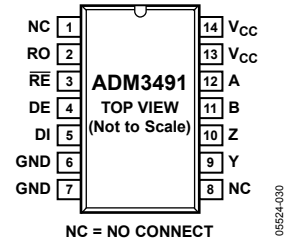

Figure 6. ADM3491 Pin Configuration

Table 7. Pin Function Descriptions

ADM3483/ADM3485 Pin No.	ADM3488/ADM3490 Pin No.	ADM3491 Pin No.	Mnemonic	Description
1	2	2	RO	Receiver Output. When enabled, if $A > B$ by 200 mV, then $RO = \text{high}$. If $A < B$ by 200 mV, then $RO = \text{low}$.
2	N/A	3	\overline{RE}	Receiver Output Enable. A low level enables the receiver output, RO. A high level places it in a high impedance state. If \overline{RE} is high and DE is low, the device enters a low power shutdown mode.
3	N/A	4	DE	Driver Output Enable. A high level enables the driver differential Output A and Output B. A low level places it in a high impedance state. If \overline{RE} is high and DE is low, the device enters a low power shutdown mode.
4	3	5	DI	Driver Input. With a half-duplex part when the driver is enabled, a logic low on DI forces A low and B high while a logic high on DI forces A high and B low. With a full-duplex part when the driver is enabled, a logic low on DI forces Y low and Z high while a logic high on DI forces Y high and Z low.
5	4	6, 7	GND	Ground.
N/A	5	9	Y	Noninverting Driver Output.
N/A	6	10	Z	Inverting Driver Output.
6	N/A	N/A	A	Noninverting Receiver Input A and Noninverting Driver Output A.
N/A	8	12	A	Noninverting Receiver Input A.
7	N/A	N/A	B	Inverting Receiver Input B and Inverted Driver Output B.
N/A	7	11	B	Inverting Receiver Input B.
8	1	13, 14	V_{CC}	Power Supply ($3.3 \text{ V} \pm 0.3 \text{ V}$).
N/A	N/A	1, 8	NC	No Connect.

TEST CIRCUITS

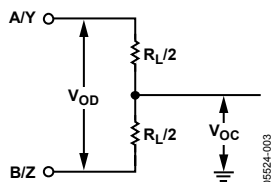

Figure 7. Differential Output Voltage and Common-Mode Voltage Drivers

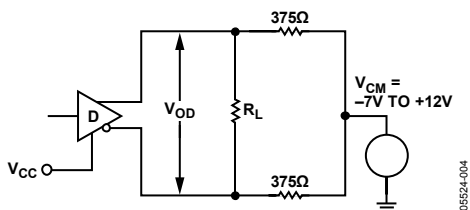

Figure 8. Differential Output Voltage Drivers with Varying Common-Mode Voltage

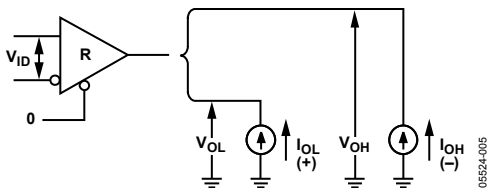
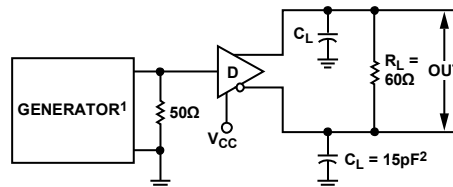
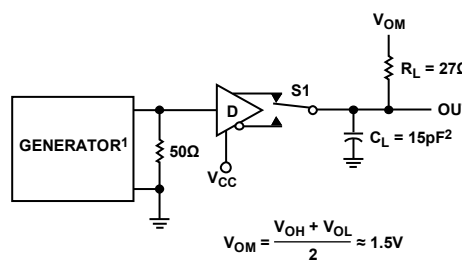

Figure 9. CMOS Output Voltage High and CMOS Output Voltage Low Receivers



¹PPR = 250kHz, 50% DUTY CYCLE, $t_R \leq 6.0\text{ns}$, $Z_O = 50\Omega$.
² C_L INCLUDES PROBE AND STRAY CAPACITANCE.

Figure 10. Driver Differential Output Delay and Transition Times



¹PPR = 250kHz, 50% DUTY CYCLE, $t_R \leq 6.0\text{ns}$, $Z_O = 50\Omega$.
² C_L INCLUDES PROBE AND STRAY CAPACITANCE.

Figure 11. Driver Propagation Delays

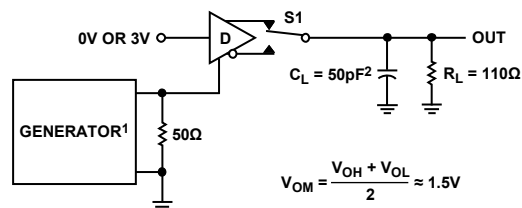

¹PPR = 250kHz, 50% DUTY CYCLE, $t_R \leq 6.0\text{ns}$, $Z_O = 50\Omega$.
² C_L INCLUDES PROBE AND STRAY CAPACITANCE.

Figure 12. Driver Enable and Disable Times (t_{PZH} , t_{PSH} , t_{PHZ})

ADM3483/ADM3485/ADM3488/ADM3490/ADM3491

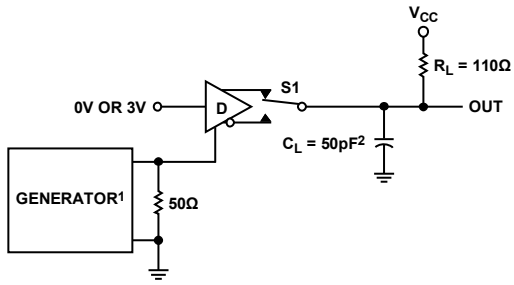

¹PPR = 250kHz, 50% DUTY CYCLE, $t_R \leq 6.0\text{ns}$, $Z_O = 50\Omega$.
² C_L INCLUDES PROBE AND STRAY CAPACITANCE.

05524-039

Figure 13. Driver Enable and Disable Times (t_{pZL} , t_{pSL} , t_{pLZ})

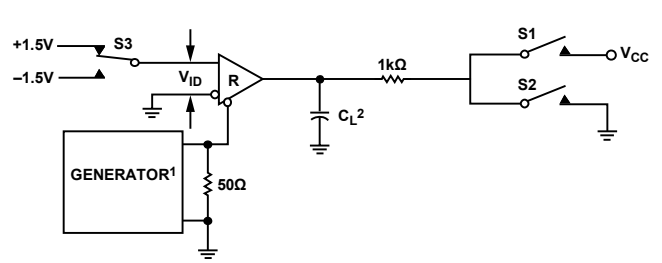

¹PPR = 250kHz, 50% DUTY CYCLE, $t_R \leq 6.0\text{ns}$, $Z_O = 50\Omega$.
² C_L INCLUDES PROBE AND STRAY CAPACITANCE.

05524-041

Figure 15. Receiver Enable and Disable Times

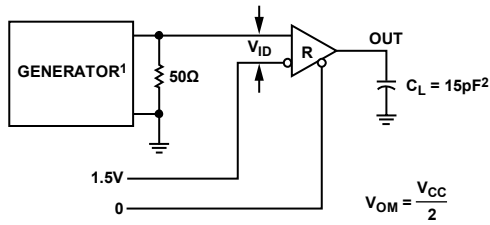

¹PPR = 250kHz, 50% DUTY CYCLE, $t_R \leq 6.0\text{ns}$, $Z_O = 50\Omega$.
² C_L INCLUDES PROBE AND STRAY CAPACITANCE.

05524-040

Figure 14. Receiver Propagation Delays

SWITCHING CHARACTERISTICS

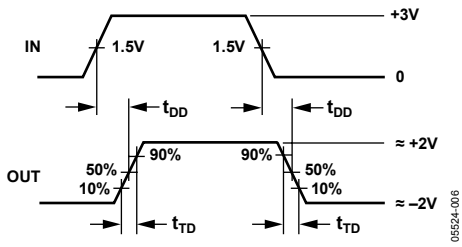

Figure 16. Driver Differential Output Delay and Transition Times

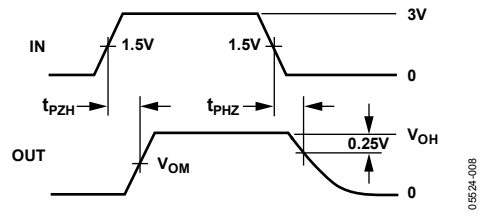

Figure 18. Driver Enable and Disable Times (t_{PZH} , t_{PSH} , t_{PHZ})

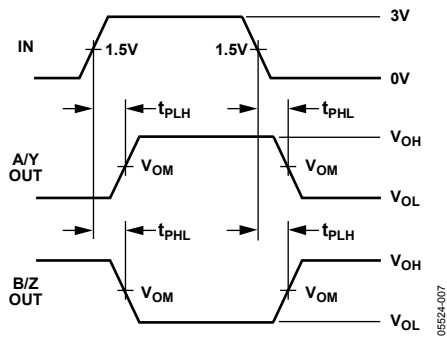

Figure 17. Driver Propagation Delays

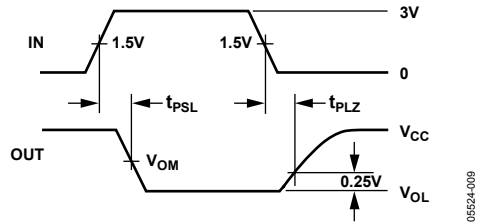

Figure 19. Driver Enable and Disable Times (t_{PZL} , t_{PSL} , t_{PLZ})

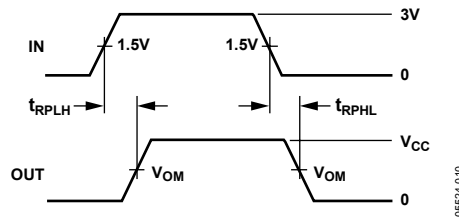

Figure 20. Receiver Propagation Delays

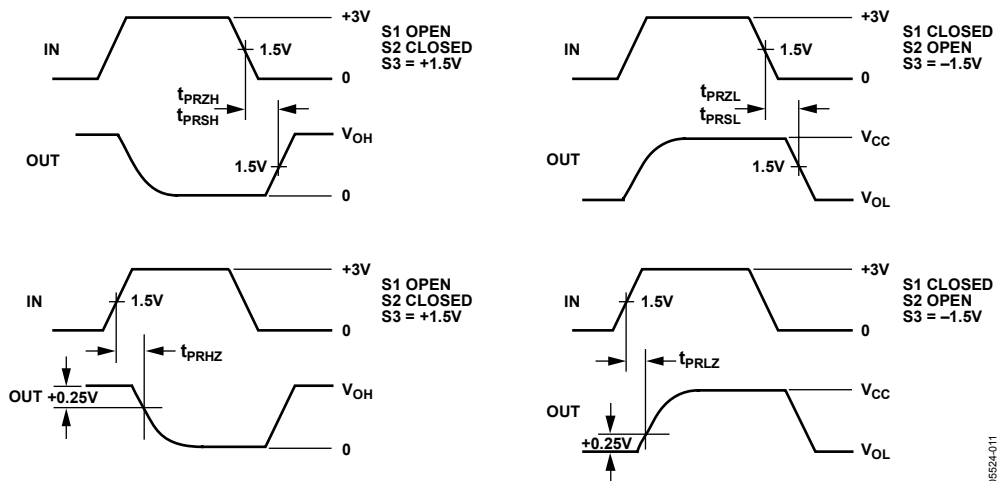

Figure 21. Receiver Enable and Disable Times

TYPICAL PERFORMANCE CHARACTERISTICS

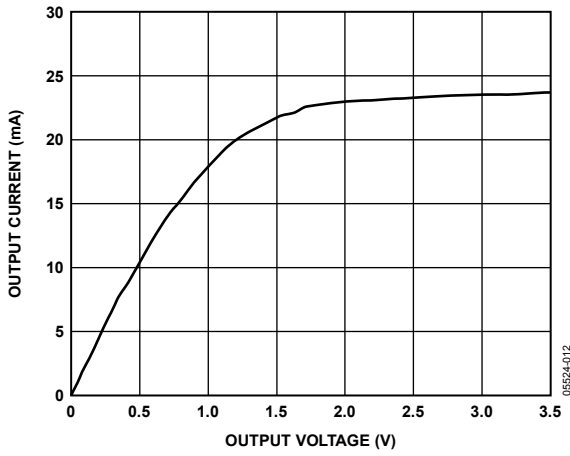

Figure 22. Output Current vs. Receiver Output Low Voltage

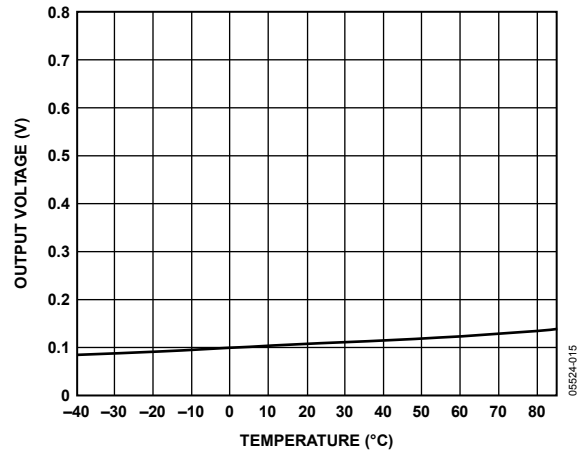

Figure 25. Receiver Output Low Voltage vs. Temperature, $I_{RO} = 2.5 \text{ mA}$

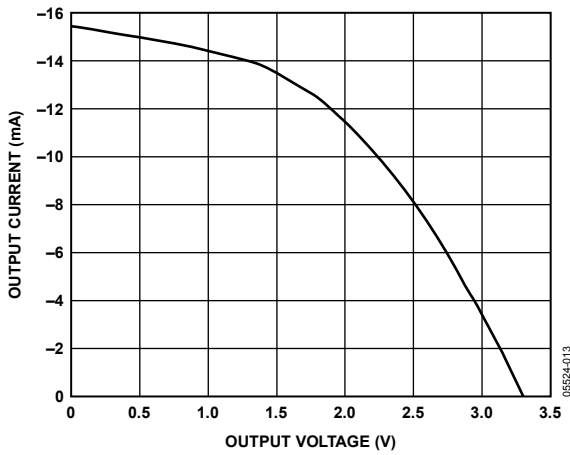

Figure 23. Output Current vs. Receiver Output High Voltage

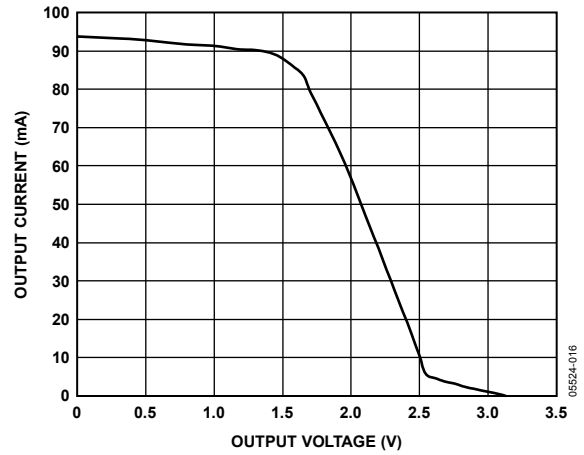

Figure 26. Driver Output Current vs. Differential Output Voltage

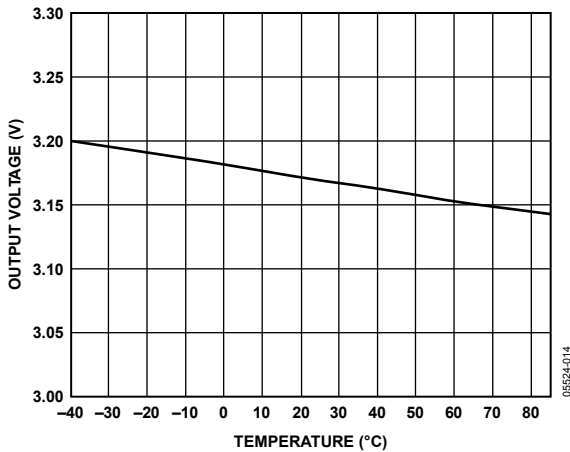

Figure 24. Receiver Output High Voltage vs. Temperature, $I_{RO} = 1.5 \text{ mA}$

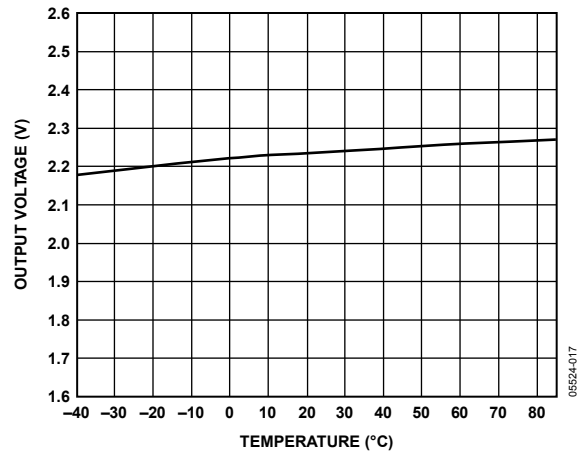

Figure 27. Driver Differential Output Voltage vs. Temperature, $R_L = 54 \Omega$

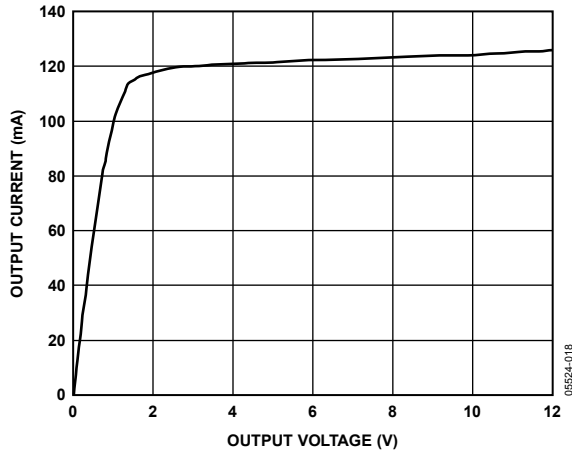

Figure 28. Output Current vs. Driver Output Low Voltage

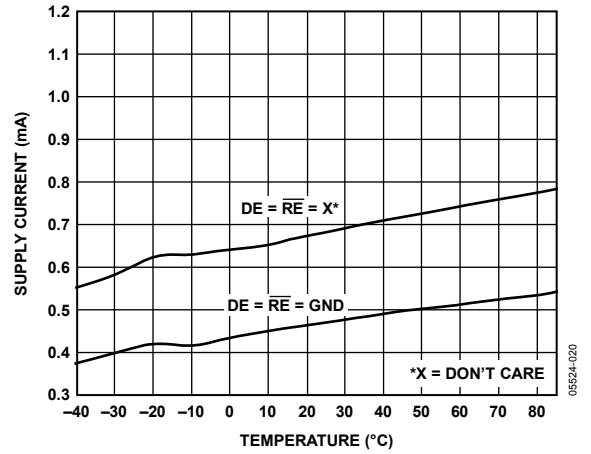

Figure 30. Supply Current vs. Temperature

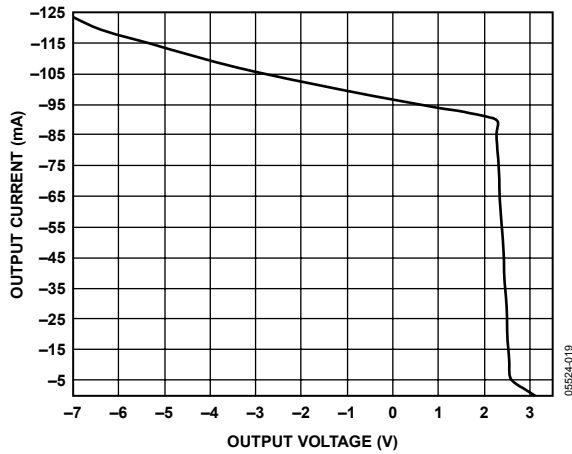

Figure 29. Output Current vs. Driver Output High Voltage

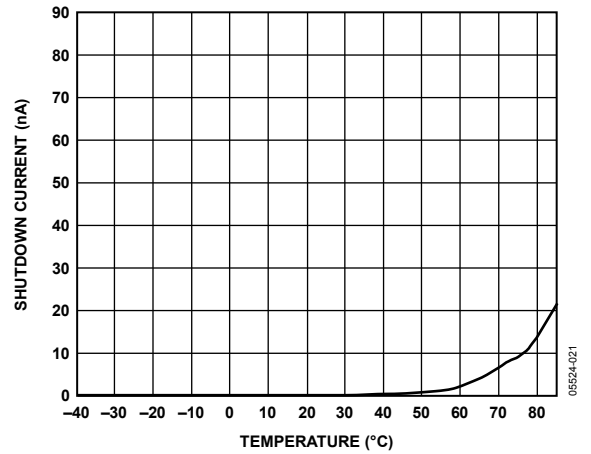

Figure 31. Shutdown Current vs. Temperature

ADM3483/ADM3485/ADM3488/ADM3490/ADM3491

CIRCUIT DESCRIPTION

The ADM3483/ADM3485/ADM3488/ADM3490/ADM3491 are low power transceivers for RS-485 and RS-422 communications. The ADM3483/ADM3488 transmit and receive at data rates up to 250 kbps; the ADM3485/ADM3490/ADM3491 transmit at up to 10 Mbps. The ADM3488/ADM3490/ADM3491 are full-duplex transceivers, while the ADM3483/ADM3485 are half-duplex transceivers. Driver enable (DE) and receiver enable ($\overline{\text{RE}}$) pins are included on the ADM3483/ADM3485/ADM3491. When disabled, the driver and receiver outputs are high impedance.

DEVICES WITH RECEIVER/DRIVER ENABLES— ADM3483/ADM3485/ADM3491

Table 8. Transmitting Truth Table

Transmitting Input			Transmitting Output		Mode
$\overline{\text{RE}}$	DE	DI	B ¹	A ¹	
X ²	1	1	0	1	Normal
X ²	1	0	1	0	Normal
0	0	X ²	High-Z ³	High-Z ³	Normal
1	0	X ²	High-Z ³	High-Z ³	Shutdown

¹ A and B outputs are Z and Y respectively, for full-duplex part (ADM3491).

² X = don't care.

³ High-Z = high impedance.

Table 9. Receiving Truth Table

Receiving Input			Receiving Output	Mode
$\overline{\text{RE}}$	DE ¹	A – B	RO	
0	0	$\geq +0.2\text{ V}$	1	Normal
0	0	$\leq -0.2\text{ V}$	0	Normal
0	0	Inputs Open	1	Normal
1	0	X ²	High-Z ³	Shutdown

¹ DE is a don't care; X for the full-duplex part (ADM3491).

² X = don't care.

³ High-Z = high impedance.

DEVICES WITHOUT RECEIVER/DRIVER ENABLES— ADM3488/ADM3490

Table 10. Transmitting Truth Table

Transmitting Input	Transmitting Output	
DI	Z	Y
1	0	1
0	1	0

Table 11. Receiving Truth Table

Receiving Input	Receiving Output
A – B	RO
$\geq +0.2\text{ V}$	1
$\leq -0.2\text{ V}$	0
Inputs open	1

REDUCED EMI AND REFLECTIONS— ADM3483/ADM3488

The ADM3483/ADM3488 are slow rate limited transceivers, minimizing EMI and reducing reflections caused by improperly terminated cables.

LOW POWER SHUTDOWN MODE (ADM3483/ADM3485/ADM3491)

A low power shutdown mode is initiated by bringing $\overline{\text{RE}}$ high and DE low. The devices do not shut down unless both the driver and receiver are disabled (high impedance). In shutdown mode, the devices typically draw only 2 nA of supply current. For these devices, the t_{PSH} and t_{PSL} enable times assume the part is in the low power shutdown mode; the t_{PZH} and t_{PZL} enable times assume the receiver or driver was disabled, but the part is not shut down.

DRIVER OUTPUT PROTECTION

Two methods are implemented to prevent excessive output current and power dissipation caused by faults or by bus contention. Current limit protection on the output stage provides immediate protection against short circuits over the whole common-mode voltage range (see the Typical Performance Characteristics section). In addition, a thermal shutdown circuit forces the driver outputs into a high impedance state if the die temperature rises excessively.

PROPAGATION DELAY

Skew time is the difference between the low-to-high and high-to-low propagation delays. Small driver/receiver skew times help maintain a symmetrical mark-space ratio (50% duty cycle). The receiver skew time ($|t_{\text{PRLH}} - t_{\text{PRHL}}|$) is under 10 ns (20 ns for ADM3483/ADM3488). The driver skew times are 8 ns for ADM3485/ADM3490/ADM3491 and typically under 100 ns for ADM3483/ADM3488.

TYPICAL APPLICATIONS

The ADM3483/ADM3485/ADM3491 transceivers are designed for half-duplex bidirectional data communications on multipoint bus transmission lines, Figure 32 and Figure 33 show typical network applications circuits. The ADM3488 and the ADM3490 full-duplex transceivers are designed to be used in a daisy-chain network topology or in a point-to-point application, see Figure 34 and Figure 35. The ADM3491 can be used as line repeat Figure 36. To minimize reflections, the line must be terminated at both ends in its characteristic impedance, and stub lengths off the main line must be kept as short as possible. The slow rate limited ADM3483/ADM3488 are more tolerant of imperfect termination.

LINE LENGTH VS. DATA RATE

The RS-485 and RS-422 standards cover line lengths up to 4000 feet. For line lengths greater than 4000 feet, see Figure 36.

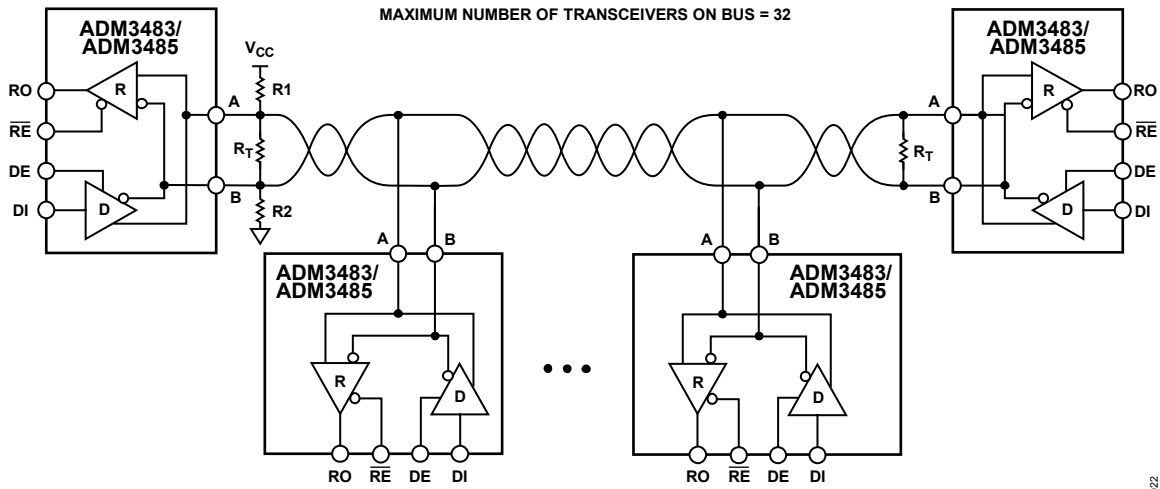

NOTES
1. R_T IS EQUAL TO THE CHARACTERISTIC IMPEDANCE OF THE CABLE.

Figure 32. ADM3483/ADM3485 Typical Half-Duplex RS-485 Network

05524-022

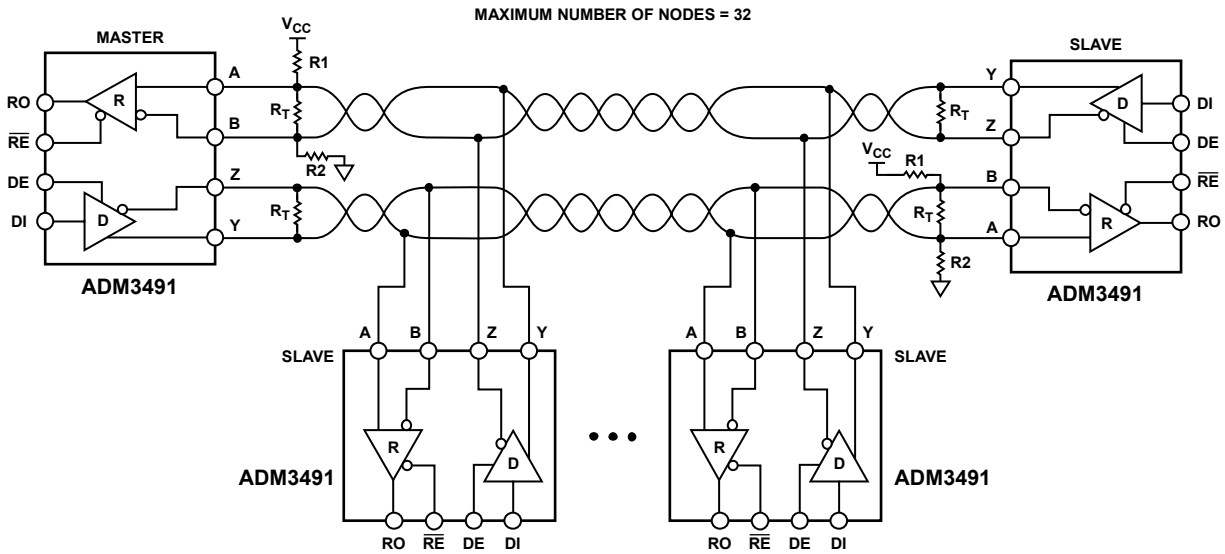

NOTES
1. R_T IS EQUAL TO THE CHARACTERISTIC IMPEDANCE OF THE CABLE.

Figure 33. ADM3491 Typical Full-Duplex RS-485 Network

05524-090

ADM3483/ADM3485/ADM3488/ADM3490/ADM3491

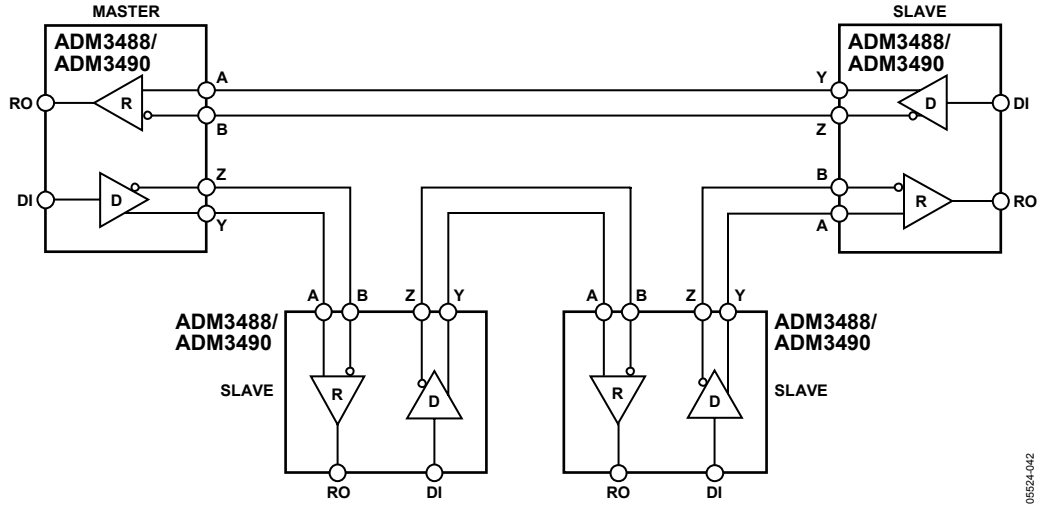

Figure 34. ADM3488/ADM3490 Full-Duplex Daisy-Chain Network

05524-042

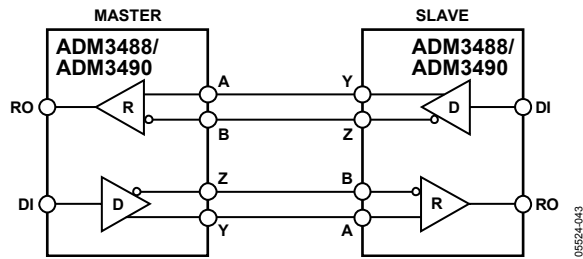
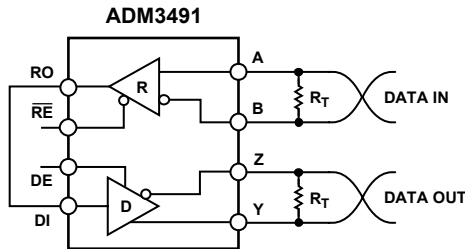

Figure 35. ADM3488/ADM3490 Full-Duplex Point-to-Point Applications

05524-043



NOTES
1. R_T IS EQUAL TO THE CHARACTERISTIC IMPEDANCE OF THE CABLE.

Figure 36. Line Repeater for ADM3491

05524-081

ADM3483/ADM3485/ADM3488/ADM3490/ADM3491

ORDERING GUIDE

Model	Temperature Range	Package Description	Package Option	Ordering Quantity
ADM3483ARZ ¹	-40°C to +85°C	8-Lead Narrow Body Small Outline (SOIC_N)	R-8	
ADM3483ARZ-REEL7 ¹	-40°C to +85°C	8-Lead Narrow Body Small Outline (SOIC_N)	R-8	1,000
ADM3485ARZ ¹	-40°C to +85°C	8-Lead Narrow Body Small Outline (SOIC_N)	R-8	
ADM3485ARZ-REEL7 ¹	-40°C to +85°C	8-Lead Narrow Body Small Outline (SOIC_N)	R-8	1,000
ADM3488ARZ ¹	-40°C to +85°C	8-Lead Narrow Body Small Outline (SOIC_N)	R-8	
ADM3488ARZ-REEL7 ¹	-40°C to +85°C	8-Lead Narrow Body Small Outline (SOIC_N)	R-8	1,000
ADM3490ARZ ¹	-40°C to +85°C	8-Lead Narrow Body Small Outline (SOIC_N)	R-8	
ADM3490ARZ-REEL7 ¹	-40°C to +85°C	8-Lead Narrow Body Small Outline (SOIC_N)	R-8	1,000
ADM3491AR	-40°C to +85°C	14-Lead Narrow Body Small Outline (SOIC_N)	R-14	
ADM3491AR-REEL	-40°C to +85°C	14-Lead Narrow Body Small Outline (SOIC_N)	R-14	2,500
ADM3491AR-REEL7	-40°C to +85°C	14-Lead Narrow Body Small Outline (SOIC_N)	R-14	1,000
ADM3491ARZ ¹	-40°C to +85°C	14-Lead Narrow Body Small Outline (SOIC_N)	R-14	
ADM3491ARZ-REEL ¹	-40°C to +85°C	14-Lead Narrow Body Small Outline (SOIC_N)	R-14	2,500
ADM3491ARZ-REEL7 ¹	-40°C to +85°C	14-Lead Narrow Body Small Outline (SOIC_N)	R-14	1,000

¹ Z = Pb-free part.

NOTES

NOTES