

FEATURES

Single- or dual-supply operation
Low noise: 4.7 nV/ $\sqrt{\text{Hz}}$ @ 1 kHz
Wide bandwidth: 3.4 MHz
Low offset voltage: 100 μV
Very low drift: 0.2 $\mu\text{V}/^\circ\text{C}$
Unity gain stable
No phase reversal

APPLICATIONS

Digital scales
Multimedia
Strain gages
Battery-powered instrumentation
Temperature transducer amplifier

GENERAL DESCRIPTION

The OPx13 family of single-supply operational amplifiers features both low noise and drift. It has been designed for systems with internal calibration. Often these processor-based systems are capable of calibrating corrections for offset and gain, but they cannot correct for temperature drifts and noise. Optimized for these parameters, the OPx13 family can be used to take advantage of superior analog performance combined with digital correction. Many systems using internal calibration operate from unipolar supplies, usually either 5 V or 12 V. The OPx13 family is designed to operate from single supplies from 4 V to 36 V and to maintain its low noise and precision performance.

The OPx13 family is unity gain stable and has a typical gain bandwidth product of 3.4 MHz. Slew rate is in excess of 1 V/ μs . Noise density is a very low 4.7 nV/ $\sqrt{\text{Hz}}$, and noise in the 0.1 Hz to 10 Hz band is 120 nV p-p. Input offset voltage is guaranteed and offset drift is guaranteed to be less than 0.8 $\mu\text{V}/^\circ\text{C}$. Input common-mode range includes the negative supply and to within 1 V of the positive supply over the full supply range. Phase reversal protection is designed into the OPx13 family for cases where input voltage range is exceeded. Output voltage swings also include the negative supply and go to within 1 V of the positive rail. The output is capable of sinking and sourcing current throughout its range and is specified with 600 Ω loads.

PIN CONFIGURATIONS

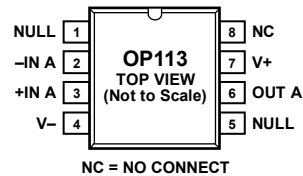

Figure 1. 8-Lead Narrow-Body SOIC_N

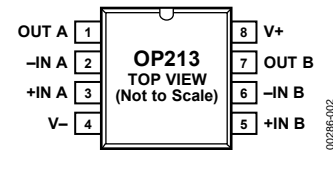

Figure 2. 8-Lead Narrow-Body SOIC_N

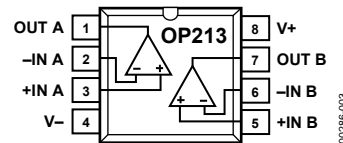

Figure 3. 8-Lead PDIP

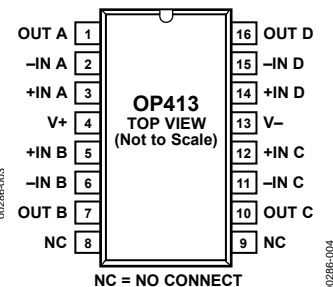

Figure 4. 16-Lead Wide-Body SOIC_W

Digital scales and other strain gage applications benefit from the very low noise and low drift of the OPx13 family. Other applications include use as a buffer or amplifier for both analog-to-digital (ADC) and digital-to-analog (DAC) sigma-delta converters. Often these converters have high resolutions requiring the lowest noise amplifier to utilize their full potential. Many of these converters operate in either single-supply or low-supply voltage systems, and attaining the greater signal swing possible increases system performance.

The OPx13 family is specified for single 5 V and dual ± 15 V operation over the XIND—extended industrial temperature range (-40°C to $+85^\circ\text{C}$). They are available in PDIP and SOIC surface-mount packages.

Rev. F

Information furnished by Analog Devices is believed to be accurate and reliable. However, no responsibility is assumed by Analog Devices for its use, nor for any infringements of patents or other rights of third parties that may result from its use. Specifications subject to change without notice. No license is granted by implication or otherwise under any patent or patent rights of Analog Devices. Trademarks and registered trademarks are the property of their respective owners.

TABLE OF CONTENTS

Features 1

Applications..... 1

General Description 1

Pin Configurations 1

Revision History 2

Specifications..... 3

 Electrical Characteristics 3

Absolute Maximum Ratings..... 6

 Thermal Resistance 6

 ESD Caution..... 6

Typical Performance Characteristics 7

Applications..... 13

 Phase Reversal..... 13

 OP113 Offset Adjust 13

Application Circuits 14

 A High Precision Industrial Load-Cell Scale Amplifier..... 14

A Low Voltage, Single Supply Strain Gage Amplifier..... 14

A High Accuracy Linearized RTD Thermometer Amplifier 14

A High Accuracy Thermocouple Amplifier 15

An Ultralow Noise, Single Supply Instrumentation Amplifier 15

Supply Splitter Circuit..... 15

Low Noise Voltage Reference..... 16

5 V Only Stereo DAC for Multimedia 16

Low Voltage Headphone Amplifiers..... 17

Low Noise Microphone Amplifier for Multimedia 17

Precision Voltage Comparator..... 17

Outline Dimensions 19

Ordering Guide 20

REVISION HISTORY

3/07—Rev. E to Rev. F

Updated Format..... Universal

Changes to Pin Configurations..... 1

Changes to Absolute Maximum Ratings Section 6

Deleted Spice Model..... 15

Updated Outline Dimensions 19

Changes to Ordering Guide 20

8/02—Rev. D to Rev. E

Edits to Figure 6 13

Edits to Figure 7 13

Edits to OUTLINE DIMENSIONS 16

9/01—Rev. C to Rev. E

Edits to ORDERING GUIDE..... 4

SPECIFICATIONS

ELECTRICAL CHARACTERISTICS

@ $V_S = \pm 15.0\text{ V}$, $T_A = 25^\circ\text{C}$, unless otherwise noted.

Table 1.

Parameter	Symbol	Conditions	E Grade			F Grade			Unit
			Min	Typ	Max	Min	Typ	Max	
INPUT CHARACTERISTICS									
Offset Voltage	V_{OS}	OP113 $-40^\circ\text{C} \leq T_A \leq +85^\circ\text{C}$			75			150	μV
		$-40^\circ\text{C} \leq T_A \leq +85^\circ\text{C}$			125			225	μV
		OP213 $-40^\circ\text{C} \leq T_A \leq +85^\circ\text{C}$			100			250	μV
		$-40^\circ\text{C} \leq T_A \leq +85^\circ\text{C}$			150			325	μV
		OP413 $-40^\circ\text{C} \leq T_A \leq +85^\circ\text{C}$			125			275	μV
		$-40^\circ\text{C} \leq T_A \leq +85^\circ\text{C}$			175			350	μV
Input Bias Current	I_B	$V_{CM} = 0\text{ V}$ $-40^\circ\text{C} \leq T_A \leq +85^\circ\text{C}$		240	600			600	nA
		$-40^\circ\text{C} \leq T_A \leq +85^\circ\text{C}$			700			700	nA
Input Offset Current	I_{OS}	$V_{CM} = 0\text{ V}$ $-40^\circ\text{C} \leq T_A \leq +85^\circ\text{C}$			50			50	nA
Input Voltage Range	V_{CM}		-15		+14	-15		+14	V
Common-Mode Rejection	CMR	$-15\text{ V} \leq V_{CM} \leq +14\text{ V}$ $-15\text{ V} \leq V_{CM} \leq +14\text{ V}$, $-40^\circ\text{C} \leq T_A \leq +85^\circ\text{C}$	100	116		96			dB
		$-40^\circ\text{C} \leq T_A \leq +85^\circ\text{C}$	97	116		94			dB
Large-Signal Voltage Gain	A_{VO}	OP113, OP213, $R_L = 600\ \Omega$, $-40^\circ\text{C} \leq T_A \leq +85^\circ\text{C}$	1	2.4		1			V/ μV
		OP413, $R_L = 1\text{ k}\Omega$, $-40^\circ\text{C} \leq T_A \leq +85^\circ\text{C}$	1	2.4		1			V/ μV
		$R_L = 2\text{ k}\Omega$, $-40^\circ\text{C} \leq T_A \leq +85^\circ\text{C}$	2	8		2			V/ μV
Long-Term Offset Voltage ¹	V_{OS}				150			300	μV
Offset Voltage Drift ²	$\Delta V_{OS}/\Delta T$			0.2	0.8			1.5	$\mu\text{V}/^\circ\text{C}$
OUTPUT CHARACTERISTICS									
Output Voltage Swing High	V_{OH}	$R_L = 2\text{ k}\Omega$ $R_L = 2\text{ k}\Omega$, $-40^\circ\text{C} \leq T_A \leq +85^\circ\text{C}$	14			14			V
		$-40^\circ\text{C} \leq T_A \leq +85^\circ\text{C}$	13.9			13.9			V
Output Voltage Swing Low	V_{OL}	$R_L = 2\text{ k}\Omega$ $R_L = 2\text{ k}\Omega$, $-40^\circ\text{C} \leq T_A \leq +85^\circ\text{C}$			-14.5			-14.5	V
		$-40^\circ\text{C} \leq T_A \leq +85^\circ\text{C}$			-14.5			-14.5	V
Short-Circuit Limit	I_{SC}			± 40			± 40		mA
POWER SUPPLY									
Power Supply Rejection Ratio	PSRR	$V_S = \pm 2\text{ V}$ to $\pm 18\text{ V}$ $V_S = \pm 2\text{ V}$ to $\pm 18\text{ V}$ $-40^\circ\text{C} \leq T_A \leq +85^\circ\text{C}$	103	120		100			dB
		$-40^\circ\text{C} \leq T_A \leq +85^\circ\text{C}$	100	120		97			dB
Supply Current/Amplifier	I_{SY}	$V_{OUT} = 0\text{ V}$, $R_L = \infty$, $V_S = \pm 18\text{ V}$ $-40^\circ\text{C} \leq T_A \leq +85^\circ\text{C}$			3			3	mA
		$-40^\circ\text{C} \leq T_A \leq +85^\circ\text{C}$			3.8			3.8	mA
Supply Voltage Range	V_S		4		± 18	4		± 18	V

OP113/OP213/OP413

Parameter	Symbol	Conditions	E Grade			F Grade			Unit
			Min	Typ	Max	Min	Typ	Max	
AUDIO PERFORMANCE									
THD + Noise		$V_{IN} = 3\text{ V rms}, R_L = 2\text{ k}\Omega,$ $f = 1\text{ kHz}$		0.0009			0.0009		%
Voltage Noise Density	e_n	$f = 10\text{ Hz}$		9			9		nV/ $\sqrt{\text{Hz}}$
Current Noise Density	i_n	$f = 1\text{ kHz}$		4.7			4.7		nV/ $\sqrt{\text{Hz}}$
Voltage Noise	e_n p-p	$f = 1\text{ kHz}$		0.4			0.4		pA/ $\sqrt{\text{Hz}}$
		0.1 Hz to 10 Hz		120			120		nV p-p
DYNAMIC PERFORMANCE									
Slew Rate	SR	$R_L = 2\text{ k}\Omega$	0.8	1.2		0.8	1.2		V/ μs
Gain Bandwidth Product	GBP			3.4			3.4		MHz
Channel Separation		$V_{OUT} = 10\text{ V p-p}$ $R_L = 2\text{ k}\Omega, f = 1\text{ kHz}$		105			105		dB
Settling Time	t_s	to 0.01%, 0V to 10V step		9			9		μs

¹ Long-term offset voltage is guaranteed by a 1000 hour life test performed on three independent lots at 125°C, with an LTPD of 1.3.

² Guaranteed specifications, based on characterization data.

@ $V_S = 5.0\text{ V}, T_A = 25^\circ\text{C}$, unless otherwise noted.

Table 2.

Parameter	Symbol	Conditions	E Grade			F Grade			Unit
			Min	Typ	Max	Min	Typ	Max	
INPUT CHARACTERISTICS									
Offset Voltage	V_{OS}	OP113			125			175	μV
		$-40^\circ\text{C} \leq T_A \leq +85^\circ\text{C}$			175			250	μV
		OP213			150			300	μV
		$-40^\circ\text{C} \leq T_A \leq +85^\circ\text{C}$			225			375	μV
		OP413			175			325	μV
Input Bias Current	I_B	$-40^\circ\text{C} \leq T_A \leq +85^\circ\text{C}$			250			400	μV
		$V_{CM} = 0\text{ V}, V_{OUT} = 2$		300	650		650	nA	
		$-40^\circ\text{C} \leq T_A \leq +85^\circ\text{C}$			750		750	nA	
Input Offset Current	I_{OS}	$V_{CM} = 0\text{ V}, V_{OUT} = 2$ $-40^\circ\text{C} \leq T_A \leq +85^\circ\text{C}$			50		50	nA	
Input Voltage Range	V_{CM}		0		4		4	V	
Common-Mode Rejection	CMR	$0\text{ V} \leq V_{CM} \leq 4\text{ V}$	93	106		90			dB
		$0\text{ V} \leq V_{CM} \leq 4\text{ V},$ $-40^\circ\text{C} \leq T_A \leq +85^\circ\text{C}$	90			87			dB
Large-Signal Voltage Gain	A_{VO}	OP113, OP213, $R_L = 600\ \Omega, 2\text{ k}\Omega,$ $0.01\text{ V} \leq V_{OUT} \leq 3.9\text{ V}$	2			2			V/ μV
		OP413, $R_L = 600, 2\text{ k}\Omega,$ $0.01\text{ V} \leq V_{OUT} \leq 3.9\text{ V}$	1			1			V/ μV
Long-Term Offset Voltage ¹	V_{OS}				200		350	μV	
Offset Voltage Drift ²	$\Delta V_{OS}/\Delta T$			0.2	1.0		1.5	$\mu\text{V}/^\circ\text{C}$	

Parameter	Symbol	Conditions	E Grade			F Grade			Unit
			Min	Typ	Max	Min	Typ	Max	
OUTPUT CHARACTERISTICS									
Output Voltage Swing High	V_{OH}	$R_L = 600\text{ k}\Omega$	4.0			4.0			V
		$R_L = 100\text{ k}\Omega,$	4.1			4.1			V
		$-40^\circ\text{C} \leq T_A \leq +85^\circ\text{C}$							
Output Voltage Swing Low	V_{OL}	$R_L = 600\ \Omega,$	3.9			3.9			V
		$-40^\circ\text{C} \leq T_A \leq +85^\circ\text{C}$							
		$R_L = 600\ \Omega,$			8			8	mV
		$-40^\circ\text{C} \leq T_A \leq +85^\circ\text{C}$							
		$R_L = 100\text{ k}\Omega,$							mV
		$-40^\circ\text{C} \leq T_A \leq +85^\circ\text{C}$							
Short-Circuit Limit	I_{SC}			8			8		mV
				± 30			± 30		mA
POWER SUPPLY									
Supply Current	I_{SY}	$V_{OUT} = 2.0\text{ V},$ no load		1.6	2.7			2.7	mA
	I_{SY}	$-40^\circ\text{C} \leq T_A \leq +85^\circ\text{C}$			3.0			3.0	mA
AUDIO PERFORMANCE									
THD + Noise		$V_{OUT} = 0\text{ dBu},$ $f = 1\text{ kHz}$		0.001			0.001		%
Voltage Noise Density	e_n	$f = 10\text{ Hz}$		9			9		nV/ $\sqrt{\text{Hz}}$
		$f = 1\text{ kHz}$		4.7			4.7		nV/ $\sqrt{\text{Hz}}$
Current Noise Density	i_n	$f = 1\text{ kHz}$		0.45			0.45		pA/ $\sqrt{\text{Hz}}$
Voltage Noise	e_n p-p	0.1 Hz to 10 Hz		120			120		nV p-p
DYNAMIC PERFORMANCE									
Slew Rate	SR	$R_L = 2\text{ k}\Omega$	0.6	0.9		0.6			V/ μs
Gain Bandwidth Product	GBP			3.5			3.5		MHz
Settling Time	t_s	to 0.01%, 2 V step		5.8			5.8		μs

¹ Long-term offset voltage is guaranteed by a 1000 hour life test performed on three independent lots at 125°C, with an LTPD of 1.3.

² Guaranteed specifications, based on characterization data.

ABSOLUTE MAXIMUM RATINGS

Table 3.

Parameter	Rating
Supply Voltage	±18 V
Input Voltage	±18 V
Differential Input Voltage	±10 V
Output Short-Circuit Duration to GND	Indefinite
Storage Temperature Range	−65°C to +150°C
Operating Temperature Range	−40°C to +85°C
Junction Temperature Range	−65°C to +150°C
Lead Temperature Range (Soldering, 60 sec)	300°C

Stresses above those listed under Absolute Maximum Ratings may cause permanent damage to the device. This is a stress rating only; functional operation of the device at these or any other conditions above those indicated in the operational section of this specification is not implied. Exposure to absolute maximum rating conditions for extended periods may affect device reliability.

THERMAL RESISTANCE

Table 4. Thermal Resistance

Package Type	θ_{JA}	θ_{JC}	Unit
8-Lead PDIP (P)	103	43	°C/W
8-Lead SOIC_N (S)	158	43	°C/W
16-Lead SOIC_W (S)	92	27	°C/W

ESD CAUTION



ESD (electrostatic discharge) sensitive device.

Charged devices and circuit boards can discharge without detection. Although this product features patented or proprietary protection circuitry, damage may occur on devices subjected to high energy ESD. Therefore, proper ESD precautions should be taken to avoid performance degradation or loss of functionality.

TYPICAL PERFORMANCE CHARACTERISTICS



Figure 5. OP113 Input Offset (V_{OS}) Distribution @ ± 15 V



Figure 8. OP113 Temperature Drift (TCV_{OS}) Distribution @ ± 15 V

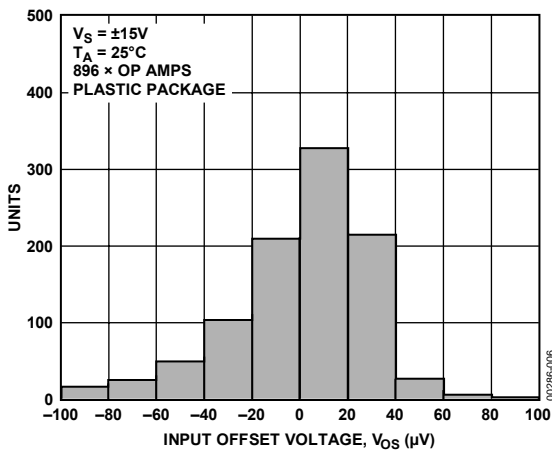

Figure 6. OP213 Input Offset (V_{OS}) Distribution @ ± 15 V



Figure 9. OP213 Temperature Drift (TCV_{OS}) Distribution @ ± 15 V



Figure 7. OP413 Input Offset (V_{OS}) Distribution @ ± 15 V



Figure 10. OP413 Temperature Drift (TCV_{OS}) Distribution @ ± 15 V

OP113/OP213/OP413



Figure 11. OP113 Input Bias Current vs. Temperature



Figure 14. OP213 Input Bias Current vs. Temperature



Figure 12. Output Swing vs. Temperature and R_L @ 5V



Figure 15. Output Swing vs. Temperature and R_L @ $\pm 15V$

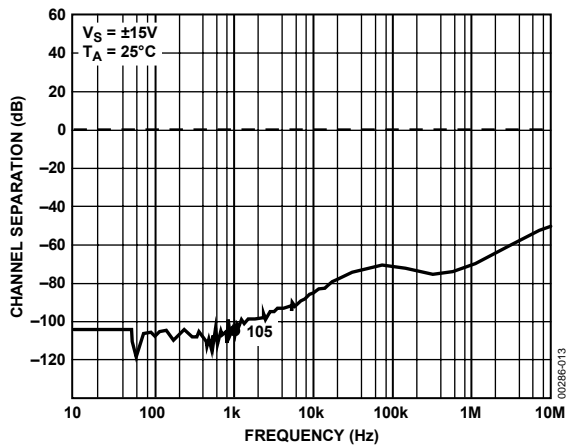

Figure 13. Channel Separation

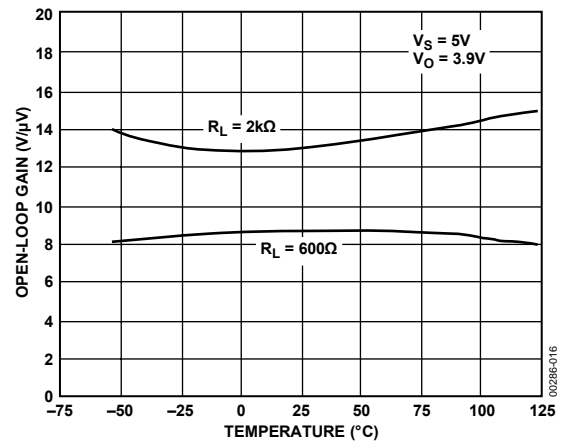

Figure 16. Open-Loop Gain vs. Temperature @ 5V



Figure 17. OP413 Open-Loop Gain vs. Temperature



Figure 20. OP213 Open-Loop Gain vs. Temperature



Figure 18. Open-Loop Gain, Phase vs. Frequency @ 5 V



Figure 21. Open-Loop Gain, Phase vs. Frequency @ ±15 V



Figure 19. Closed-Loop Gain vs. Frequency @ 5 V



Figure 22. Closed-Loop Gain vs. Frequency @ ±15 V

OP113/OP213/OP413



Figure 23. Gain Bandwidth Product and Phase Margin vs. Temperature @ 5 V



Figure 26. Gain Bandwidth Product and Phase Margin vs. Temperature @ ±15 V



Figure 24. Voltage Noise Density vs. Frequency



Figure 27. Current Noise Density vs. Frequency

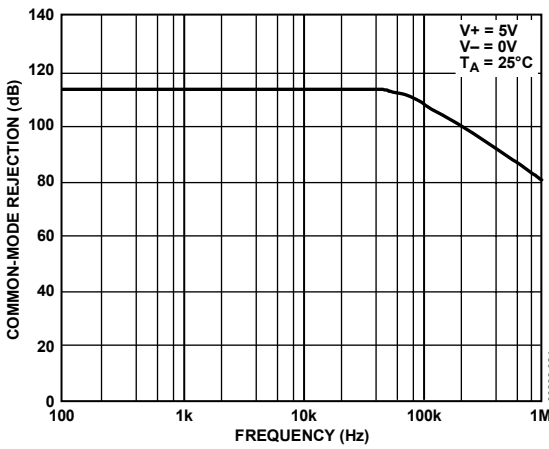

Figure 25. Common-Mode Rejection vs. Frequency @ 5 V

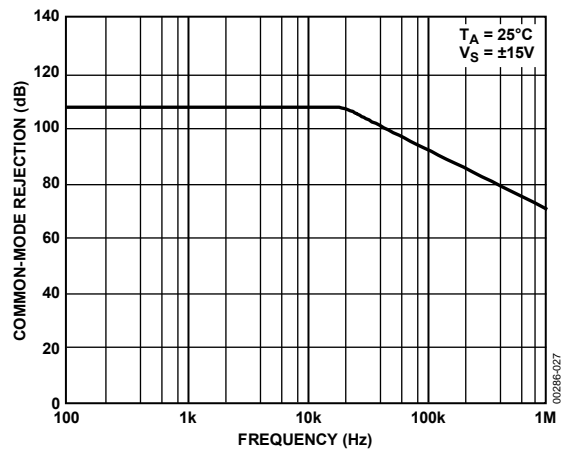

Figure 28. Common-Mode Rejection vs. Frequency @ ±15 V



Figure 29. Power Supply Rejection vs. Frequency @ ±15 V



Figure 32. Closed-Loop Output Impedance vs. Frequency @ ±15 V

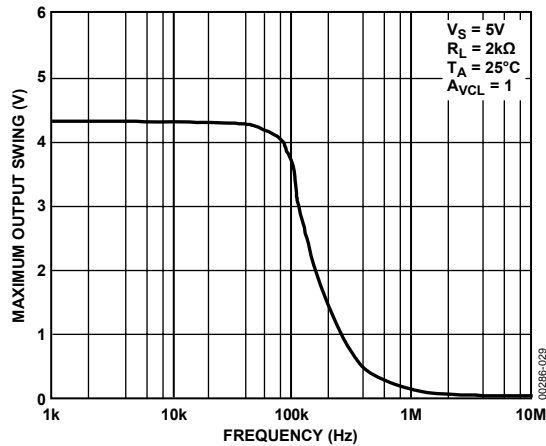

Figure 30. Maximum Output Swing vs. Frequency @ 5 V



Figure 33. Maximum Output Swing vs. Frequency @ ±15 V

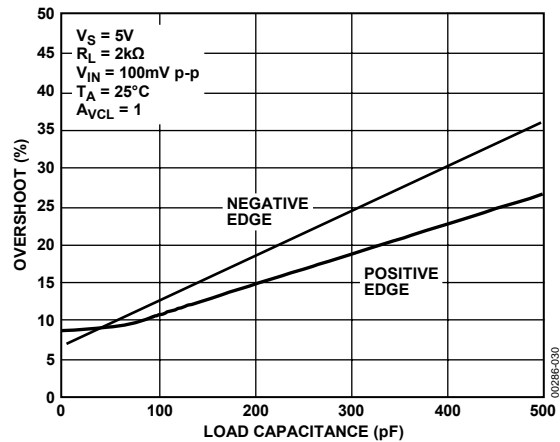

Figure 31. Small-Signal Overshoot vs. Load Capacitance @ 5 V

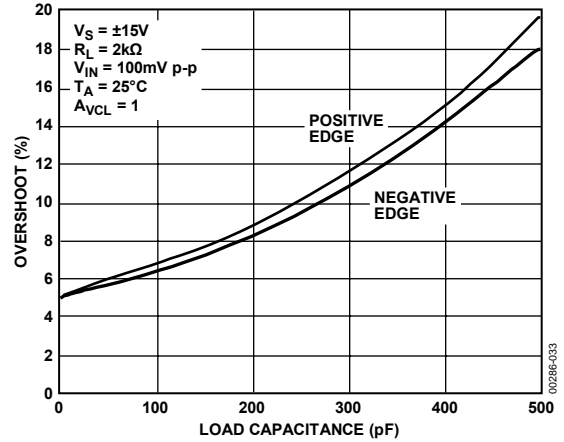

Figure 34. Small-Signal Overshoot vs. Load Capacitance @ ±15 V

OP113/OP213/OP413



Figure 35. Slew Rate vs. Temperature @ 5 V ($0.5\text{ V} \leq V_{OUT} \leq 4.0\text{ V}$)

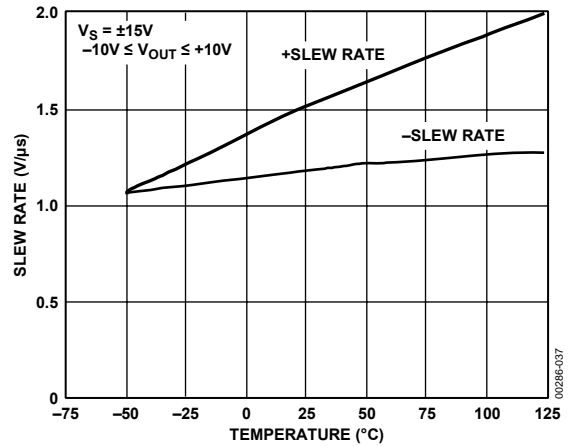

Figure 38. Slew Rate vs. Temperature @ $\pm 15\text{ V}$ ($-10\text{ V} \leq V_{OUT} \leq +10.0\text{ V}$)



Figure 36. Input Voltage Noise @ $\pm 15\text{ V}$ (20 nV/div)

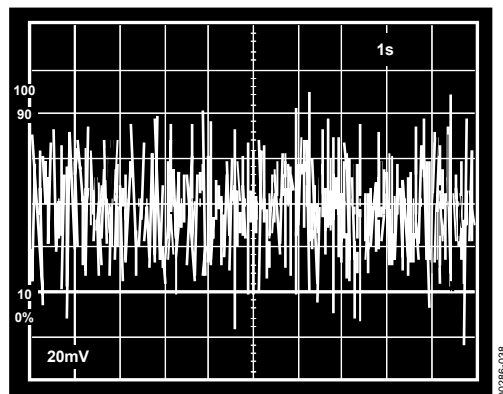

Figure 39. Input Voltage Noise @ 5 V (20 nV/div)

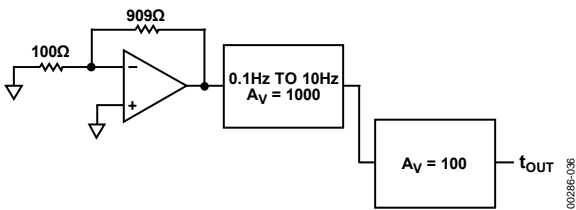

Figure 37. Noise Test Diagram



Figure 40. Supply Current vs. Temperature

APPLICATIONS

The OP113, OP213, and OP413 form a new family of high performance amplifiers that feature precision performance in standard dual-supply configurations and, more importantly, maintain precision performance when a single power supply is used. In addition to accurate dc specifications, it is the lowest noise single-supply amplifier available with only 4.7 nV/√Hz typical noise density.

Single-supply applications have special requirements due to the generally reduced dynamic range of the output signal. Single-supply applications are often operated at voltages of 5 V or 12 V, compared to dual-supply applications with supplies of ±12 V or ±15 V. This results in reduced output swings. Where a dual-supply application may often have 20 V of signal output swing, single-supply applications are limited to, at most, the supply range and, more commonly, several volts below the supply. In order to attain the greatest swing, the single-supply output stage must swing closer to the supply rails than in dual-supply applications.

The OPx13 family has a new patented output stage that allows the output to swing closer to ground, or the negative supply, than previous bipolar output stages. Previous op amps had outputs that could swing to within about 10 mV of the negative supply in single-supply applications. However, the OPx13 family combines both a bipolar and a CMOS device in the output stage, enabling it to swing to within a few hundred μV of ground.

When operating with reduced supply voltages, the input range is also reduced. This reduction in signal range results in reduced signal-to-noise ratio for any given amplifier. There are only two ways to improve this: increase the signal range or reduce the noise. The OPx13 family addresses both of these parameters. Input signal range is from the negative supply to within 1 V of the positive supply over the full supply range. Competitive parts have input ranges that are 0.5 V to 5 V less than this. Noise has also been optimized in the OPx13 family. At 4.7 nV/√Hz, the noise is less than one fourth that of competitive devices.

PHASE REVERSAL

The OPx13 family is protected against phase reversal as long as both of the inputs are within the supply ranges. However, if there is a possibility of either input going below the negative supply (or ground in the single-supply case), the inputs should be protected with a series resistor to limit input current to 2 mA.

OP113 OFFSET ADJUST

The OP113 has the facility for external offset adjustment, using the industry standard arrangement. Pin 1 and Pin 5 are used in conjunction with a potentiometer of 10 kΩ total resistance, connected with the wiper to V₋ (or ground in single-supply applications). The total adjustment range is about ±2 mV using this configuration.

Adjusting the offset to 0 has minimal effect on offset drift (assuming the potentiometer has a tempco of less than 1000 ppm/°C). Adjustment away from 0, however, (as with all bipolar amplifiers) results in a TCV_{OS} of approximately 3.3 μV/°C for every millivolt of induced offset.

It is, therefore, not generally recommended that this trim be used to compensate for system errors originating outside of the OP113. The initial offset of the OP113 is low enough that external trimming is almost never required, but if necessary, the 2 mV trim range may be somewhat excessive. Reducing the trimming potentiometer to a 2 kΩ value results in a more reasonable range of ±400 μV.

APPLICATION CIRCUITS

A HIGH PRECISION INDUSTRIAL LOAD-CELL SCALE AMPLIFIER

The OPx13 family makes an excellent amplifier for conditioning a load-cell bridge. Its low noise greatly improves the signal resolution, allowing the load cell to operate with a smaller output range, thus reducing its nonlinearity. Figure 41 shows one half of the OPx13 family used to generate a very stable 10 V bridge excitation voltage while the second amplifier provides a differential gain. R4 should be trimmed for maximum common-mode rejection.



Figure 41. Precision Load-Cell Scale Amplifier

A LOW VOLTAGE, SINGLE SUPPLY STRAIN GAGE AMPLIFIER

The true zero swing capability of the OPx13 family allows the amplifier in Figure 42 to amplify the strain gage bridge accurately even with no signal input while being powered by a single 5 V supply. A stable 4 V bridge voltage is made possible by the rail-to-rail OP295 amplifier, whose output can swing to within a millivolt of either rail. This high voltage swing greatly increases the bridge output signal without a corresponding increase in bridge input.



Figure 42. Single Supply Strain Gage Amplifier

A HIGH ACCURACY LINEARIZED RTD THERMOMETER AMPLIFIER

Zero suppressing the bridge facilitates simple linearization of the resistor temperature device (RTD) by feeding back a small amount of the output signal to the RTD. In Figure 43, the left leg of the bridge is servoed to a virtual ground voltage by Amplifier A1, and the right leg of the bridge is servoed to 0 V by Amplifier A2. This eliminates any error resulting from common-mode voltage change in the amplifier. A 3-wire RTD is used to balance the wire resistance on both legs of the bridge, thereby reducing temperature mismatch errors. The 5 V bridge excitation is derived from the extremely stable AD588 reference device with 1.5 ppm/°C drift performance.

Linearization of the RTD is done by feeding a fraction of the output voltage back to the RTD in the form of a current. With just the right amount of positive feedback, the amplifier output will be linearly proportional to the temperature of the RTD.

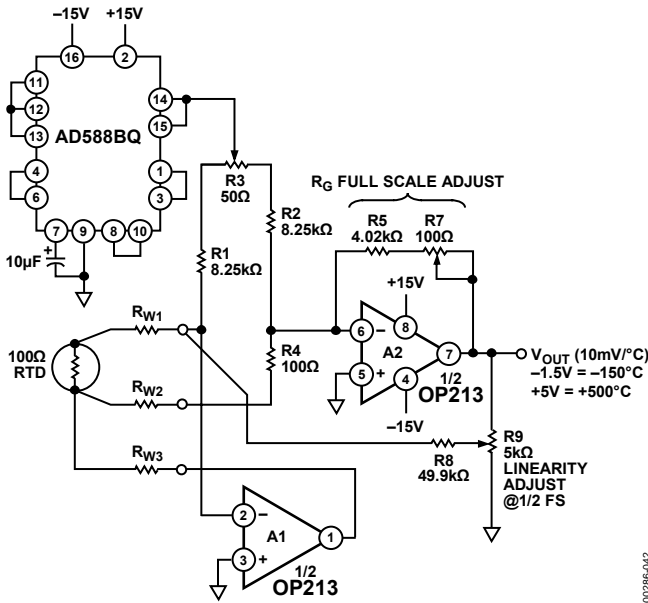

Figure 43. Ultraprecision RTD Amplifier

To calibrate the circuit, first immerse the RTD in a 0°C ice bath or substitute an exact 100 Ω resistor in place of the RTD. Adjust the zero adjust potentiometer for a 0 V output, and then set R9, linearity adjust potentiometer, to the middle of its adjustment range. Substitute a 280.9 Ω resistor (equivalent to 500°C) in place of the RTD, and adjust the full-scale adjust potentiometer for a full-scale voltage of 5 V.

To calibrate out the nonlinearity, substitute a 194.07 Ω resistor (equivalent to 250°C) in place of the RTD, and then adjust the linearity adjust potentiometer for a 2.5 V output. Check and readjust the full-scale and half-scale as needed.

Once calibrated, the amplifier outputs a 10 mV/°C temperature coefficient with an accuracy better than ±0.5°C over an RTD measurement range of -150°C to +500°C. Indeed the amplifier can be calibrated to a higher temperature range, up to 850°C.

A HIGH ACCURACY THERMOCOUPLE AMPLIFIER

Figure 44 shows a popular K-type thermocouple amplifier with cold-junction compensation. Operating from a single 12 V supply, the OPx13 family’s low noise allows temperature measurement to better than 0.02°C resolution over a 0°C to 1000°C range. The cold-junction error is corrected by using an inexpensive silicon diode as a temperature measuring device. It should be placed as close to the two terminating junctions as physically possible. An aluminum block might serve well as an isothermal system.

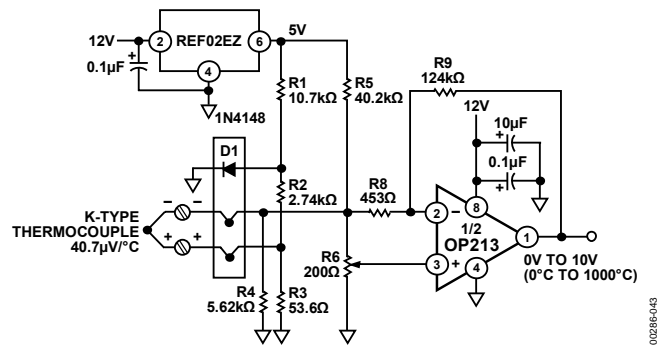
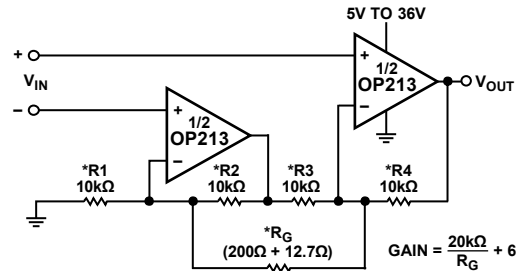

Figure 44. Accurate K-Type Thermocouple Amplifier

R6 should be adjusted for a 0 V output with the thermocouple measuring tip immersed in a 0°C ice bath. When calibrating, be sure to adjust R6 initially to cause the output to swing in the positive direction first. Then back off in the negative direction until the output just stops changing.

AN ULTRALOW NOISE, SINGLE SUPPLY INSTRUMENTATION AMPLIFIER

Extremely low noise instrumentation amplifiers can be built using the OPx13 family. Such an amplifier that operates from a single supply is shown in Figure 45. Resistors R1 to R5 should be of high precision and low drift type to maximize CMRR performance. Although the two inputs are capable of operating to 0 V, the gain of -100 configuration limits the amplifier input common-mode voltage to 0.33 V.



*ALL RESISTORS ±0.1%, ±25ppm/°C.

Figure 45. Ultralow Noise, Single Supply Instrumentation Amplifier

SUPPLY SPLITTER CIRCUIT

The OPx13 family has excellent frequency response characteristics that make it an ideal pseudoground reference generator, as shown in Figure 46. The OPx13 family serves as a voltage follower buffer. In addition, it drives a large capacitor that serves as a charge reservoir to minimize transient load changes, as well as a low impedance output device at high frequencies. The circuit easily supplies 25 mA load current with good settling characteristics.

OP113/OP213/OP413



Figure 46. False Ground Generator

LOW NOISE VOLTAGE REFERENCE

Few reference devices combine low noise and high output drive capabilities. Figure 47 shows the OPx13 family used as a two-pole active filter that band limits the noise of the 2.5 V reference. Total noise measures 3 μ V p-p.

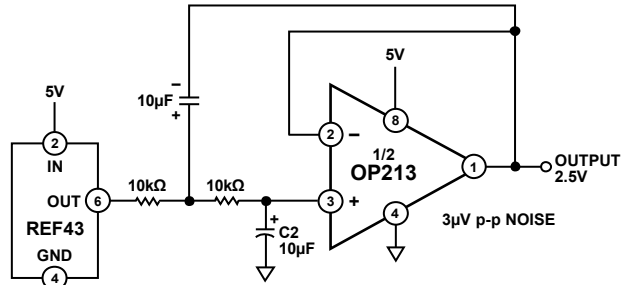

Figure 47. Low Noise Voltage Reference

5 V ONLY STEREO DAC FOR MULTIMEDIA

The OPx13 family's low noise and single supply capability are ideally suited for stereo DAC audio reproduction or sound synthesis applications such as multimedia systems. Figure 48 shows an 18-bit stereo DAC output setup that is powered from a single 5 V supply. The low noise preserves the 18-bit dynamic range of the AD1868. For DACs that operate on dual supplies, the OPx13 family can also be powered from the same supplies.



Figure 48. 5 V Only 18-Bit Stereo DAC

LOW VOLTAGE HEADPHONE AMPLIFIERS

Figure 49 shows a stereo headphone output amplifier for the AD1849 16-bit SOUNDPORT® stereo codec device.¹ The pseudo-reference voltage is derived from the common-mode voltage generated internally by the AD1849, thus providing a convenient bias for the headphone output amplifiers.



Figure 49. Headphone Output Amplifier for Multimedia Sound Codec

LOW NOISE MICROPHONE AMPLIFIER FOR MULTIMEDIA

The OPx13 family is ideally suited as a low noise microphone preamp for low voltage audio applications. Figure 50 shows a gain of 100 stereo preamp for the AD1849 16-bit SOUNDPORT stereo codec chip. The common-mode output buffer serves as a phantom power driver for the microphones.



Figure 50. Low Noise Stereo Microphone Amplifier for Multimedia Sound Codec

PRECISION VOLTAGE COMPARATOR

With its PNP inputs and 0 V common-mode capability, the OPx13 family can make useful voltage comparators. There is only a slight penalty in speed in comparison to IC comparators. However, the significant advantage is its voltage accuracy. For example, V_{OS} can be a few hundred microvolts or less, combined with CMRR and PSRR exceeding 100 dB, while operating from a 5 V supply. Standard comparators like the 111/311 family operate on 5 V, but not with common mode at ground, nor with offset below 3 mV. Indeed, no commercially available single-supply comparator has a V_{OS} less than 200 µV.

¹ SOUNDPORT is a registered trademark of Analog Devices, Inc.

OP113/OP213/OP413

Figure 51 shows the OPx13 family response to a 10 mV overdrive signal when operating in open loop. The top trace shows the output rising edge has a 15 μs propagation delay, whereas the bottom trace shows a 7 μs delay on the output falling edge. This ac response is quite acceptable in many applications.

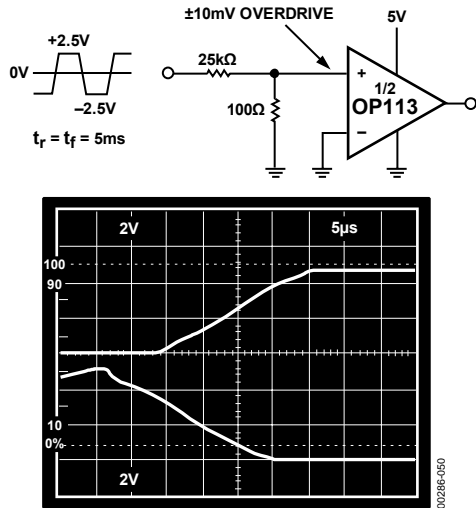

Figure 51. Precision Comparator

The low noise and 250 μV (maximum) offset voltage enhance the overall dc accuracy of this type of comparator. Note that zero-crossing detectors and similar ground referred comparisons can be implemented even if the input swings to -0.3 V below ground.



Figure 52. OP213 Simplified Schematic

OUTLINE DIMENSIONS

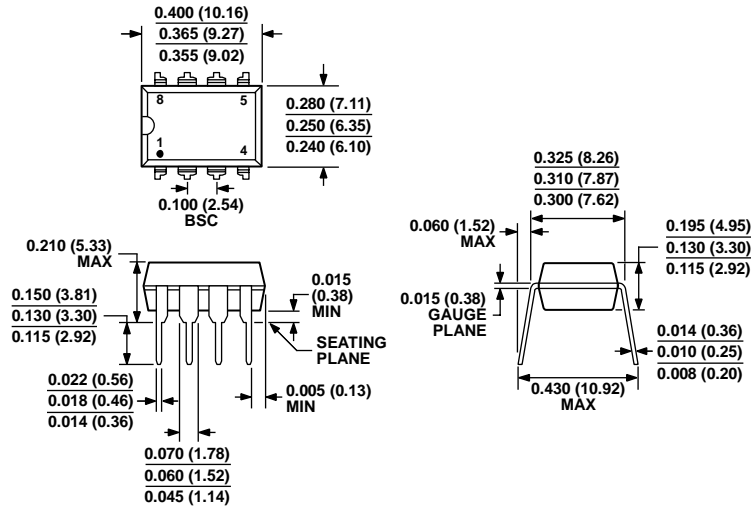

COMPLIANT TO JEDEC STANDARDS MS-001
 CONTROLLING DIMENSIONS ARE IN INCHES; MILLIMETER DIMENSIONS (IN PARENTHESES) ARE ROUNDED-OFF INCH EQUIVALENTS FOR REFERENCE ONLY AND ARE NOT APPROPRIATE FOR USE IN DESIGN. CORNER LEADS MAY BE CONFIGURED AS WHOLE OR HALF LEADS.

Figure 53. 8-Lead Plastic Dual In-Line Package [PDIP]
 Narrow Body
 P-Suffix
 (N-8)
 Dimensions shown in inches and (millimeters)

070606-A

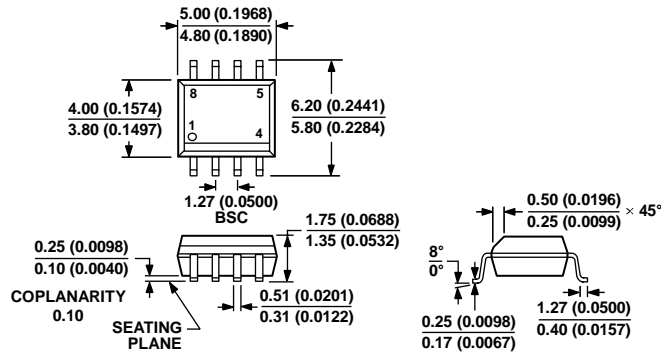

COMPLIANT TO JEDEC STANDARDS MS-012-AA
 CONTROLLING DIMENSIONS ARE IN MILLIMETERS; INCH DIMENSIONS (IN PARENTHESES) ARE ROUNDED-OFF MILLIMETER EQUIVALENTS FOR REFERENCE ONLY AND ARE NOT APPROPRIATE FOR USE IN DESIGN.

Figure 54. 8-Lead Standard Small Outline Package [SOIC_N]
 Narrow Body
 S-Suffix
 (R-8)
 Dimensions shown in millimeters and (inches)

012407-A

OP113/OP213/OP413



COMPLIANT TO JEDEC STANDARDS MS-013-AA
CONTROLLING DIMENSIONS ARE IN MILLIMETERS; INCH DIMENSIONS
(IN PARENTHESES) ARE ROUNDED-OFF MILLIMETER EQUIVALENTS FOR
REFERENCE ONLY AND ARE NOT APPROPRIATE FOR USE IN DESIGN.

Figure 55. 16-Lead Standard Small Outline Package [SOIC_W]
Wide Body
S-Suffix
(RW-16)

Dimensions shown in millimeters and (inches)

030707-B

ORDERING GUIDE

Model	Temperature Range	Package Description	Package Options
OP113ES	-40°C to +85°C	8-Lead SOIC_N	R-8 (S-Suffix)
OP113ES-REEL	-40°C to +85°C	8-Lead SOIC_N	R-8 (S-Suffix)
OP113ES-REEL7	-40°C to +85°C	8-Lead SOIC_N	R-8 (S-Suffix)
OP113ESZ ¹	-40°C to +85°C	8-Lead SOIC_N	R-8 (S-Suffix)
OP113ESZ-REEL ¹	-40°C to +85°C	8-Lead SOIC_N	R-8 (S-Suffix)
OP113ESZ-REEL7 ¹	-40°C to +85°C	8-Lead SOIC_N	R-8 (S-Suffix)
OP113FS	-40°C to +85°C	8-Lead SOIC_N	R-8 (S-Suffix)
OP113FS-REEL	-40°C to +85°C	8-Lead SOIC_N	R-8 (S-Suffix)
OP113FS-REEL7	-40°C to +85°C	8-Lead SOIC_N	R-8 (S-Suffix)
OP113FSZ ¹	-40°C to +85°C	8-Lead SOIC_N	R-8 (S-Suffix)
OP113FSZ-REEL ¹	-40°C to +85°C	8-Lead SOIC_N	R-8 (S-Suffix)
OP113FSZ-REEL7 ¹	-40°C to +85°C	8-Lead SOIC_N	R-8 (S-Suffix)
OP213ES	-40°C to +85°C	8-Lead SOIC_N	R-8 (S-Suffix)
OP213ES-REEL	-40°C to +85°C	8-Lead SOIC_N	R-8 (S-Suffix)
OP213ES-REEL7	-40°C to +85°C	8-Lead SOIC_N	R-8 (S-Suffix)
OP213ESZ ¹	-40°C to +85°C	8-Lead SOIC_N	R-8 (S-Suffix)
OP213ESZ-REEL ¹	-40°C to +85°C	8-Lead SOIC_N	R-8 (S-Suffix)
OP213ESZ-REEL7 ¹	-40°C to +85°C	8-Lead SOIC_N	R-8 (S-Suffix)
OP213FP	-40°C to +85°C	8-Lead PDIP	N-8 (P-Suffix)
OP213FPZ ¹	-40°C to +85°C	8-Lead PDIP	N-8 (P-Suffix)
OP213FS	-40°C to +85°C	8-Lead SOIC_N	R-8 (S-Suffix)
OP213FS-REEL	-40°C to +85°C	8-Lead SOIC_N	R-8 (S-Suffix)
OP213FS-REEL7	-40°C to +85°C	8-Lead SOIC_N	R-8 (S-Suffix)
OP213FSZ ¹	-40°C to +85°C	8-Lead SOIC_N	R-8 (S-Suffix)
OP213FSZ-REEL ¹	-40°C to +85°C	8-Lead SOIC_N	R-8 (S-Suffix)
OP213FSZ-REEL7 ¹	-40°C to +85°C	8-Lead SOIC_N	R-8 (S-Suffix)

Model	Temperature Range	Package Description	Package Options
OP413ES	-40°C to +85°C	16-Lead Wide Body SOIC_W	RW-16 (S-Suffix)
OP413ES-REEL	-40°C to +85°C	16-Lead Wide Body SOIC_W	RW-16 (S-Suffix)
OP413ESZ ¹	-40°C to +85°C	16-Lead Wide Body SOIC_W	RW-16 (S-Suffix)
OP413ESZ-REEL ¹	-40°C to +85°C	16-Lead Wide Body SOIC_W	RW-16 (S-Suffix)
OP413FS	-40°C to +85°C	16-Lead Wide Body SOIC_W	RW-16 (S-Suffix)
OP413FS-REEL	-40°C to +85°C	16-Lead Wide Body SOIC_W	RW-16 (S-Suffix)
OP413FSZ ¹	-40°C to +85°C	16-Lead Wide Body SOIC_W	RW-16 (S-Suffix)
OP413FSZ-REEL ¹	-40°C to +85°C	16-Lead Wide Body SOIC_W	RW-16 (S-Suffix)

¹ Z = RoHS Compliant Part.

OP113/OP213/OP413

NOTES

NOTES

OP113/OP213/OP413

NOTES