

FEATURES

- Adjustable Gain and Fixed Gain Blocks of 1, 2, 5 and 10
- $\pm 0.3\%$ (Max) Gain Error from -40°C to 85°C
- 3.5ppm/ $^{\circ}\text{C}$ Gain Temperature Coefficient
- 5ppm Gain Long Term Stability
- Fully Differential Input and Output
- C_{LOAD} Stable up to 10,000pF
- Adjustable Output Common Mode Voltage
- Rail-to-Rail Output Swing
- Low Supply Current: 1mA (Max)
- High Output Current: 10mA (Min)
- Specified on a Single 2.7V to $\pm 5\text{V}$ Supply
- DC Offset Voltage $< 2.5\text{mV}$ (Max)
- Available in 8-Lead MSOP Package

APPLICATIONS

- Differential Driver/Receiver
- Differential Amplification
- Single-Ended to Differential Conversion
- Level Shifting
- Trimmed Phase Response for Multichannel Systems

DESCRIPTION

The LTC[®]1992 product family consists of five fully differential, low power amplifiers. The LTC1992 is an unconstrained fully differential amplifier. The LTC1992-1, LTC1992-2, LTC1992-5 and LTC1992-10 are fixed gain blocks (with gains of 1, 2, 5 and 10 respectively) featuring precision on-chip resistors for accurate and ultrastable gain. All of the LTC1992 parts have a separate internal common mode feedback path for outstanding output phase balancing and reduced second order harmonics. The V_{OCM} pin sets the output common mode level independent of the input common mode level. This feature makes level shifting of signals easy.

The amplifiers' differential inputs operate with signals ranging from rail-to-rail with a common mode level from the negative supply up to 1.3V from the positive supply. The differential input DC offset is typically 250 μV . The rail-to-rail outputs sink and source 10mA. The LTC1992 is stable for all capacitive loads up to 10,000pF.

The LTC1992 can be used in single supply applications with supply voltages as low as 2.7V. It can also be used with dual supplies up to $\pm 5\text{V}$. The LTC1992 is available in an 8-pin MSOP package.

 , LTC and LT are registered trademarks of Linear Technology Corporation. All other trademarks are the property of their respective owners.

TYPICAL APPLICATION

Single-Supply, Single-Ended to Differential Conversion

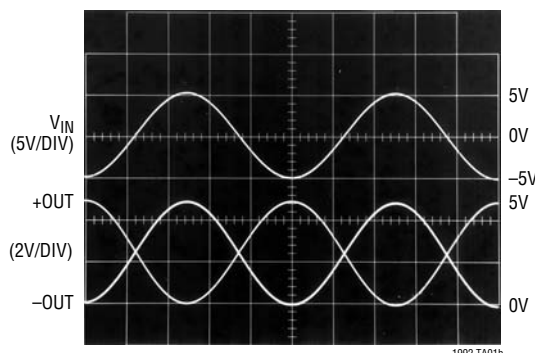
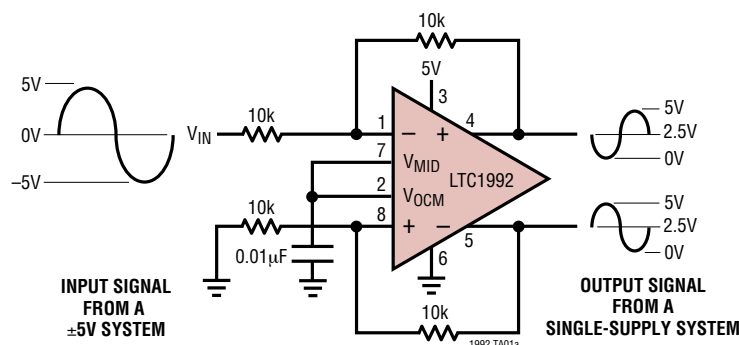

LTC1992 Family

ABSOLUTE MAXIMUM RATINGS (Note 1)

Total Supply Voltage (+V_S to -V_S) 12V
 Maximum Voltage
 on any Pin $(-V_S - 0.3V) \leq V_{PIN} \leq (+V_S + 0.3V)$
 Output Short-Circuit Duration (Note 3) Indefinite
 Operating Temperature Range (Note 5)
 LTC1992CMS8/LTC1992-XCMS8/
 LTC1992IMS8/LTC1992-XIMS8 -40°C to 85°C
 LTC1992HMS8/LTC1992-XHMS8 -40°C to 125°C

Specified Temperature Range (Note 6)
 LTC1992CMS8/LTC1992-XCMS8/
 LTC1992IMS8/LTC1992-XIMS8 -40°C to 85°C
 LTC1992HMS8/LTC1992-XHMS8 -40°C to 125°C
 Storage Temperature Range -65°C to 150°C
 Lead Temperature (Soldering, 10 sec) 300°C

PACKAGE/ORDER INFORMATION

| ORDER PART NUMBER | MS8 PART MARKING | ORDER PART NUMBER | MS8 PART MARKING |
|-------------------|------------------|-------------------|------------------|
| LTC1992CMS8 | LTYU | LTC1992-1CMS8 | LTACJ |
| LTC1992IMS8 | LTZC | LTC1992-1IMS8 | LTACM |
| LTC1992HMS8 | LTAGR | LTC1992-1HMS8 | LTAJZ |
| | | LTC1992-2CMS8 | LTYV |
| | | LTC1992-2IMS8 | LTZD |
| | | LTC1992-2HMS8 | LTAGA |
| | | LTC1992-5CMS8 | LTACK |
| | | LTC1992-5IMS8 | LTACN |
| | | LTC1992-5HMS8 | LTAJH |
| | | LTC1992-10CMS8 | LTACL |
| | | LTC1992-10IMS8 | LTACP |
| | | LTC1992-10HMS8 | LTAJJ |

Consult LTC Marketing for parts specified with wider operating temperature ranges.

ELECTRICAL CHARACTERISTICS The ● denotes specifications which apply over the full operating temperature range, otherwise specifications are at $T_A = 25^\circ\text{C}$. $+V_S = 5\text{V}$, $-V_S = 0\text{V}$, $V_{\text{INCM}} = V_{\text{OUTCM}} = V_{\text{OCM}} = 2.5\text{V}$, unless otherwise noted. V_{OCM} is the voltage on the V_{OCM} pin. V_{OUTCM} is defined as $(+V_{\text{OUT}} + -V_{\text{OUT}})/2$. V_{INCM} is defined as $(+V_{\text{IN}} + -V_{\text{IN}})/2$. V_{INDIFF} is defined as $(+V_{\text{IN}} - -V_{\text{IN}})$. V_{OUTDIFF} is defined as $(+V_{\text{OUT}} - -V_{\text{OUT}})$. Specifications applicable to all parts in the LTC1992 family.

| SYMBOL | PARAMETER | CONDITIONS | ALL C AND I GRADE | | | ALL H GRADE | | | UNITS | |
|-------------------------------------|--|---|-------------------|----------------------|----------------------|-------------|----------------------|----------------------|------------------------------|---|
| | | | MIN | TYP | MAX | MIN | TYP | MAX | | |
| V_S | Supply Voltage Range | | ● | 2.7 | 11 | | 2.7 | 11 | V | |
| I_S | Supply Current | $V_S = 2.7\text{V to }5\text{V}$ $V_S = \pm 5\text{V}$ | ● | 0.65 | 1.0 | | 0.65 | 1.0 | mA | |
| | | | ● | 0.75 | 1.2 | | 0.8 | 1.5 | mA | |
| | | | ● | 0.7 | 1.2 | | 0.7 | 1.2 | mA | |
| | | | ● | 0.8 | 1.5 | | 0.9 | 1.8 | mA | |
| V_{OSDIFF} | Differential Offset Voltage (Input Referred) (Note 7) | $V_S = 2.7\text{V}$ $V_S = 5\text{V}$ $V_S = \pm 5\text{V}$ | ● | ± 0.25 | ± 2.5 | | ± 0.25 | ± 4 | mV | |
| | | | ● | ± 0.25 | ± 2.5 | | ± 0.25 | ± 4 | mV | |
| | | | ● | ± 0.25 | ± 2.5 | | ± 0.25 | ± 4 | mV | |
| $\Delta V_{\text{OSDIFF}}/\Delta T$ | Differential Offset Voltage Drift (Input Referred) (Note 7) | $V_S = 2.7\text{V}$ $V_S = 5\text{V}$ $V_S = \pm 5\text{V}$ | ● | 10 | | | 10 | | $\mu\text{V}/^\circ\text{C}$ | |
| | | | ● | 10 | | | 10 | | $\mu\text{V}/^\circ\text{C}$ | |
| | | | ● | 10 | | | 10 | | $\mu\text{V}/^\circ\text{C}$ | |
| PSRR | Power Supply Rejection Ratio (Input Referred) (Note 7) | $V_S = 2.7\text{V to } \pm 5\text{V}$ | ● | 75 | 80 | | 72 | 80 | dB | |
| G_{CM} | Common Mode Gain ($V_{\text{OUTCM}}/V_{\text{OCM}}$) Common Mode Gain Error Output Balance ($\Delta V_{\text{OUTCM}}/\Delta V_{\text{OUTDIFF}}$) | $V_{\text{OUTDIFF}} = -2\text{V to } +2\text{V}$ | ● | 1 | | | 1 | | | |
| | | | ● | ± 0.1 | ± 0.3 | | ± 0.1 | ± 0.35 | % | |
| | | | ● | -85 | -60 | | -85 | -60 | dB | |
| V_{OSCM} | Common Mode Offset Voltage ($V_{\text{OUTCM}} - V_{\text{OCM}}$) | $V_S = 2.7\text{V}$ $V_S = 5\text{V}$ $V_S = \pm 5\text{V}$ | ● | ± 0.5 | ± 12 | | ± 0.5 | ± 15 | mV | |
| | | | ● | ± 1 | ± 15 | | ± 1 | ± 17 | mV | |
| | | | ● | ± 2 | ± 18 | | ± 2 | ± 20 | mV | |
| $\Delta V_{\text{OSCM}}/\Delta T$ | Common Mode Offset Voltage Drift | $V_S = 2.7\text{V}$ $V_S = 5\text{V}$ $V_S = \pm 5\text{V}$ | ● | 10 | | | 10 | | $\mu\text{V}/^\circ\text{C}$ | |
| | | | ● | 10 | | | 10 | | $\mu\text{V}/^\circ\text{C}$ | |
| | | | ● | 10 | | | 10 | | $\mu\text{V}/^\circ\text{C}$ | |
| V_{OUTCMR} | Output Signal Common Mode Range (Voltage Range for the V_{OCM} Pin) | | ● | $(-V_S)+0.5\text{V}$ | $(+V_S)-1.3\text{V}$ | | $(-V_S)+0.5\text{V}$ | $(+V_S)-1.3\text{V}$ | V | |
| R_{INVOCM} | Input Resistance, V_{OCM} Pin | | ● | 500 | | | 500 | | M Ω | |
| I_{BVOCM} | Input Bias Current, V_{OCM} Pin | $V_S = 2.7\text{V to } \pm 5\text{V}$ | ● | ± 2 | | | ± 2 | | pA | |
| V_{MID} | Voltage at the V_{MID} Pin | | ● | 2.44 | 2.50 | 2.56 | 2.43 | 2.50 | 2.57 | V |
| V_{OUT} | Output Voltage, High (Note 2) | $V_S = 2.7\text{V, Load} = 10\text{k}$ $V_S = 2.7\text{V, Load} = 5\text{mA}$ $V_S = 2.7\text{V, Load} = 10\text{mA}$ | ● | 2.60 | 2.69 | | 2.60 | 2.69 | | V |
| | | | ● | 2.50 | 2.61 | | 2.50 | 2.61 | | V |
| | | | ● | 2.29 | 2.52 | | 2.29 | 2.52 | | V |
| | Output Voltage, Low (Note 2) | $V_S = 2.7\text{V, Load} = 10\text{k}$ $V_S = 2.7\text{V, Load} = 5\text{mA}$ $V_S = 2.7\text{V, Load} = 10\text{mA}$ | ● | 0.02 | 0.10 | | 0.02 | 0.10 | | V |
| | | | ● | 0.10 | 0.25 | | 0.10 | 0.25 | | V |
| | | | ● | 0.20 | 0.35 | | 0.20 | 0.41 | | V |
| | Output Voltage, High (Note 2) | $V_S = 5\text{V, Load} = 10\text{k}$ $V_S = 5\text{V, Load} = 5\text{mA}$ $V_S = 5\text{V, Load} = 10\text{mA}$ | ● | 4.90 | 4.99 | | 4.90 | 4.99 | | V |
| | | | ● | 4.85 | 4.90 | | 4.80 | 4.90 | | V |
| | | | ● | 4.75 | 4.81 | | 4.70 | 4.81 | | V |
| | Output Voltage, Low (Note 2) | $V_S = 5\text{V, Load} = 10\text{k}$ $V_S = 5\text{V, Load} = 5\text{mA}$ $V_S = 5\text{V, Load} = 10\text{mA}$ | ● | 0.02 | 0.10 | | 0.02 | 0.10 | | V |
| | | | ● | 0.10 | 0.25 | | 0.10 | 0.30 | | V |
| | | | ● | 0.20 | 0.35 | | 0.20 | 0.42 | | V |
| | Output Voltage, High (Note 2) | $V_S = \pm 5\text{V, Load} = 10\text{k}$ $V_S = \pm 5\text{V, Load} = 5\text{mA}$ $V_S = \pm 5\text{V, Load} = 10\text{mA}$ | ● | 4.90 | 4.99 | | 4.85 | 4.99 | | V |
| | | | ● | 4.85 | 4.89 | | 4.80 | 4.89 | | V |
| | | | ● | 4.65 | 4.80 | | 4.60 | 4.80 | | V |
| | Output Voltage, Low (Note 2) | $V_S = \pm 5\text{V, Load} = 10\text{k}$ $V_S = \pm 5\text{V, Load} = 5\text{mA}$ $V_S = \pm 5\text{V, Load} = 10\text{mA}$ | ● | -4.99 | -4.90 | | -4.98 | -4.85 | | V |
| | | | ● | -4.90 | -4.75 | | -4.90 | -4.75 | | V |
| | | | ● | -4.80 | -4.65 | | -4.80 | -4.55 | | V |

LTC1992 Family

ELECTRICAL CHARACTERISTICS

The ● denotes specifications which apply over the full operating temperature range, otherwise specifications are at $T_A = 25^\circ\text{C}$. $+V_S = 5\text{V}$, $-V_S = 0\text{V}$, $V_{\text{INCM}} = V_{\text{OUTCM}} = V_{\text{OCM}} = 2.5\text{V}$, unless otherwise noted. V_{OCM} is the voltage on the V_{OCM} pin. V_{OUTCM} is defined as $(+V_{\text{OUT}} + -V_{\text{OUT}})/2$. V_{INCM} is defined as $(+V_{\text{IN}} + -V_{\text{IN}})/2$. V_{INDIFF} is defined as $(+V_{\text{IN}} - -V_{\text{IN}})$. V_{OUTDIFF} is defined as $(+V_{\text{OUT}} - -V_{\text{OUT}})$. Specifications applicable to all parts in the LTC1992 family.

| SYMBOL | PARAMETER | CONDITIONS | ALL C AND I GRADE | | | ALL H GRADE | | | UNITS | |
|------------------|---|---|-------------------|-----|-----|-------------|-----|-----|-------|----|
| | | | MIN | TYP | MAX | MIN | TYP | MAX | | |
| I_{SC} | Output Short-Circuit Current Sourcing (Notes 2,3) | $V_S = 2.7\text{V}$, $V_{\text{OUT}} = 1.35\text{V}$ | ● | 20 | 30 | | 20 | 30 | mA | |
| | | $V_S = 5\text{V}$, $V_{\text{OUT}} = 2.5\text{V}$ | ● | 20 | 30 | | 20 | 30 | mA | |
| | | $V_S = \pm 5\text{V}$, $V_{\text{OUT}} = 0\text{V}$ | ● | 20 | 30 | | 20 | 30 | mA | |
| | Output Short-Circuit Current Sinking (Notes 2,3) | $V_S = 2.7\text{V}$, $V_{\text{OUT}} = 1.35\text{V}$ | ● | 13 | 30 | | 13 | 30 | mA | |
| | | $V_S = 5\text{V}$, $V_{\text{OUT}} = 2.5\text{V}$ | ● | 13 | 30 | | 13 | 30 | mA | |
| | | $V_S = \pm 5\text{V}$, $V_{\text{OUT}} = 0\text{V}$ | ● | 13 | 30 | | 13 | 30 | mA | |
| A_{VOL} | Large-Signal Voltage Gain | | ● | 80 | | | 80 | | | dB |

The ● denotes specifications which apply over the full operating temperature range, otherwise specifications are at $T_A = 25^\circ\text{C}$. $+V_S = 5\text{V}$, $-V_S = 0\text{V}$, $V_{\text{INCM}} = V_{\text{OUTCM}} = V_{\text{OCM}} = 2.5\text{V}$, unless otherwise noted. V_{OCM} is the voltage on the V_{OCM} pin. V_{OUTCM} is defined as $(+V_{\text{OUT}} + -V_{\text{OUT}})/2$. V_{INCM} is defined as $(+V_{\text{IN}} + -V_{\text{IN}})/2$. V_{INDIFF} is defined as $(+V_{\text{IN}} - -V_{\text{IN}})$. V_{OUTDIFF} is defined as $(+V_{\text{OUT}} - -V_{\text{OUT}})$. Specifications applicable to the LTC1992 only.

| SYMBOL | PARAMETER | CONDITIONS | | LTC1992CMS8 LTC1992ISM8 | | | LTC1992HMS8 | | | UNITS |
|--------------------|--|---|---|----------------------------|------------------------|-----|------------------------|------------------------|-----|------------------------------|
| | | | | MIN | TYP | MAX | MIN | TYP | MAX | |
| I_{B} | Input Bias Current | $V_S = 2.7\text{V}$ to $\pm 5\text{V}$ | ● | | 2 | 250 | | 2 | 400 | pA |
| I_{OS} | Input Offset Current | $V_S = 2.7\text{V}$ to $\pm 5\text{V}$ | ● | | 0.1 | 100 | | 0.1 | 150 | pA |
| R_{IN} | Input Resistance | | ● | | 500 | | | 500 | | $\text{M}\Omega$ |
| C_{IN} | Input Capacitance | | ● | | 3 | | | 3 | | pF |
| e_{n} | Input Referred Noise Voltage Density | $f = 1\text{kHz}$ | | | 35 | | | 35 | | $\text{nV}/\sqrt{\text{Hz}}$ |
| i_{n} | Input Noise Current Density | $f = 1\text{kHz}$ | | | 1 | | | 1 | | $\text{fA}/\sqrt{\text{Hz}}$ |
| V_{INCMR} | Input Signal Common Mode Range | | ● | $(-V_S) - 0.1\text{V}$ | $(+V_S) - 1.3\text{V}$ | | $(-V_S) - 0.1\text{V}$ | $(+V_S) - 1.3\text{V}$ | | V |
| CMRR | Common Mode Rejection Ratio (Input Referred) | $V_{\text{INCM}} = -0.1\text{V}$ to 3.7V | ● | 69 | 90 | | 69 | 90 | | dB |
| SR | Slew Rate (Note 4) | | ● | 0.5 | 1.5 | | 0.5 | 1.5 | | $\text{V}/\mu\text{s}$ |
| GBW | Gain-Bandwidth Product ($f_{\text{TEST}} = 100\text{kHz}$) | $T_A = 25^\circ\text{C}$ | | 3.0 | 3.2 | 3.5 | 3.0 | 3.2 | 3.5 | MHz |
| | | LTC1992CMS8 | ● | 2.5 | 3.0 | 4.0 | | | | MHz |
| | | LTC1992IMS8/ LTC1992HMS8 | ● | 1.9 | | 4.0 | 1.9 | | 4.0 | MHz |

ELECTRICAL CHARACTERISTICS The ● denotes specifications which apply over the full operating temperature range, otherwise specifications are at $T_A = 25^\circ\text{C}$. $+V_S = 5\text{V}$, $-V_S = 0\text{V}$, $V_{\text{INCM}} = V_{\text{OUTCM}} = V_{\text{OCM}} = 2.5\text{V}$, unless otherwise noted. V_{OCM} is the voltage on the V_{OCM} pin. V_{OUTCM} is defined as $(+V_{\text{OUT}} + -V_{\text{OUT}})/2$. V_{INCM} is defined as $(+V_{\text{IN}} + -V_{\text{IN}})/2$. V_{INDIFF} is defined as $(+V_{\text{IN}} - -V_{\text{IN}})$. V_{OUTDIFF} is defined as $(+V_{\text{OUT}} - -V_{\text{OUT}})$. Typical values are at $T_A = 25^\circ\text{C}$. Specifications apply to the LTC1992-1 only.

| SYMBOL | PARAMETER | CONDITIONS | LTC1992-1CMS8 LTC1992-1IMS8 | | | LTC1992-1HMS8 | | | UNITS | |
|--------------------|---|--|--------------------------------|---------------|-----------|---------------|---------------|-----|------------------------|------------------|
| | | | MIN | TYP | MAX | MIN | TYP | MAX | | |
| G_{DIFF} | Differential Gain | | | 1 | | | 1 | | V/V | |
| | Differential Gain Error | | ● | ± 0.1 | ± 0.3 | ± 0.1 | ± 0.35 | | % | |
| | Differential Gain Nonlinearity | | ● | 50 | | 50 | | | ppm | |
| | Differential Gain Temperature Coefficient | | ● | 3.5 | | 3.5 | | | ppm/ $^\circ\text{C}$ | |
| e_n | Input Referred Noise Voltage Density (Note 7) | $f = 1\text{kHz}$ | | 45 | | 45 | | | nV/ $\sqrt{\text{Hz}}$ | |
| R_{IN} | Input Resistance, Single-Ended +IN, -IN Pins | | ● | 22.5 | 30 | 37.5 | 22 | 30 | 38 | k Ω |
| V_{INCMR} | Input Signal Common Mode Range | $V_S = 5\text{V}$ | | -0.1V to 4.9V | | | -0.1V to 4.9V | | | V |
| CMRR | Common Mode Rejection Ratio (Amplifier Input Referred) (Note 7) | $V_{\text{INCM}} = -0.1\text{V to } 3.7\text{V}$ | ● | 55 | 60 | | 55 | 60 | | dB |
| SR | Slew Rate (Note 4) | | ● | 0.5 | 1.5 | | 0.5 | 1.5 | | V/ μs |
| GBW | Gain-Bandwidth Product | $f_{\text{TEST}} = 180\text{kHz}$ | | 3 | | | 3 | | | MHz |

The ● denotes specifications which apply over the full operating temperature range, otherwise specifications are at $T_A = 25^\circ\text{C}$. $+V_S = 5\text{V}$, $-V_S = 0\text{V}$, $V_{\text{INCM}} = V_{\text{OUTCM}} = V_{\text{OCM}} = 2.5\text{V}$, unless otherwise noted. V_{OCM} is the voltage on the V_{OCM} pin. V_{OUTCM} is defined as $(+V_{\text{OUT}} + -V_{\text{OUT}})/2$. V_{INCM} is defined as $(+V_{\text{IN}} + -V_{\text{IN}})/2$. V_{INDIFF} is defined as $(+V_{\text{IN}} - -V_{\text{IN}})$. V_{OUTDIFF} is defined as $(+V_{\text{OUT}} - -V_{\text{OUT}})$. Typical values are at $T_A = 25^\circ\text{C}$. Specifications apply to the LTC1992-2 only.

| SYMBOL | PARAMETER | CONDITIONS | LTC1992-2CMS8 LTC1992-2IMS8 | | | LTC1992-2HMS8 | | | UNITS | |
|--------------------|---|--|--------------------------------|---------------|-----------|---------------|---------------|-----|------------------------|------------------|
| | | | MIN | TYP | MAX | MIN | TYP | MAX | | |
| G_{DIFF} | Differential Gain | | | 2 | | | 2 | | V/V | |
| | Differential Gain Error | | ● | ± 0.1 | ± 0.3 | ± 0.1 | ± 0.35 | | % | |
| | Differential Gain Nonlinearity | | ● | 50 | | 50 | | | ppm | |
| | Differential Gain Temperature Coefficient | | ● | 3.5 | | 3.5 | | | ppm/ $^\circ\text{C}$ | |
| e_n | Input Referred Noise Voltage Density (Note 7) | $f = 1\text{kHz}$ | | 45 | | 45 | | | nV/ $\sqrt{\text{Hz}}$ | |
| R_{IN} | Input Resistance, Single-Ended +IN, -IN Pins | | ● | 22.5 | 30 | 37.5 | 22 | 30 | 38 | k Ω |
| V_{INCMR} | Input Signal Common Mode Range | $V_S = 5\text{V}$ | | -0.1V to 4.9V | | | -0.1V to 4.9V | | | V |
| CMRR | Common Mode Rejection Ratio (Amplifier Input Referred) (Note 7) | $V_{\text{INCM}} = -0.1\text{V to } 3.7\text{V}$ | ● | 55 | 60 | | 55 | 60 | | dB |
| SR | Slew Rate (Note 4) | | ● | 0.7 | 2 | | 0.7 | 2 | | V/ μs |
| GBW | Gain-Bandwidth Product | $f_{\text{TEST}} = 180\text{kHz}$ | | 4 | | | 4 | | | MHz |

LTC1992 Family

ELECTRICAL CHARACTERISTICS The ● denotes specifications which apply over the full operating temperature range, otherwise specifications are at $T_A = 25^\circ\text{C}$. $+V_S = 5\text{V}$, $-V_S = 0\text{V}$, $V_{INCM} = V_{OUTCM} = V_{OCM} = 2.5\text{V}$, unless otherwise noted. V_{OCM} is the voltage on the V_{OCM} pin. V_{OUTCM} is defined as $(+V_{OUT} + -V_{OUT})/2$. V_{INCM} is defined as $(+V_{IN} + -V_{IN})/2$. V_{INDIFF} is defined as $(+V_{IN} - -V_{IN})$. $V_{OUTDIFF}$ is defined as $(+V_{OUT} - -V_{OUT})$. Typical values are at $T_A = 25^\circ\text{C}$. Specifications apply to the LTC1992-5 only.

| SYMBOL | PARAMETER | CONDITIONS | LTC1992-5CMS8 LTC1992-5IMS8 | | | LTC1992-5HMS8 | | | UNITS | |
|-------------|---|---|--------------------------------|---------------|------|---------------|---------------|-----|--------|------|
| | | | MIN | TYP | MAX | MIN | TYP | MAX | | |
| G_{DIFF} | Differential Gain | | | 5 | | | 5 | | V/V | |
| | Differential Gain Error | | ● | ±0.1 | ±0.3 | ±0.1 | ±0.35 | | % | |
| | Differential Gain Nonlinearity | | ● | 50 | | 50 | | | ppm | |
| | Differential Gain Temperature Coefficient | | ● | 3.5 | | 3.5 | | | ppm/°C | |
| e_n | Input Referred Noise Voltage Density (Note 7) | $f = 1\text{kHz}$ | | 45 | | | 45 | | nV/√Hz | |
| R_{IN} | Input Resistance, Single-Ended +IN, -IN Pins | | ● | 22.5 | 30 | 37.5 | 22 | 30 | 38 | kΩ |
| V_{INCMR} | Input Signal Common Mode Range | $V_S = 5\text{V}$ | | -0.1V to 3.9V | | | -0.1V to 3.9V | | | V |
| CMRR | Common Mode Rejection Ratio (Amplifier Input Referred) (Note 7) | $V_{INCM} = -0.1\text{V to } 3.7\text{V}$ | ● | 55 | 60 | | 55 | 60 | | dB |
| SR | Slew Rate (Note 4) | | ● | 0.7 | 2 | | 0.7 | 2 | | V/μs |
| GBW | Gain-Bandwidth Product | $f_{TEST} = 180\text{kHz}$ | | 4 | | | 4 | | | MHz |

The ● denotes specifications which apply over the full operating temperature range, otherwise specifications are at $T_A = 25^\circ\text{C}$. $+V_S = 5\text{V}$, $-V_S = 0\text{V}$, $V_{INCM} = V_{OUTCM} = V_{OCM} = 2.5\text{V}$, unless otherwise noted. V_{OCM} is the voltage on the V_{OCM} pin. V_{OUTCM} is defined as $(+V_{OUT} + -V_{OUT})/2$. V_{INCM} is defined as $(+V_{IN} + -V_{IN})/2$. V_{INDIFF} is defined as $(+V_{IN} - -V_{IN})$. $V_{OUTDIFF}$ is defined as $(+V_{OUT} - -V_{OUT})$. Typical values are at $T_A = 25^\circ\text{C}$. Specifications apply to the LTC1992-10 only.

| SYMBOL | PARAMETER | CONDITIONS | LTC1992-10CMS8 LTC1992-10IMS8 | | | LTC1992-10HMS8 | | | UNITS | |
|-------------|---|---|----------------------------------|---------------|------|----------------|---------------|-----|--------|------|
| | | | MIN | TYP | MAX | MIN | TYP | MAX | | |
| G_{DIFF} | Differential Gain | | | 10 | | | 10 | | V/V | |
| | Differential Gain Error | | ● | ±0.1 | ±0.3 | ±0.1 | ±0.35 | | % | |
| | Differential Gain Nonlinearity | | ● | 50 | | 50 | | | ppm | |
| | Differential Gain Temperature Coefficient | | ● | 3.5 | | 3.5 | | | ppm/°C | |
| e_n | Input Referred Noise Voltage Density (Note 7) | $f = 1\text{kHz}$ | | 45 | | | 45 | | nV/√Hz | |
| R_{IN} | Input Resistance, Single-Ended +IN, -IN Pins | | ● | 11.3 | 15 | 18.8 | 11 | 15 | 19 | kΩ |
| V_{INCMR} | Input Signal Common Mode Range | $V_S = 5\text{V}$ | | -0.1V to 3.8V | | | -0.1V to 3.8V | | | V |
| CMRR | Common Mode Rejection Ratio (Amplifier Input Referred) (Note 7) | $V_{INCM} = -0.1\text{V to } 3.7\text{V}$ | ● | 55 | 60 | | 55 | 60 | | dB |
| SR | Slew Rate (Note 4) | | ● | 0.7 | 2 | | 0.7 | 2 | | V/μs |
| GBW | Gain-Bandwidth Product | $f_{TEST} = 180\text{kHz}$ | | 4 | | | 4 | | | MHz |

Note 1: Absolute Maximum Ratings are those values beyond which the life of a device may be impaired.

Note 2: Output load is connected to the midpoint of the $+V_S$ and $-V_S$ potentials. Measurement is taken single-ended, one output loaded at a time.

Note 3: A heat sink may be required to keep the junction temperature below the absolute maximum when the output is shorted indefinitely.

Note 4: Differential output slew rate. Slew rate is measured single ended and doubled to get the listed numbers.

Note 5: The LTC1992C/LTC1992-XC/LTC1992I/LTC1992-XI are guaranteed functional over an operating temperature of -40°C to 85°C . The LTC1992H/LTC1992-XH are guaranteed functional over the extended operating temperature of -40°C to 125°C .

Note 6: The LTC1992C/LTC1992-XC are guaranteed to meet the specified performance limits over the 0°C to 70°C temperature range and are designed, characterized and expected to meet the specified performance limits over the -40°C to 85°C temperature range but are not tested or QA sampled at these temperatures. The LTC1992I/LTC1992-XI are guaranteed to meet the specified performance limits over the -40°C to 85°C temperature range. The LTC1992H/LTC1992-XH are guaranteed to meet the specified performance limits over the -40°C to 125°C temperature range.

Note 7: Differential offset voltage, differential offset voltage drift, CMRR, noise voltage density and PSRR are referred to the internal amplifier's input to allow for direct comparison of gain blocks with discrete amplifiers.

TYPICAL PERFORMANCE CHARACTERISTICS Applicable to all parts in the LTC1992 family.

Supply Current vs Supply Voltage

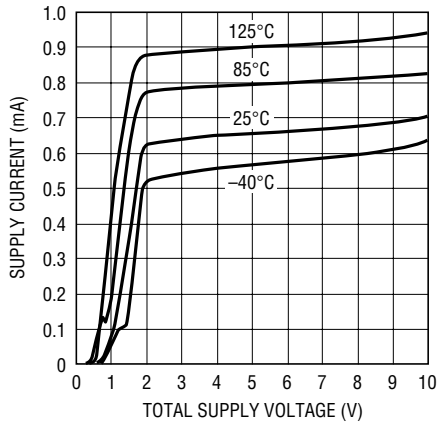

1992 G01

Differential Input Offset Voltage vs Temperature (Note 7)

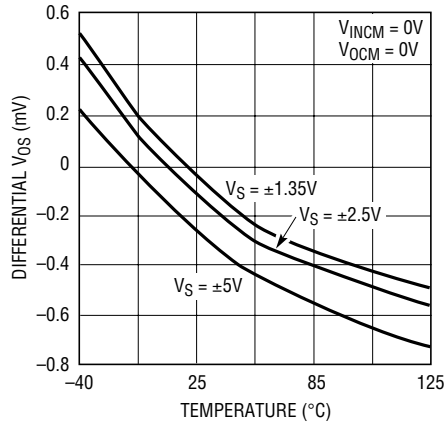

1992 G02

Common Mode Offset Voltage vs Temperature

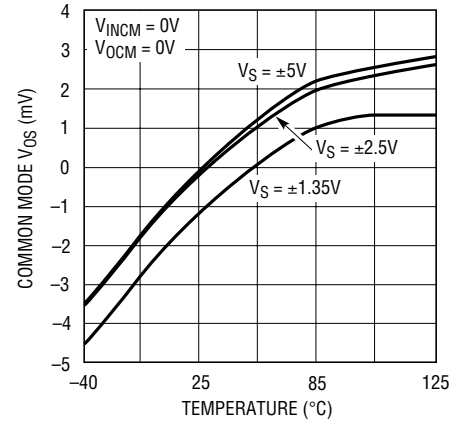

1992 G03

Common Mode Offset Voltage vs V_OCM Voltage

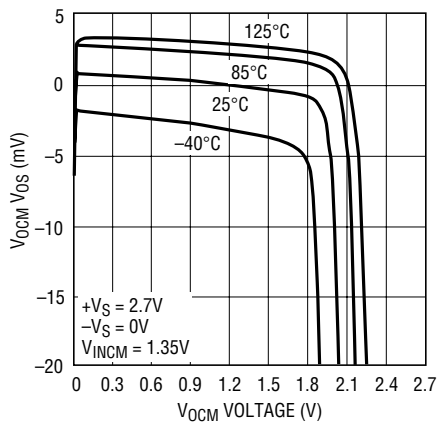

1992 G04

Common Mode Offset Voltage vs V_OCM Voltage

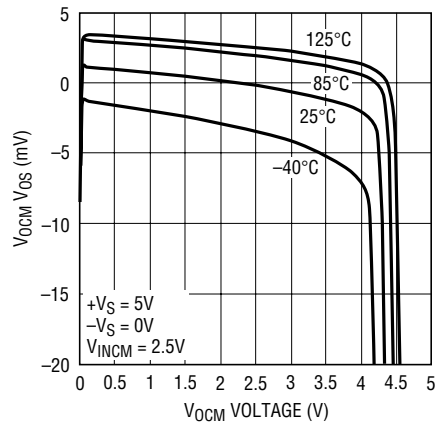

1992 G05

Common Mode Offset Voltage vs V_OCM Voltage

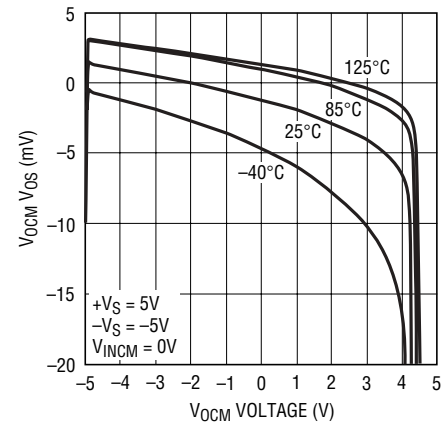

1992 G06

Output Voltage Swing vs Output Load, V_S = 2.7V

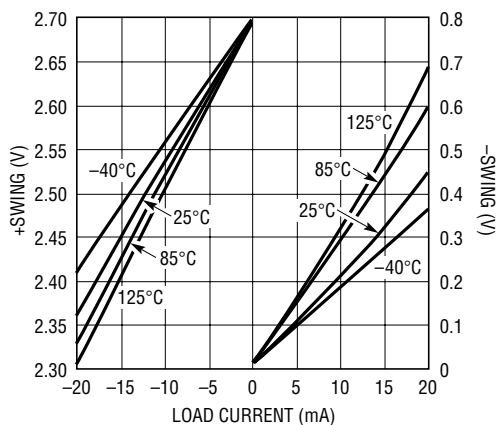

1992 G07

Output Voltage Swing vs Output Load, V_S = 5V

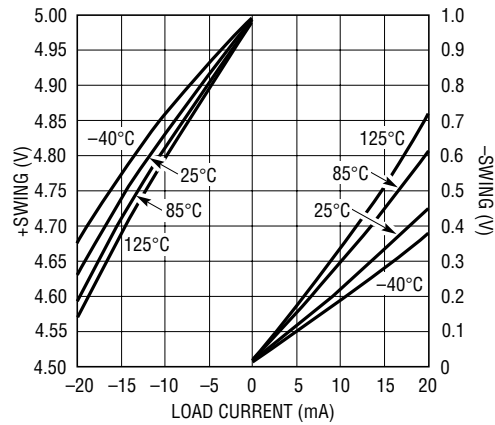

1992 G08

TYPICAL PERFORMANCE CHARACTERISTICS Applicable to all parts in the LTC1992 family.

Output Voltage Swing vs Output Load, $V_S = \pm 5V$

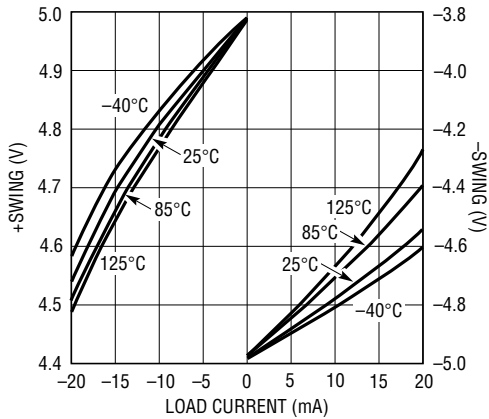

1992 G09

V_{OCM} Input Bias Current vs V_{OCM} Voltage

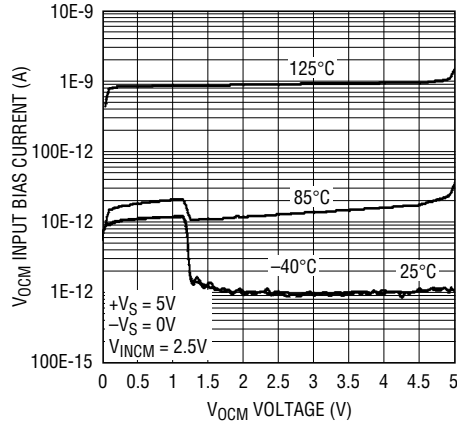

1992 G10

Differential Input Offset Voltage vs Time (Normalized to $t = 0$)

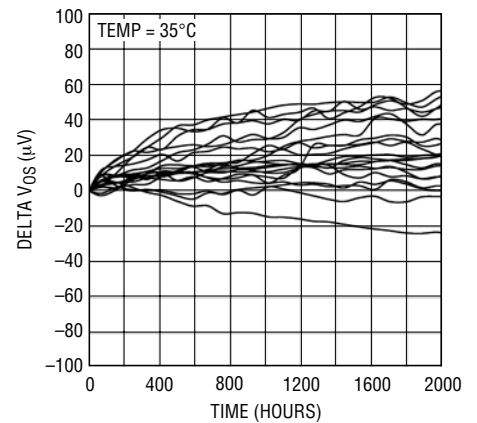

1992 G11

Differential Gain vs Time (Normalized to $t = 0$)

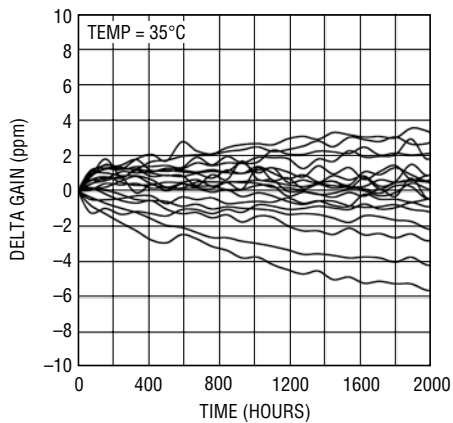

1992 G12

Input Common Mode Overdrive Recovery (Expanded View)

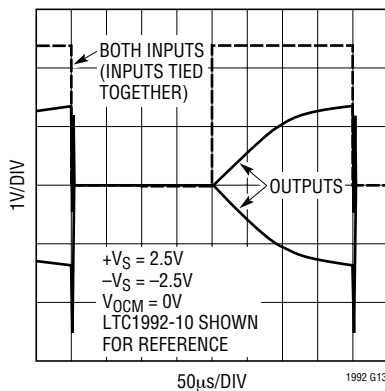

1992 G13

Input Common Mode Overdrive Recovery (Detailed View)

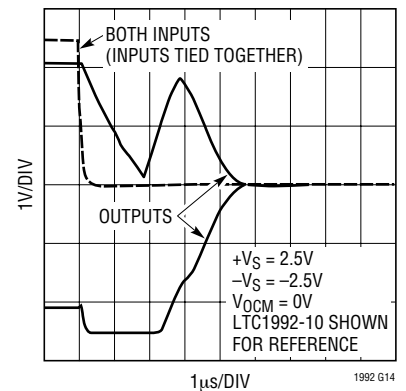

1992 G14

Output Overdrive Recovery (Expanded View)

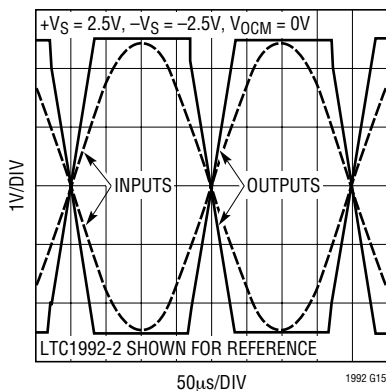

1992 G15

Output Overdrive Recovery (Detailed View)

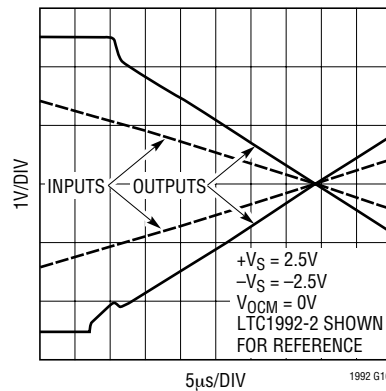

1992 G16

TYPICAL PERFORMANCE CHARACTERISTICS Applicable to the LTC1992 only.

Differential Input Differential Gain vs Frequency, $V_S = \pm 2.5V$

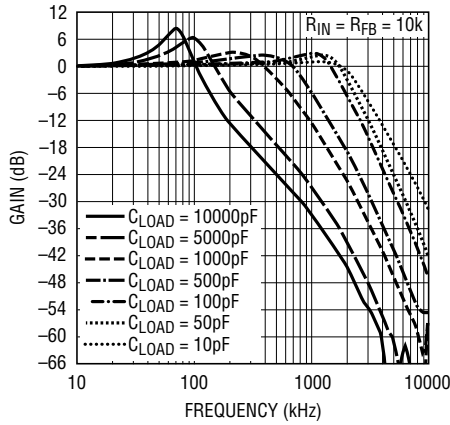

1992 G17

Single-Ended Input Differential Gain vs Frequency, $V_S = \pm 2.5V$

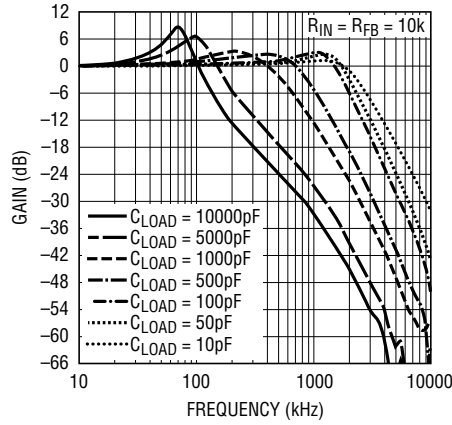

1992 G18

Differential Phase Response vs Frequency

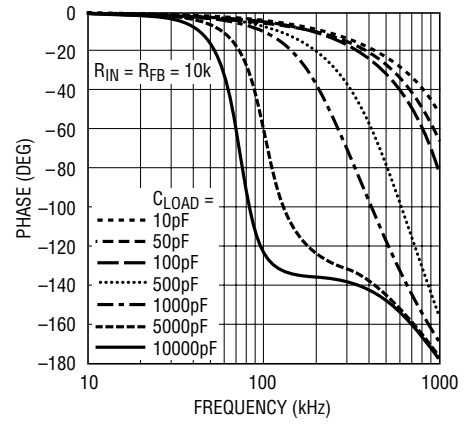

1992 G37

Differential Input Offset Voltage vs Input Common Mode Voltage

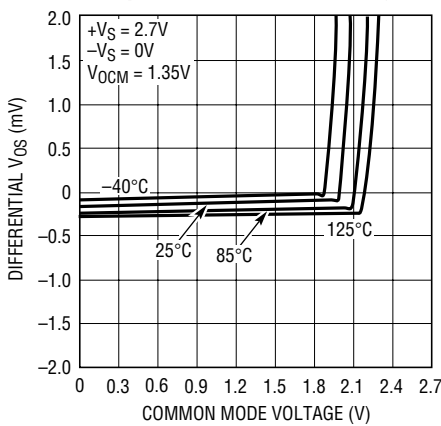

1992 G20

Differential Input Offset Voltage vs Input Common Mode Voltage

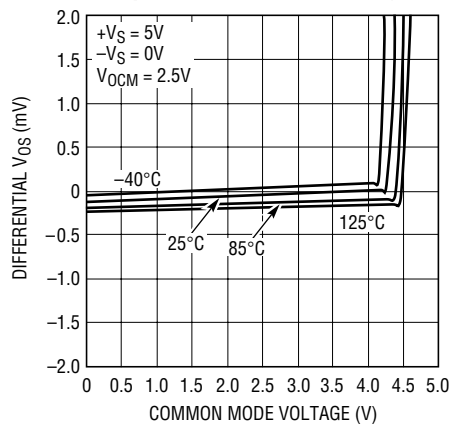

1992 G21

Differential Input Offset Voltage vs Input Common Mode Voltage

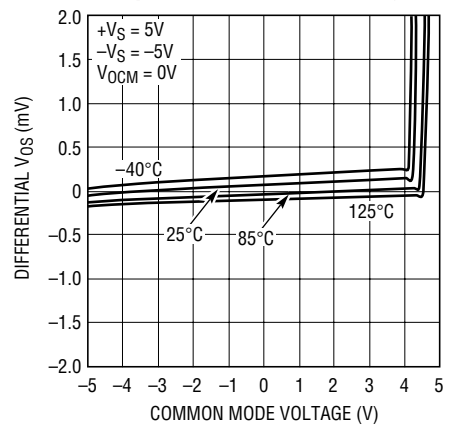

1992 G22

Common Mode Rejection Ratio vs Frequency (Note 7)

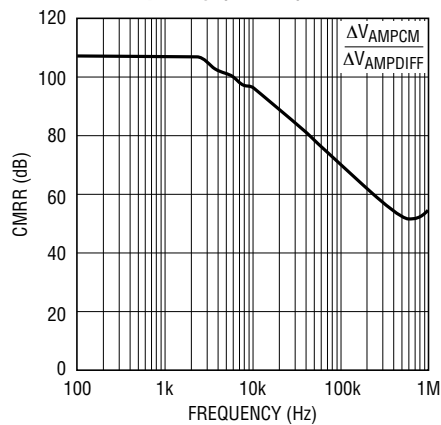

1992 G23

Power Supply Rejection Ratio vs Frequency (Note 7)

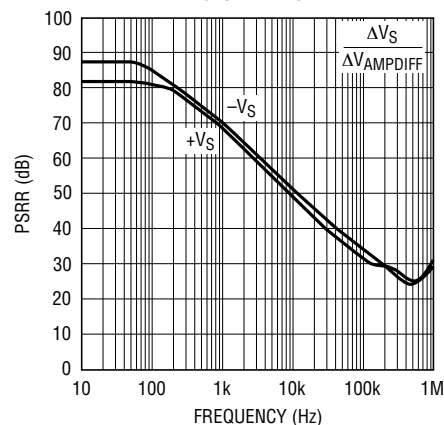

1992 G24

Output Balance vs Frequency

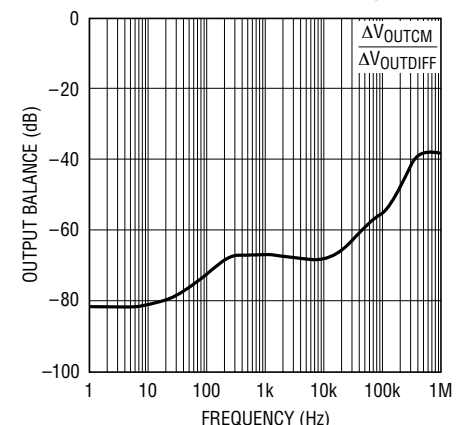

1992 G25

TYPICAL PERFORMANCE CHARACTERISTICS Applicable to the LTC1992 only.

Differential Input Large-Signal Step Response

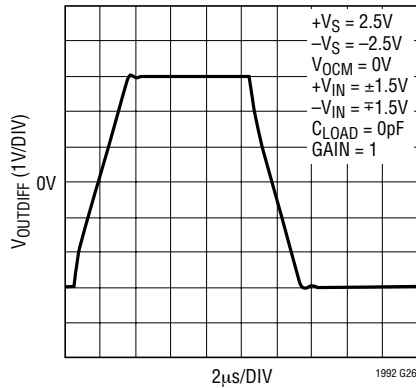

Differential Input Large-Signal Step Response

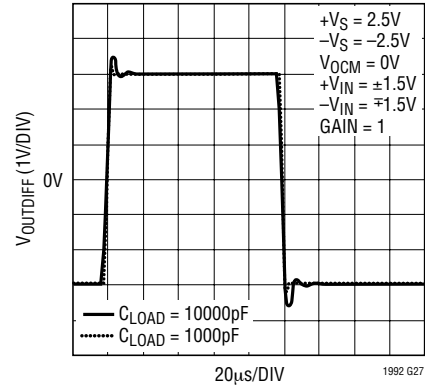

Single-Ended Input Large-Signal Step Response

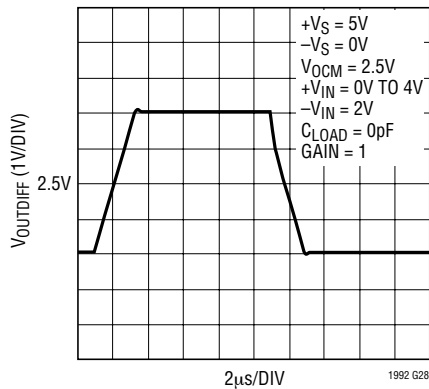

Single-Ended Input Large-Signal Step Response

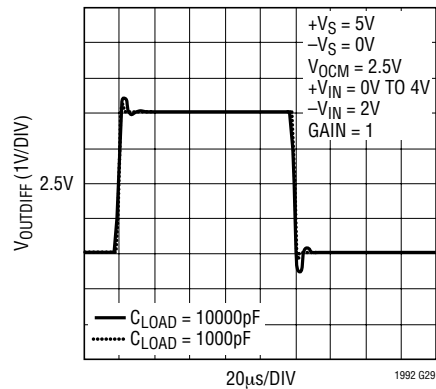

Differential Input Small-Signal Step Response

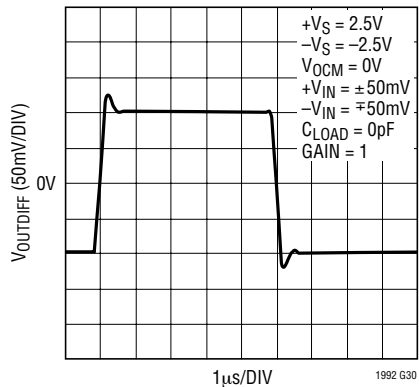

Differential Input Small-Signal Step Response

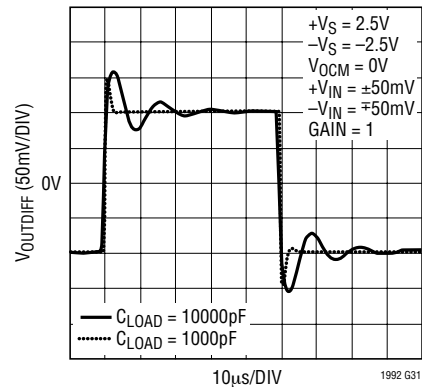

TYPICAL PERFORMANCE CHARACTERISTICS Applicable to the LTC1992 only.

Single-Ended Input Small-Signal Step Response

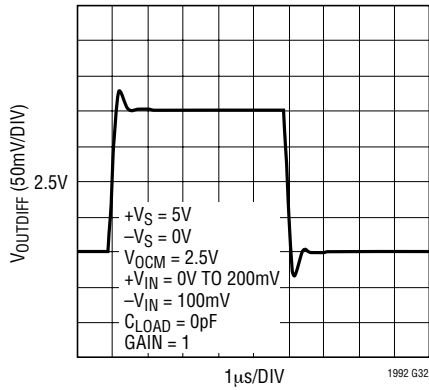

Single-Ended Input Small-Signal Step Response

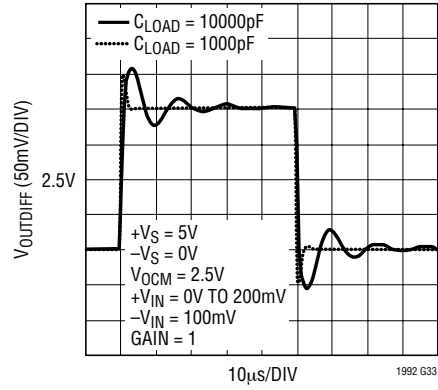

THD + Noise vs Frequency

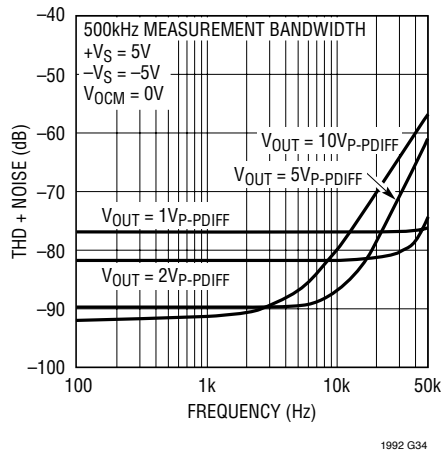

THD + Noise vs Amplitude

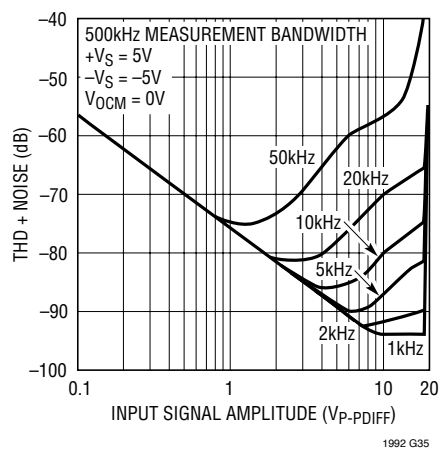

Differential Noise Voltage Density vs Frequency

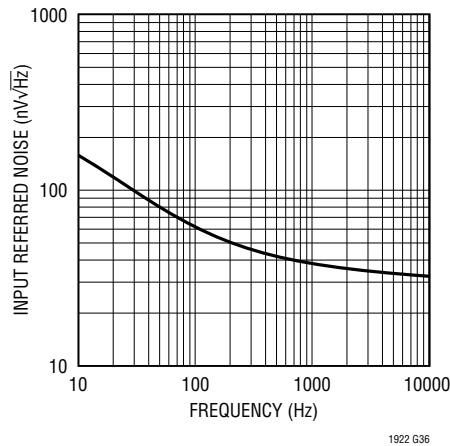

V_{OCM} Gain vs Frequency, $V_S = \pm 2.5V$

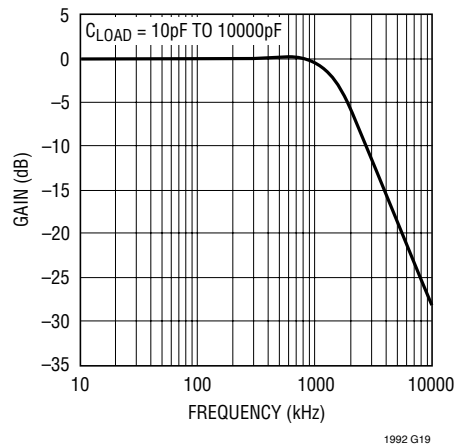

TYPICAL PERFORMANCE CHARACTERISTICS Applicable to the LTC1992-1 only.

Differential Input Differential Gain vs Frequency, $V_S = \pm 2.5V$

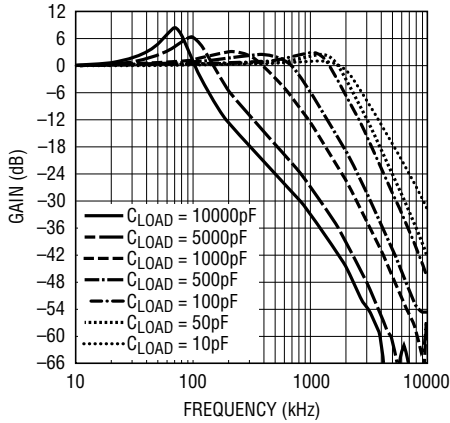

1992 G38

Single-Ended Input Differential Gain vs Frequency, $V_S = \pm 2.5V$

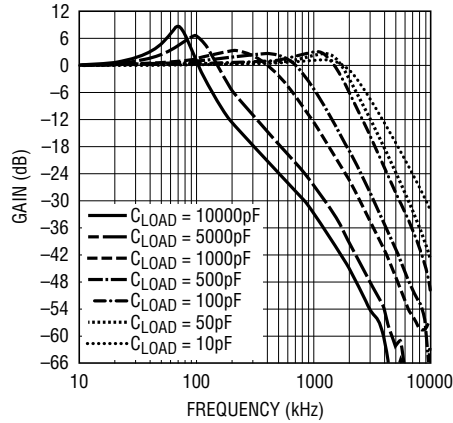

1992 G39

Differential Phase Response vs Frequency

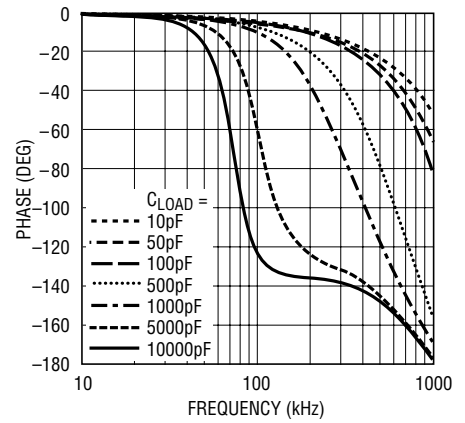

1992 G40

Differential Gain Error vs Temperature

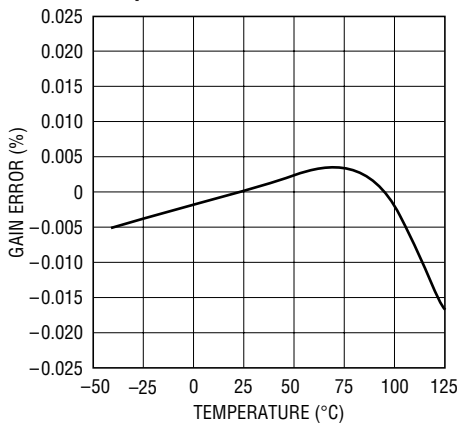

1992 G41

VOCM Gain vs Frequency

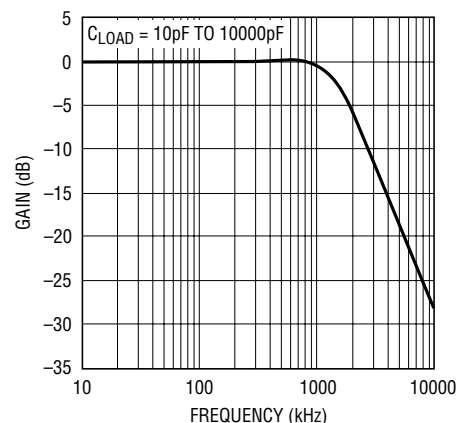

1992 G42

Differential Input Offset Voltage vs Input Common Mode Voltage

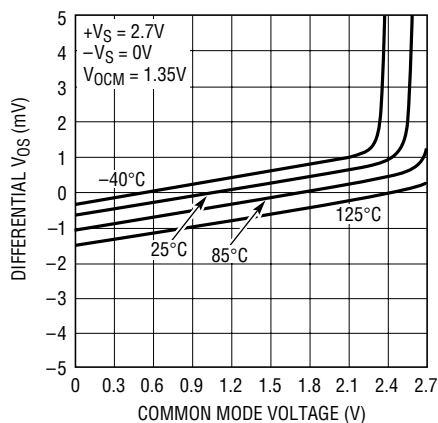

1992 G43

Differential Input Offset Voltage vs Input Common Mode Voltage

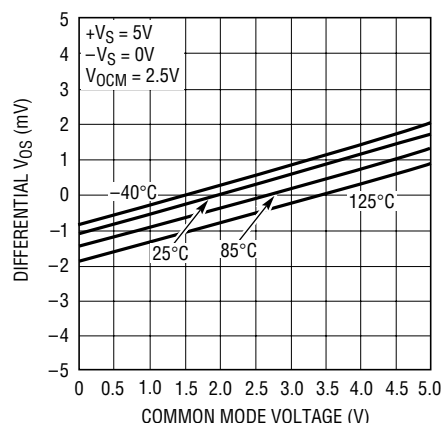

1992 G44

Differential Input Offset Voltage vs Input Common Mode Voltage

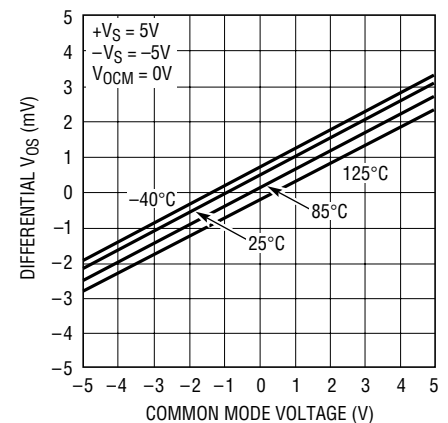

1992 G45

TYPICAL PERFORMANCE CHARACTERISTICS Applicable to the LTC1992-1 only.

Differential Input Large-Signal Step Response

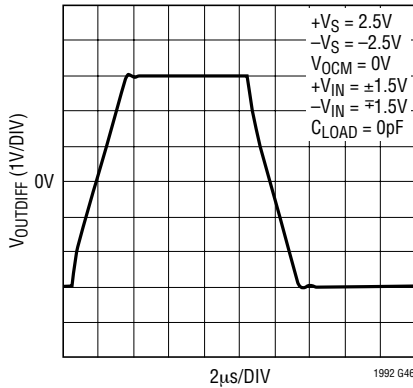

Differential Input Large-Signal Step Response

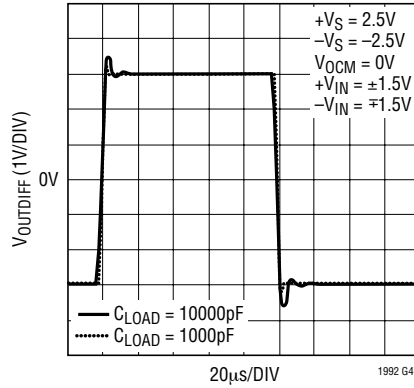

Common Mode Rejection Ratio vs Frequency

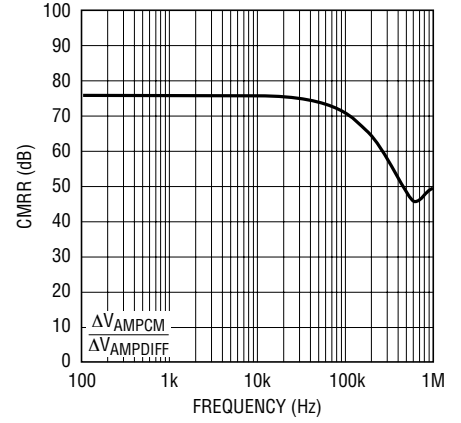

Single-Ended Input Large-Signal Step Response

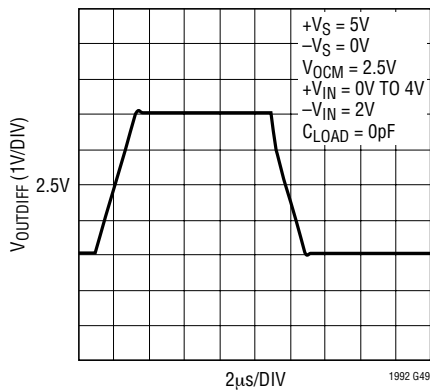

Single-Ended Input Large-Signal Step Response

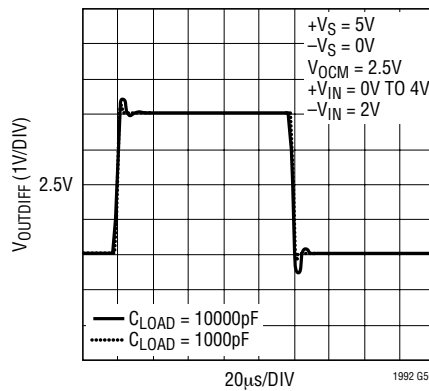

Power Supply Rejection Ratio vs Frequency

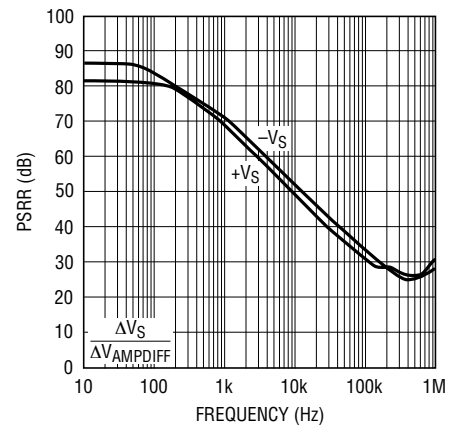

Differential Input Small-Signal Step Response

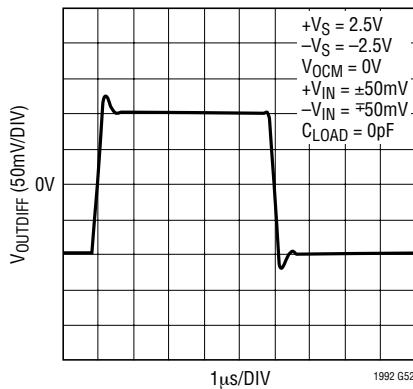

Differential Input Small-Signal Step Response

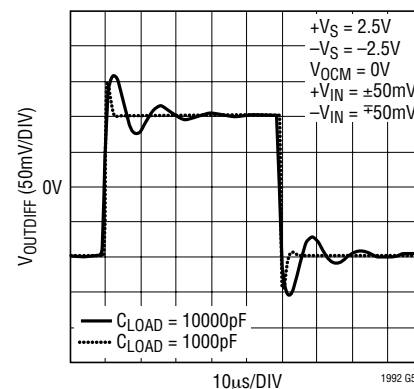

Output Balance vs Frequency

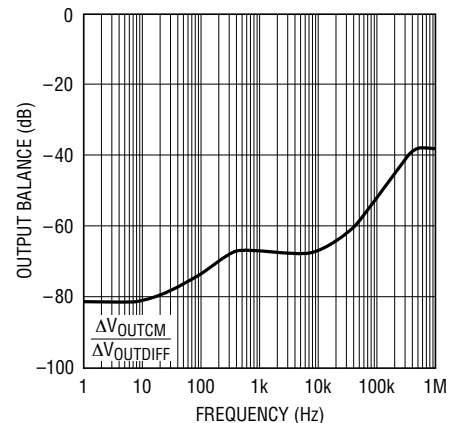

TYPICAL PERFORMANCE CHARACTERISTICS Applicable to the LTC1992-1 only.

Single-Ended Input Small-Signal Step Response

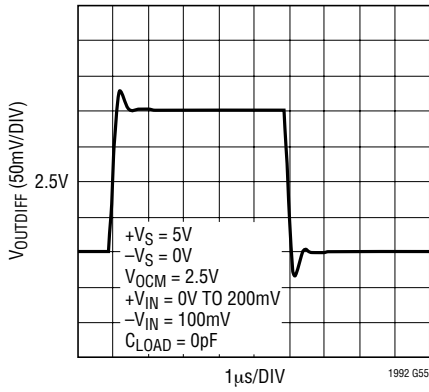

Single-Ended Input Small-Signal Step Response

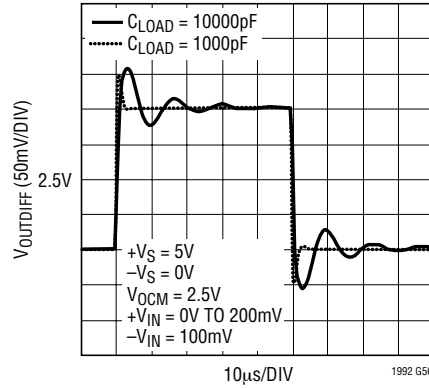

Differential Noise Voltage Density vs Frequency

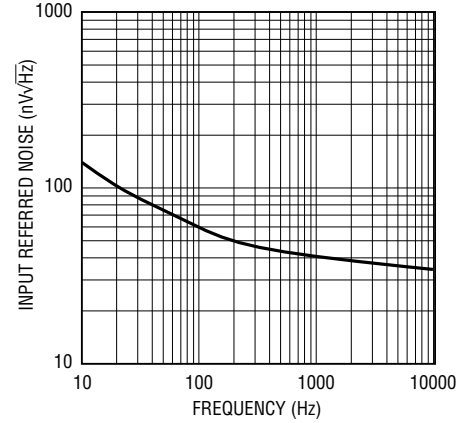

THD + Noise vs Frequency

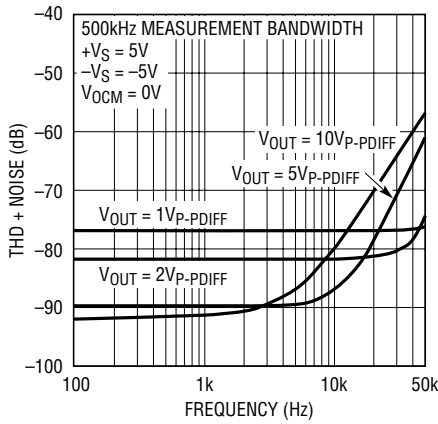

THD + Noise vs Amplitude

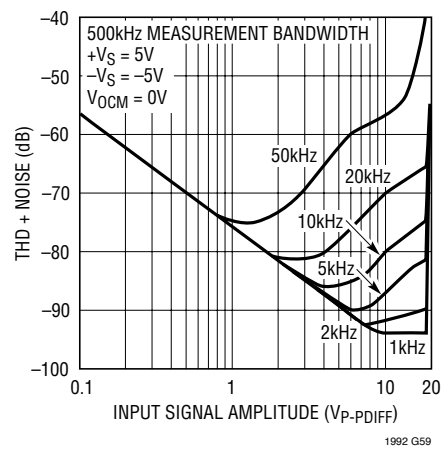

TYPICAL PERFORMANCE CHARACTERISTICS Applicable to the LTC1992-2 only.

Differential Input Differential Gain vs Frequency, $V_S = \pm 2.5V$

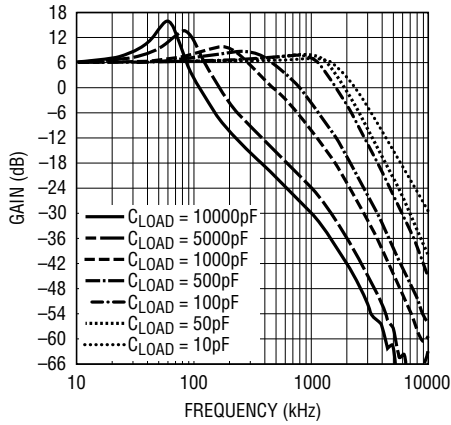

1992 G60

Single-Ended Input Differential Gain vs Frequency, $V_S = \pm 2.5V$

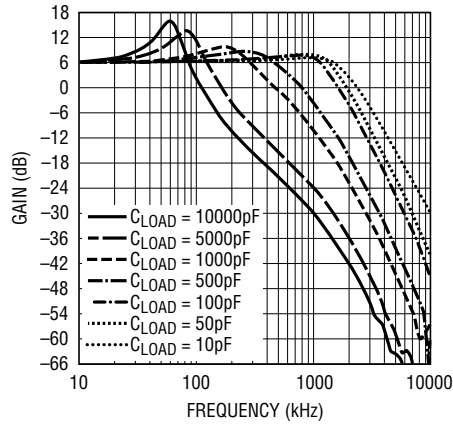

1992 G61

Differential Phase Response vs Frequency

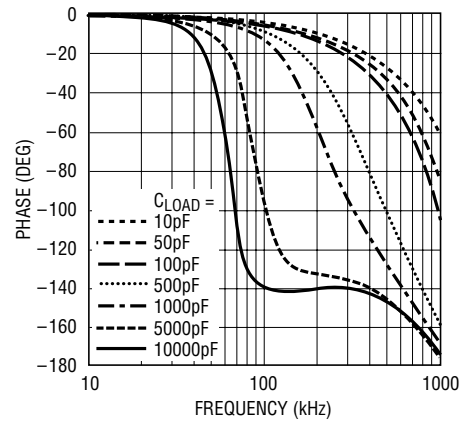

1992 G62

Differential Gain Error vs Temperature

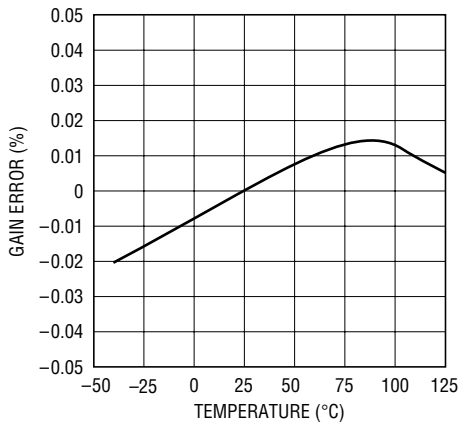

1992 G63

V_{OCM} Gain vs Frequency, $V_S = \pm 2.5V$

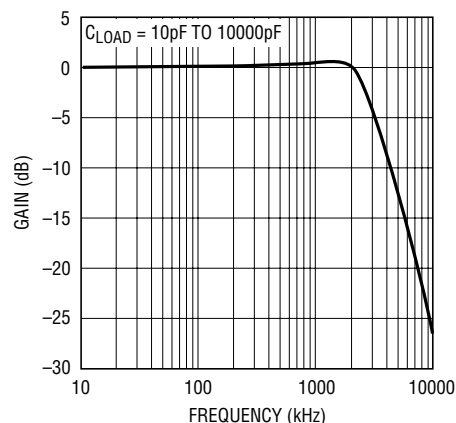

1992 G64

Differential Input Offset Voltage vs Input Common Mode Voltage (Note 7)

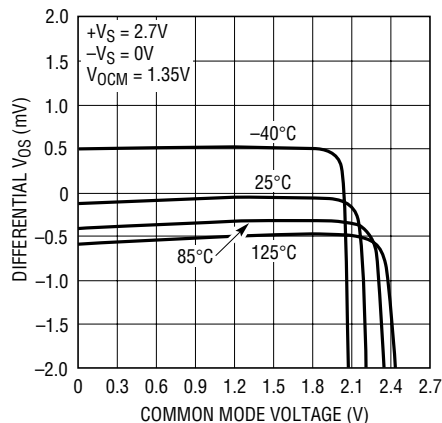

1992 G65

Differential Input Offset Voltage vs Input Common Mode Voltage (Note 7)

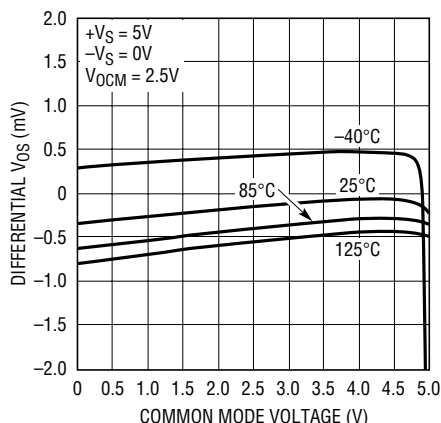

1992 G66

Differential Input Offset Voltage vs Input Common Mode Voltage (Note 7)

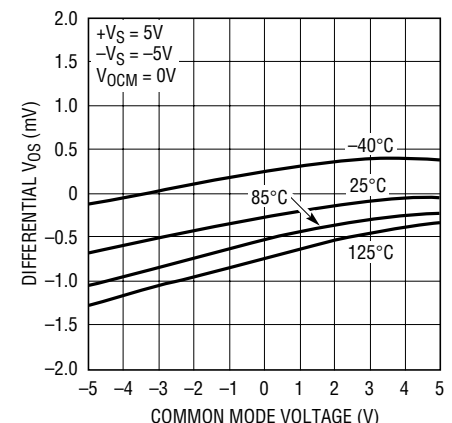

1992 G67

TYPICAL PERFORMANCE CHARACTERISTICS Applicable to the LTC1992-2 only.

Differential Input Large-Signal Step Response

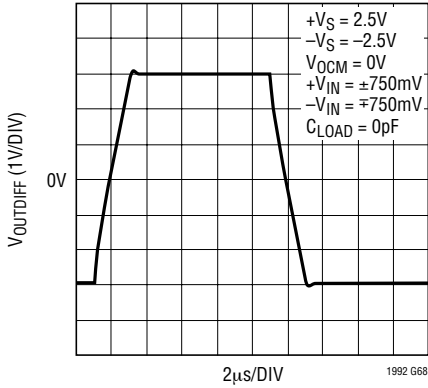

Differential Input Large-Signal Step Response

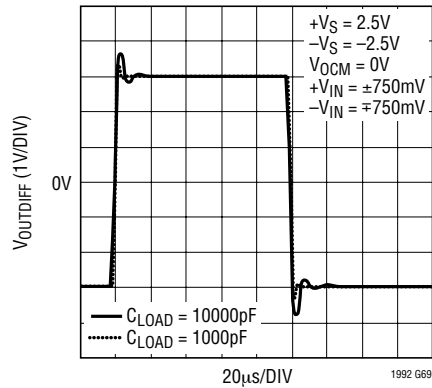

Common Mode Rejection Ratio vs Frequency (Note 7)

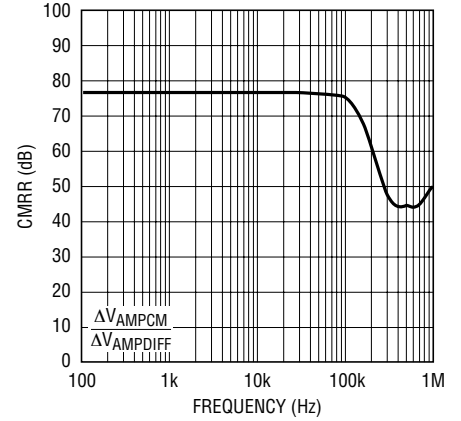

Single-Ended Input Large-Signal Step Response

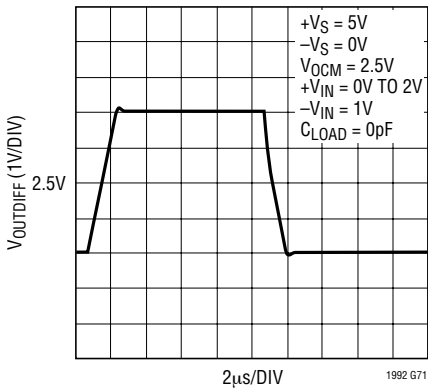

Single-Ended Input Large-Signal Step Response

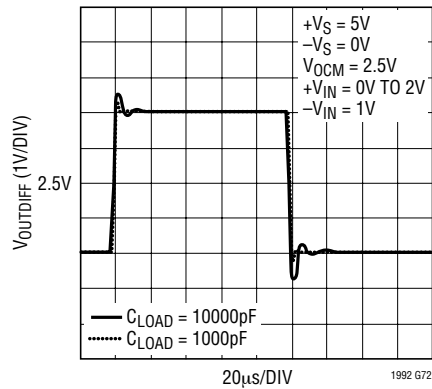

Power Supply Rejection Ratio vs Frequency (Note 7)

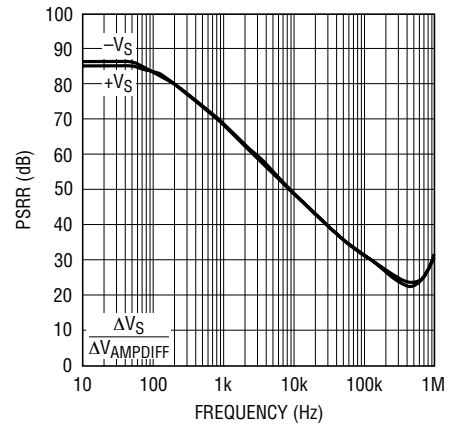

Differential Input Small-Signal Step Response

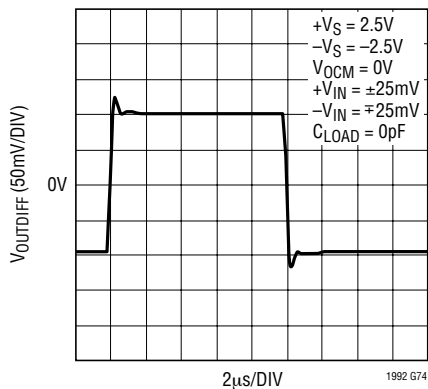

Differential Input Small-Signal Step Response

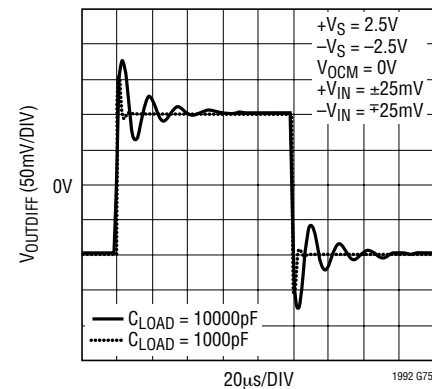

Output Balance vs Frequency

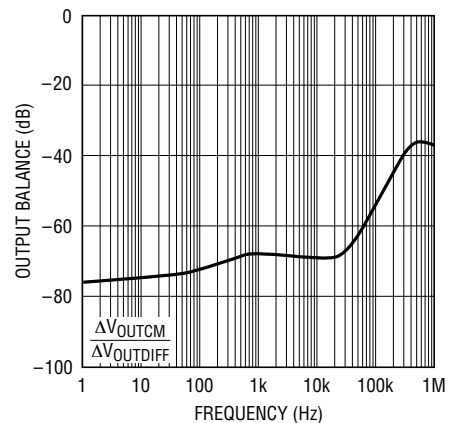

TYPICAL PERFORMANCE CHARACTERISTICS Applicable to the LTC1992-2 only.

Single-Ended Input Small-Signal Step Response

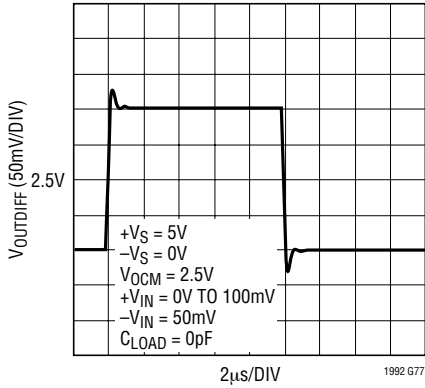

Single-Ended Input Small-Signal Step Response

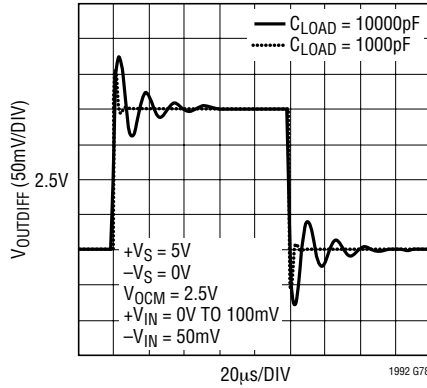

Differential Noise Voltage Density vs Frequency

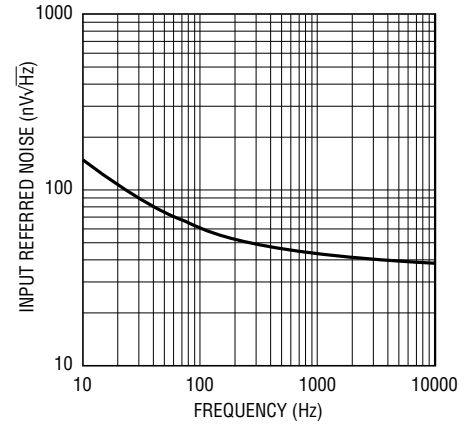

THD + Noise vs Frequency

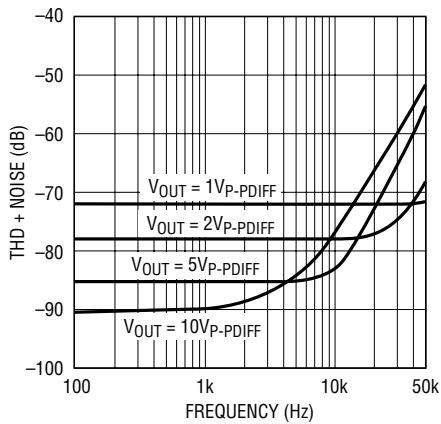

THD + Noise vs Amplitude

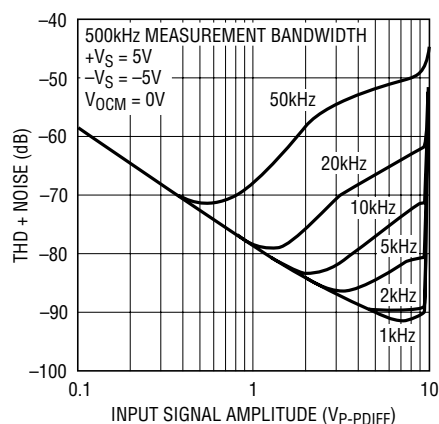

1992 G80

1992 G81

□

TYPICAL PERFORMANCE CHARACTERISTICS Applicable to the LTC1992-5 only.

Differential Input Differential Gain vs Frequency, $V_S = \pm 2.5V$

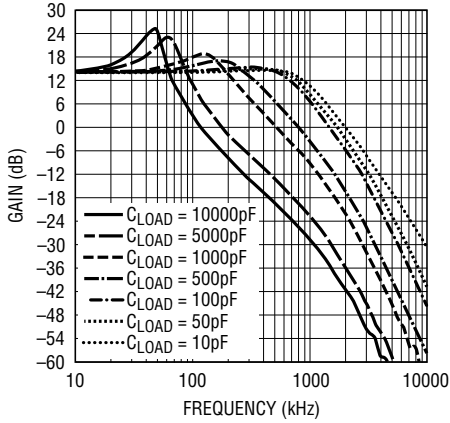

1992 G82

Single-Ended Input Differential Gain vs Frequency, $V_S = \pm 2.5V$

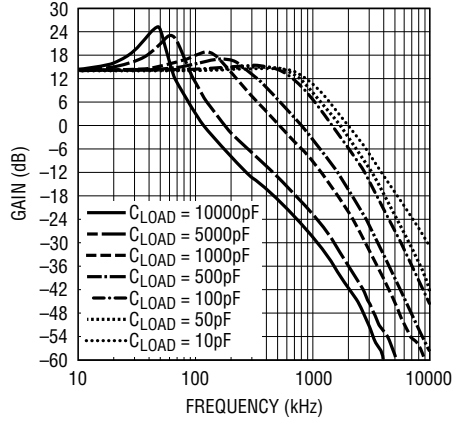

1992 G83

Differential Phase Response vs Frequency

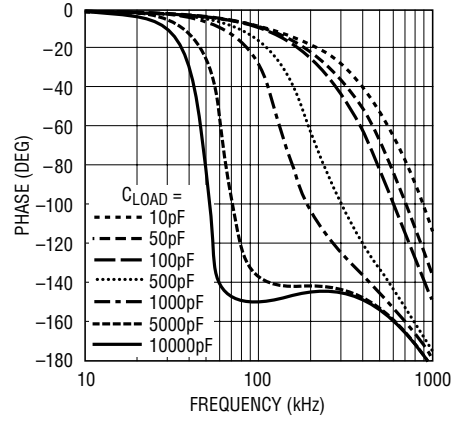

1992 G84

Differential Gain Error vs Temperature

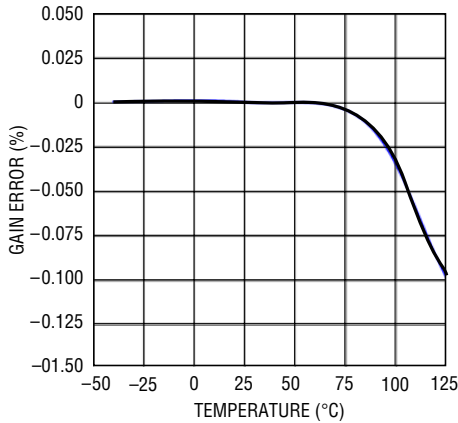

1992 G85

V_{OCM} Gain vs Frequency

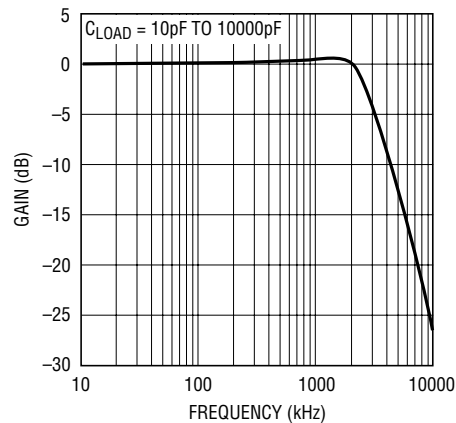

1992 G86

Differential Input Offset Voltage vs Input Common Mode Voltage

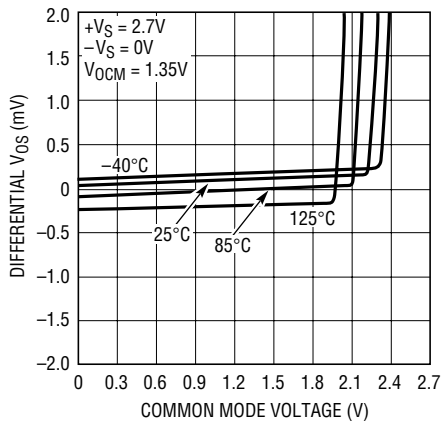

1922 G87

Differential Input Offset Voltage vs Input Common Mode Voltage

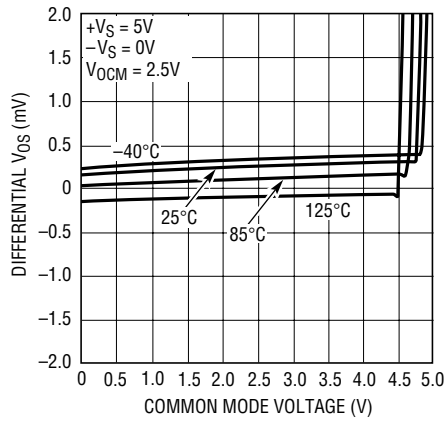

1922 G88

Differential Input Offset Voltage vs Input Common Mode Voltage

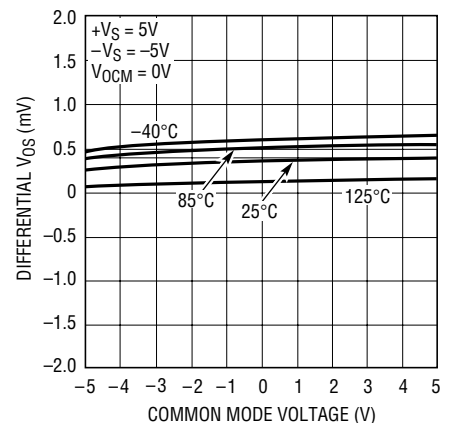

1922 G89

TYPICAL PERFORMANCE CHARACTERISTICS Applicable to the LTC1992-5 only.

Differential Input Large-Signal Step Response

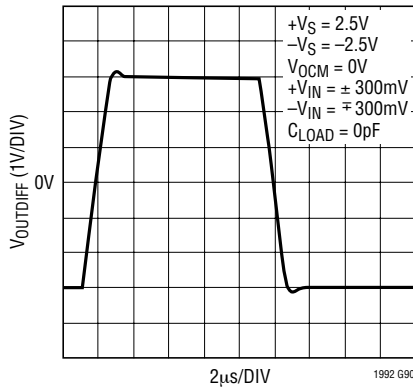

Differential Input Large-Signal Step Response

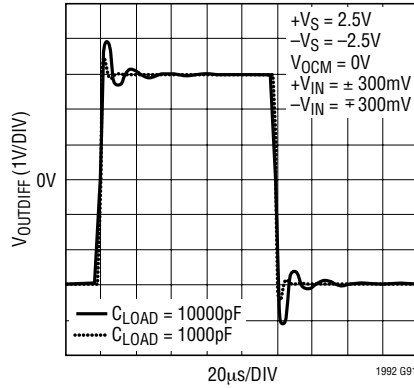

Common Mode Rejection Ratio vs Frequency (Note 7)

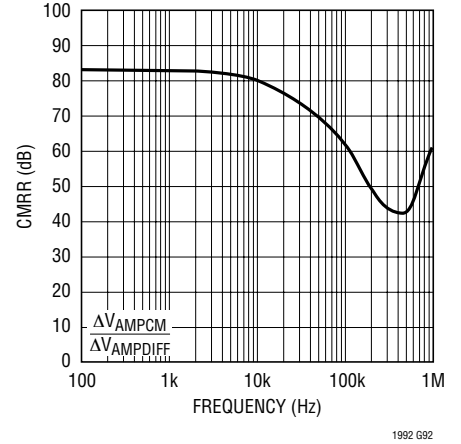

Single-Ended Input Large-Signal Step Response

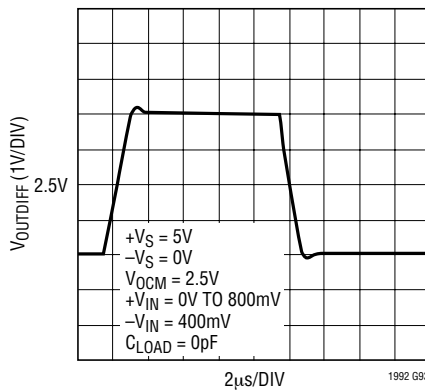

Single-Ended Input Large-Signal Step Response

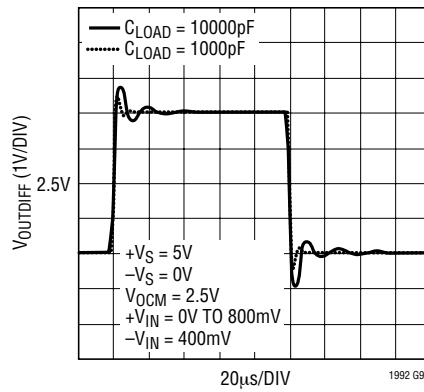

Power Supply Rejection Ratio vs Frequency (Note 7)

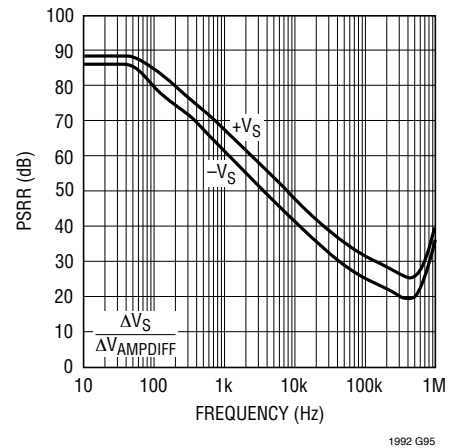

Differential Input Small-Signal Step Response

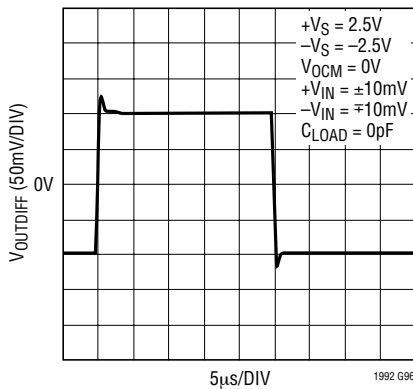

Differential Input Small-Signal Step Response

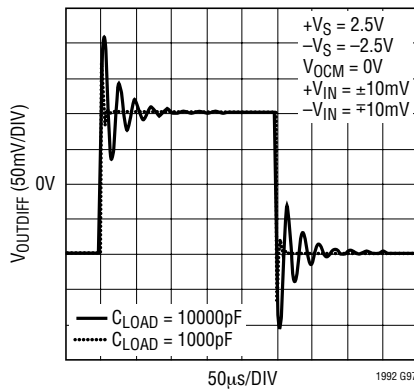

Output Balance vs Frequency

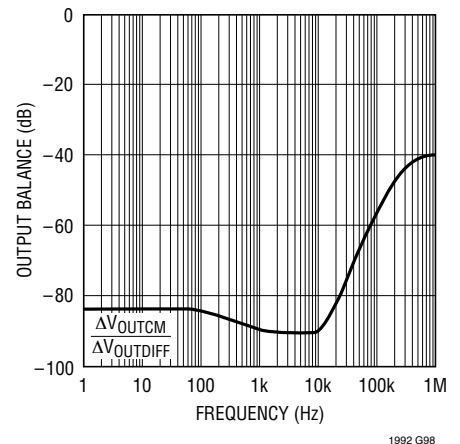

TYPICAL PERFORMANCE CHARACTERISTICS Applicable to the LTC1992-5 only.

Single-Ended Input Small-Signal Step Response

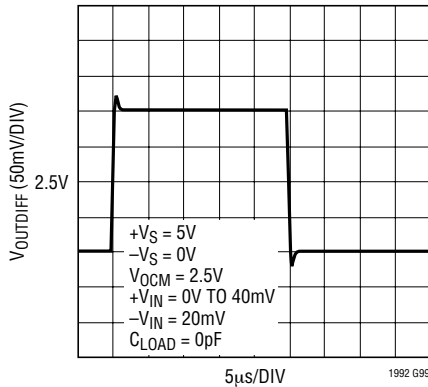

Single-Ended Input Small-Signal Step Response

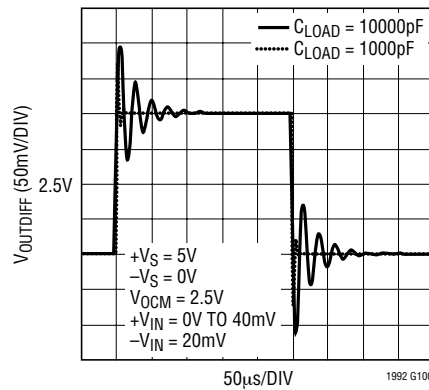

Differential Noise Voltage Density vs Frequency

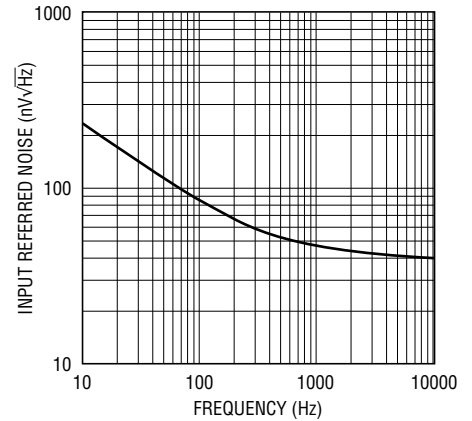

THD + Noise vs Frequency

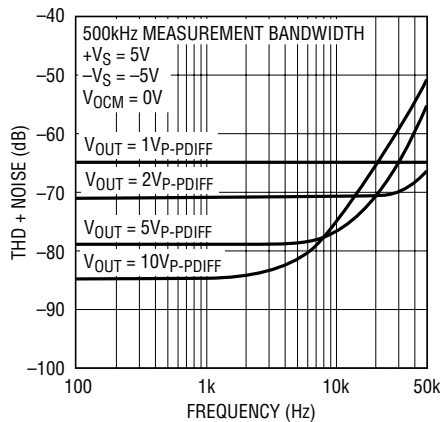

THD + Noise vs Amplitude

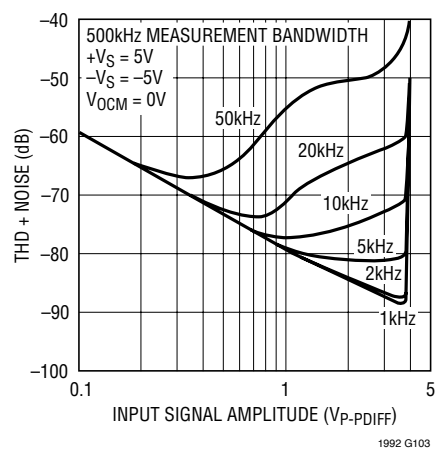

TYPICAL PERFORMANCE CHARACTERISTICS Applicable to the LTC1992-10 only.

Differential Input Differential Gain vs Frequency, $V_S = \pm 2.5V$

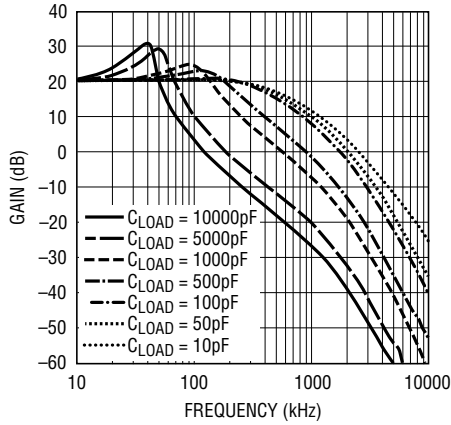

1992 G104

Single-Ended Input Differential Gain vs Frequency, $V_S = \pm 2.5V$

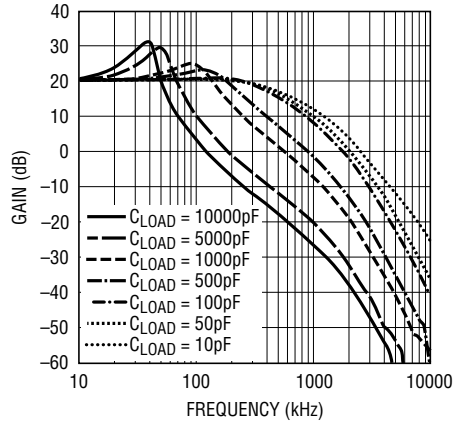

1992 G105

Differential Phase Response vs Frequency

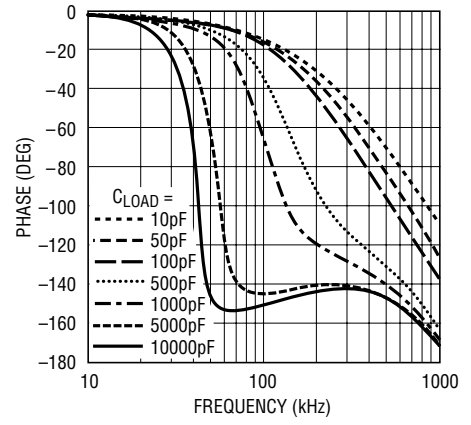

1992 G106

Differential Gain Error vs Temperature

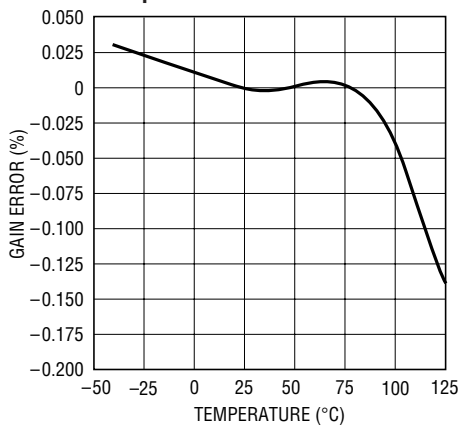

1992 G107

V_{OCM} Gain vs Frequency

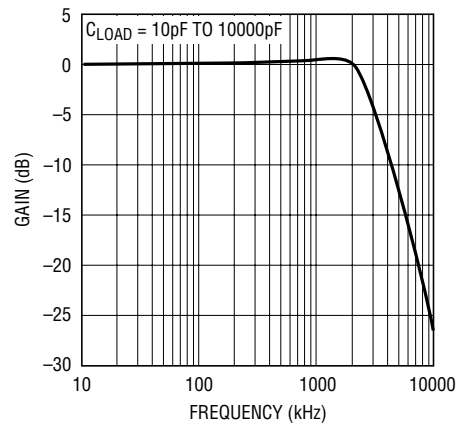

1992 G108

Differential Input Offset Voltage vs Input Common Mode Voltage

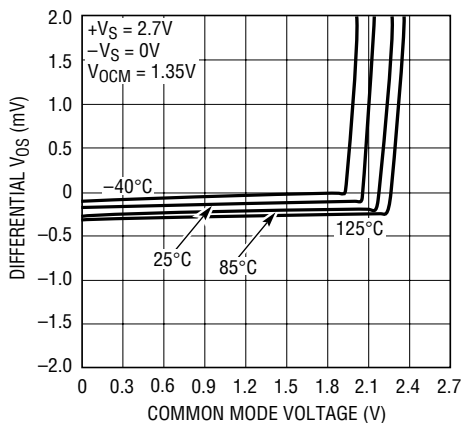

1992 G109

Differential Input Offset Voltage vs Input Common Mode Voltage

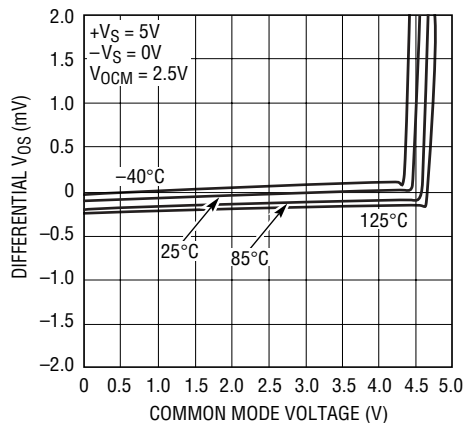

1992 G110

Differential Input Offset Voltage vs Input Common Mode Voltage

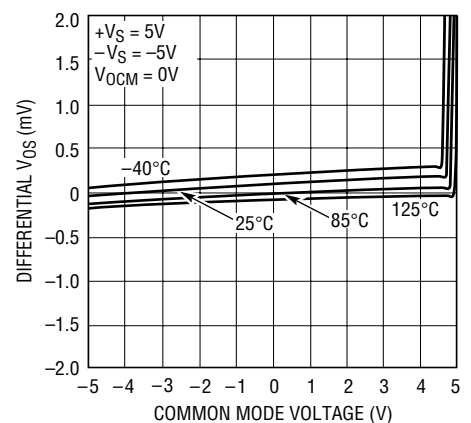

1992 G111

TYPICAL PERFORMANCE CHARACTERISTICS Applicable to the LTC1992-10 only.

Differential Input Large-Signal Step Response

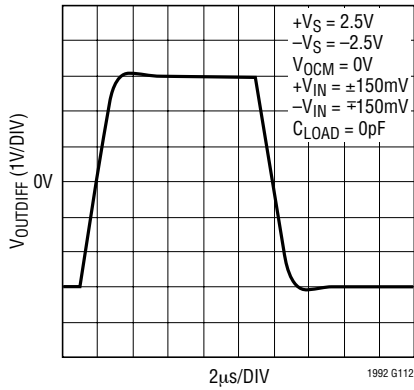

Differential Input Large-Signal Step Response

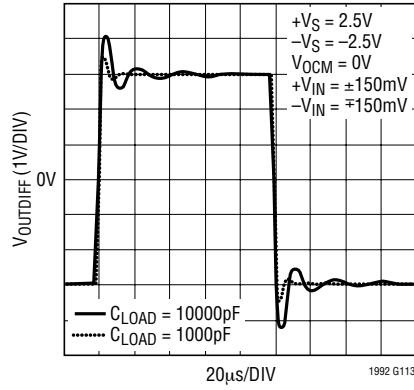

Common Mode Rejection Ratio vs Frequency (Note 7)

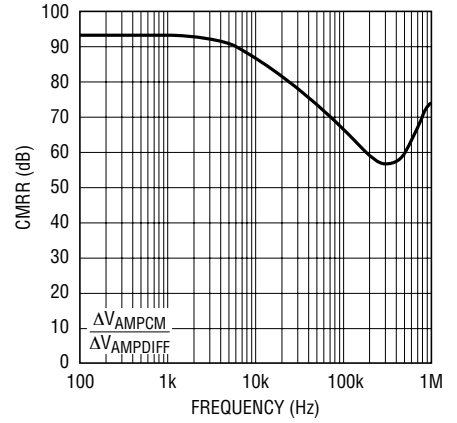

Single-Ended Input Large-Signal Step Response

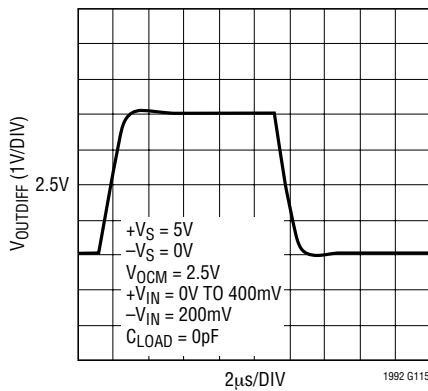

Single-Ended Input Large-Signal Step Response

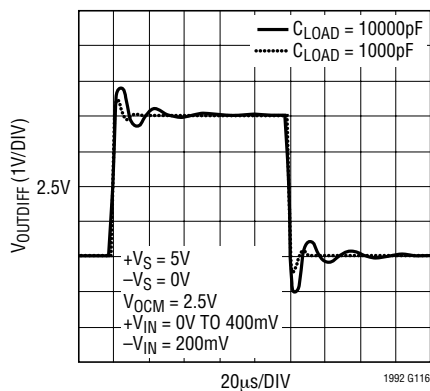

Power Supply Rejection Ratio vs Frequency (Note 7)

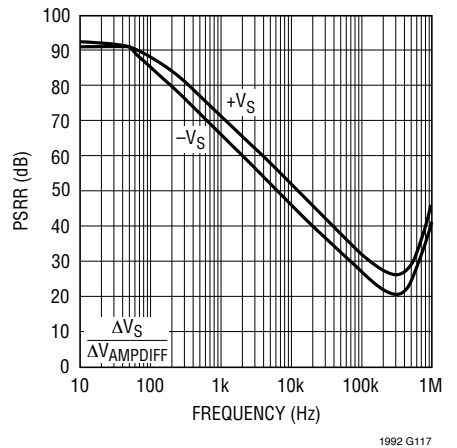

Differential Input Small-Signal Step Response

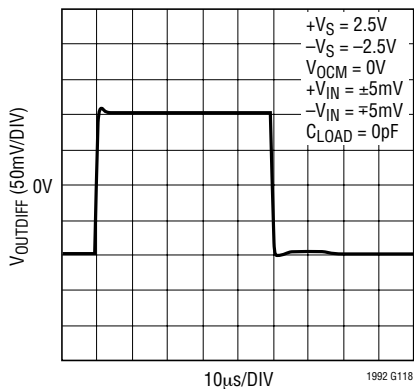

Differential Input Small-Signal Step Response

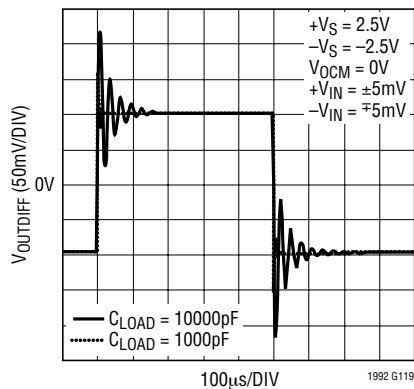

Output Balance vs Frequency

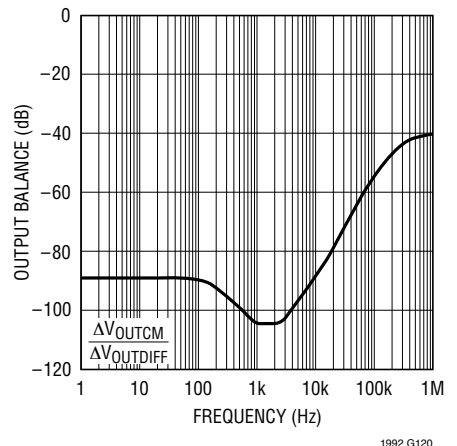

TYPICAL PERFORMANCE CHARACTERISTICS Applicable to the LTC1992-10 only.

Single-Ended Input Small-Signal Step Response

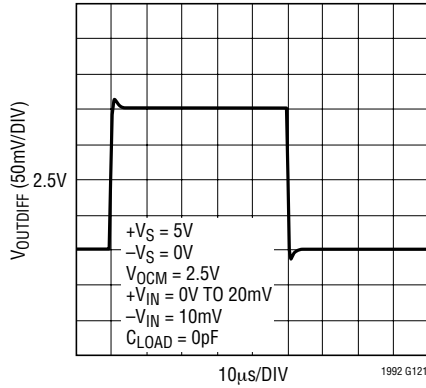

Single-Ended Input Small-Signal Step Response

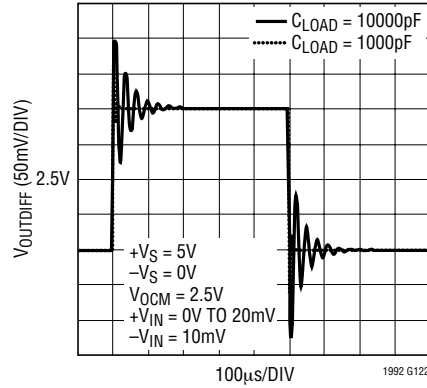

Differential Noise Voltage Density vs Frequency

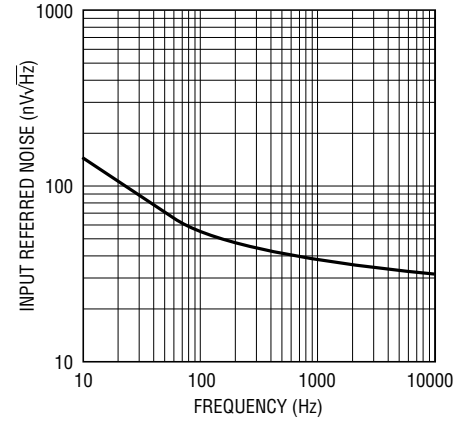

THD + Noise vs Frequency

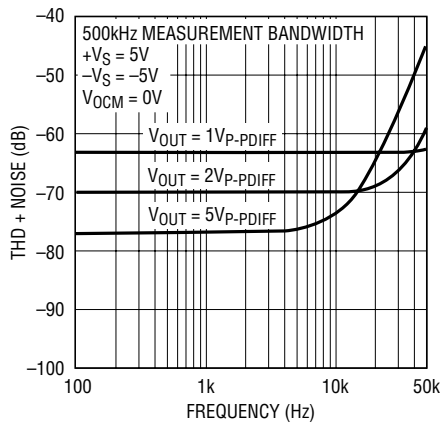

THD + Noise vs Amplitude

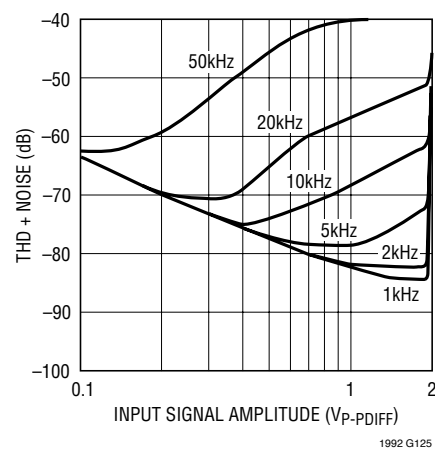

PIN FUNCTIONS

-IN, +IN (Pins 1, 8): Inverting and Noninverting Inputs of the Amplifier. For the LTC1992 part, these pins are connected directly to the amplifier's P-channel MOSFET input devices. The fixed gain LTC1992-X parts have precision, on-chip gain setting resistors. The input resistors are nominally 30k for the LTC1992-1, LTC1992-2 and LTC1992-5 parts. The input resistors are nominally 15k for the LTC1992-10 part.

V_{OCM} (Pin 2): Output Common Mode Voltage Set Pin. The voltage on this pin sets the output signal's common mode voltage level. The output common mode level is set independent of the input common mode level. This is a high impedance input and must be connected to a known and controlled voltage. It must never be left floating.

+V_S, -V_S (Pins 3, 6): The +V_S and -V_S power supply pins should be bypassed with 0.1μF capacitors to an adequate analog ground or ground plane. The bypass capacitors should be located as closely as possible to the supply pins.

+OUT, -OUT (Pins 4, 5): The Positive and Negative Outputs of the Amplifier. These rail-to-rail outputs are designed to drive capacitive loads as high as 10,000pF.

V_{MID} (Pin 7): Mid-Supply Reference. This pin is connected to an on-chip resistive voltage divider to provide a mid-supply reference. This provides a convenient way to set the output common mode level at half-supply. If used for this purpose, Pin 2 will be shorted to Pin 7, Pin 7 should be bypassed with a 0.1μF capacitor to ground. If this reference voltage is not used, leave the pin floating.

BLOCK DIAGRAMS (1992)

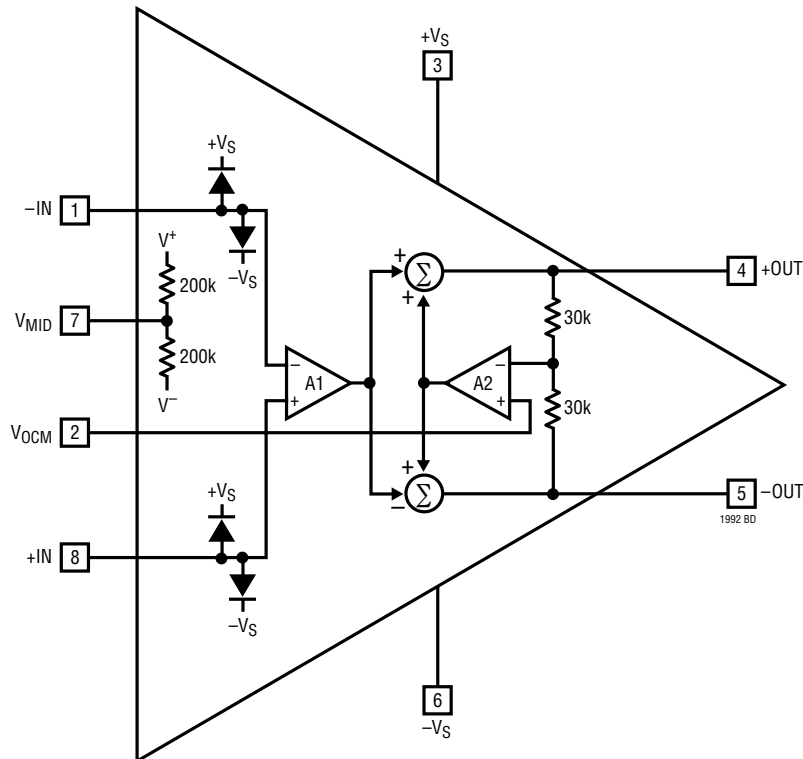

BLOCK DIAGRAMS (1992-X)

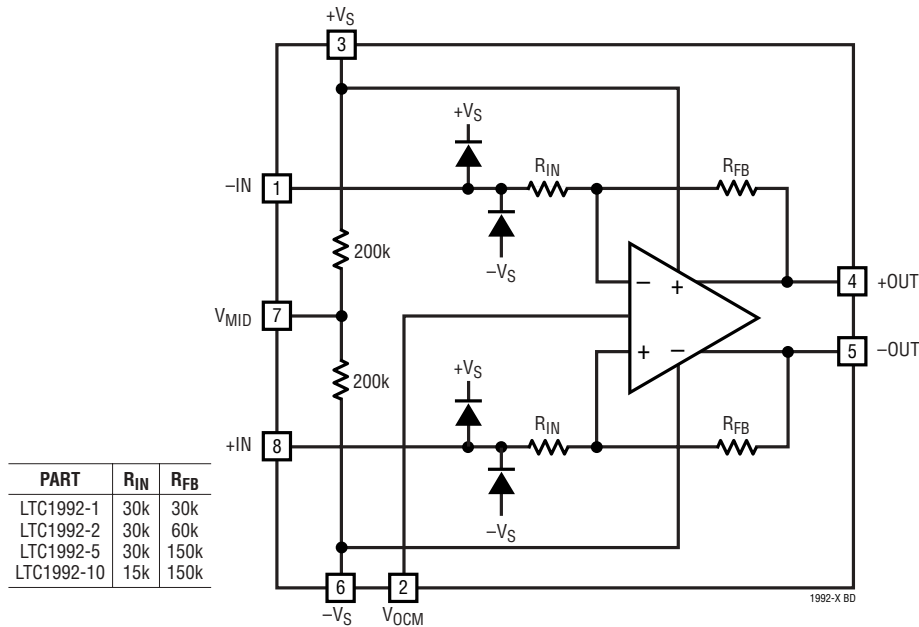

APPLICATIONS INFORMATION

Theory of Operation

The LTC1992 family consists of five fully differential, low power amplifiers. The LTC1992 is an unconstrained fully differential amplifier. The LTC1992-1, LTC1992-2, LTC1992-5 and LTC1992-10 are fixed gain blocks (with gains of 1, 2, 5 and 10 respectively) featuring precision on-chip resistors for accurate and ultra stable gain.

In many ways, a fully differential amplifier functions much like the familiar, ubiquitous op amp. However, there are several key areas where the two differ. Referring to Figure 1, an op amp has a differential input, a high open-loop gain and utilizes negative feedback (through resistors) to set the closed-loop gain and thus control the amplifier's gain with great precision. A fully differential amplifier has all of these features plus an additional input and a complementary output. The complementary output reacts to the input signal in the same manner as the other output, but in the opposite direction. Two outputs changing in an equal but opposite manner require a common reference point (i.e., opposite relative to what?). The additional input, the V_{OCM} pin, sets this reference point. The voltage on the V_{OCM} input directly sets the output signal's com-

mon mode voltage and allows the output signal's common mode voltage to be set completely independent of the input signal's common mode voltage. **Uncoupling the input and output common mode voltages makes signal level shifting easy.**

For a better understanding of the operation of a fully differential amplifier, refer to Figure 2. Here, the LTC1992 functional block diagram adds external resistors to realize a basic gain block. Note that the LTC1992 functional block diagram is not an *exact* replica of the LTC1992 circuitry. However, the Block Diagram is correct and is a very good tool for understanding the operation of fully differential amplifier circuits. Basic op amp fundamentals together with this block diagram provide all of the tools needed for understanding fully differential amplifier circuit applications.

The LTC1992 Block Diagram has two op amps, two summing blocks (pay close attention the **signs**) and four resistors. Two resistors, R_{MID1} and R_{MID2} , connect directly to the V_{MID} pin and simply provide a convenient midsupply reference. Its use is optional and it is not involved in the operation of the LTC1992's amplifier. The LTC1992 functions through the use of two servo networks

APPLICATIONS INFORMATION

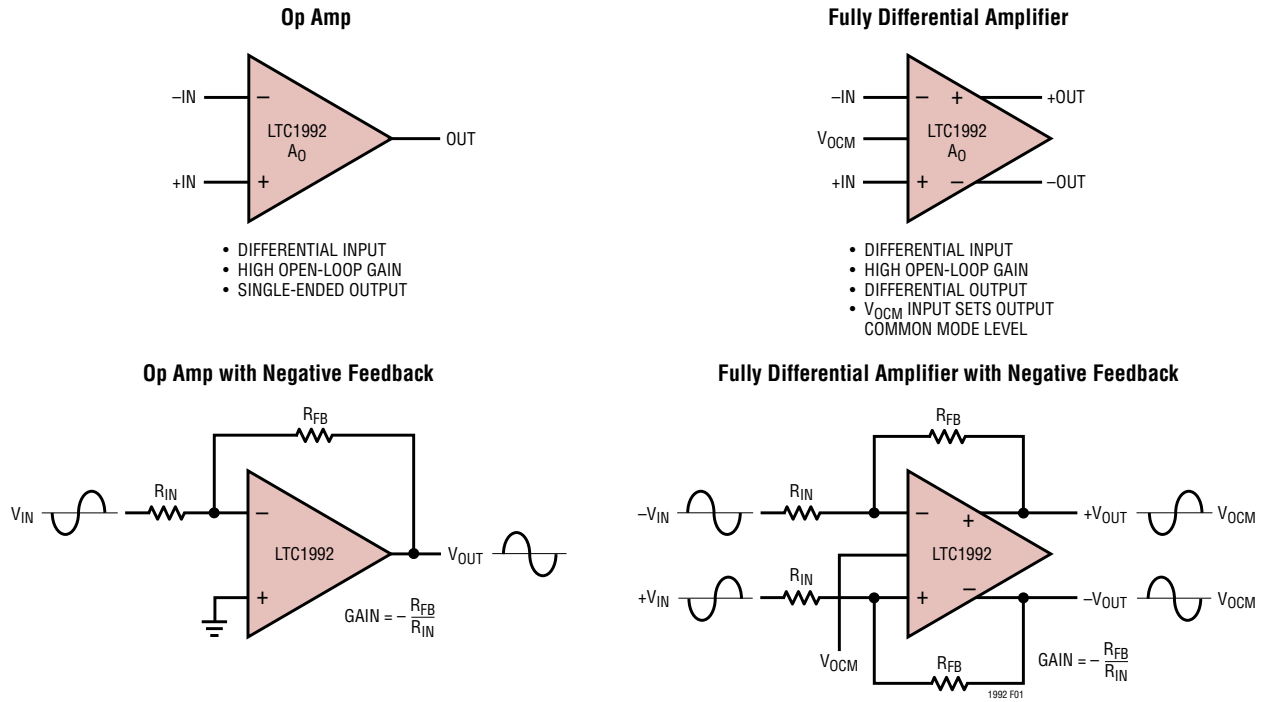

Figure 1. Comparison of an Op Amp and a Fully Differential Amplifier

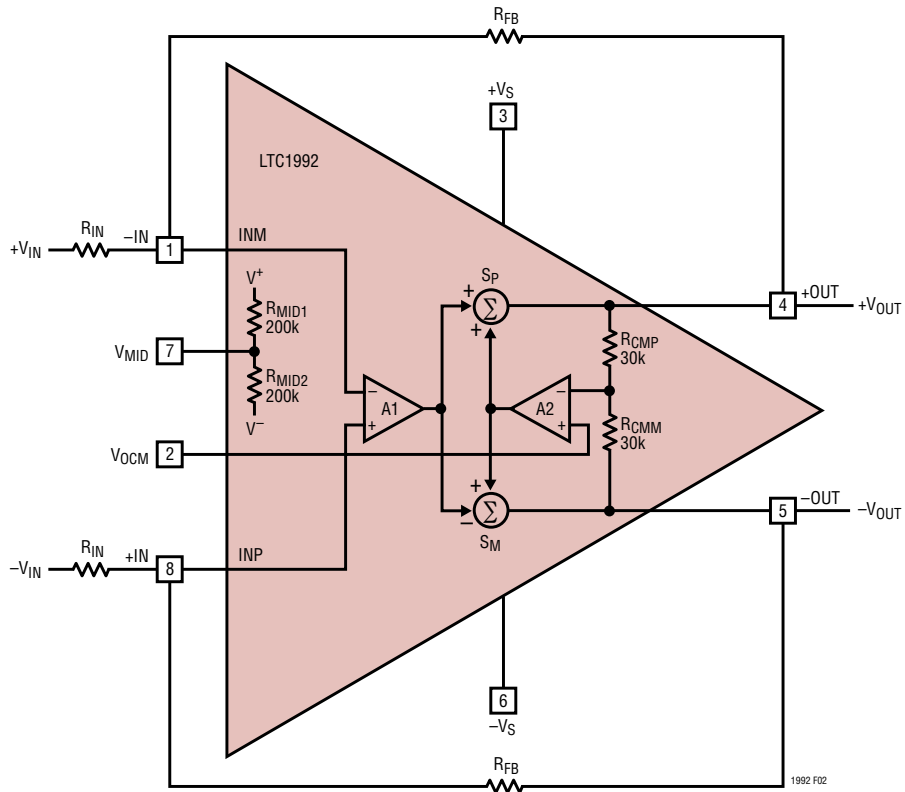

Figure 2. LTC1992 Functional Block Diagram with External Gain Setting Resistors

APPLICATIONS INFORMATION

each employing negative feedback and using an op amp's differential input to create the servo's summing junction.

One servo controls the signal gain path. The differential input of op amp A1 creates the summing junction of this servo. Any voltage present at the input of A1 is amplified (by the op amp's large open-loop gain), sent to the summing blocks and then onto the outputs. Taking note of the signs on the summing blocks, op amp A1's output moves +OUT and -OUT in **opposite** directions. Applying a voltage step at the INM node increases the +OUT voltage while the -OUT voltage decreases. The R_{FB} resistors connect the outputs to the appropriate inputs establishing negative feedback and closing the servo's loop. Any servo loop always attempts to drive its error voltage to zero. In this servo, the error voltage is the voltage between the INM and INP nodes, thus A1 will force the voltages on the INP and INM nodes to be equal (within the part's DC offset, open loop gain and bandwidth limits). The "virtual short" between the two inputs is conceptually the same as that for op amps and is critical to understanding fully differential amplifier applications.

The other servo controls the output common mode level. The differential input of op amp A2 creates the summing junction of this servo. Similar to the signal gain servo above, any voltage present at the input of A2 is amplified, sent to the summing blocks and then onto the outputs. However, in this case, both outputs move in the **same** direction. The resistors R_{CMP} and R_{CMM} connect the +OUT and -OUT outputs to A2's inverting input establishing negative feedback and closing the servo's loop. The midpoint of resistors R_{CMP} and R_{CMM} derives the output's common mode level (i.e., its average). This measure of the output's common mode level connects to A2's inverting input while A2's noninverting input connects directly to the V_{OCM} pin. A2 forces the voltages on its inverting and noninverting inputs to be equal. In other words, it forces the output common mode voltage to be equal to the voltage on the V_{OCM} input pin.

For any fully differential amplifier application to function properly both the signal gain servo and the common mode level servo must be satisfied. When analyzing an applications circuit, the INP node voltage must equal the INM node voltage **and** the output common mode voltage must equal the V_{OCM} voltage. If either of these servos is taken

out of the specified areas of operation (e.g., inputs taken beyond the common mode range specifications, outputs hitting the supply rails or input signals varying faster than the part can track), the circuit will not function properly.

Fully Differential Amplifier Signal Conventions

Fully differential amplifiers have a multitude of signals and signal ranges to consider. To maintain proper operation with conventional op amps, the op amp's inputs and its output must not hit the supply rails and the input signal's common mode level must also be within the part's specified limits. These considerations also apply to fully differential amplifiers, but here there is an additional output to consider and common mode level shifting complicates matters. Figure 3 provides a list of the many signals and specifications as well as the naming convention. The phrase "common mode" appears in many places and often leads to confusion. The fully differential amplifier's ability to uncouple input and output common mode levels yields great design flexibility, but also complicates matters some. For simplicity, the equations in Figure 3 also assume an ideal amplifier and perfect resistor matching. For a detailed analysis, consult the fully differential amplifier applications circuit analysis section..

Basic Applications Circuits

Most fully differential amplifier applications circuits employ symmetrical feedback networks and are familiar territory for op amp users. Symmetrical feedback networks require that the $-V_{IN}/+V_{OUT}$ network is a mirror image duplicate of the $+V_{IN}/-V_{OUT}$ network. Each of these half circuits is basically just a standard inverting gain op amp circuit. Figure 4 shows three basic inverting gain op amp circuits and their corresponding fully differential amplifier cousins. The vast majority of fully differential amplifier circuits derive from old tried and true inverting op amp circuits. To create a fully differential amplifier circuit from an inverting op amp circuit, first simply transfer the op amp's V_{IN}/V_{OUT} network to the fully differential amplifier's $-V_{IN}/+V_{OUT}$ nodes. Then, take a mirror image duplicate of the network and apply it to the fully differential amplifier's $+V_{IN}/-V_{OUT}$ nodes. Op amp users can comfortably transfer any inverting op amp circuit to a fully differential amplifier in this manner.

APPLICATIONS INFORMATION

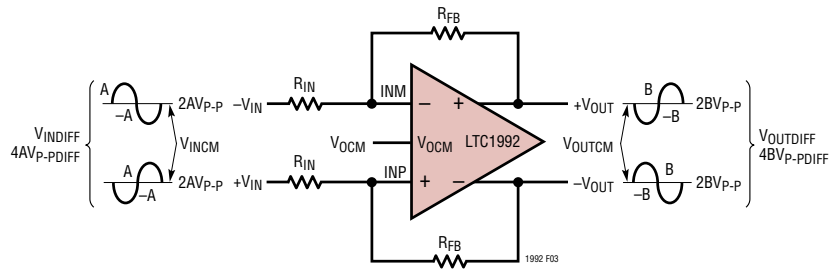

$$\begin{aligned} \text{DIFFERENTIAL INPUT VOLTAGE} &= V_{INDIFF} = +V_{IN} - -V_{IN} & \text{DIFFERENTIAL OUTPUT VOLTAGE} &= V_{OUTDIFF} = +V_{OUT} - -V_{OUT} \\ \text{INPUT COMMON MODE VOLTAGE} &= V_{INCM} = \frac{+V_{IN} + -V_{IN}}{2} & \text{OUTPUT COMMON MODE VOLTAGE} &= V_{OUTCM} = \frac{+V_{OUT} + -V_{OUT}}{2} \\ +V_{OUT} &= \left(+V_{IN} - -V_{IN} \right) \cdot \frac{1}{2} \cdot \frac{R_{FB}}{R_{IN}} + V_{OCM} \quad ; V_{OSCM} = 0V \\ -V_{OUT} &= \left(-V_{IN} - +V_{IN} \right) \cdot \frac{1}{2} \cdot \frac{R_{FB}}{R_{IN}} + V_{OCM} \quad ; V_{OSCM} = 0V \\ V_{OUTDIFF} &= V_{INDIFF} \cdot \frac{R_{FB}}{R_{IN}} \\ V_{AMPDIFF} &= V_{INP} - V_{INM} \\ V_{AMPCM} &= \frac{V_{INP} + V_{INM}}{2} \\ V_{OUTCM} &= V_{OCM} \\ CMRR &= \frac{\Delta V_{AMPCM}}{\Delta V_{AMPDIFF}} \quad ; +V_{IN} = -V_{IN} \\ \text{OUTPUT BALANCE} &= \frac{\Delta V_{OUTCM}}{\Delta V_{OUTDIFF}} \\ e_{NOUT} &= \left(\frac{R_{FB}}{R_{IN}} + 1 \right) \cdot \sqrt{e_{NIN}^2 + r_N^2} \quad \text{WHERE: } e_{NOUT} = \text{OUTPUT REFERRED NOISE VOLTAGE DENSITY} \\ & & e_{NIN} = \text{INPUT REFERRED NOISE VOLTAGE DENSITY} \\ & & r_N = (0.13nV/\sqrt{Hz}) \left(\frac{R_{IN} \cdot R_{FB}}{R_{IN} + R_{FB}} \right) \\ & & \text{(RESISTIVE NOISE IS ALREADY INCLUDED IN THE SPECIFICATIONS FOR THE FIXED GAIN LTC1992-X PARTS)} \\ V_{OSDIFFOUT} &= V_{OSDIFFIN} \cdot \left(\frac{R_{FB}}{R_{IN}} + 1 \right) \\ V_{OSCM} &= V_{OUTCM} - V_{OCM} \end{aligned}$$

Figure 3. Fully Differential Amplifier Signal Conventions (Ideal Amplifier and Perfect Resistor Matching is Assumed)

Single-Ended to Differential Conversion

One of the most important applications of fully differential amplifiers is single-ended signaling to differential signaling conversion. Many systems have a single-ended signal that must connect to an ADC with a differential input. The ADC could be run in a single-ended manner, but performance usually degrades. Fortunately, all of basic applications circuits shown in Figure 4, as well as all of the fixed gain LTC1992-X parts, are equally suitable for both differential and single-ended input signals. For single-ended input signals, connect one of the inputs to a reference voltage (e.g., ground or midsupply) and connect the other to the signal path. There are no tradeoffs here as the part's performance is the same with single-ended or differential input signals. Which input is used

for the signal path only affects the polarity of the differential output signal.

Signal Level Shifting

Another important application of fully differential amplifier is signal level shifting. Single-ended to differential conversion accompanied by a signal level shift is very commonplace when driving ADCs. As noted in the theory of operation section, fully differential amplifiers have a common mode level servo that determines the output common mode level independent of the input common mode level. To set the output common mode level, simply apply the desired voltage to the V_{OCM} input pin. The voltage range on the V_{OCM} pin is from (-V_S + 0.5V) to (+V_S - 1.3V).

APPLICATIONS INFORMATION

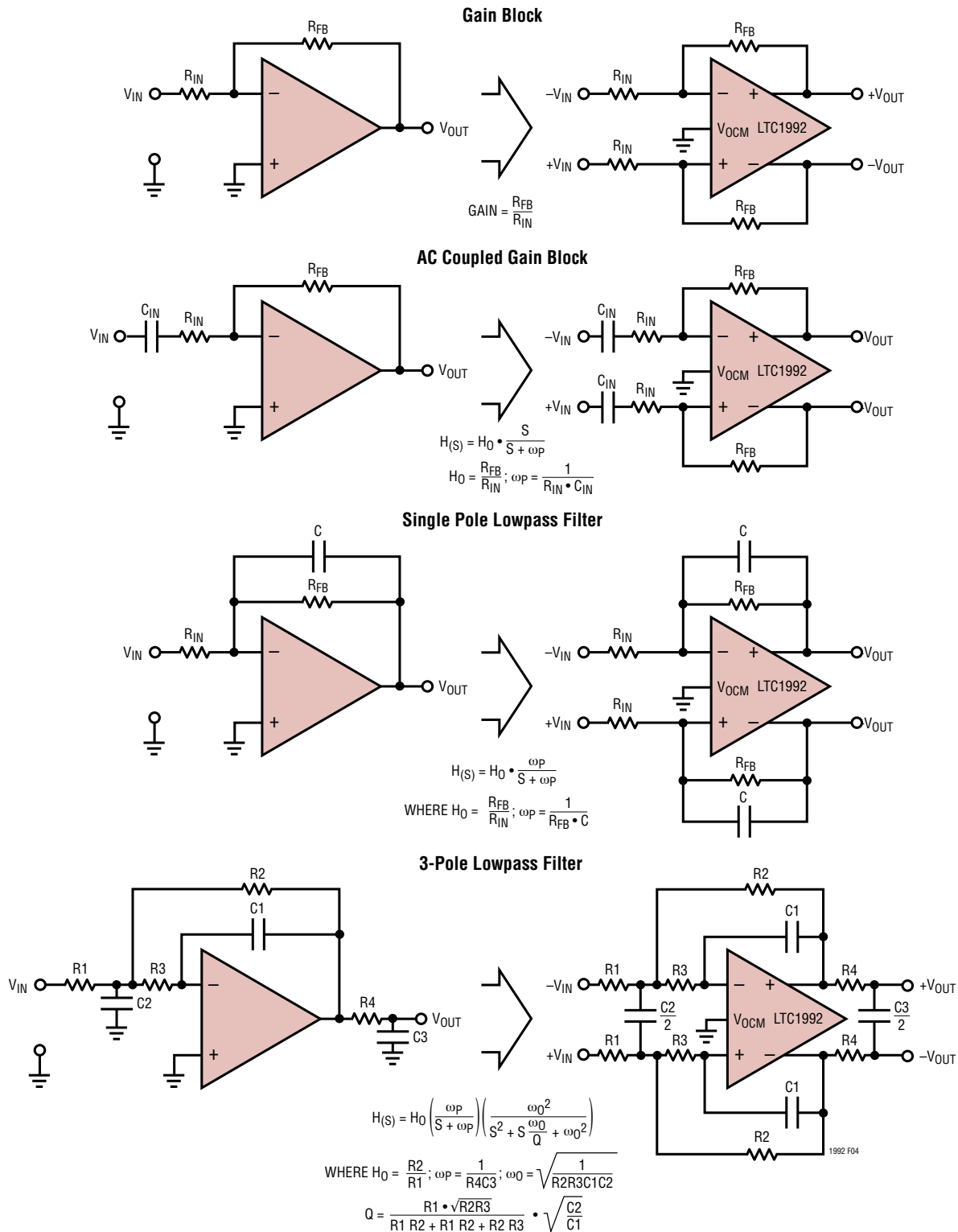

Figure 4. Basic Fully Differential Amplifier Application Circuits (Note: Single-Ended to Differential Conversion is Easily Accomplished by Connecting One of the Input Nodes, +VIN or -VIN, to a DC Reference Level (e.g., Ground))

APPLICATIONS INFORMATION

The V_{OCM} input pin has a very high input impedance and is easily driven by even the weakest of sources. Many ADCs provide a voltage reference output that defines either its common mode level or its full-scale level. Apply the ADC's reference potential either directly to the V_{OCM} pin or through a resistive voltage divider depending on the reference voltage's definition. When controlling the V_{OCM} pin by a high impedance source, connect a bypass capacitor (1000pF to 0.1 μ F) from the V_{OCM} pin to ground to lower the high frequency impedance and limit external noise coupling. Other applications will want the output biased at a midpoint of the power supplies for maximum output voltage swing. For these applications, the LTC1992 provides a midsupply potential at the V_{MID} pin. The V_{MID} pin connects to a simple resistive voltage divider with two 200k resistors connected between the supply pins. To use this feature, connect the V_{MID} pin to the V_{OCM} pin and bypass this node with a capacitor.

One undesired effect of utilizing the level shifting function is an increase in the differential output offset voltage due to gain setting resistor mismatch. The offset is approximately the amount of level shift ($V_{OUTCM} - V_{INCM}$) multiplied by the amount of resistor mismatch. For example, a 2V level shift with 0.1% resistors will give around 2mV of output offset ($2 \cdot 0.1\% = 2\text{mV}$). The exact amount of offset is dependent on the application's gain and the resistor mismatch. For a detail description, consult the Fully Differential Amplifier Applications Circuit Analysis section.

CMRR and Output Balance

One common misconception of fully differential amplifiers is that the common mode level servo guarantees an infinite common mode rejection ratio (CMRR). This is not true. The common mode level servo does, however, force the two outputs to be truly complementary (i.e., exactly opposite or 180 degrees out of phase). Output balance is a measure of how complementary the two outputs are.

At low frequencies, CMRR is primarily determined by the matching of the gain setting resistors. Like any op amp, the LTC1992 does not have infinite CMRR, however resistor mismatching of only 0.018%, halves the circuit's CMRR. Standard 1% tolerance resistors yield a CMRR of about 40dB. For most applications, resistor matching

dominates low frequency CMRR performance. The specifications for the fixed gain LTC1992-X parts include the on-chip resistor matching effects. Also, note that an *input common mode* signal appears as a *differential output* signal reduced by the CMRR. As with op amps, at higher frequencies the CMRR degrades. Refer to the Typical Performance plots for the details of the CMRR performance over frequency.

At low frequencies, the output balance specification is determined by the matching of the on-chip R_{CMM} and R_{CMP} resistors. At higher frequencies, the output balance degrades. Refer to the typical performance plots for the details of the output balance performance over frequency.

Input Impedance

The input impedance for a fully differential amplifier application circuit is similar to that of a standard op amp inverting amplifier. One major difference is that the input impedance is different for differential input signals and single-ended signals. Referring to Figure 3, for differential input signals the input impedance is expressed by the following expression:

$$R_{INDIFF} = 2 \cdot R_{IN}$$

For single-ended signals, the input impedance is expressed by the following expression:

$$R_{INS-E} = \frac{R_{IN}}{1 - \frac{R_{FB}}{2 \cdot (R_{IN} + R_{FB})}}$$

The input impedance for single-ended signals is slightly higher than the R_{IN} value since some of the input signal is fed back and appears as the amplifier's input common mode level. This small amount of positive feedback increases the input impedance.

Driving Capacitive Loads

The LTC1992 family of parts is stable for all capacitive loads up to at least 10,000pF. While stability is guaranteed, the part's performance is not unaffected by capacitive loading. Large capacitive loads increase output step response ringing and settling time, decrease the bandwidth

APPLICATIONS INFORMATION

and increase the frequency response peaking. Refer to the Typical Performance plots for small-signal step response, large-signal step response and gain over frequency to appraise the effects of capacitive loading. While the consequences are minor in most instances, consider these effects when designing application circuits with large capacitive loads.

Input Signal Amplitude Considerations

For application circuits to operate correctly, the amplifier must be in its linear operating range. To be in the linear operating range, the input signal's common mode voltage must be within the part's specified limits and the rail-to-rail outputs must stay within the supply voltage rails. Additionally, the fixed gain LTC1992-X parts have input protection diodes that limit the input signal to be within the supply voltage rails. The unconstrained LTC1992 uses external resistors allowing the source signals to go beyond the supply voltage rails.

When taken outside of the linear operating range, the circuit does not perform as expected, however nothing extreme occurs. Outputs driven into the supply voltage rails are simply clipped. There is no phase reversal or oscillation. Once the outputs return to the linear operating range, there is a small recovery time, then normal operation proceeds. When the input common mode voltage is below the specified lower limit, on-chip protection diodes conduct and clamp the signal. Once the signal returns to the specified operating range, normal operation proceeds. If the input common mode voltage goes slightly above the specified upper limit (by no more than about 500mV), the amplifier's open-loop gain reduces and DC offset and closed-loop gain errors increase. Return the input back to the specified range and normal performance commences. If taken well above the upper limit, the amplifier's input stage is cut off. The gain servo is now open loop; however, the common mode servo is still functional. Output balance is maintained and the outputs go to opposite supply rails. However, which output goes to which supply rail is

random. Once the input returns to the specified input common mode range, there is a small recovery time then normal operation proceeds.

The LTC1992's input signal common mode range (V_{INCMR}) is from $(-V_S - 0.1V)$ to $(+V_S - 1.3V)$. This specification applies to the voltage at the **amplifier's** input, the INP and INM nodes of Figure 2. The specifications for the fixed gain LTC1992-X parts reflect a higher maximum limit as this specification is for the entire gain block and references the signal at the input resistors. Differential input signals and single-ended signals require a slightly different set of formulae. Differential signals separate very nicely into common mode and differential components while single ended signals do not. Refer to Figure 5 for the formulae for calculating the available signal range. Additionally, Table 1 lists some common configurations and their appropriate signal levels.

The LTC1992's outputs allow rail-to-rail signal swings. The output voltage on either output is a function of the input signal's amplitude, the gain configured and the output signal's common mode level set by the V_{OCM} pin. For maximum signal swing, the V_{OCM} pin is set at the midpoint of the supply voltages. For other applications, such as an ADC driver, the required level must fall within the V_{OCM} range of $(-V_S + 0.5V)$ to $(+V_S - 1.3V)$. For single-ended input signals, it is not always obvious which output will clip first thus both outputs are calculated and the minimum value determines the signal limit. Refer to Figure 5 for the formulae and Table 1 for examples.

To ensure proper linear operation both the input common mode level and the output signal level must be within the specified limits. These same criteria are also present with standard op amps. However, with a fully differential amplifier, it is a bit more complex and old familiar op amp intuition often leads to the wrong result. This is especially true for single-ended to differential conversion with level shifting. The required calculations are a bit tedious, but are necessary to guarantee proper linear operation.

APPLICATIONS INFORMATION

Differential Input Signals

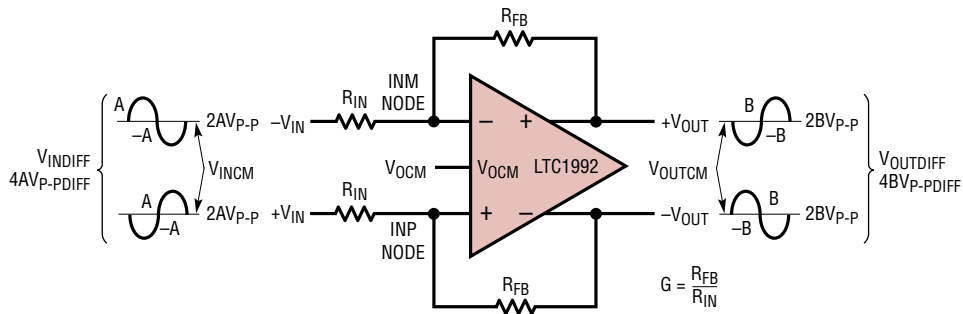

INPUT COMMON MODE LIMITS

A. CALCULATE V_{INCM} MINIMUM AND MAXIMUM GIVEN R_{IN} , R_{FB} AND V_{OCM}

$$V_{INCM(MAX)} = (+V_S - 1.3V) + \frac{1}{G} (+V_S - 1.3V - V_{OCM})$$

$$V_{INCM(MIN)} = (-V_S - 0.1V) + \frac{1}{G} (-V_S - 0.1V - V_{OCM})$$

OR B. WITH A KNOWN V_{INCM} , R_{IN} , R_{FB} AND V_{OCM} , CALCULATE COMMON MODE VOLTAGE AT INP AND INM NODES ($V_{INCM(AMP)}$) AND CHECK THAT IT IS WITHIN THE SPECIFIED LIMITS.

$$V_{INCM(AMP)} = \frac{V_{INP} + V_{INM}}{2} = \frac{G}{G+1} V_{INCM} + \frac{1}{G+1} V_{OCM}$$

OUTPUT SIGNAL CLIPPING LIMIT

$$V_{INDIFF(MAX)}(V_P-PDIFF) = \text{THE LESSER VALUE OF } \frac{4}{G} (+V_S - V_{OCM}) \text{ OR } \frac{4}{G} (V_{OCM} - -V_S)$$

Single End Input Signals

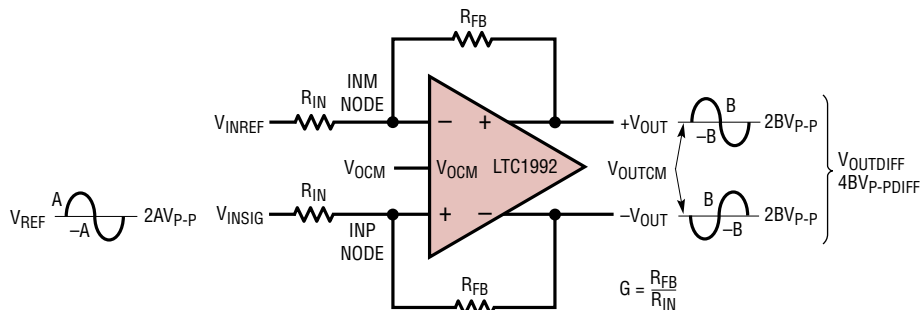

INPUT COMMON MODE LIMITS (NOTE: FOR THE FIXED GAIN LTC1992-X PARTS, V_{INREF} AND V_{INSIG} CANNOT EXCEED THE SUPPLIES)

$$V_{INSIG(MAX)} = 2 \left[\left(+V_S - 1.3V - \frac{V_{INREF}}{2} \right) + \frac{1}{G} \left(+V_S - 1.3V - V_{OCM} \right) \right]$$

$$V_{INSIG(MIN)} = 2 \left[\left(-V_S - 0.1V - \frac{V_{INREF}}{2} \right) + \frac{1}{G} \left(-V_S - 0.1V - V_{OCM} \right) \right]$$

OR

$$V_{INSIGP-P} = 2 \left[\left(+V_S - -V_S - 1.2V \right) + \frac{1}{G} \left(+V_S - -V_S - 1.2V \right) \right]$$

OUTPUT SIGNAL CLIPPING LIMIT

$$V_{INSIG(MAX)} = \text{THE LESSER VALUE OF } V_{INREF} + \frac{2}{G} (+V_S - V_{OCM}) \text{ OR } V_{INREF} + \frac{2}{G} (V_{OCM} - -V_S)$$

$$V_{INSIG(MIN)} = \text{THE GREATER VALUE OF } V_{INREF} + \frac{2}{G} (-V_S - V_{OCM}) \text{ OR } V_{INREF} + \frac{2}{G} (V_{OCM} - +V_S) \quad 1992 F05$$

Figure 5. Input Signal Limitations

APPLICATIONS INFORMATION

Table 1. Input Signal Limitations for Some Common Applications

Differential Input Signal, V_{OCM} at Midsupply. (V_{INCM} must be within the Min and Max table values and V_{INDIFF} must be less than the table value)

| + V_S (V) | - V_S (V) | GAIN (V/V) | V_{OCM} (V) | $V_{INCM(MAX)}$ (V) | $V_{INCM(MIN)}$ (V) | $V_{INDIFF(MAX)}$ ($V_{P-PDIFF}$) | $V_{OUTDIFF(MAX)}$ ($V_{P-PDIFF}$) |
|----------------|----------------|---------------|------------------|------------------------|------------------------|--|---|
| 2.7 | 0 | 1 | 1.35 | 1.450 | -1.550 | 5.40 | 5.40 |
| 2.7 | 0 | 2 | 1.35 | 1.425 | -0.825 | 2.70 | 5.40 |
| 2.7 | 0 | 5 | 1.35 | 1.410 | -0.390 | 1.08 | 5.40 |
| 2.7 | 0 | 10 | 1.35 | 1.405 | -0.245 | 0.54 | 5.40 |
| 5 | 0 | 1 | 2.5 | 4.900 | -2.700 | 10.00 | 10.00 |
| 5 | 0 | 2 | 2.5 | 4.300 | -1.400 | 5.00 | 10.00 |
| 5 | 0 | 5 | 2.5 | 3.940 | -0.620 | 2.00 | 10.00 |
| 5 | 0 | 10 | 2.5 | 3.820 | -0.360 | 1.00 | 10.00 |
| 5 | -5 | 1 | 0 | 7.400 | -10.200 | 20.00 | 20.00 |
| 5 | -5 | 2 | 0 | 5.550 | -7.650 | 10.00 | 20.00 |
| 5 | -5 | 5 | 0 | 4.440 | -6.120 | 4.00 | 20.00 |
| 5 | -5 | 10 | 0 | 4.070 | -5.610 | 2.00 | 20.00 |

Differential Input Signal, V_{OCM} at Typical ADC Levels. (V_{INCM} must be within the Min and Max table values and V_{INDIFF} must be less than the table value)

| + V_S (V) | - V_S (V) | GAIN (V/V) | V_{OCM} (V) | $V_{INCM(MAX)}$ (V) | $V_{INCM(MIN)}$ (V) | $V_{INDIFF(MAX)}$ ($V_{P-PDIFF}$) | $V_{OUTDIFF(MAX)}$ ($V_{P-PDIFF}$) |
|----------------|----------------|---------------|------------------|------------------------|------------------------|--|---|
| 2.7 | 0 | 1 | 1 | 1.800 | -1.200 | 4.00 | 4.00 |
| 2.7 | 0 | 2 | 1 | 1.600 | -0.650 | 2.00 | 4.00 |
| 2.7 | 0 | 5 | 1 | 1.480 | -0.320 | 0.80 | 4.00 |
| 2.7 | 0 | 10 | 1 | 1.440 | -0.210 | 0.40 | 4.00 |
| 5 | 0 | 1 | 2 | 5.400 | -2.200 | 8.00 | 8.00 |
| 5 | 0 | 2 | 2 | 4.550 | -1.150 | 4.00 | 8.00 |
| 5 | 0 | 5 | 2 | 4.040 | -0.520 | 1.60 | 8.00 |
| 5 | 0 | 10 | 2 | 3.870 | -0.310 | 0.80 | 8.00 |
| 5 | -5 | 1 | 2 | 5.400 | -12.200 | 12.00 | 12.00 |
| 5 | -5 | 2 | 2 | 4.550 | -8.650 | 6.00 | 12.00 |
| 5 | -5 | 5 | 2 | 4.040 | -6.520 | 2.40 | 12.00 |
| 5 | -5 | 10 | 2 | 3.870 | -5.810 | 1.20 | 12.00 |

APPLICATIONS INFORMATION

Table 1. Input Signal Limitations for Some Common Applications

Midsupply Referenced Single-Ended Input Signal, V_{OCM} at Midsupply. (The V_{INSIG} Min and Max values listed account for both the input common mode limits and the output clipping)

| $+V_S$ (V) | $-V_S$ (V) | GAIN (V/V) | V_{OCM} (V) | V_{INREF} (V) | $V_{INSIG(MAX)}$ (V) | $V_{INSIG(MIN)}$ (V) | $V_{INSIG-P(MAX)}$ (V_{P-P} AROUND V_{INREF}) | $V_{OUTDIFF(MAX)}$ ($V_{P-PDIFF}$) |
|---------------|---------------|---------------|------------------|--------------------|-------------------------|-------------------------|--|---|
| 2.7 | 0 | 1 | 1.35 | 1.35 | 1.550 | -1.350 | 0.40 | 0.40 |
| 2.7 | 0 | 2 | 1.35 | 1.35 | 1.500 | 0.000 | 0.30 | 0.60 |
| 2.7 | 0 | 5 | 1.35 | 1.35 | 1.470 | 0.810 | 0.24 | 1.20 |
| 2.7 | 0 | 10 | 1.35 | 1.35 | 1.460 | 1.080 | 0.22 | 2.20 |
| 5 | 0 | 1 | 2.5 | 2.5 | 7.300 | -2.500 | 9.60 | 9.60 |
| 5 | 0 | 2 | 2.5 | 2.5 | 5.000 | 0.000 | 5.00 | 10.00 |
| 5 | 0 | 5 | 2.5 | 2.5 | 3.500 | 1.500 | 2.00 | 10.00 |
| 5 | 0 | 10 | 2.5 | 2.5 | 3.000 | 2.000 | 1.00 | 10.00 |
| 5 | -5 | 1 | 0 | 0 | 10.000 | -10.000 | 20.00 | 20.00 |
| 5 | -5 | 2 | 0 | 0 | 5.000 | -5.000 | 10.00 | 20.00 |
| 5 | -5 | 5 | 0 | 0 | 2.000 | -2.000 | 4.00 | 20.00 |
| 5 | -5 | 10 | 0 | 0 | 1.000 | -1.000 | 2.00 | 20.00 |

Midsupply Referenced Single-Ended Input Signal, V_{OCM} at Typical ADC Levels. (The V_{INSIG} Min and Max values listed account for both the input common mode limits and the output clipping)

| $+V_S$ (V) | $-V_S$ (V) | GAIN (V/V) | V_{OCM} (V) | V_{INREF} (V) | $V_{INSIG(MAX)}$ (V) | $V_{INSIG(MIN)}$ (V) | $V_{INSIG-P(MAX)}$ (V_{P-P} AROUND V_{INREF}) | $V_{OUTDIFF(MAX)}$ ($V_{P-PDIFF}$) |
|---------------|---------------|---------------|------------------|--------------------|-------------------------|-------------------------|--|---|
| 2.7 | 0 | 1 | 1 | 1.35 | 2.250 | -0.650 | 1.80 | 1.80 |
| 2.7 | 0 | 2 | 1 | 1.35 | 1.850 | 0.350 | 1.00 | 2.00 |
| 2.7 | 0 | 5 | 1 | 1.35 | 1.610 | 0.950 | 0.52 | 2.60 |
| 2.7 | 0 | 10 | 1 | 1.35 | 1.530 | 1.150 | 0.36 | 3.60 |
| 5 | 0 | 1 | 2 | 2.5 | 6.500 | -1.500 | 8.00 | 8.00 |
| 5 | 0 | 2 | 2 | 2.5 | 4.500 | 0.500 | 4.00 | 8.00 |
| 5 | 0 | 5 | 2 | 2.5 | 3.300 | 1.700 | 1.60 | 8.00 |
| 5 | 0 | 10 | 2 | 2.5 | 2.900 | 2.100 | 0.80 | 8.00 |
| 5 | -5 | 1 | 2 | 0 | 6.000 | -6.000 | 12.00 | 12.00 |
| 5 | -5 | 2 | 2 | 0 | 3.000 | -3.000 | 6.00 | 12.00 |
| 5 | -5 | 5 | 2 | 0 | 1.200 | -1.200 | 2.40 | 12.00 |
| 5 | -5 | 10 | 2 | 0 | 0.600 | -0.600 | 1.20 | 12.00 |

APPLICATIONS INFORMATION

Table 1. Input Signal Limitations for Some Common Applications

Single Supply Ground Referenced Single-Ended Input Signal, V_{OCM} at Midsupply. (The V_{INSIG} Min and Max values listed account for both the input common mode limits and the output clipping)

| + V_S (V) | - V_S (V) | GAIN (V/V) | V_{OCM} (V) | V_{INREF} (V) | $V_{INSIG(MAX)}$ (V) | $V_{INSIG(MIN)}$ (V) | $V_{INSIGP-P(MAX)}$ (V_{P-P} AROUND V_{INREF}) | $V_{OUTDIFF(MAX)}$ ($V_{P-PDIFF}$) |
|----------------|----------------|---------------|------------------|--------------------|-------------------------|-------------------------|---|---|
| 2.7 | 0 | 1 | 1.35 | 0 | 2.700 | -2.700 | 5.40 | 5.40 |
| 2.7 | 0 | 2 | 1.35 | 0 | 1.350 | -1.350 | 2.70 | 5.40 |
| 2.7 | 0 | 5 | 1.35 | 0 | 0.540 | -0.540 | 1.08 | 5.40 |
| 2.7 | 0 | 10 | 1.35 | 0 | 0.270 | -0.270 | 0.54 | 5.40 |
| 5 | 0 | 1 | 2.5 | 0 | 5.000 | -5.000 | 10.00 | 10.00 |
| 5 | 0 | 2 | 2.5 | 0 | 2.500 | -2.500 | 5.00 | 10.00 |
| 5 | 0 | 5 | 2.5 | 0 | 1.000 | -1.000 | 2.00 | 10.00 |
| 5 | 0 | 10 | 2.5 | 0 | 0.500 | -0.500 | 1.00 | 10.00 |

Single Supply Ground Referenced Single-Ended Input Signal, V_{OCM} at Typical ADC Reference Levels. (The V_{INSIG} Min and Max values listed account for both the input common mode limits and the output clipping)

| + V_S (V) | - V_S (V) | GAIN (V/V) | V_{OCM} (V) | V_{INREF} (V) | $V_{INSIG(MAX)}$ (V) | $V_{INSIG(MIN)}$ (V) | $V_{INSIGP-P(MAX)}$ (V_{P-P} AROUND V_{INREF}) | $V_{OUTDIFF(MAX)}$ ($V_{P-PDIFF}$) |
|----------------|----------------|---------------|------------------|--------------------|-------------------------|-------------------------|---|---|
| 2.7 | 0 | 1 | 1 | 0 | 2.000 | -2.000 | 4.00 | 4.00 |
| 2.7 | 0 | 2 | 1 | 0 | 1.000 | -1.000 | 2.00 | 4.00 |
| 2.7 | 0 | 5 | 1 | 0 | 0.400 | -0.400 | 0.80 | 4.00 |
| 2.7 | 0 | 10 | 1 | 0 | 0.200 | -0.200 | 0.40 | 4.00 |
| 5 | 0 | 1 | 2 | 0 | 4.000 | -4.000 | 8.00 | 8.00 |
| 5 | 0 | 2 | 2 | 0 | 2.000 | -2.000 | 4.00 | 8.00 |
| 5 | 0 | 5 | 2 | 0 | 0.800 | -0.800 | 1.60 | 8.00 |
| 5 | 0 | 10 | 2 | 0 | 0.400 | -0.400 | 0.80 | 8.00 |

Fully Differential Amplifier Applications Circuit Analysis

All of the previous applications circuit discussions have assumed perfectly matched symmetrical feedback networks. To consider the effects of mismatched or asymmetrical feedback networks, the equations get a bit messier.

Figure 6 lists the basic gain equation for the differential output voltage in terms of $+V_{IN}$, $-V_{IN}$, V_{OSDIFF} , V_{OUTCM} and the feedback factors β_1 and β_2 . The feedback factors are simply the portion of the output that is fed back to the input summing junction by the R_{FB} - R_{IN} resistive voltage divider. β_1 and β_2 have the range of zero to one. The V_{OUTCM} term also includes its offset voltage, V_{OSCM} , and its gain mismatch term, K_{CM} . The K_{CM} term is determined by the matching of the on-chip R_{CMP} and R_{CMM} resistors in the common mode level servo (see Figure 2).

While mathematically correct, the basic signal equation does not immediately yield any intuitive feel for fully differential amplifier application operation. However, by nulling out specific terms, some basic observations and sensitivities come forth. Setting β_1 equal to β_2 , V_{OSDIFF} to zero and V_{OUTCM} to V_{OCM} gives the old gain equation from Figure 3. The ground referenced, single-ended input signal equation yields the interesting result that the driven side feedback factor (β_1) has a very different sensitivity than the grounded side (β_2). The CMRR is twice the feedback factor difference divided by the feedback factor sum. The differential output offset voltage has two terms. The first term is determined by the input offset term, V_{OSDIFF} , and the application's gain. Note that this term equates to the formula in Figure 3 when β_1 equals β_2 . The amount of signal level shifting and the feedback factor mismatch determines the second term. This term

APPLICATIONS INFORMATION

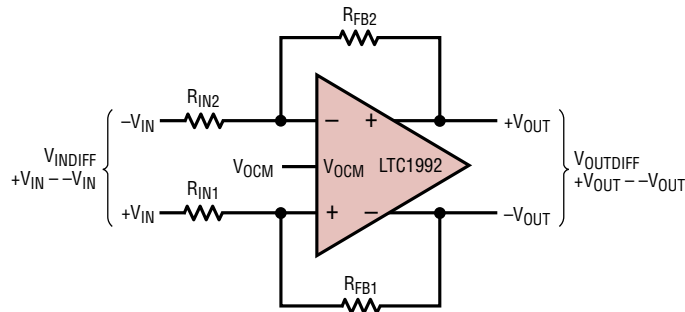

$$V_{OUTDIFF} = \frac{2[+V_{IN} \cdot (1 - \beta_1) - (-V_{IN}) \cdot (1 - \beta_2)] + 2V_{OSDIFF} + 2V_{OUTCM}(\beta_1 - \beta_2)}{\beta_1 + \beta_2}$$

WHERE:

$$\beta_1 = \frac{R_{IN1}}{R_{IN1} + R_{FB1}}; \beta_2 = \frac{R_{IN2}}{R_{IN2} + R_{FB2}}; V_{OSDIFF} = \text{AMPLIFIER INPUT REFERRED OFFSET VOLTAGE}$$

$$V_{OUTCM} = K_{CM} \cdot V_{OCM} + V_{OSCM}$$

$$0.999 < K_{CM} < 1.001$$

- FOR GROUND REFERENCED, SINGLE-ENDED INPUT SIGNAL, LET $+V_{IN} = V_{INSIG}$ AND $-V_{IN} = 0V$

$$V_{OUTDIFF} = \frac{2 \cdot V_{INSIG} \cdot (1 - \beta_1) + 2V_{OSDIFF} + 2V_{OUTCM}(\beta_1 - \beta_2)}{\beta_1 + \beta_2}$$

- COMMON MODE REJECTION: SET $+V_{IN} = -V_{IN} = V_{INCM}$, $V_{OSDIFF} = 0V$, $V_{OUTCM} = 0V$

$$CMRR = \frac{\Delta V_{INCM}}{\Delta V_{OUTDIFF}} = 2 \frac{\beta_1 + \beta_2}{\beta_2 - \beta_1}; \text{OUTPUT REFERRED}$$

- OUTPUT DC OFFSET VOLTAGE: SET $+V_{IN} = -V_{IN} = V_{INCM}$

$$V_{OSDIFFOUT} = V_{OSDIFF} \frac{2}{\beta_1 + \beta_2} + (V_{OUTCM} - V_{INCM}) 2 \frac{\beta_2 - \beta_1}{\beta_1 + \beta_2}$$

Figure 6. Basic Equations for Mismatched or Asymmetrical Feedback Applications Circuits

quantifies the undesired effect of signal level shifting discussed earlier in the Signal Level Shifting section.

Asymmetrical Feedback Application Circuits

The basic signal equation in Figure 6 also gives insight to another piece of intuition. The feedback factors may be deliberately set to different values. One interesting class of these application circuits sets one or both of the feedback factors to the extreme values of either zero or one. Figure 7 shows three such circuits.

At first these application circuits may look to be unstable or open loop. It is the common mode feedback loop that enables these circuits to function. While they are useful circuits, they have some shortcomings that must be considered. First, do to the severe feedback factor asymmetry, the V_{OCM} level influences the **differential** output voltage with about the same strength as the input signal. With this much gain in the V_{OCM} path, differential output offset and noise increase. The large V_{OCM} to $V_{OUTDIFF}$ gain also necessitates that these circuits are largely limited to

dual, split supply voltage applications with a ground referenced input signal and a grounded V_{OCM} pin.

The top application circuit in Figure 7 yields a high input impedance, precision gain of 2 block without any external resistors. The on-chip common mode feedback servo resistors determine the gain precision (better than 0.1 percent). By using the $-V_{OUT}$ output alone, this circuit is also useful to get a precision, single-ended output, high input impedance inverter. To intuitively understand this circuit, consider it as a standard op amp voltage follower (delivered through the signal gain servo) with a complementary output (delivered through the common mode level servo). As usual, the amplifier's input common mode range must not be exceeded. As with a standard op amp voltage follower, the common mode signal seen at the amplifier's input is the input signal itself. This condition limits the input signal swing, as well as the output signal swing, to be the input signal common mode range specification.

The middle circuit is largely the same as the first except that the noninverting amplifier path has gain. Note that

APPLICATIONS INFORMATION

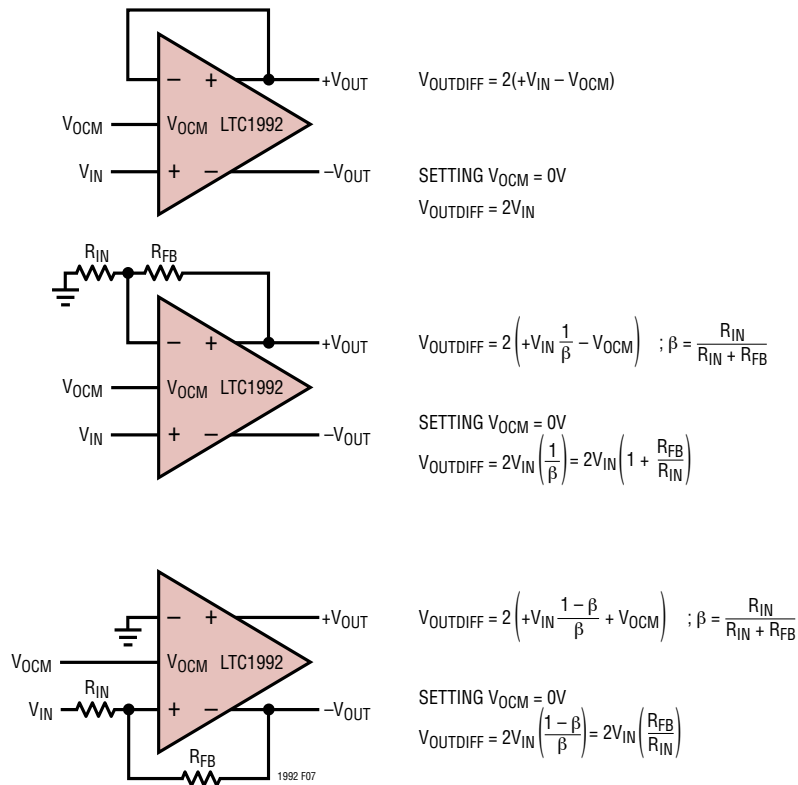

Figure 7. Asymmetrical Feedback Application Circuits (Most Suitable in Applications with Dual, Split Supplies (e.g., $\pm 5V$), Ground Referenced Single-Ended Input Signals and V_{OCM} Connected to Ground)

once the V_{OCM} voltage is set to zero, the gain formula is the same as a standard noninverting op amp circuit multiplied by two to account for the complementary output. Taking R_{FB} to zero (i.e., taking β to one) gives the same formula as the top circuit. As in the top circuit, this circuit is also useful as a single-ended output, high input impedance inverting gain block (this time with gain). The input common mode considerations are similar to the top circuit's, but are not nearly as constrained since there is now gain in the noninverting amplifier path. This circuit, with V_{OCM} at ground, also permits a rail-to-rail output swing in most applications.

The bottom circuit is another circuit that utilizes a standard op amp configuration with a complementary output. In this case, the standard op amp circuit has an inverting configuration. With V_{OCM} at zero volts, the gain formula is the same as a standard inverting op amp circuit multiplied by two to account for the complementary output. This circuit does not have any common mode level constraints as the inverting input voltage sets the input common mode level. This circuit also delivers rail-to-rail output voltage swing without any concerns.

TYPICAL APPLICATIONS

Interfacing a Bipolar, Ground Referenced, Single-Ended Signal to a Unipolar Single Supply, Differential Input ADC ($V_{IN} = 0V$ Gives a Digital Mid-Scale Code)

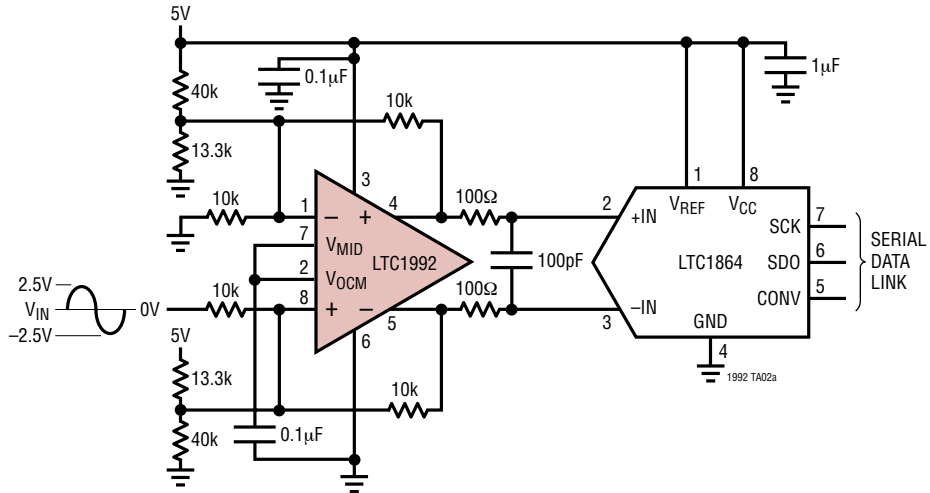

Compact, Unipolar Serial Data Conversion

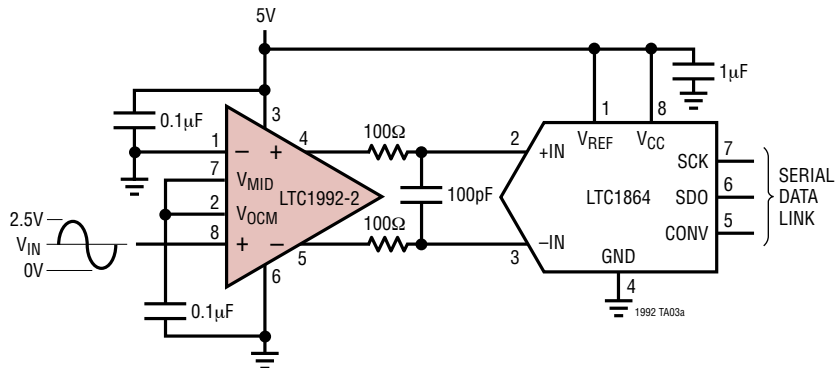

Zero Components, Single-Ended Adder/Subtractor

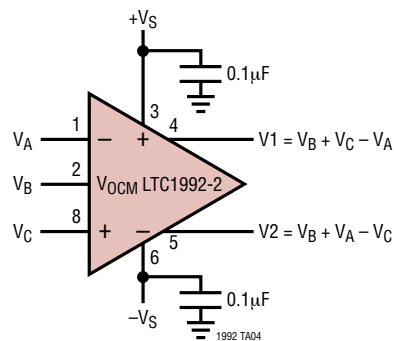

TYPICAL APPLICATIONS

Single-Ended to Differential Conversion Driving an ADC

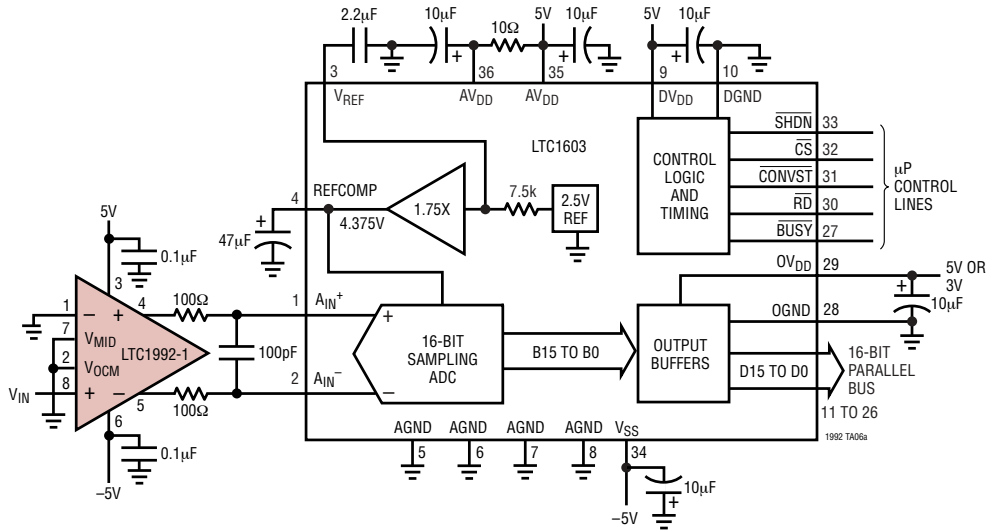

FFT of the Output Data

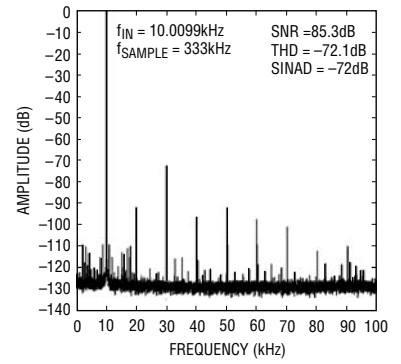

PACKAGE DESCRIPTION

MS8 Package 8-Lead Plastic MSOP (Reference LTC DWG # 05-08-1660)

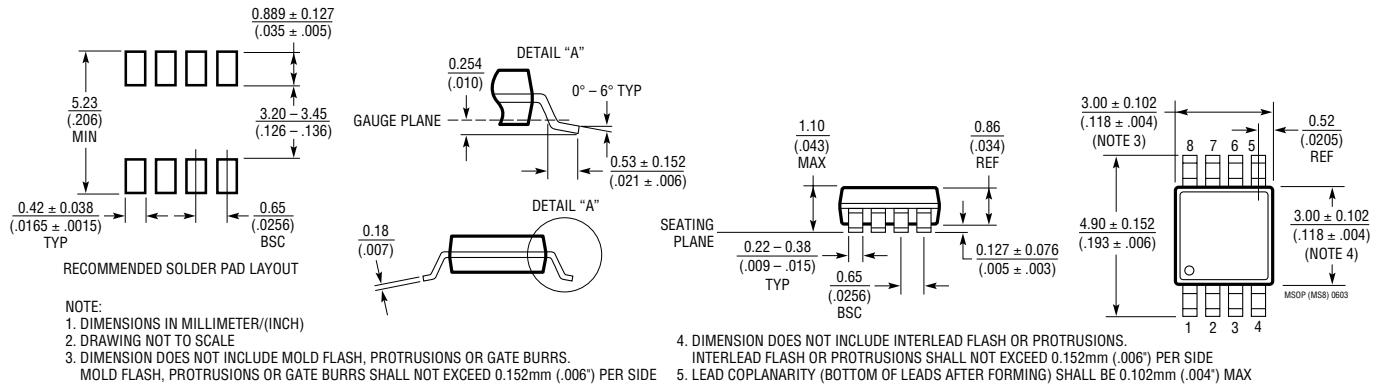

TYPICAL APPLICATION

Balanced Frequency Converter (Suitable for Frequencies up to 50kHz)

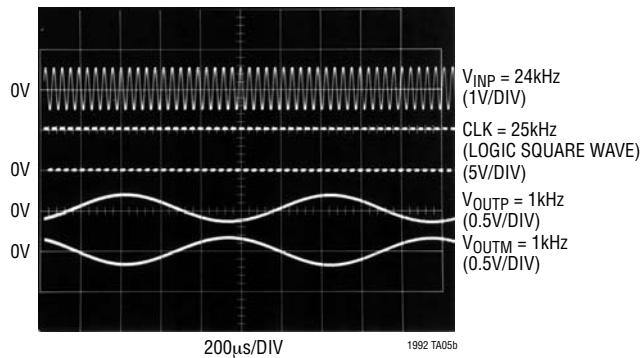
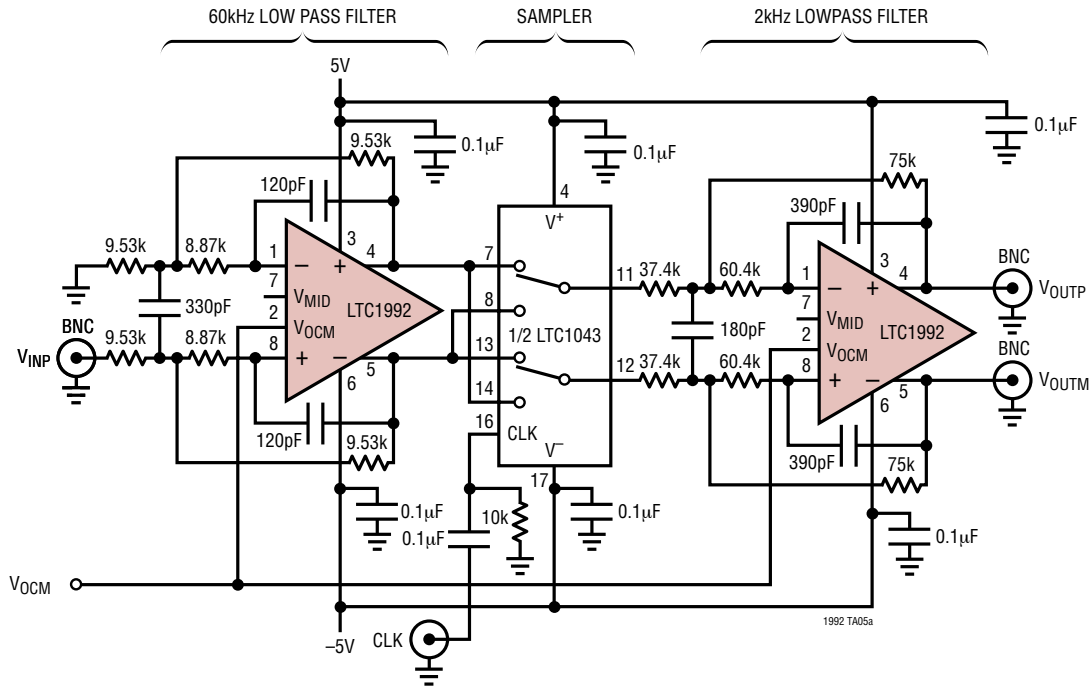

RELATED PARTS

| PART NUMBER | DESCRIPTION | COMMENTS |
|-------------|--|--|
| LT1167 | Precision Instrumentation Amplifier | Single Resistor Sets the Gain |
| LT1990 | High Voltage, Gain Selectable Difference Amplifier | $\pm 250\text{V}$ Common Mode, Micropower, Selectable Gain = 1, 10 |
| LT1991 | Precision Gain Selectable Difference Amplifier | Micropower, Pin Selectable Gain = -13 to 14 |
| LT1995 | High Speed Gain Selectable Difference Amplifier | 30MHz, 1000V/ μs , Pin Selectable Gain = -7 to 8 |
| LT6600-X | Differential In/Out Amplifier Lowpass Filter | Very Low Noise, Standard Differential Amplifier Pinout |