

300MHz to 7GHz RF Power Detector with Buffered Output in SC70 Package

FEATURES

- Temperature Compensated Internal Schottky Diode RF Detector
- Wide Input Frequency Range: 300MHz to 7GHz
- Wide Input Power Range: -32dBm to 12dBm
- Buffered Detector Output
- Wide V_{CC} Range of 2.7V to 6V
- Low Operating Current: 550 μ A
- Low Shutdown Current: <2 μ A
- SC70 Package

APPLICATIONS

- 802.11a, 802.11b, 802.11g, 802.15
- Multimode Mobile Phone Products
- Optical Data Links
- Wireless Data Modems
- Wireless and Cable Infrastructure
- RF Power Alarm
- Envelope Detector

DESCRIPTION

The LTC[®]5508 is an RF power detector for RF applications operating in the 300MHz to 7GHz range. A temperature compensated Schottky diode peak detector and buffer amplifier are combined in a small SC70 package. The supply voltage range is optimized for operation from a single lithium-ion cell or 3xNiMH.

The RF input voltage is peak detected using an on-chip Schottky diode. The detected voltage is buffered and supplied to the V_{OUT} pin. A power saving shutdown mode reduces supply current to less than 2 μ A.

The LTC5508 operates with input power levels from -32dBm to 12dBm.

 LTC and LT are registered trademarks of Linear Technology Corporation.

TYPICAL APPLICATION

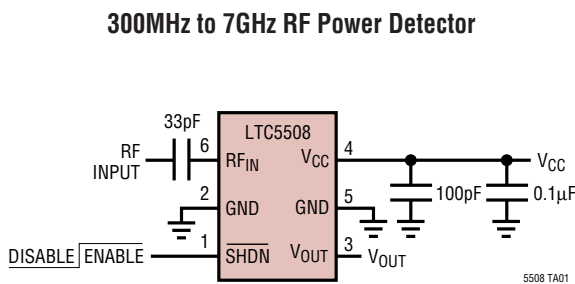

Output Voltage vs RF Input Power

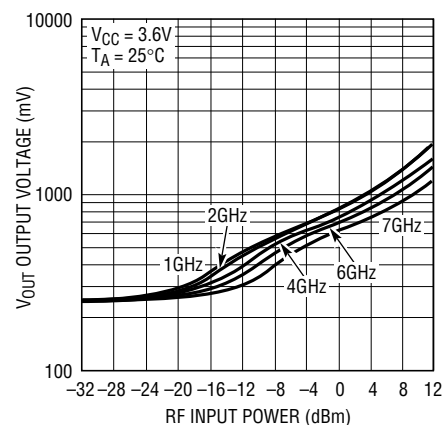

ABSOLUTE MAXIMUM RATINGS

(Note 1)

| | |
|---|------------------------------|
| V_{CC} , V_{OUT} to GND | -0.3V to 6.5V |
| RF_{IN} Voltage | ($V_{CC} \pm 1.3V$) to 7V |
| SHDN Voltage to GND | -0.3V to ($V_{CC} + 0.3V$) |
| I_{VOUT} | 5mA |
| Operating Temperature Range (Note 2) .. | -40°C to 85°C |
| Maximum Junction Temperature | 125°C |
| Storage Temperature Range | -65°C to 150°C |
| Lead Temperature (Soldering, 10 sec)..... | 300°C |

PACKAGE/ORDER INFORMATION

| | |
|--|-------------------|
| | ORDER PART NUMBER |
| | LTC5508ESC6 |
| | SC6 PART MARKING |
| | LAAD |

Consult LTC Marketing for parts specified with wider operating temperature ranges.

ELECTRICAL CHARACTERISTICS

The ● denotes the specifications which apply over the full operating temperature range, otherwise specifications are at $T_A = 25^\circ\text{C}$. $V_{CC} = 3.6V$, $\overline{\text{SHDN}} = V_{CC} = \text{HI}$, $\overline{\text{SHDN}} = 0V = \text{LO}$, RF Input Signal is Off, unless otherwise noted.

| PARAMETER | CONDITIONS | MIN | TYP | MAX | UNITS |
|---|--|-------|-------------|------|-------------------|
| V_{CC} Operating Voltage | | ● 2.7 | | 6 | V |
| I_{VCC} Shutdown Current | $\overline{\text{SHDN}} = \text{LO}$ | ● | | 2 | μA |
| I_{VCC} Operating Current | $\overline{\text{SHDN}} = \text{HI}$, $I_{VOUT} = 0\text{mA}$ | ● | 0.55 | 0.85 | mA |
| V_{OUT} V_{OL} (No RF Input) | $R_{LOAD} = 2k$, $\overline{\text{SHDN}} = \text{HI}$, Enabled $\overline{\text{SHDN}} = \text{LOW}$, Disabled | 150 | 250 1 | 400 | mV mV |
| V_{OUT} Output Current | $V_{OUT} = 1.75V$, $V_{CC} = 2.7V$, $\Delta V_{OUT} = 10\text{mV}$ | ● 1 | 2 | | mA |
| V_{OUT} Enable Time | $\overline{\text{SHDN}} = \text{HI}$, $C_{LOAD} = 33\text{pF}$, $R_{LOAD} = 2k$ | ● | 8 | 20 | μs |
| V_{OUT} Bandwidth | $C_{LOAD} = 33\text{pF}$, $R_{LOAD} = 2k$ (Note 4) | | 2 | | MHz |
| V_{OUT} Load Capacitance | (Note 6) | ● | | 33 | pF |
| V_{OUT} Slew Rate | $V_{RFIN} = 2V$ Step, $C_{LOAD} = 33\text{pF}$, $R_{LOAD} = 2k$ (Note 3) | | 5 | | V/ μs |
| V_{OUT} Noise | $V_{CC} = 3V$, Noise BW = 1.5MHz, 50 Ω RF Input Termination | | 2 | | mV _{P-P} |
| $\overline{\text{SHDN}}$ Voltage, Chip Disabled | $V_{CC} = 2.7V$ to 6V | ● | | 0.35 | V |
| $\overline{\text{SHDN}}$ Voltage, Chip Enabled | $V_{CC} = 2.7V$ to 6V | ● | 1.4 | | V |
| $\overline{\text{SHDN}}$ Input Current | $\overline{\text{SHDN}} = 3.6V$ | ● | 24 | 40 | μA |
| RF_{IN} Input Frequency Range | | | 300 to 7000 | | MHz |
| RF_{IN} Input Power Range | RF Frequency = 300MHz to 7GHz (Note 5, 6) $V_{CC} = 2.7V$ to 6V | | -32 to 12 | | dBm |
| RF_{IN} AC Input Resistance | $F = 1000\text{MHz}$, $P_{in} = -25\text{dBm}$ | | 150 | | Ω |
| RF_{IN} Input Shunt Capacitance | $F = 1000\text{MHz}$, $P_{in} = -25\text{dBm}$ | | 0.6 | | pF |

Note 1: Absolute Maximum Ratings are those values beyond which the life of a device may be impaired.

Note 2: Specifications over the -40°C to 85°C operating temperature range are assured by design, characterization and correlation with statistical process controls.

Note 3: The rise time at V_{OUT} is measured between 0.5V and 1.5V.

Note 4: Bandwidth is calculated using the 10% to 90% rise time equation: $BW = 0.35/\text{rise time}$.

Note 5: RF performance is tested at 1800MHz

Note 6: Guaranteed by design.

TYPICAL PERFORMANCE CHARACTERISTICS

Typical Detector Characteristics, 300MHz

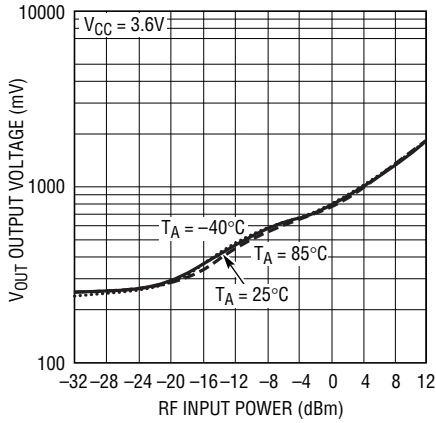

5508 G01

Typical Detector Characteristics, 1000MHz

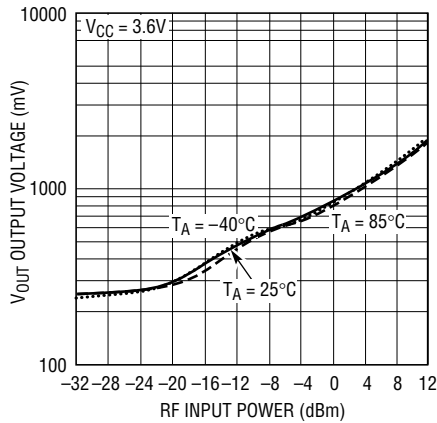

5508 G02

Typical Detector Characteristics, 2000MHz

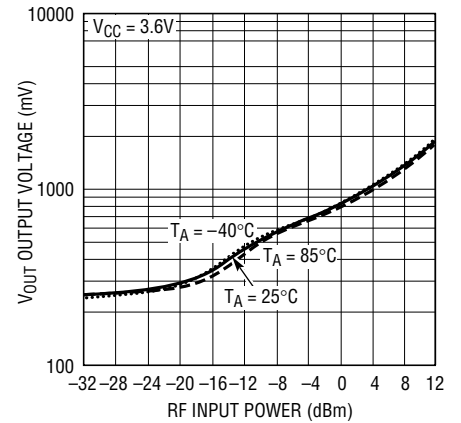

5508 G03

Typical Detector Characteristics, 3000MHz

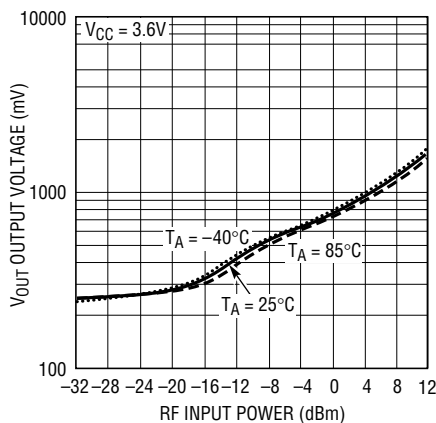

5508 G04

Typical Detector Characteristics, 4000MHz

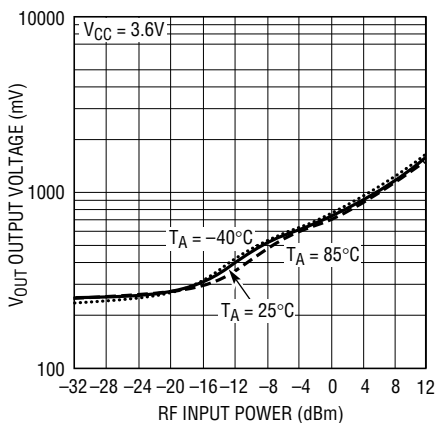

5508 G05

Typical Detector Characteristics, 5000MHz

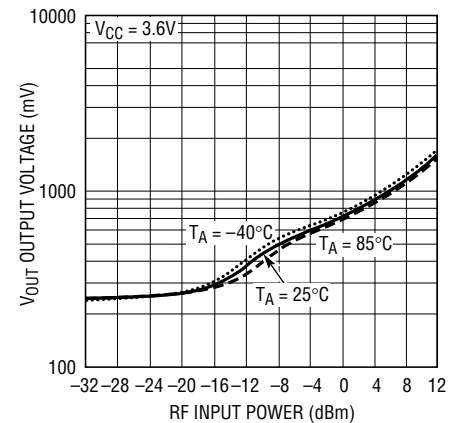

5508 G06

Typical Detector Characteristics, 6000MHz

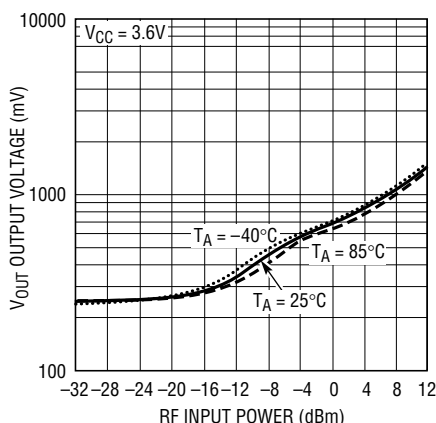

5508 G07

Typical Detector Characteristics, 7000MHz

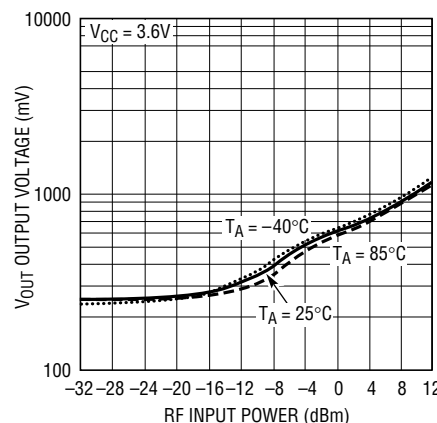

5508 G08

TYPICAL PERFORMANCE CHARACTERISTICS

V_{OUT} Slope vs RF Input Power at 300MHz

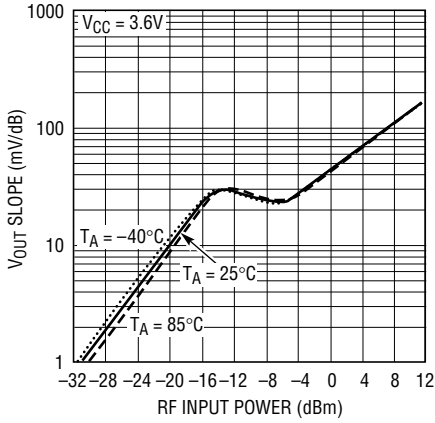

V_{OUT} Slope vs RF Input Power at 1000MHz

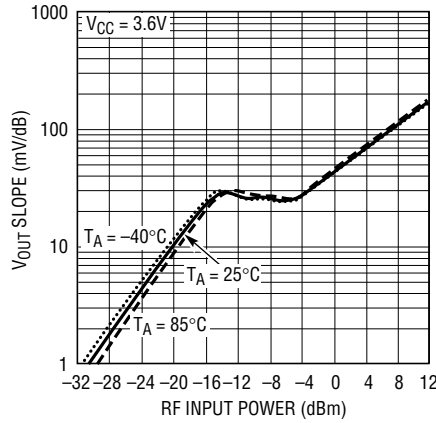

V_{OUT} Slope vs RF Input Power at 2000MHz

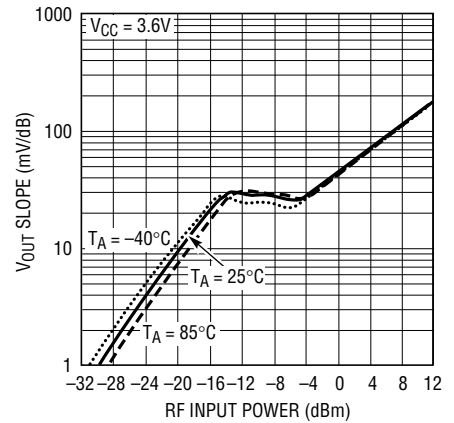

V_{OUT} Slope vs RF Input Power at 3000MHz

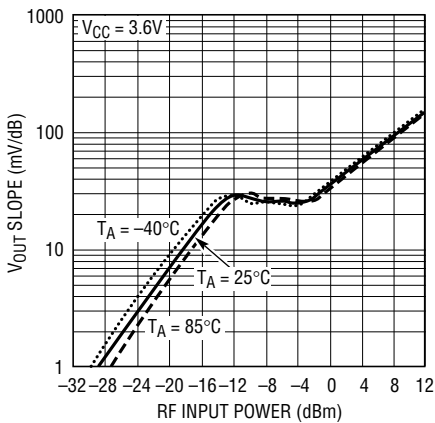

V_{OUT} Slope vs RF Input Power at 4000MHz

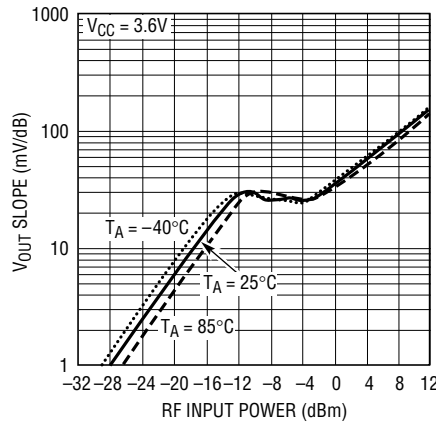

V_{OUT} Slope vs RF Input Power at 5000MHz

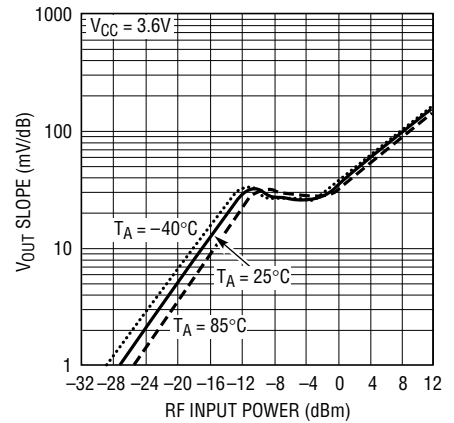

V_{OUT} Slope vs RF Input Power at 6000MHz

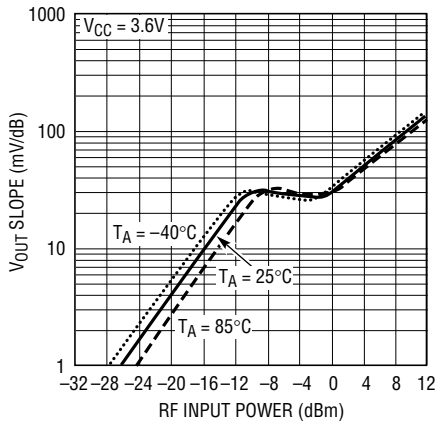

V_{OUT} Slope vs RF Input Power at 7000MHz

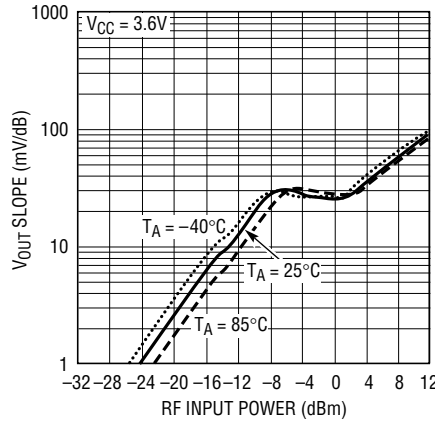

TYPICAL PERFORMANCE CHARACTERISTICS

RF_{IN} Input Impedance (P_{in} = 0dBm, V_{CC} = 3.6V, T_A = 25°C)

| FREQUENCY (GHz) | RESISTANCE (Ω) | REACTANCE (Ω) |
|-----------------|----------------|---------------|
| 1.000 | 129.136 | -86.960 |
| 1.375 | 100.771 | -92.142 |
| 1.750 | 73.844 | -81.141 |
| 2.125 | 60.159 | -68.796 |
| 2.500 | 50.135 | -58.139 |
| 2.875 | 43.042 | -48.927 |
| 3.250 | 37.570 | -41.033 |
| 3.625 | 33.924 | -33.346 |
| 4.000 | 30.923 | -26.405 |
| 4.375 | 28.793 | -20.012 |
| 4.750 | 26.992 | -14.080 |
| 5.125 | 25.717 | -8.323 |
| 5.500 | 24.920 | -3.228 |
| 5.875 | 24.318 | 2.177 |
| 6.250 | 24.549 | 7.535 |
| 6.625 | 25.273 | 12.197 |
| 7.000 | 26.337 | 16.503 |

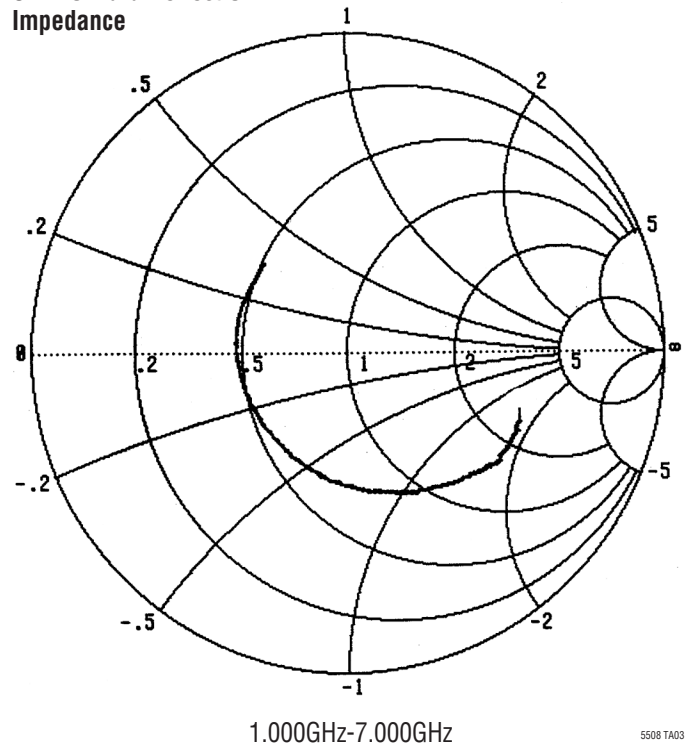
S11 Forward Reflection Impedance

RF_{IN} Input Impedance (P_{in} = -25dBm, V_{CC} = 3.6V, T_A = 25°C)

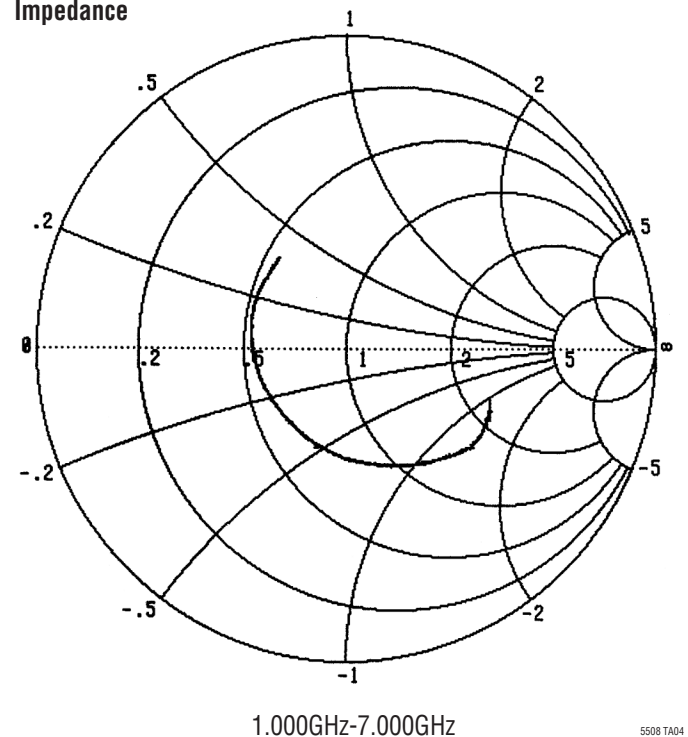
| FREQUENCY (GHz) | RESISTANCE (Ω) | REACTANCE (Ω) |
|-----------------|----------------|---------------|
| 1.000 | 114.531 | -63.267 |
| 1.375 | 95.061 | -71.669 |
| 1.750 | 71.491 | -64.607 |
| 2.125 | 59.563 | -54.798 |
| 2.500 | 51.714 | -46.844 |
| 2.875 | 44.940 | -39.753 |
| 3.250 | 39.708 | -32.738 |
| 3.625 | 36.151 | -26.385 |
| 4.000 | 33.227 | -20.478 |
| 4.375 | 31.108 | -15.107 |
| 4.750 | 29.514 | -9.941 |
| 5.125 | 27.899 | -4.793 |
| 5.500 | 27.047 | 0.266 |
| 5.875 | 26.627 | 5.250 |
| 6.250 | 26.760 | 10.267 |
| 6.625 | 27.619 | 14.616 |
| 7.000 | 28.241 | 18.523 |

S11 Forward Reflection Impedance

PIN FUNCTIONS

SHDN (Pin 1): Shutdown Input. A logic low on the SHDN pin places the part in shutdown mode. A logic high enables the part. SHDN has an internal 150k pull down resistor to ensure that the part is in shutdown when no input is applied.

GND (Pin 2, 5): Ground.

V_{OUT} (Pin 3): Detector Output.

V_{CC} (Pin 4): Power Supply Voltage, 2.7V to 6V. V_{CC} should be bypassed appropriately with ceramic capacitors.

RF_{IN} (Pin 6): RF Input Voltage. Referenced to V_{CC}. A coupling capacitor must be used to connect to the RF signal source. The frequency range is 300MHz to 7GHz. This pin has an internal 250Ω termination, an internal Schottky diode detector and a peak detector capacitor.

BLOCK DIAGRAM

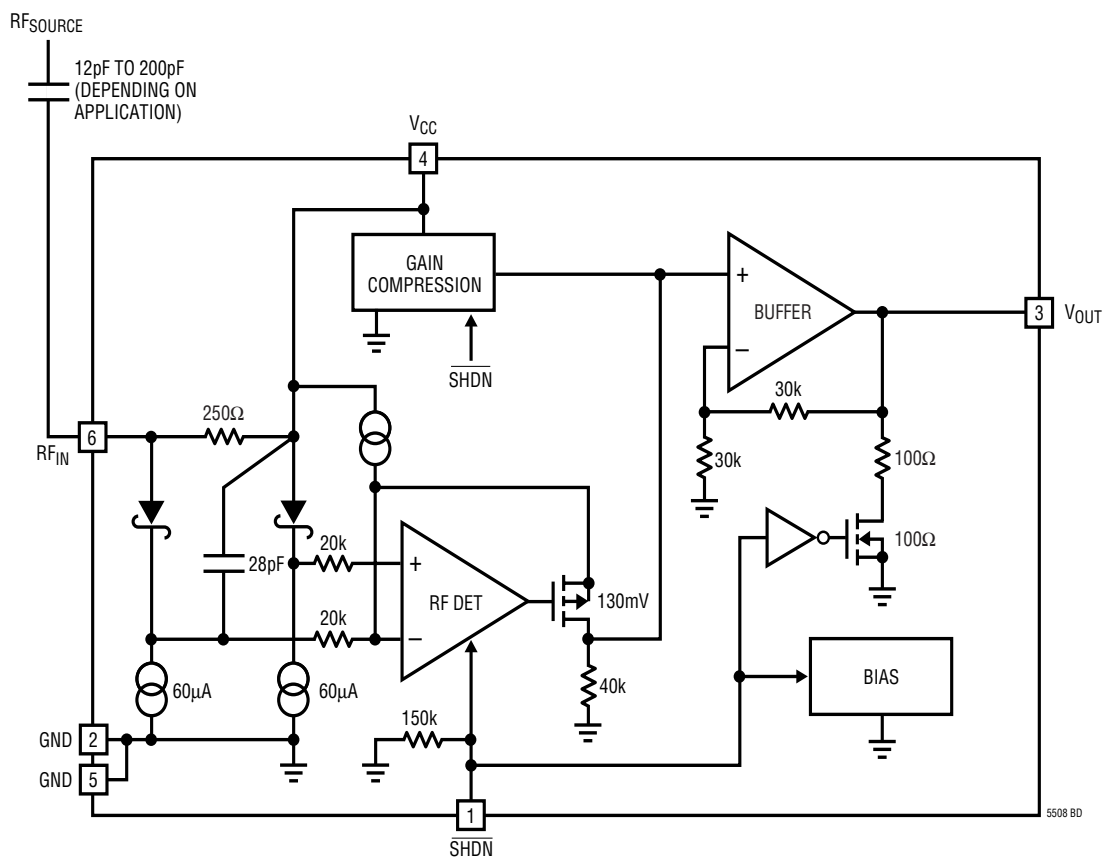

APPLICATIONS INFORMATION

Operation

The LTC5508 RF detector integrates several functions to provide RF power detection over frequencies ranging from 300MHz to 7GHz. These functions include an internally compensated buffer amplifier, an RF Schottky diode peak detector and level shift amplifier to convert the RF input signal to DC, a delay circuit to avoid voltage transients at V_{OUT} when coming out of shutdown and a gain compression circuit to extend the detector dynamic range.

Buffer Amplifier

The buffer amplifier has a gain of two and is capable of driving a 2mA load. The buffer amplifier typically has an output voltage range of 0.25V to 1.75V.

RF Detector

The internal RF Schottky diode peak detector and level shift amplifier converts the RF input signal to a low frequency signal. The detector demonstrates excellent efficiency and linearity over a wide range of input power. The Schottky detector is biased at about 60 μ A and drives a peak detector capacitor of 28pF.

Gain Compression

The gain compression circuit changes the feedback ratio as the RF peak-detected input voltage increases above

60mV. Below 60mV, the voltage gain from the peak detector to the buffer output is 4. Above 120mV, the voltage gain is reduced to 0.85. The compression expands the low power detector range due to higher gain.

Modes of Operation

| MODE | $\overline{\text{SHDN}}$ | OPERATION |
|----------|--------------------------|--------------|
| Shutdown | Low | Disabled |
| Enable | High | Power Detect |

Applications

The LTC5508 can be used as a self-standing signal strength measuring receiver for a wide range of input signals from -32dBm to 12dBm for frequencies from 300MHz to 7GHz.

The LTC5508 can be used as a demodulator for AM and ASK modulated signals with data rates up to 2MHz. Depending on specific application needs, the RSSI output can be split into two branches, providing AC-coupled data (or audio) output and DC-coupled, RSSI output for signal strength measurements and AGC.

The LTC5508 can be used for RF power detection and control. Refer to Application Note 91, "Low Cost Coupling Methods for RF Power Detectors Replace Directional Couplers."

Demo Board Schematic

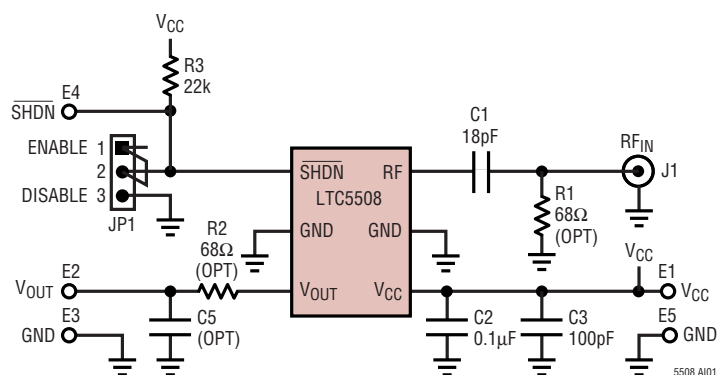

PACKAGE DESCRIPTION

SC6 Package
6-Lead Plastic SC70
 (Reference LTC DWG # 05-08-1638)

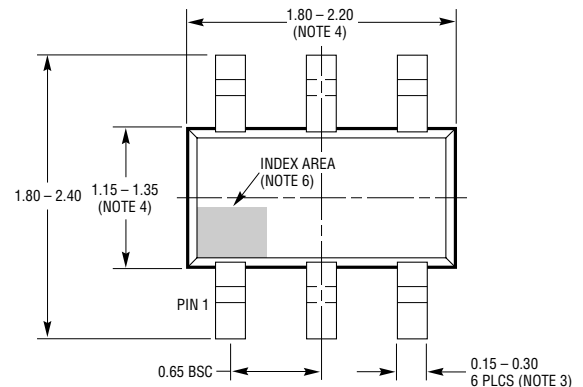
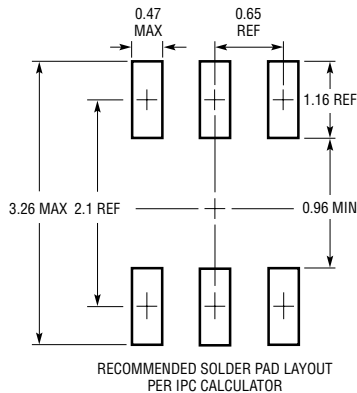

- NOTE:
1. DIMENSIONS ARE IN MILLIMETERS
 2. DRAWING NOT TO SCALE
 3. DIMENSIONS ARE INCLUSIVE OF PLATING
 4. DIMENSIONS ARE EXCLUSIVE OF MOLD FLASH AND METAL BURR
 5. MOLD FLASH SHALL NOT EXCEED 0.254mm
 6. DETAILS OF THE PIN 1 IDENTIFIER ARE OPTIONAL, BUT MUST BE LOCATED WITHIN THE INDEX AREA
 7. EIAJ PACKAGE REFERENCE IS EIAJ SC-70

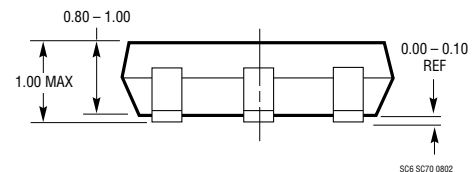
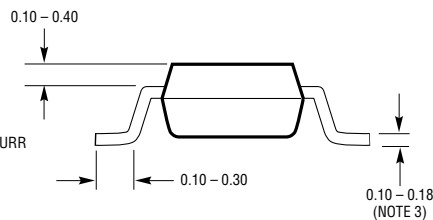

RELATED PARTS

| PART NUMBER | DESCRIPTION | COMMENTS |
|-----------------------------|--|---|
| RF Power Controllers | | |
| LTC1757A | RF Power Controller | Single/Dual Band GSM/DCS/GPRS Mobile Phones |
| LTC1758 | RF Power Controller | Single/Dual Band GSM/DCS/GPRS Mobile Phones |
| LTC1957 | RF Power Controller | Single/Dual Band GSM/DCS/GPRS Mobile Phones |
| LTC4400 | SOT-23 RF PA Controller | Single/Dual Band GSM/DCS/GPRS Phones, 45dB Dynamic Range, 450kHz Loop BW |
| LTC4401 | SOT-23 RF PA Controller | Single/Dual Band GSM/DCS/GPRS Phones, 45dB Dynamic Range, 250kHz Loop BW |
| LT5500 | 1.8GHz to 2.7GHz RF Front End | Dual LNA gain Setting +13.5dB/-14dB at 2.5GHz, Double-Balanced Mixer, $1.8V \leq V_{SUPPLY} \leq 5.25V$ |
| LT5502 | 400MHz Quadrature Demodulator with RSSI | 1.8V to 5.25V Supply, 70MHz to 400MHz IF, 84dB Limiting Gain, 90dB RSSI Range |
| LT5503 | 1.2GHz to 2.7GHz Direct IQ Modulator and Up Converting Mixer | 1.8V to 5.25V Supply, Four-Step RF Power Control, 120MHz Modulation Bandwidth |
| LT5504 | 800MHz to 2.7GHz RF Measuring Receiver | 80dB Dynamic Range, Temperature Compensated, 2.7V to 5.5V Supply |
| LTC5505 | 300MHz to 3.5GHz RF Power Detector | >40dB Dynamic Range, Temperature Compensated, 2.7V to 6V Supply |
| LT5506 | 500MHz Quadrature IF Demodulator with VGA | 1.8V to 5.25V Supply, 40MHz to 500MHz IF, -4dB to 57dB Linear Power Gain |
| LTC5507 | 100kHz to 1GHz RF Power Detector | 48dB Dynamic Range, Temperature Compensated, 2.7V to 6V Supply |
| LT5511 | High Signal Level Up Converting Mixer | RF Output to 3GHz, 17dBm IIP3, Integrated LO Buffer |
| LT5512 | High Signal Level Down Converting Mixer | DC-3GHz, 20dBm IIP3, Integrated LO Buffer |

5508fa