

# EC-3.1872M TR

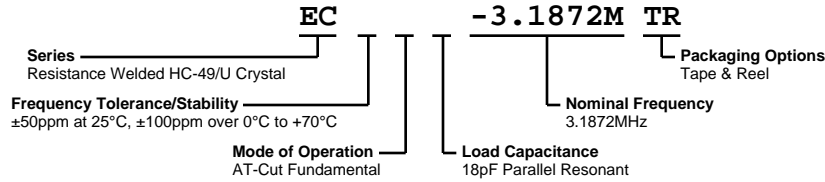

## ELECTRICAL SPECIFICATIONS

Nominal Frequency	3.1872MHz
Frequency Tolerance/Stability	±50ppm at 25°C, ±100ppm over 0°C to +70°C
Aging at 25°C	±5ppm/year Maximum
Load Capacitance	18pF Parallel Resonant
Shunt Capacitance (C0)	7pF Maximum
Equivalent Series Resistance	250 Ohms Maximum
Mode of Operation	AT-Cut Fundamental
Drive Level	2mWatts Maximum
Storage Temperature Range	-40°C to +85°C
Insulation Resistance	500 Megaohms Minimum at 100Vdc

## ENVIRONMENTAL & MECHANICAL SPECIFICATIONS

Fine Leak Test	MIL-STD-883, Method 1014, Condition A
Gross Leak Test	MIL-STD-883, Method 1014, Condition C
Lead Integrity	MIL-STD-883, Method 2004
Mechanical Shock	MIL-STD-202, Method 213, Condition C
Resistance to Soldering Heat	MIL-STD-202, Method 210
Resistance to Solvents	MIL-STD-202, Method 215
Solderability	MIL-STD-883, Method 2003
Temperature Cycling	MIL-STD-883, Method 1010
Vibration	MIL-STD-883, Method 2007, Condition A

## MECHANICAL DIMENSIONS (all dimensions in millimeters)



LINE	MARKING
1	ECLIPTEK
2	E3.1872M <i>E=Ecliptek Designator or Blank (No Marking)</i>
3	XX <i>XX=Ecliptek Manufacturing Code</i>

# EC-3.1872M TR



## Tape & Reel Dimensions

Quantity Per Reel: 1,000 Pieces

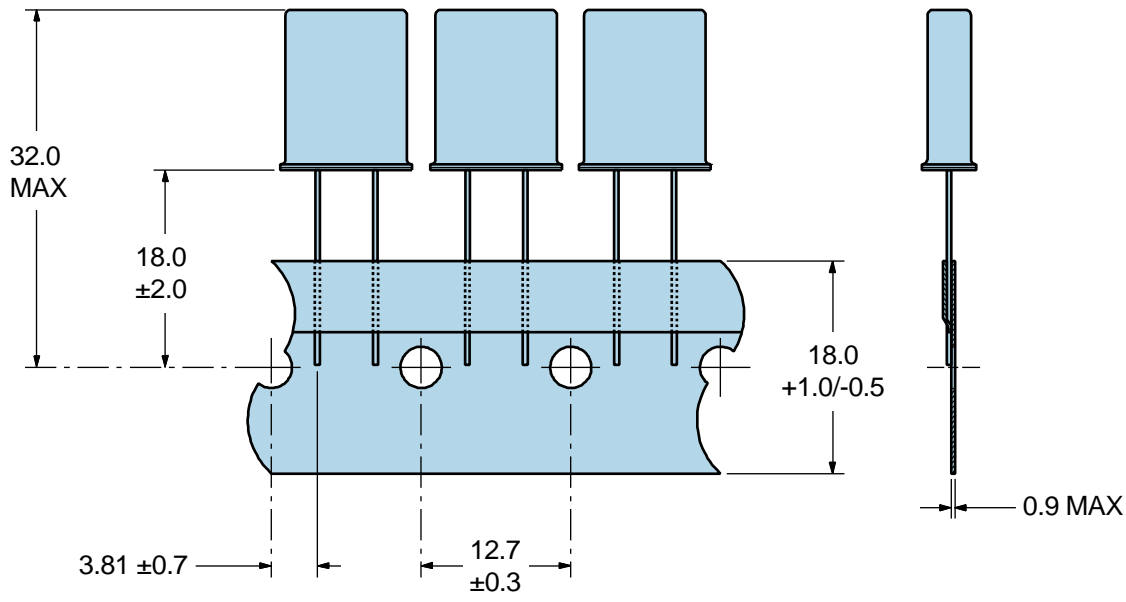

\*Compliant to EIA 468B

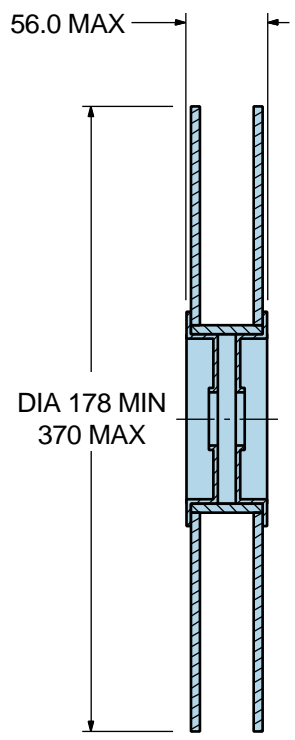
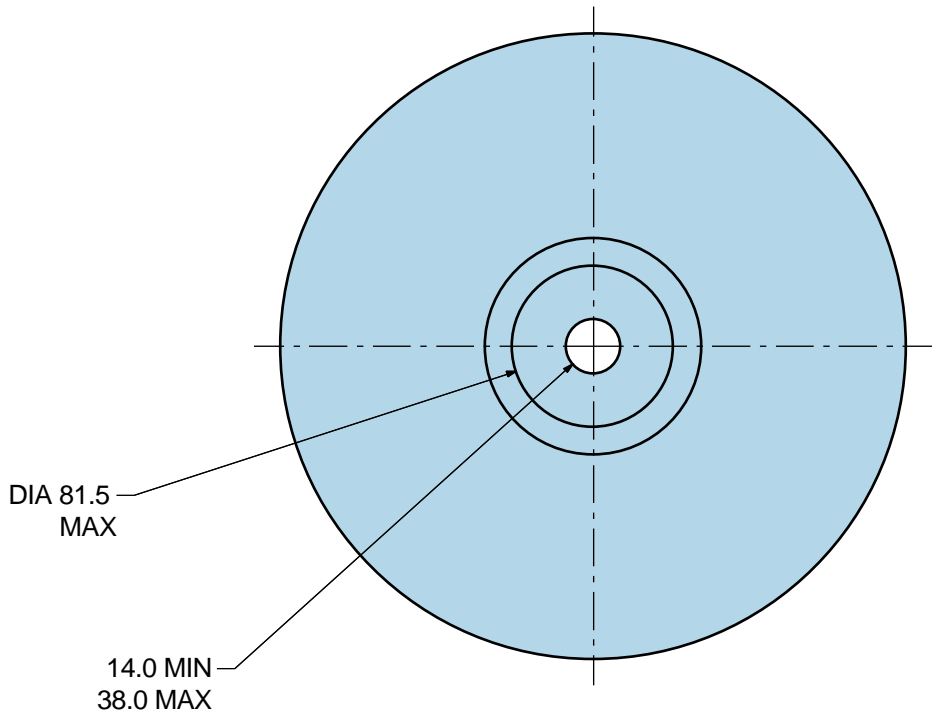

## Recommended Solder Reflow Methods



### High Temperature Solder Bath (Wave Solder)

<b><math>T_s</math> MAX to <math>T_L</math> (Ramp-up Rate)</b>	3°C/second Maximum
<b>Preheat</b>	
- Temperature Minimum ( $T_s$ MIN)	150°C
- Temperature Typical ( $T_s$ TYP)	175°C
- Temperature Maximum ( $T_s$ MAX)	200°C
- Time ( $t_s$ MIN)	60 - 180 Seconds
<b>Ramp-up Rate (<math>T_L</math> to <math>T_p</math>)</b>	3°C/second Maximum
<b>Time Maintained Above:</b>	
- Temperature ( $T_L$ )	217°C
- Time ( $t_L$ )	60 - 150 Seconds
<b>Peak Temperature (<math>T_p</math>)</b>	260°C Maximum for 10 Seconds Maximum
<b>Target Peak Temperature (<math>T_p</math> Target)</b>	250°C +0/-5°C
<b>Time within 5°C of actual peak (<math>t_p</math>)</b>	20 - 40 seconds
<b>Ramp-down Rate</b>	6°C/second Maximum
<b>Time 25°C to Peak Temperature (t)</b>	8 minutes Maximum
<b>Moisture Sensitivity Level</b>	Level 1

## Recommended Solder Reflow Methods



### Low Temperature Solder Bath (Wave Solder)

<b>T<sub>s</sub> MAX to T<sub>L</sub> (Ramp-up Rate)</b>	5°C/second Maximum
<b>Preheat</b>	
- Temperature Minimum (T <sub>s</sub> MIN)	N/A
- Temperature Typical (T <sub>s</sub> TYP)	150°C
- Temperature Maximum (T <sub>s</sub> MAX)	N/A
- Time (t <sub>s</sub> MIN)	30 - 60 Seconds
<b>Ramp-up Rate (T<sub>L</sub> to T<sub>P</sub>)</b>	5°C/second Maximum
<b>Time Maintained Above:</b>	
- Temperature (T <sub>L</sub> )	150°C
- Time (t <sub>L</sub> )	200 Seconds Maximum
<b>Peak Temperature (T<sub>P</sub>)</b>	245°C Maximum
<b>Target Peak Temperature (T<sub>P</sub> Target)</b>	245°C Maximum 1 Time / 235°C Maximum 2 Times
<b>Time within 5°C of actual peak (t<sub>p</sub>)</b>	5 seconds Maximum 1 Time / 15 seconds Maximum 2 Times
<b>Ramp-down Rate</b>	5°C/second Maximum
<b>Time 25°C to Peak Temperature (t)</b>	N/A
<b>Moisture Sensitivity Level</b>	Level 1

### Low Temperature Manual Soldering

185°C Maximum for 10 seconds Maximum, 2 times Maximum.

### High Temperature Manual Soldering

260°C Maximum for 5 seconds Maximum, 2 times Maximum.