

ECX-5450-17.664M-I2

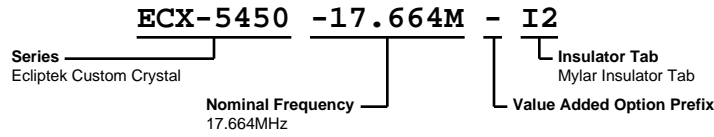

PLEASE NOTE: Due to the inherent proprietary nature of custom part numbers, certain parameters are intentionally excluded from this specification sheet.



ELECTRICAL SPECIFICATIONS

Nominal Frequency	17.664MHz
-------------------	-----------

ENVIRONMENTAL & MECHANICAL SPECIFICATIONS

Fine Leak Test	MIL-STD-883, Method 1014, Condition A
Gross Leak Test	MIL-STD-883, Method 1014, Condition C
Lead Integrity	MIL-STD-883, Method 2004
Mechanical Shock	MIL-STD-202, Method 213, Condition C
Resistance to Soldering Heat	MIL-STD-202, Method 210
Resistance to Solvents	MIL-STD-202, Method 215
Solderability	MIL-STD-883, Method 2003
Temperature Cycling	MIL-STD-883, Method 1010
Vibration	MIL-STD-883, Method 2007, Condition A

MECHANICAL DIMENSIONS (all dimensions in millimeters)



LINE	MARKING
1	ECX-5450
2	17.664M
3	XXYZZ XX=Ecliptek Manufacturing Designator Y=Last Digit Of Year ZZ=Week of Year

ECX-5450-17.664M-I2

Value Added Option - Mylar Insulator Tab

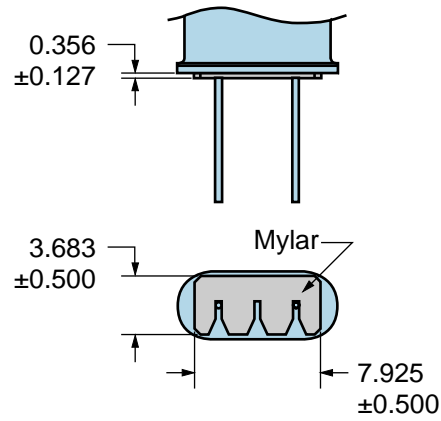

All dimensions are in millimeters

Recommended Solder Reflow Methods



High Temperature Solder Bath (Wave Solder)

T_S MAX to T_L (Ramp-up Rate) 3°C/second Maximum

Preheat

- Temperature Minimum (T_S MIN) 150°C
- Temperature Typical (T_S TYP) 175°C
- Temperature Maximum (T_S MAX) 200°C
- Time (t_s MIN) 60 - 180 Seconds

Ramp-up Rate (T_L to T_P) 3°C/second Maximum

Time Maintained Above:

- Temperature (T_L) 217°C
- Time (t_L) 60 - 150 Seconds

Peak Temperature (T_P) 260°C Maximum for 10 Seconds Maximum

Target Peak Temperature (T_P Target) 250°C +0/-5°C

Time within 5°C of actual peak (t_p) 20 - 40 seconds

Ramp-down Rate 6°C/second Maximum

Time 25°C to Peak Temperature (t) 8 minutes Maximum

Moisture Sensitivity Level Level 1

Recommended Solder Reflow Methods



Low Temperature Solder Bath (Wave Solder)

T_s MAX to T_L (Ramp-up Rate)	5°C/second Maximum
Preheat	
- Temperature Minimum (T _s MIN)	N/A
- Temperature Typical (T _s TYP)	150°C
- Temperature Maximum (T _s MAX)	N/A
- Time (t _s MIN)	30 - 60 Seconds
Ramp-up Rate (T_L to T_P)	5°C/second Maximum
Time Maintained Above:	
- Temperature (T _L)	150°C
- Time (t _L)	200 Seconds Maximum
Peak Temperature (T_P)	245°C Maximum
Target Peak Temperature (T_P Target)	245°C Maximum 1 Time / 235°C Maximum 2 Times
Time within 5°C of actual peak (t_p)	5 seconds Maximum 1 Time / 15 seconds Maximum 2 Times
Ramp-down Rate	5°C/second Maximum
Time 25°C to Peak Temperature (t)	N/A
Moisture Sensitivity Level	Level 1

Low Temperature Manual Soldering

185°C Maximum for 10 seconds Maximum, 2 times Maximum.

High Temperature Manual Soldering

260°C Maximum for 5 seconds Maximum, 2 times Maximum.