

EC2-11.000M TR

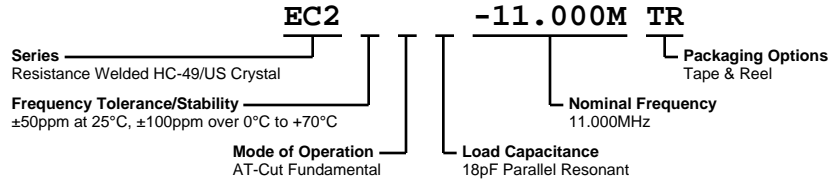

ELECTRICAL SPECIFICATIONS

Nominal Frequency	11.000MHz
Frequency Tolerance/Stability	±50ppm at 25°C, ±100ppm over 0°C to +70°C
Aging at 25°C	±5ppm/year Maximum
Load Capacitance	18pF Parallel Resonant
Shunt Capacitance (C0)	7pF Maximum
Equivalent Series Resistance	70 Ohms Maximum
Mode of Operation	AT-Cut Fundamental
Drive Level	1mWatt Maximum
Storage Temperature Range	-40°C to +85°C
Insulation Resistance	500 Megaohms Minimum at 100Vdc

ENVIRONMENTAL & MECHANICAL SPECIFICATIONS

Fine Leak Test	MIL-STD-883, Method 1014 Condition A
Gross Leak Test	MIL-STD-883, Method 1014 Condition C
Lead Integrity	MIL-STD-883, Method 2004
Mechanical Shock	MIL-STD-202, Method 213 Condition C
Resistance to Soldering Heat	MIL-STD-202, Method 210
Resistance to Solvents	MIL-STD-202, Method 215
Solderability	MIL-STD-883, Method 2003
Temperature Cycling	MIL-STD-883, Method 1010
Vibration	MIL-STD-883, Method 2007 Condition A

MECHANICAL DIMENSIONS (all dimensions in millimeters)

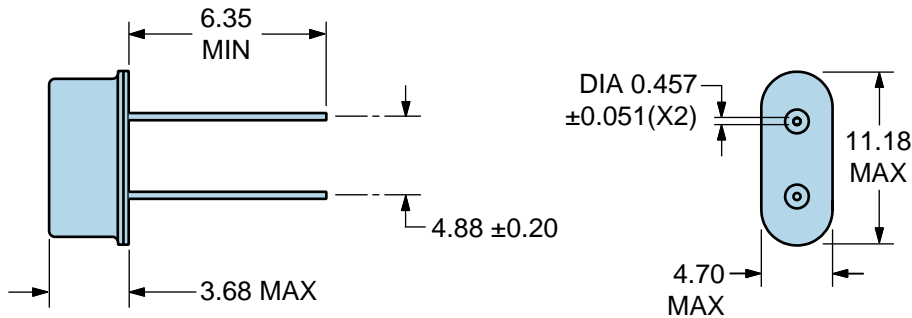

LINE	MARKING
1	E11.000M E=Ecliptek Designator M=Frequency Unit of Measure

EC2-11.000M TR

Tape & Reel Dimensions

Quantity Per Reel: 1,000 Pieces

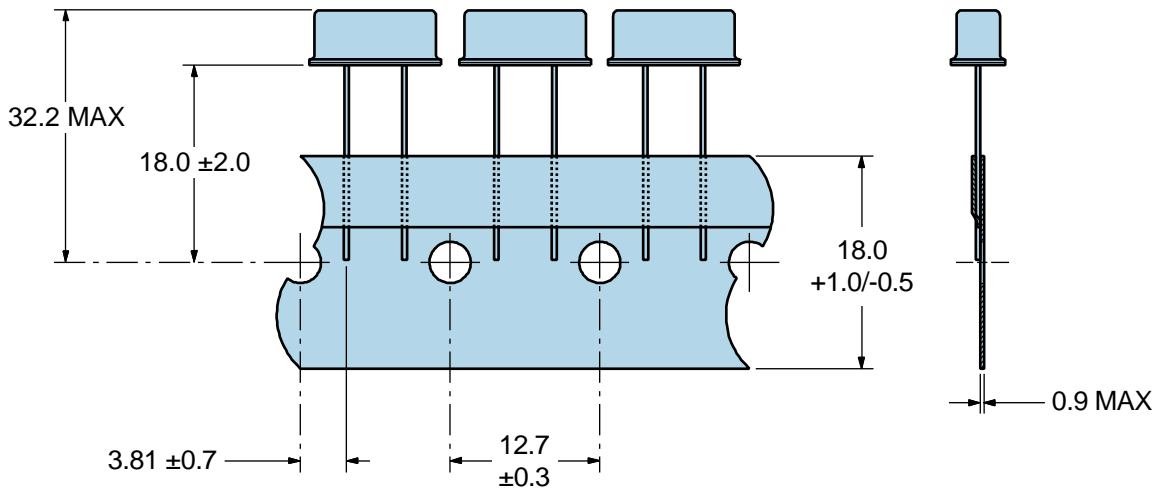

*Compliant to EIA 468B

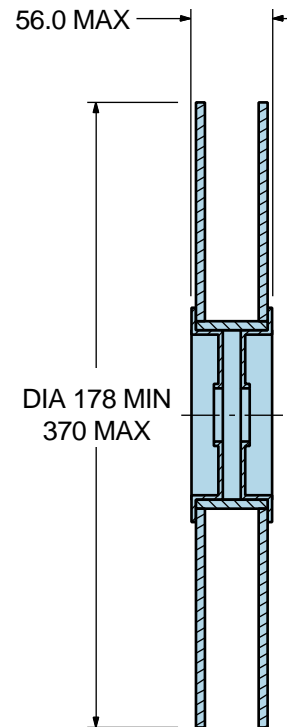
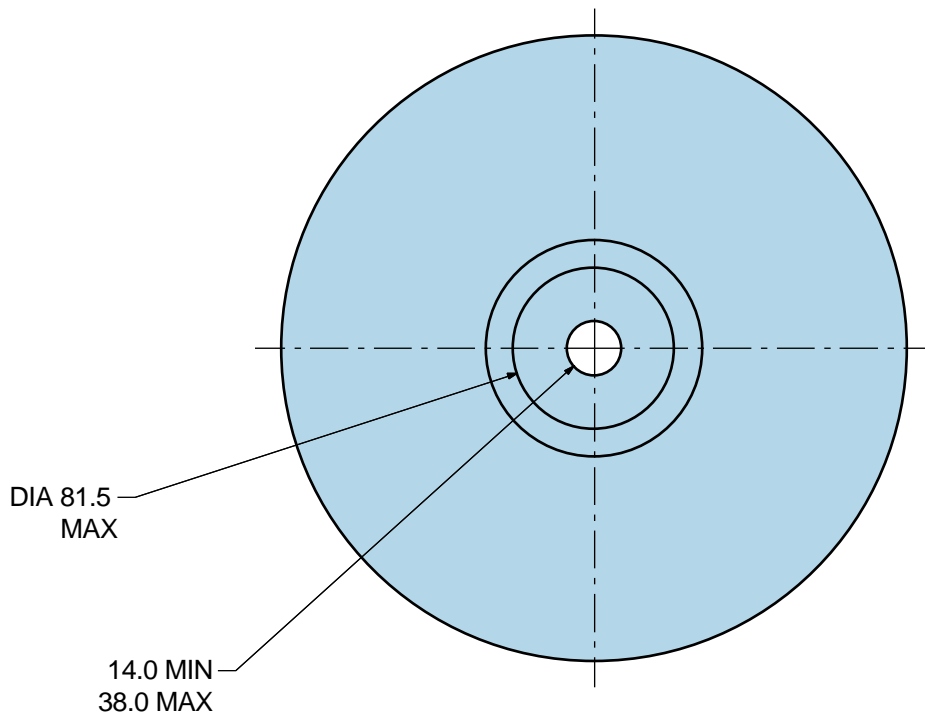

Recommended Solder Reflow Methods



High Temperature Solder Bath (Wave Solder)

T_s MAX to T_L (Ramp-up Rate)	3°C/second Maximum
Preheat	
- Temperature Minimum (T_s MIN)	150°C
- Temperature Typical (T_s TYP)	175°C
- Temperature Maximum (T_s MAX)	200°C
- Time (t_s MIN)	60 - 180 Seconds
Ramp-up Rate (T_L to T_p)	3°C/second Maximum
Time Maintained Above:	
- Temperature (T_L)	217°C
- Time (t_L)	60 - 150 Seconds
Peak Temperature (T_p)	260°C Maximum for 10 Seconds Maximum
Target Peak Temperature (T_p Target)	250°C +0/-5°C
Time within 5°C of actual peak (t_p)	20 - 40 seconds
Ramp-down Rate	6°C/second Maximum
Time 25°C to Peak Temperature (t)	8 minutes Maximum
Moisture Sensitivity Level	Level 1

Recommended Solder Reflow Methods



Low Temperature Solder Bath (Wave Solder)

T_s MAX to T_L (Ramp-up Rate)	5°C/second Maximum
Preheat	
- Temperature Minimum (T_s MIN)	N/A
- Temperature Typical (T_s TYP)	150°C
- Temperature Maximum (T_s MAX)	N/A
- Time (t_s MIN)	30 - 60 Seconds
Ramp-up Rate (T_L to T_p)	5°C/second Maximum
Time Maintained Above:	
- Temperature (T_L)	150°C
- Time (t_L)	200 Seconds Maximum
Peak Temperature (T_p)	245°C Maximum
Target Peak Temperature (T_p Target)	245°C Maximum 1 Time / 235°C Maximum 2 Times
Time within 5°C of actual peak (t_p)	5 seconds Maximum 1 Time / 15 seconds Maximum 2 Times
Ramp-down Rate	5°C/second Maximum
Time 25°C to Peak Temperature (t)	N/A
Moisture Sensitivity Level	Level 1

Low Temperature Manual Soldering

185°C Maximum for 10 seconds Maximum, 2 times Maximum.

High Temperature Manual Soldering

260°C Maximum for 5 seconds Maximum, 2 times Maximum.