

# EH2745ETTS-66.667M TR

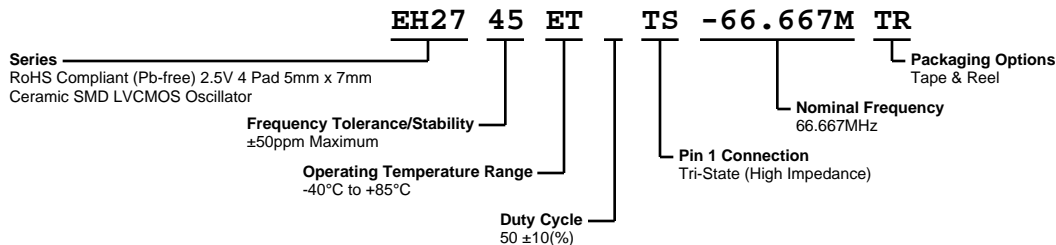

## ELECTRICAL SPECIFICATIONS

Nominal Frequency	66.667MHz
Frequency Tolerance/Stability	±50ppm Maximum (Inclusive of all conditions: Calibration Tolerance at 25°C, Frequency Stability over the Operating Temperature Range, Supply Voltage Change, Output Load Change, First Year Aging at 25°, 260°C Reflow, Shock, and Vibration)
Aging at 25°C	±5ppm/Year Maximum
Operating Temperature Range	-40°C to +85°C
Supply Voltage	2.5Vdc ±5%
Input Current	7mA Maximum (No Load)
Output Voltage Logic High (Voh)	90% of Vdd Minimum (IOH = -8mA)
Output Voltage Logic Low (Vol)	10% of Vdd Maximum (IOL = +8mA)
Rise/Fall Time	4nSec Maximum (Measured at 20% to 80% of waveform)
Duty Cycle	50 ±10(%) (Measured at 50% of waveform)
Load Drive Capability	15pF Maximum
Output Logic Type	CMOS
Pin 1 Connection	Tri-State (High Impedance)
Tri-State Input Voltage (Vih and Vil)	90% of Vdd Minimum or No Connect to Enable Output, 10% of Vdd Maximum to Disable Output (High Impedance)
Standby Current	10µA Maximum (Pin 1 = Ground)
Absolute Clock Jitter	±100pSec Maximum
Start Up Time	10mSec Maximum
Storage Temperature Range	-55°C to +125°C

## ENVIRONMENTAL & MECHANICAL SPECIFICATIONS

ESD Susceptibility	MIL-STD-883, Method 3015, Class 1, HBM: 1500V
Fine Leak Test	MIL-STD-883, Method 1014, Condition A
Flammability	UL94-V0
Gross Leak Test	MIL-STD-883, Method 1014, Condition C
Mechanical Shock	MIL-STD-883, Method 2002, Condition B
Moisture Resistance	MIL-STD-883, Method 1004
Moisture Sensitivity	J-STD-020, MSL 1
Resistance to Soldering Heat	MIL-STD-202, Method 210, Condition K
Resistance to Solvents	MIL-STD-202, Method 215
Solderability	MIL-STD-883, Method 2003
Temperature Cycling	MIL-STD-883, Method 1010, Condition B
Vibration	MIL-STD-883, Method 2007, Condition A

# EH2745ETTS-66.667M TR

## MECHANICAL DIMENSIONS (all dimensions in millimeters)



PIN	CONNECTION
1	Tri-State
2	Case Ground
3	Output
4	Supply Voltage

LINE	MARKING
1	<b>ECLIPTEK</b>
2	<b>66.667M</b>
3	<b>XXXXXX</b> XXXXXX=Ecliptek Manufacturing Identifier

## Suggested Solder Pad Layout

All Dimensions in Millimeters



All Tolerances are  $\pm 0.1$

# EH2745ETTS-66.667M TR

## OUTPUT WAVEFORM & TIMING DIAGRAM



### Test Circuit for CMOS Output



Note 1: An external 0.1µF low frequency tantalum bypass capacitor in parallel with a 0.01µF high frequency ceramic bypass capacitor close to the package ground and  $V_{DD}$  pin is required.

Note 2: A low capacitance (<12pF), 10X attenuation factor, high impedance (>10Mohms), and high bandwidth (>300MHz) passive probe is recommended.

Note 3: Capacitance value  $C_L$  includes sum of all probe and fixture capacitance.

# EH2745ETTS-66.667M TR

## Tape & Reel Dimensions

Quantity Per Reel: 1,000 units

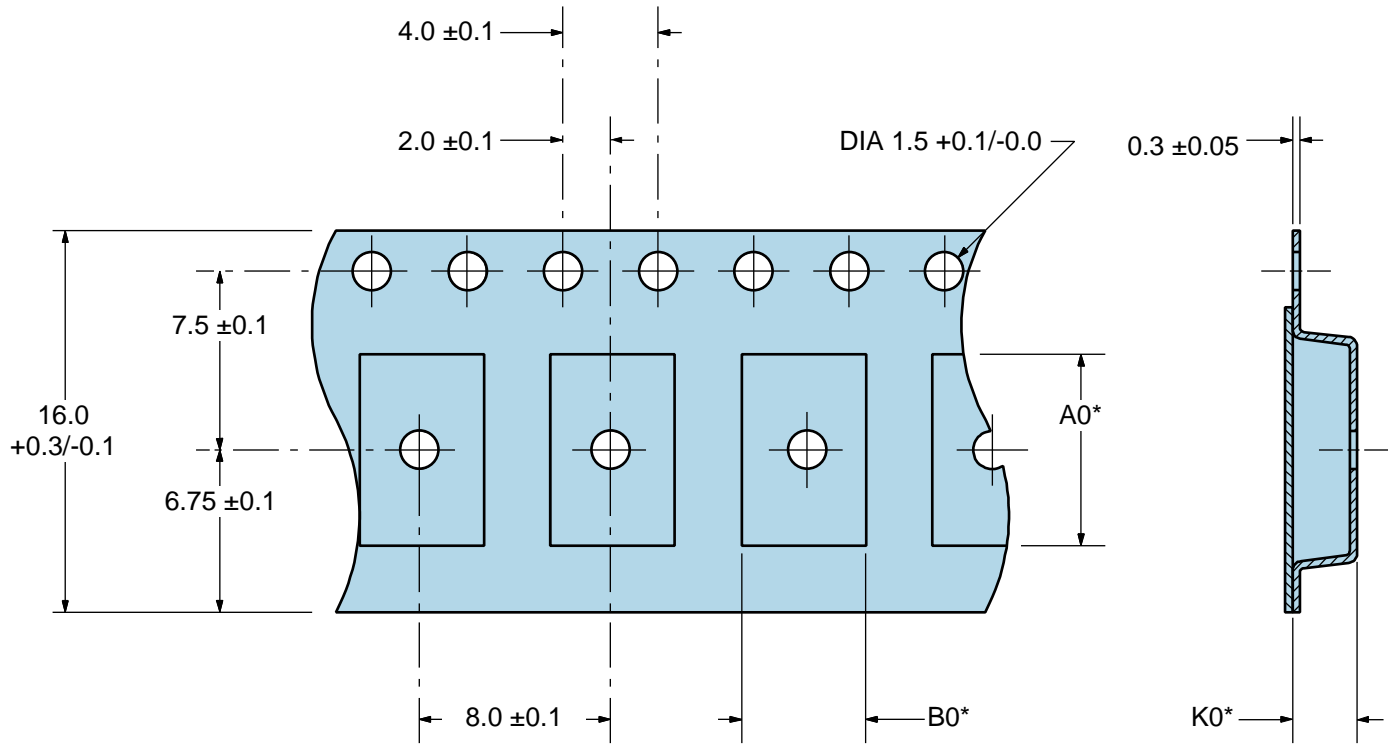

\*Compliant to EIA 481A

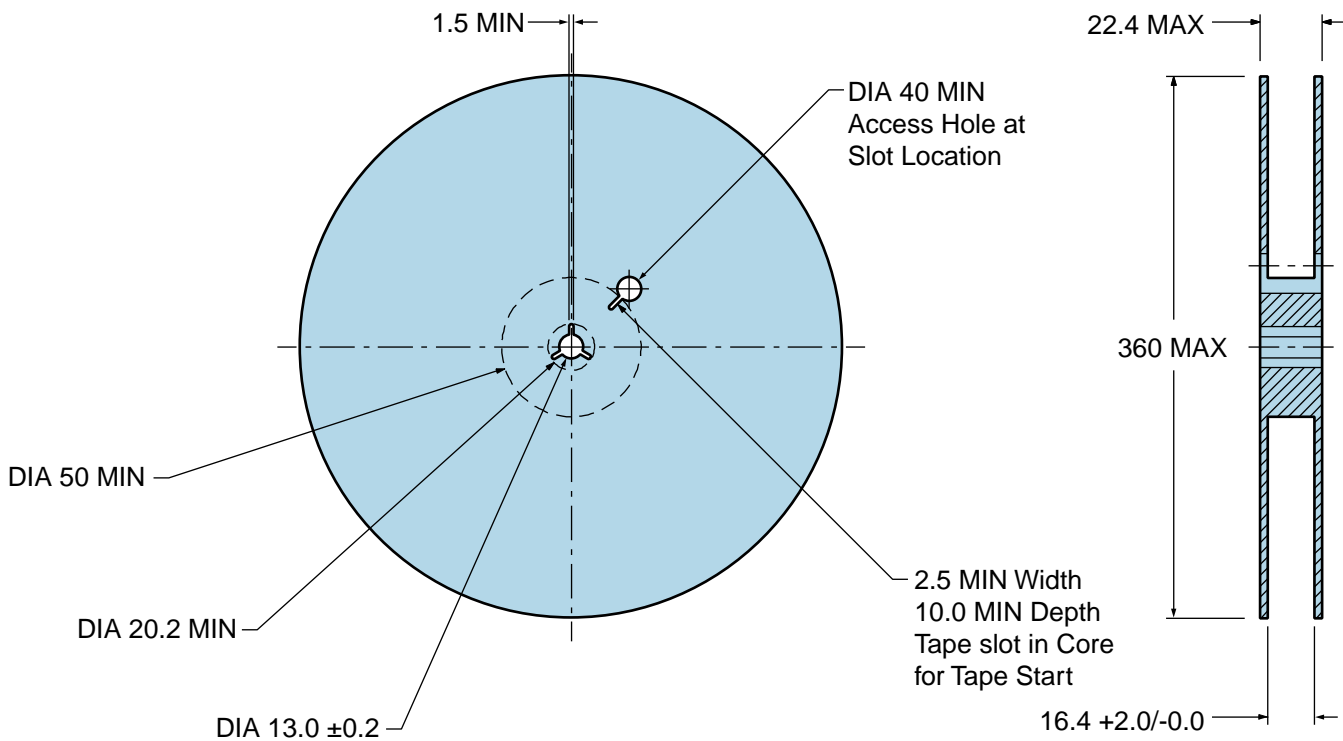

## Recommended Solder Reflow Methods



### High Temperature Infrared/Convection

<b><math>T_s</math> MAX to <math>T_L</math> (Ramp-up Rate)</b>	3°C/second Maximum
<b>Preheat</b>	
- Temperature Minimum ( $T_s$ MIN)	150°C
- Temperature Typical ( $T_s$ TYP)	175°C
- Temperature Maximum ( $T_s$ MAX)	200°C
- Time ( $t_s$ MIN)	60 - 180 Seconds
<b>Ramp-up Rate (<math>T_L</math> to <math>T_p</math>)</b>	3°C/second Maximum
<b>Time Maintained Above:</b>	
- Temperature ( $T_L$ )	217°C
- Time ( $t_L$ )	60 - 150 Seconds
<b>Peak Temperature (<math>T_p</math>)</b>	260°C Maximum for 10 Seconds Maximum
<b>Target Peak Temperature (<math>T_p</math> Target)</b>	250°C +0/-5°C
<b>Time within 5°C of actual peak (<math>t_p</math>)</b>	20 - 40 seconds
<b>Ramp-down Rate</b>	6°C/second Maximum
<b>Time 25°C to Peak Temperature (t)</b>	8 minutes Maximum
<b>Moisture Sensitivity Level</b>	Level 1
<b>Additional Notes</b>	Temperatures shown are applied to body of device.

## Recommended Solder Reflow Methods



### Low Temperature Infrared/Convection 240°C

<b><math>T_S</math> MAX to <math>T_L</math> (Ramp-up Rate)</b>	5°C/second Maximum
<b>Preheat</b>	
- Temperature Minimum ( $T_S$ MIN)	N/A
- Temperature Typical ( $T_S$ TYP)	150°C
- Temperature Maximum ( $T_S$ MAX)	N/A
- Time ( $t_S$ MIN)	60 - 120 Seconds
<b>Ramp-up Rate (<math>T_L</math> to <math>T_P</math>)</b>	5°C/second Maximum
<b>Time Maintained Above:</b>	
- Temperature ( $T_L$ )	150°C
- Time ( $t_L$ )	200 Seconds Maximum
<b>Peak Temperature (<math>T_P</math>)</b>	240°C Maximum
<b>Target Peak Temperature (<math>T_P</math> Target)</b>	240°C Maximum 1 Time / 230°C Maximum 2 Times
<b>Time within 5°C of actual peak (<math>t_p</math>)</b>	10 seconds Maximum 2 Times / 80 seconds Maximum 1 Time
<b>Ramp-down Rate</b>	5°C/second Maximum
<b>Time 25°C to Peak Temperature (t)</b>	N/A
<b>Moisture Sensitivity Level</b>	Level 1
<b>Additional Notes</b>	Temperatures shown are applied to body of device.

### Low Temperature Manual Soldering

185°C Maximum for 10 seconds Maximum, 2 times Maximum. (Temperatures shown are applied to body of device.)

### High Temperature Manual Soldering

260°C Maximum for 5 seconds Maximum, 2 times Maximum. (Temperatures shown are applied to body of device.)