

EH4625ETTS-14.7456M TR

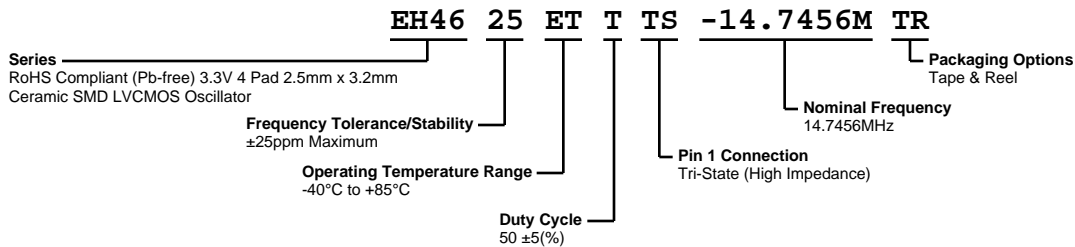

ELECTRICAL SPECIFICATIONS

Nominal Frequency	14.7456MHz
Frequency Tolerance/Stability	±25ppm Maximum (Inclusive of all conditions: Calibration Tolerance at 25°C, Frequency Stability over the Operating Temperature Range, Supply Voltage Change, Output Load Change, First Year Aging at 25°, 260°C Reflow, Shock, and Vibration)
Aging at 25°C	±5ppm/Year Maximum
Operating Temperature Range	-40°C to +85°C
Supply Voltage	3.3Vdc ±5%
Input Current	10mA Maximum (No Load)
Output Voltage Logic High (Voh)	90% of Vdd Minimum (IOH = -8mA)
Output Voltage Logic Low (Vol)	10% of Vdd Maximum (IOL = +8mA)
Rise/Fall Time	6nSec Maximum (Measured at 20% to 80% of waveform)
Duty Cycle	50 ±5(%) (Measured at 50% of waveform)
Output Logic Type	CMOS
Load Capacitance	30pF Maximum
Pin 1 Connection	Tri-State (High Impedance)
Tri-State Input Voltage (Vih and Vil)	90% of Vdd Minimum or No Connect to Enable Output, 10% of Vdd Maximum to Disable Output (High Impedance)
Standby Current	10µA Maximum (Pin 1 = Ground)
Absolute Clock Jitter	±100pSec Maximum
Start Up Time	10mSec Maximum
Storage Temperature Range	-55°C to +125°C

ENVIRONMENTAL & MECHANICAL SPECIFICATIONS

ESD Susceptibility	MIL-STD-883, Method 3015, Class 1, HBM: 1500Vdc
Fine Leak Test	MIL-STD-883, Method 1014, Condition A
Flammability	UL94-V0
Gross Leak Test	MIL-STD-883, Method 1014, Condition C
Mechanical Shock	MIL-STD-883, Method 2002, Condition B
Moisture Resistance	MIL-STD-883, Method 1004
Moisture Sensitivity	J-STD-020, MSL 1
Resistance to Soldering Heat	MIL-STD-202, Method 210, Condition K
Resistance to Solvents	MIL-STD-202, Method 215
Solderability	MIL-STD-883, Method 2003
Temperature Cycling	MIL-STD-883, Method 1010, Condition B
Vibration	MIL-STD-883, Method 2007, Condition A

EH4625ETTS-14.7456M TR

MECHANICAL DIMENSIONS (all dimensions in millimeters)

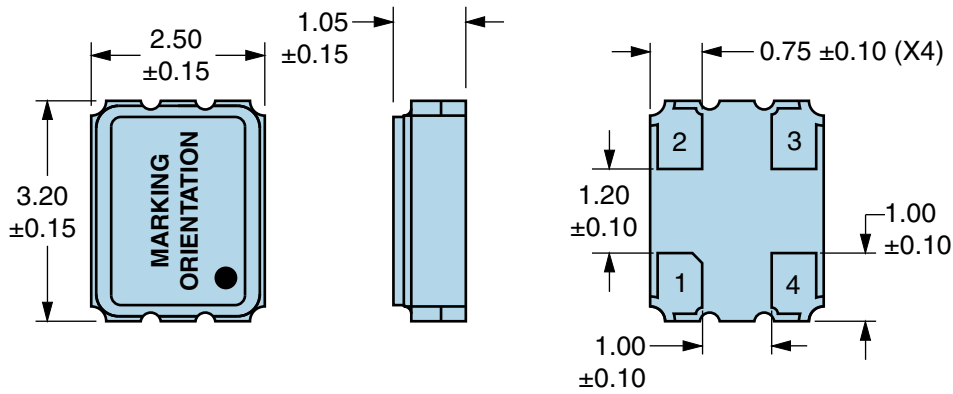

PIN	CONNECTION
1	Tri-State
2	Case Ground
3	Output
4	Supply Voltage

LINE	MARKING
1	EPO
2	XXXXX XXXXX=Ecliptek Manufacturing Identifier

Suggested Solder Pad Layout

All Dimensions in Millimeters



All Tolerances are ± 0.1

EH4625ETTS-14.7456M TR

OUTPUT WAVEFORM & TIMING DIAGRAM



Test Circuit for CMOS Output



Note 1: An external 0.1µF low frequency tantalum bypass capacitor in parallel with a 0.01µF high frequency ceramic bypass capacitor close to the package ground and V_{DD} pin is required.

Note 2: A low capacitance (<12pF), 10X attenuation factor, high impedance (>10Mohms), and high bandwidth (>300MHz) passive probe is recommended.

Note 3: Capacitance value C_L includes sum of all probe and fixture capacitance.

EH4625ETTS-14.7456M TR



Tape & Reel Dimensions

Quantity Per Reel: 1,000 units



*Compliant to EIA 481A



Recommended Solder Reflow Methods



High Temperature Infrared/Convection

T_s MAX to T_L (Ramp-up Rate)	3°C/second Maximum
Preheat	
- Temperature Minimum (T _s MIN)	150°C
- Temperature Typical (T _s TYP)	175°C
- Temperature Maximum (T _s MAX)	200°C
- Time (t _s MIN)	60 - 180 Seconds
Ramp-up Rate (T_L to T_p)	3°C/second Maximum
Time Maintained Above:	
- Temperature (T _L)	217°C
- Time (t _L)	60 - 150 Seconds
Peak Temperature (T_p)	260°C Maximum for 10 Seconds Maximum
Target Peak Temperature (T_p Target)	250°C +0/-5°C
Time within 5°C of actual peak (t_p)	20 - 40 seconds
Ramp-down Rate	6°C/second Maximum
Time 25°C to Peak Temperature (t)	8 minutes Maximum
Moisture Sensitivity Level	Level 1

Recommended Solder Reflow Methods



Low Temperature Infrared/Convection 240°C

T_s MAX to T_L (Ramp-up Rate)	5°C/second Maximum
Preheat	
- Temperature Minimum (T _s MIN)	N/A
- Temperature Typical (T _s TYP)	150°C
- Temperature Maximum (T _s MAX)	N/A
- Time (t _s MIN)	60 - 120 Seconds
Ramp-up Rate (T_L to T_p)	5°C/second Maximum
Time Maintained Above:	
- Temperature (T _L)	150°C
- Time (t _L)	200 Seconds Maximum
Peak Temperature (T_p)	240°C Maximum
Target Peak Temperature (T_p Target)	240°C Maximum 1 Time / 230°C Maximum 2 Times
Time within 5°C of actual peak (t_p)	10 seconds Maximum 2 Times / 80 seconds Maximum 1 Time
Ramp-down Rate	5°C/second Maximum
Time 25°C to Peak Temperature (t)	N/A
Moisture Sensitivity Level	Level 1

Low Temperature Manual Soldering

185°C Maximum for 10 seconds Maximum, 2 times Maximum.

High Temperature Manual Soldering

260°C Maximum for 5 seconds Maximum, 2 times Maximum.