

# Standard Heat Sinks

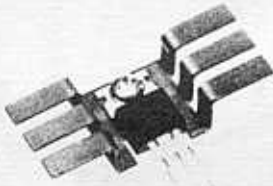

Low Profile

Material... 1100-H14 Aluminum  
Finish..... Black Anodize

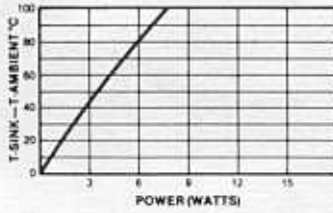

7-322

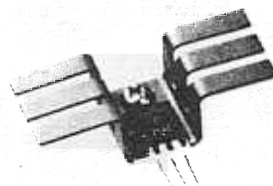
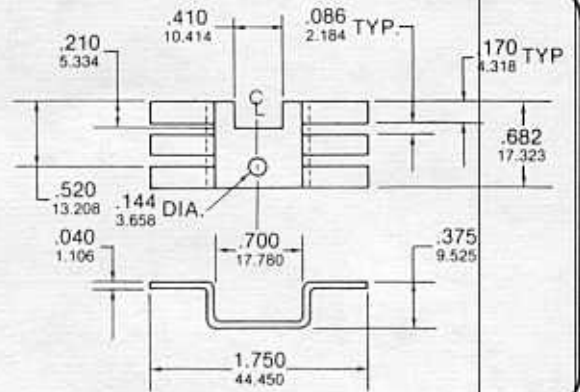

Can be mounted inside models 320, 321 or 322.

Material... 1100-H14 Aluminum  
Finish..... Black Anodize

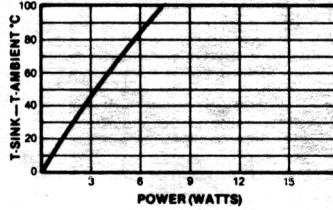

7-323

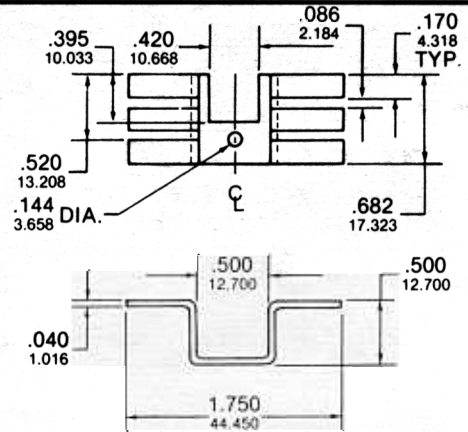

Material... 1100-H14 Aluminum  
Finish..... Black Anodize

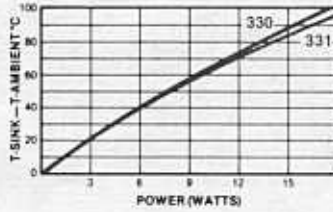

7-330

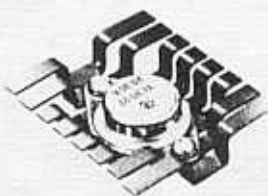
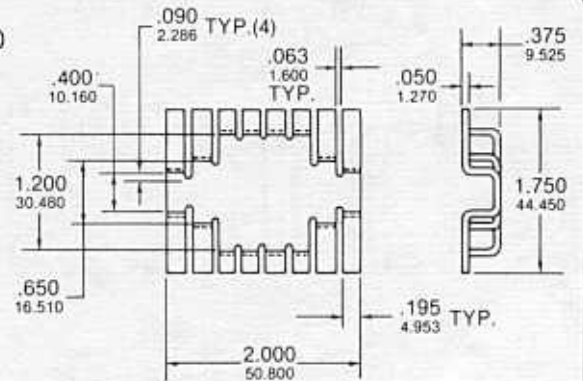

7-331

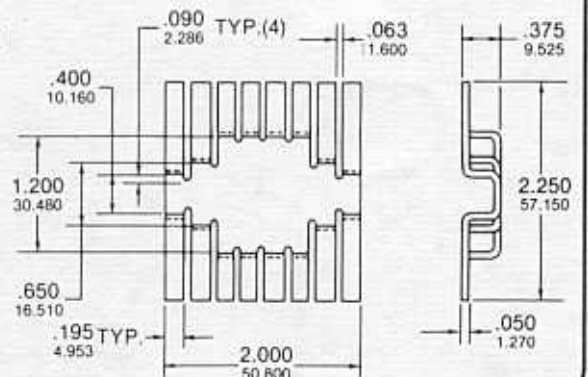
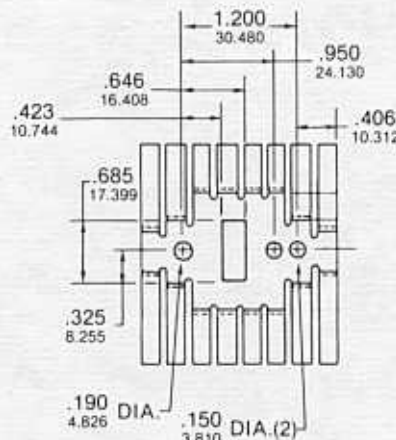

7-330 & 7-331

## Low Power