



## APPROVAL SHEET

Customer Name : \_\_\_\_\_  
Model Name.: LGA2011 narrow 1U HSK  
Delta Part No.: DHS-B10670-04  
Customer Part No.: \_\_\_\_\_  
Spec Issue Date : 2012/05/28  
Spec Revision : 00

PLEASE SEND ONE COPY OF THIS SPECIFICATION BACK AFTER YOU  
SIGNED APPROVAL FOR PRODUCTION PRE-ARRANGMENT.

Approved By: \_\_\_\_\_

Date: \_\_\_\_\_

Approval	Check	Designer
Charles.Chen	Charles.Chen	Skyler.Huang



# Delta Electronics Corp.

REV.	Description	Drawn	Checked	Approved	Issue Date
00	ISSUE SPEC	Skyler.Huang	Charles.Chen	Charles.Chen	2012/05/28
Description: SAMPLE REVISION CODE LIST					
Part No.					REV
DELTA MODEL : DHS-B10670-04		TOTAL <u>10</u> PAGE			00



# Delta Electronics Corp.

## CONTENTS

<b>Item</b>	<b>Element Description</b>	<b>Page</b>	<b>Note</b>
1	Specification	4	
2	Print	5	
3	Packing Plan	8	



# Delta Electronics Corp.

## 1. SPECIFICATION

### Characters

Item	Description
Scope	THIS SPECIFICATION DEFINES THE ELECTRICAL AND MECHANICAL CHARACTERISTICS OF THE FAN HEATSINK
Application	LGA2011 narrow 1U CPU
Specification	
a: Thermal Resistance	0.26 (°C/W) (REF.)
b: total weight	380 g (REF.)
c: clip force	30 Kgf (REF.)

### BOM

Item	Part Name	Material	Part NO.	Q'TY	Remark
1	BASE	C1100	3346875400	1 PCE	
2	FIN	AL1050	3346877800	1 PCE	
3	SPACER	POM	3244747000	4 PCE	
4	CAP	SUS	3462395200	4 PCE	
5	SPRING	SWP	3462028800	4 PCE	
6	SCREW	SUS	3105359900	4 PCE	
7	E-CLIP	SK7	3110264700	4 PCE	
8	GREASE	TC-1996	4021101500	0.25 g	
9					
10					
11					
12					
13					
14					
15					



**Delta Electronics Corp.**

## **2. PRINT**

**Assembly Drawing**

DRAWING:

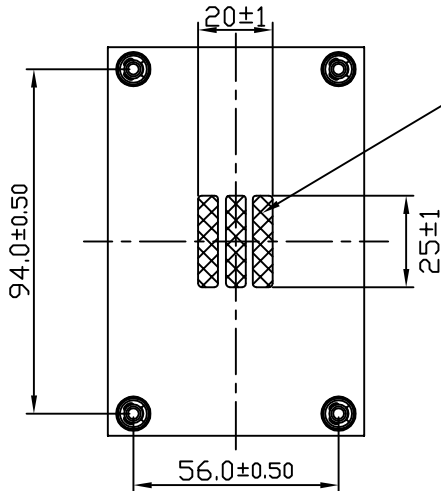
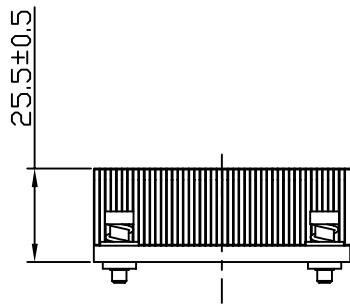
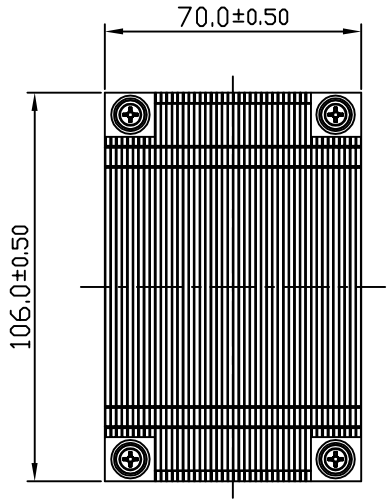

Dow Corning TC-1996 P/N:4021101500

\*STENCIL THICKNESS=0.20(TYP.) 0.22(MAX.)

TIM WEIGHT ON HSK MUST BE 250mg±30mg

UNIT: mm



台達電子工業股份有限公司  
DELTA ELECTRONICS, INC.

DELTA MODEL:  
DHS-B10670-04

Drawn:  
Skyler.Huang 05/28'12

THESE DRAWINGS AND SPECIFICATIONS ARE THE PROPERTY OF DELTA ELECTRONICS, INC. AND SHALL NOT BE REPRODUCED OR USED AS THE BASIS FOR THE MANUFACTURE OR SELL OF APPARATUSES OR DEVICES WITHOUT PERMISSION.

CUSTOMER NAME: ---  
CUSTOMER P/N: ---

DIMENSIONAL TOLERANCES		HOLES : ±0.05 ANGLES : ±0.5°							
( )	( )	( )	( )	( )	( )				
<30	±0.25	DECIMALS	UP~100	±0.2	250~300	±0.4	UP~600	±1.5	
>30~100	±0.35	X	±0.3	100~150	±0.25	300~350	±0.45	600~900	±2.4
>100~300	±0.5	X.X	±0.2	150~200	±0.3	350~400	±0.5	900~OVER	±3.1
ABOVE 300	±0.6	X.XX	±0.1	200~250	±0.35				



Description: PRODUCTION SPEC.  
(PHYSICAL DIMENSION)

A4  
SIZE

Part No. DHS-B10670-04-PD

REV.

SHEET 1 OF 1

ISSUE DATE:

--

SCALE 1:1 UNIT mm USED ON COOLER

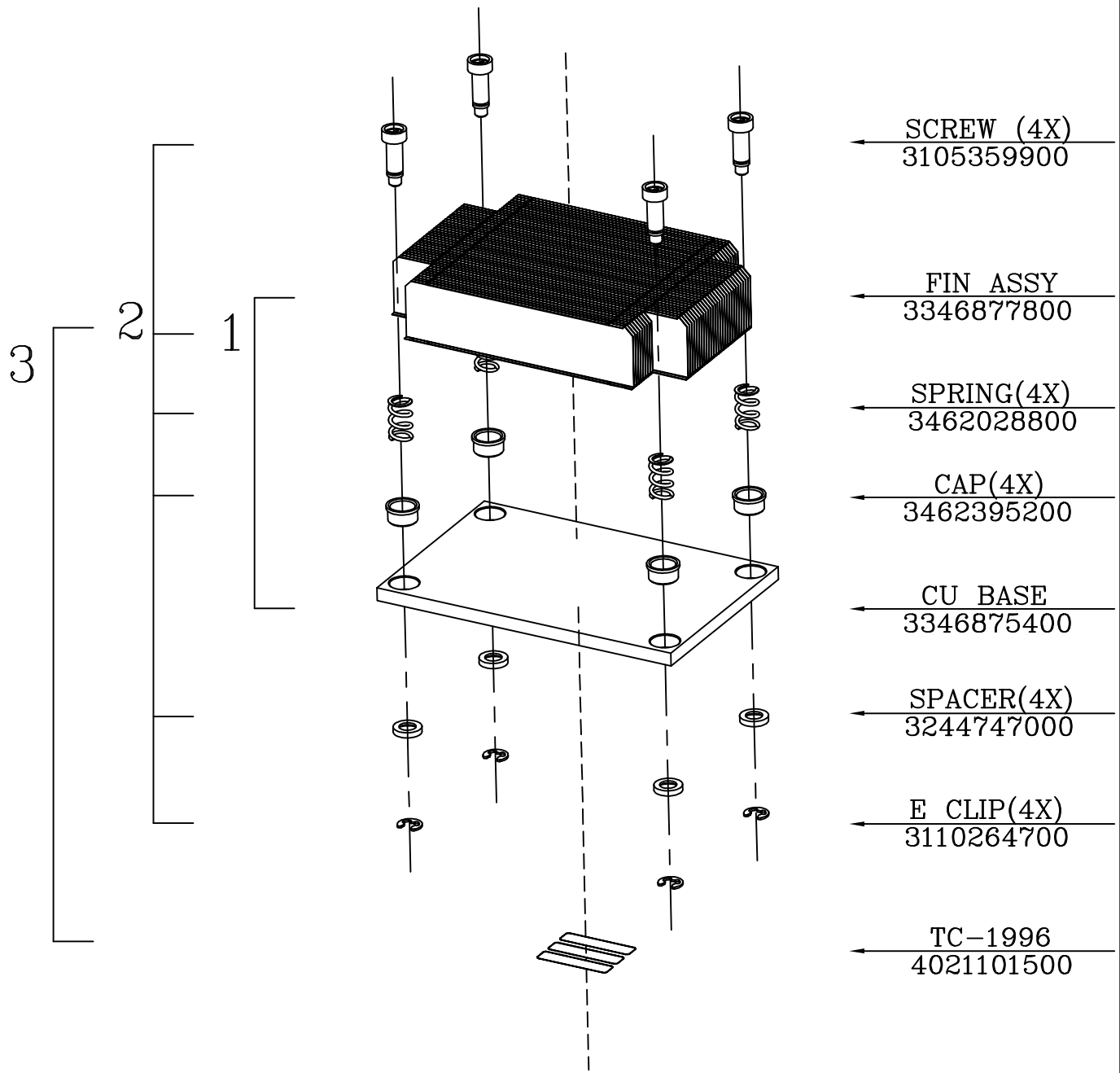

台達電子工業股份有限公司  
DELTA ELECTRONICS, INC.

DELTA MODEL:  
DHS-B10670-04

Drawn: Skyler.Huang  
05/28/12

THESE DRAWINGS AND SPECIFICATIONS ARE THE PROPERTY OF DELTA ELECTRONICS, INC. AND SHALL NOT BE REPRODUCED OR USED AS THE BASIS FOR THE MANUFACTURE OR SELL OF APPARATUSES OR DEVICES WITHOUT PERMISSION.

CUSTOMER NAME: -----

CUSTOMER P/N: -----

DIMENSIONAL TOLERANCES		HOLES : ±0.05 ANGLES : 48.5°						
( )	( )	( )	( )	( )	( )			
<30	±0.25	DECIMALS	UP~100	±0.2	250~300	±0.4	UP~600	±1.5
>30~100	±0.35	X	100~150	±0.25	300~350	±0.45	600~900	±2.4
>100~300	±0.5	X.X	150~200	±0.3	350~400	±0.5	900~OVER	±3.1
ABOVE 300	±0.6	X.XX	200~250	±0.35				



Description: PRODUCTION SPEC.  
(ASSEMBLY ORDER)

A4  
SIZE

Part No. DHS-B10670-04-AS

REV.

SHEET 1 OF 1 ISSUE DATE:

--

SCALE 1:1 UNIT mm USED ON COOLER



**Delta Electronics Corp.**

### **3. PACKING PLAN**

#### **Packing Specification**

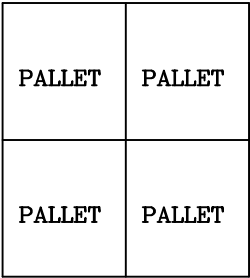
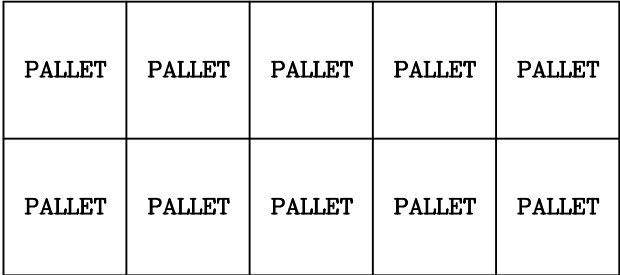

PART NO.	DHS-B10670-04				
BASIC DATA	QUANTITY/CARTON		24PCS (3 LAYERS/CARTON, 8 PCS/LAYER)		
	PRODUCTION NET WEIGHT		9.1 Kg (REF)		
	PRODUCTION GROSS WEIGHT		10.7 Kg (REF)		
20(ft)CONTAINER ILLUSTRATE	SIZE	5.889(L)*2.352(w)*2.386(H)m		PACKING QUANTITY	20 PALLETS/CONTAINER
	CONTAINER	STEEL			
CONTAINER FORM					 <p>FRONT VIEW</p>
CONTAINER LOADING MATHOD					
 <p>TOP VIEW</p>					←

PALLET LOADING ILLUSTRATE	SIZE	120(L)*100(w)*13.5(H)cm	PACKING QUANTITY	40 CARTONS/PALLET
	PALLET	PAPER		

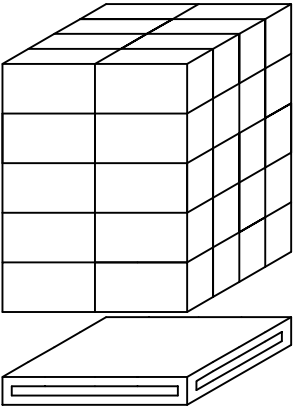
PALLET ILLUSTRATE		PALLET LOADING MATHOD		
				



台達電子工業股份有限公司  
DELTA ELECTRONICS, INC.

DELTA MODEL:  
DHS-B10670-04

Drawn:  
Skyler 05/28'12

THESE DRAWINGS AND SPECIFICATIONS ARE THE PROPERTY OF DELTA ELECTRONICS, INC. AND SHALL NOT BE REPRODUCED OR USED AS THE BASIS FOR THE MANUFACTURE OR SELL OF APPARATUSES OR DEVICES WITHOUT PERMISSION.

CUSTOMER NAME: -----  
CUSTOMER P/N: -----

DIMENSIONAL TOLERANCES		HOLES : ±0.05 ANGLES : ±0.5°	
( )	( )	( )	( )
<30	±0.25	DECIMALS	UP~100 ±0.2 250~300 ±0.4 UP~600 ±1.5
>30~100	±0.35	X ±0.3	100~150 ±0.25 300~350 ±0.45 600~900 ±2.4
>100~300	±0.5	X.X ±0.2	150~200 ±0.3 350~400 ±0.5 900~OVER ±3.1
ABOVE 300	±0.6	X.XX ±0.1	200~250 ±0.35

 Description: **PRODUCTION SPEC.**  
(PACKAGE SPEC.)

SCALE --- UNIT --- USED ON COOLER

**A4**      DHS-B10670-04-PA      REV. 00  
 SIZE      SHEET 1 OF 2      ISSUE DATE:

CARTON ILLUSTRATE	SIZE	498(L)*298(w)*144(H)(mm)	PACKING QUANTITY	3 LAYERS/CARTON
	MATERIAL	3 LAYERS"AB" FLUTE	CARTON WEIGHT	0.8 kg (REF.)

CARTON

CUSTOMER PART NO.	
DELTA PART NO.	
QUANTITY	
P/O NO.	
DATE CODE	
GROSS WEIGHT	

TRAY PACKING ILLUSTRATE	SIZE	490(L)*290(w)*37(H)(mm)	PACKING QUANTITY	8 PCS/TRAY
	MATERIAL	PET		
	MATERIAL WEIGHT	150g (REF.)		

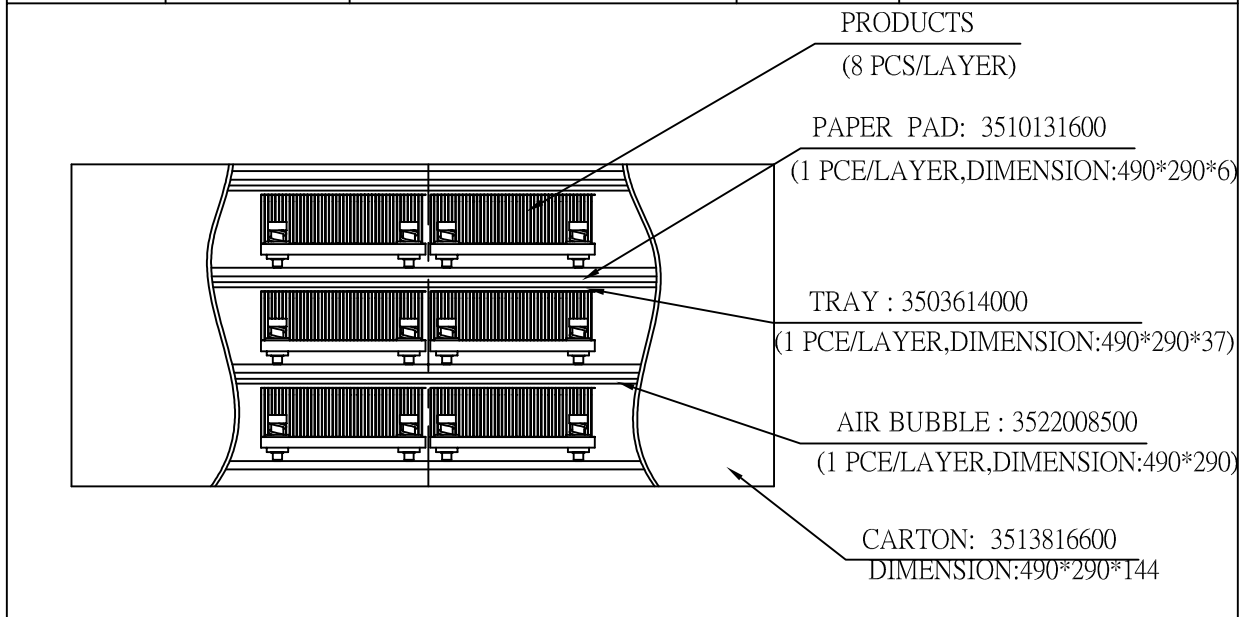

台達電子工業股份有限公司  
DELTA ELECTRONICS, INC.

DELTA MODEL:  
DHS-B10670-04

Drawn:  
Skyler 05/28'12

THESE DRAWINGS AND SPECIFICATIONS ARE THE PROPERTY OF DELTA ELECTRONICS, INC. AND SHALL NOT BE REPRODUCED OR USED AS THE BASIS FOR THE MANUFACTURE OR SELL OF APPARATUSES OR DEVICES WITHOUT PERMISSION.

CUSTOMER NAME: -----  
CUSTOMER P/N: -----

DIMENSIONAL TOLERANCES		HOLES : ±0.05		ANGLES : ±0.5°				
( )	( )	( )	( )	( )	( )			
<30	±0.25	DECIMALS	UP~100	±0.2	250~300	±0.4	UP~600	±1.5
>30~100	±0.35	X	100~150	±0.25	300~350	±0.45	600~900	±2.4
>100~300	±0.5	X.X	150~200	±0.3	350~400	±0.5	900~OVER	±3.1
ABOVE 300	±0.6	X.XX	200~250	±0.35				

THIRD ANGLE PROJECTION

Description: **PRODUCTION SPEC.**  
(PACKAGE SPEC.)

**A4**

DHS-B10670-04-PA

REV. 00

SCALE	---	UNIT	---	USED ON	COOLER	SHEET	2	OF	2	ISSUE DATE:	
-------	-----	------	-----	---------	--------	-------	---	----	---	-------------	--