

# C&K 7000 Series Miniature Toggle Switches

## Features/Benefits

- Multi-pole and multi-position
- Wide variety of actuator and termination options
- Epoxy sealed terminals prevent contamination during soldering

## Typical Applications

- Telecommunications
- Instrumentation
- Medical equipment

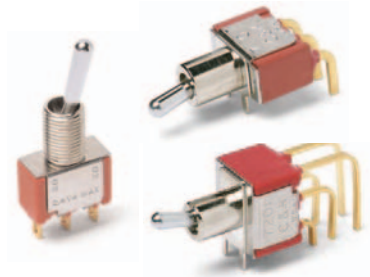

## Specifications

CONTACT RATING: B contact material: 0.4 VA max. @ 20 V AC or DC max. Q contact material: 5 AMPS @ 120 V AC or 28 V DC; 2 AMPS @ 250 V AC. See page F-16 for additional ratings.

ELECTRICAL LIFE: 7X01 and UX1 models: 100,000 make-and-break cycles at full load. All other models: 40,000 cycles.

CONTACT RESISTANCE: Below 10 m Ω typ. initial @ 2-4 V DC, 100 mA, for both silver and gold plated contacts.

INSULATION RESISTANCE: 10<sup>9</sup> Ω min.

DIELECTRIC STRENGTH: 1000 Vrms min. @ sea level.

OPERATING TEMPERATURE: -30°C to 85°C.

SOLDERABILITY: Per MIL-STD-202F method 208D, or EIA RS-186E method 9 (1 hour steam aging).

For materials see page F-4.

NOTE: Specifications listed above are for switches with standard options. For information on specific and custom switches, consult Customer Service Center.

## Build-A-Switch

To order, simply select desired option from each category and place in the appropriate box. Available options are shown and described on pages F-4 thru F-16. For additional options not shown in catalog, consult our Customer Service Center.

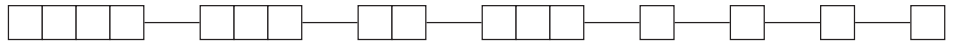

### Switch Function

- 7101 (STD.) SP On-None-On
- 7103 (STD.) SP On-Off-On
- 7105 SP Mom.-Off-Mom.
- 7107 SP On-Off-Mom.
- 7108 SP On-None-Mom.
- 7109 SP None-On-Mom.
- 7201 (STD.) DP On-None-On
- 7203 (STD.) DP On-Off-On
- 7205 DP Mom.-Off-Mom.
- 7207 DP On-Off-Mom.
- 7208 DP On-None-Mom.
- 7211 (STD.) DP On-On-On
- 7213 DP On-On-Mom.
- 7215 DP Mom.-On-Mom.
- 7301 (STD.) 3P On-None-On
- 7303 3P On-Off-On
- 7305 3P Mom.-Off-Mom.
- 7307 3P On-Off-Mom.
- 7308 3P On-None-Mom.
- 7401 (STD.) 4P On-None-On
- 7403 4P On-Off-On
- 7405 4P Mom.-Off-Mom.
- 7407 4P On-Off-Mom.
- 7408 4P On-None-Mom.
- 7411 4P On-On-On
- 7413 4P On-On-Mom.
- 7415 4P Mom.-On-Mom.

### Actuator

- M (STD.) .200" high
- P3 (STD.) Flatted, anti-rotation, .450" high
- S (STD.) .420" high
- T (STD.) .687" high, 15/32 bushing
- K2 Locking lever, .704" high
- K9 Locking lever, .704" high
- K12 Locking lever, .732" high
- K19 Locking lever, .732" high
- L .840" high
- L1 .640" high
- L1P Anti-rotation, .640" high
- L2 .550" high
- L2P Anti-rotation, .550" high
- L3 Plastic, .840" high
- L3P Plastic, anti-rotation, .840" high
- L40 Lever handle without cap
- L41 .531" high lever handle with cap
- L42 .838" high lever handle with cap
- MP Anti-rotation, .200" high
- P1 Flatted, anti-rotation, .840" high
- P4 Flatted, anti-rotation, .250" high
- SP Anti-rotation, .420" high
- T1 .487" high, 15/32 bushing
- T1P Anti-rotation, .487" high, 15/32 bushing
- T2P Flatted, anti-rotation, .610" high, 15/32 bushing
- TP Anti-rotation, .687" high, 15/32 bushing

### Bushing

- D (STD.) .280 high, keyway
- H (STD.) .296 high, flat
- Y (STD.) .350 high, keyway
- NONE No bushing choice required
- CW Splashproof
- D8 .280" high, flat
- D9 .280" high, keyway
- H3 .315" high, keyway
- H4 8mm high, keyway
- Y1 .378" high, keyway
- Y3 8.9mm high, keyway
- Y4 .378" high, flat
- Y9 .350" high, keyway

### Terminations

- A (STD.) Right angle, PC thru-hole
- AV2 (STD.) Vert. right angle, PC thru-hole
- C (STD.) PC Thru-hole
- V3 (STD.) .460 high, V-bracket
- Z (STD.) Solder lug
- A2 Right angle, PC thru-hole
- A3 Right angle, PC thru-hole
- A4 Right angle, PC thru-hole
- AV3 Vert. right angle, PC thru-hole
- AW1 Right angle, extended, PC thru-hole
- AW3 Right angle, extended, PC thru-hole
- AW4 Right angle, extended, PC thru-hole
- V2 .555" high, V-bracket
- V4 .630" high, V-bracket
- V6 .460" high, V-bracket
- V7 .630" high, V-bracket
- V8 .953" high, V-bracket
- V9 1.150" high, V-bracket
- V21 .555" high, snap-in V-bracket
- V31 .460" high, snap-in V-bracket
- V41 .630" high, snap-in V-bracket

### Contact Material

- B (STD.) Gold
- Q (STD.) Silver
- K Gold, tin-lead
- M Silver, tin-lead
- G Gold over silver
- L Gold over silver, tin-lead

### Seal

- E (STD.) Epoxy base
- I Epoxy potted base

### Actuator Color/Finish

- NONE (STD.) Bright chrome
- 0 (STD.) Actuator finish with black bushing
- 1 White
- 2 Black
- 3 Red
- S Satin chrome

### KXX Actuator Color/Finish

- NONE (STD.) Natural aluminum
- 0 (STD.) Natural aluminum with black bushing
- 2 Black anodized aluminum
- 3 Red anodized aluminum
- 7 Blue anodized aluminum

### Bushing Finish

- NONE (STD.) Nickel on all bushings (except D8, satin chrome)
- 2 Black

Note: UL/CSA models available, see pages F-4 & F-5.



F

Toggle

# C&K 7000 Series Miniature Toggle Switches

## Materials

CASE: Glass filled nylon 6/6, flame retardant, heat stabilized, or diallyl phthalate (DAP) (UL 94V-0).

ACTUATOR: Brass, chrome plated.

BUSHING: Brass or zinc, nickel plated.

HOUSING: Stainless steel.

SWITCH SUPPORT: Brass or steel, tin plated.

END CONTACTS: B contact material: Copper alloy, with gold plate over nickel plate. Q contact material: Coin silver, silver plated. See page F-16 for additional contact materials.

CENTER CONTACTS & ALL TERMINALS: B contact material: Copper alloy, with gold plate over nickel plate. Q contact material: Copper alloy, silver plated. See above for additional contact materials.

TERMINAL SEAL: Epoxy.

HARDWARE: Nut & Locking Ring: Brass, nickel plated.  
Lockwasher: Steel, nickel plated.

NOTE: Materials listed above are for switches with standard options. For information on specific and custom switches, consult Customer Service Center.

## SWITCH FUNCTION



NO. POLES	MODEL NO.	UL/CSA** MODEL NO.	SWITCH FUNCTION			CONNECTED TERMINALS			SCHEMATIC
			POS. 1	POS. 2	POS. 3	POS. 1	POS. 2	POS. 3	
SP	7101 (STD.)	U11	ON	NONE	ON	2-3	N/A	2-1	
	7103 (STD.)	U13	ON	OFF	ON	2-3	OPEN	2-1	
	7105	U15	MOM.	OFF	MOM.				
	7107	U17	ON	OFF	MOM.				
	7108	U18	ON	NONE	MOM.				
	7109	U19	NONE	ON	MOM.	N/A	2-3	2-1	

### SPDT

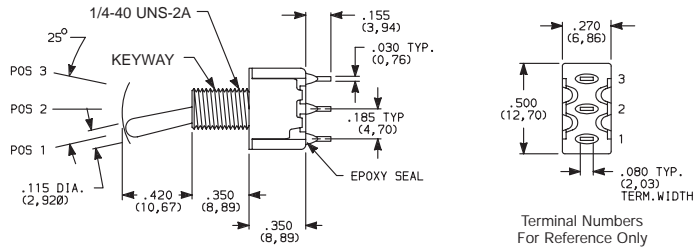

Part number shown: 7101SYZBE

DP	7201 (STD.)	U21	ON	NONE	ON	2-3,5-6	N/A	2-1,5-4	
	7203 (STD.)	U23	ON	OFF	ON	2-3,5-6	OPEN	2-1,5-4	
	7205	U25	MOM.	OFF	MOM.				
	7207	U27	ON	OFF	MOM.				
	7208	U28	ON	NONE	MOM.	2-3,5-6	N/A	2-1,5-4	
	7211 (STD.)*	U211*	ON	ON	ON	2-3,5-6	2-3,5-4	2-1,5-4	
	7213*	U213*	ON	ON	MOM.				
	7215*	U215*	MOM.	ON	MOM.				

### DPDT

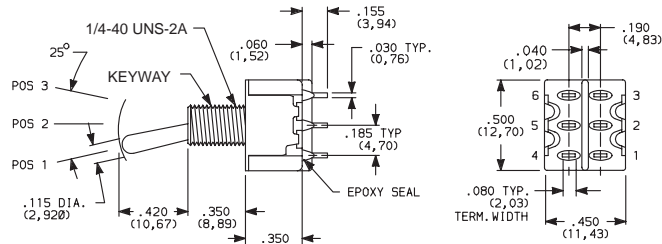

Part number shown: 7201SYZQE

MOM. = Momentary

\*\* U11-U415 model nos. with all options when ordered with G, L, M or Q contact material.

\* Wiring for 3-way switch, see Section N.



Third Angle Projection  
Dimensions are shown: IN (mm)  
Dimensions subject to change

# C&K 7000 Series Miniature Toggle Switches

## SWITCH FUNCTION

NO. POLES	MODEL NO.	UL/CSA** MODEL NO.	SWITCH FUNCTION			CONNECTED TERMINALS			SCHEMATIC
			POS. 1	POS. 2	POS. 3	POS. 1	POS. 2	POS. 3	
			KEYWAY	KEYWAY	KEYWAY	KEYWAY	KEYWAY	KEYWAY	
3P	7301 (STD.)	U31	ON	NONE	ON	2-3,5-6,8-9	N/A	2-1,5-4,8-7	
	7303	U33	ON	OFF	ON	2-3,5-6,8-9	OPEN	2-1,5-4,8-7	
	7305	U35	MOM.	OFF	MOM.				
	7307	U37	ON	OFF	MOM.				
	7308	U38	ON	NONE	MOM.				

### 3PDT

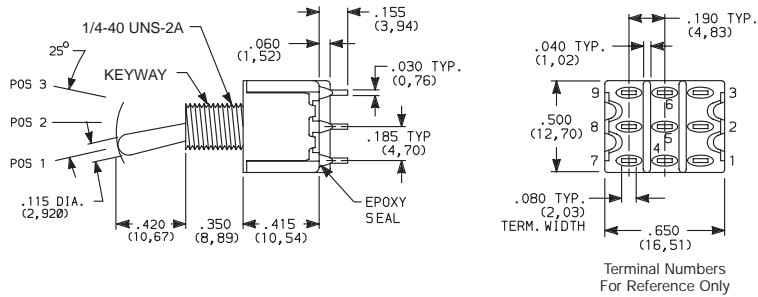

Part number shown: 7301SYZOE

Terminal Numbers For Reference Only

4P	7401 (STD.)	U41	ON	NONE	ON	2-3,5-6,8-9,11-12	N/A	2-1,5-4,8-7,11-10	
	7403	U43	ON	OFF	ON	2-3,5-6,8-9,11-12	OPEN	2-1,5-4,8-7,11-10	
	7405	U45	MOM.	OFF	MOM.				
	7407	U47	ON	OFF	MOM.				
	7408	U48	ON	NONE	MOM.				
	7411*	U411*	ON	ON	ON	2-3,5-6,8-9,11-12	2-3,5-4,8-9,11-10	2-1,5-4,8-7,11-10	
	7413*	U413*	ON	ON	MOM.				
7415*	U415*	MOM.	ON	MOM.					

### 4PDT

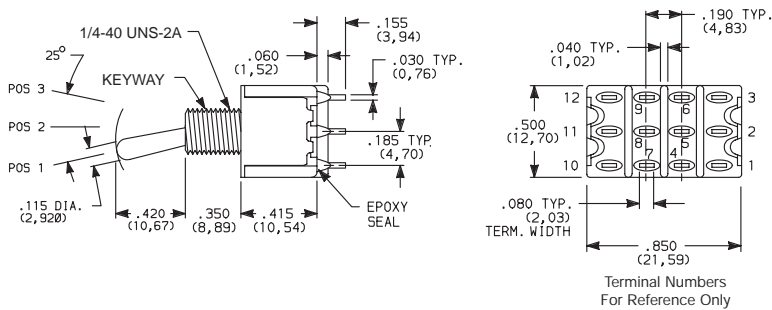

Part number shown: 7401SYZOE

MOM. = Momentary

\* Wiring for 3-way switch, see Section N.

\*\* U11-U415 model nos. with all options when ordered with G, L, M or Q contact material.



F

Toggle

# C&K 7000 Series Miniature Toggle Switches

## ACTUATOR

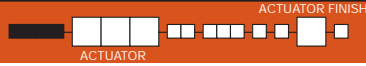

**S** (STD.) .420" HIGH <sup>1</sup>

**SP** ANTIROTATION, .420" HIGH <sup>2,3</sup>

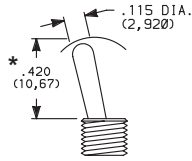

S actuator standard when ordered with C, W-W5, Z & Z3 terminations. Caps are available separately, see page F-16.

**M** (STD.) .200" HIGH <sup>1</sup>

**MP** ANTIROTATION, .200" HIGH <sup>2,3</sup>

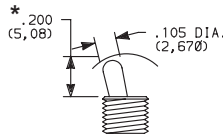

M actuator standard when ordered with all terminations except C, W-W5, Z & Z3. Caps are available separately, see page F-16.

**L, L1, L2** .840", .640", .550" HIGH <sup>1</sup>

**L1P, L2P** ANTIROTATION, .840", .640", .550" HIGH <sup>2,3</sup>

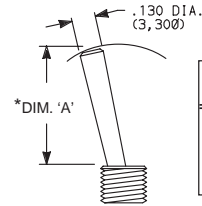

OPTION CODE	DIM 'A'
L	.840 (21,34)
L1, L1P	.640 (16,26)
L2, L2P	.550 (13,97)

Caps are available separately, see page F-16.

**P1** FLATTED WITH ANTIROTATION, .840" HIGH <sup>2,3</sup>

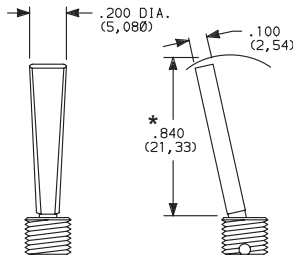

**P3** (STD.) FLATTED WITH ANTIROTATION, .450" HIGH <sup>2,3</sup>

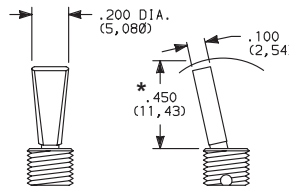

**P4** FLATTED WITH ANTIROTATION, .250" HIGH <sup>2,3</sup>

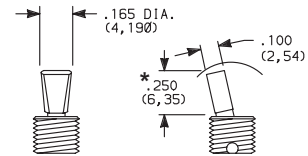

Dress nut part number 709901201 supplied standard with threaded bushing. (Part number 709903201 with metric threaded bushings.)

**T** (STD.) .687" HIGH <sup>1,2</sup>

**TP** ANTIROTATION, .687" HIGH, 15/32 BUSHING <sup>1,2,3</sup>

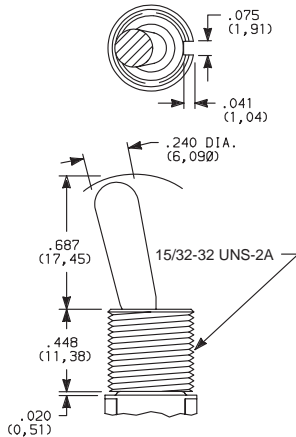

**T1** .487" HIGH <sup>1,2</sup>

**T1P** ANTIROTATION, .487" HIGH, 15/32 BUSHING <sup>1,2,3</sup>

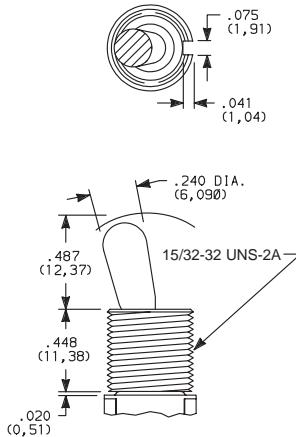

**T2P** FLATTED, ANTIROTATION, .610" HIGH, 15/32 BUSHING <sup>1,2,3</sup>

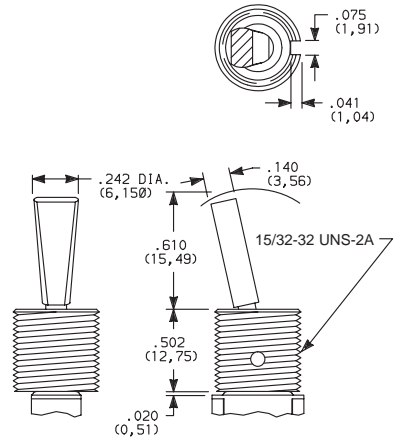

Bushing option code not required unless CW splashproof bushing ordered. TP & T1P actuators not available with CW splashproof bushing. All TXX actuators not available on single pole models with A-A7, AW-AW4, R terminations.

Bushing option code not required. T2P actuator not available with CW splashproof bushing or single pole models with A-A7, AW-AW4, R terminations.

Toggle

<sup>1</sup> L, L1, L2, M, S & TXX actuators not available with Y1 bushing.  
<sup>2</sup> L1P, L2P, MP, P1, P3, P4, SP & TXX actuators not available with D8 & H4 bushing.  
<sup>3</sup> Antirotation: Provides anti-'push-in' feature on actuator.  
 \* Add .070 (1,78) for D, D8 & D9 bushings, subtract .020 (0,51) for H3 bushing.

OPTION CODE	ACTUATOR FINISH
NONE	(STD.) BRIGHT CHROME-With Nickle Plated Bushing
2	(STD.) BLACK
0	BRIGHT CHROME-With Black Bushing
S	SATIN CHROME

**NOTE:** Black hardware is supplied when either black actuators or bushings are specified. For additional hardware, see section N.



Third Angle Projection  
 Dimensions are shown: IN (mm)  
 Dimensions subject to change

# C&K 7000 Series Miniature Toggle Switches

## ACTUATOR

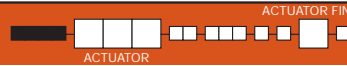

- K2** LOCKING LEVER, .704" HIGH (threaded)
- K9** LOCKING LEVER, .704" HIGH (unthreaded)

- K12** LOCKING LEVER, .732" HIGH (threaded)
- K19** LOCKING LEVER, .732" HIGH (unthreaded)

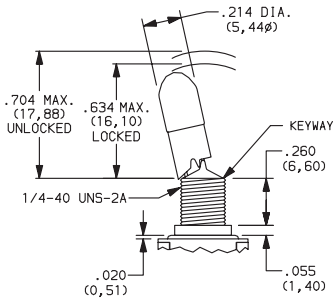

Replaces K, K8

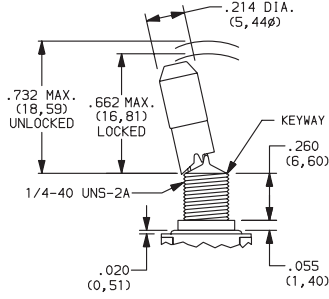

Replaces K1, K18

OPTION CODE	ACTUATOR CAP FINISH
<b>NONE</b>	(STD.) NATURAL ALUMINUM-With Nickel Plated Bushing
<b>0</b>	(STD.) NATURAL ALUMINUM-With Black Bushing
<b>2</b>	BLACK ANODIZED ALUMINUM
<b>3</b>	RED ANODIZED ALUMINUM
<b>7</b>	BLUE ANODIZED ALUMINUM

### Locking Positions



-01 Models  
2 Position lock



-03 & -11 Models  
3 Position lock



-05, -09 & -15 Models  
1 Position lock



-07 & -13 Models  
2 Position lock



-08 Models  
1 Position lock

**NOTE:** To prevent accidental actuation, toggle must be lifted before being actuated. When released, toggle will lock in place. Overtightening mounting nut may cause actuator to bind. Locking levers supplied with bushing shown. Bushing option code not required unless CW splashproof bushing ordered.

### L40 LEVER HANDLE WITHOUT CAP

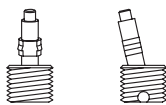

No color choice required.

### L41 PLASTIC LEVER HANDLE WITH ANTIROTATION AND CAP, P/N 4810

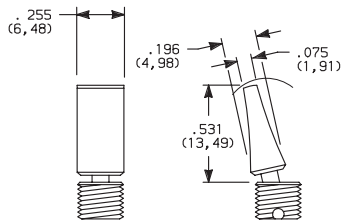

Finish: Matte (L41 & L42).

### L42 PLASTIC LEVER HANDLE WITH ANTIROTATION AND CAP, P/N 4811

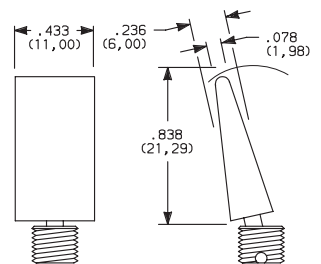

### L3 PLASTIC, .840" HIGH

### L3P ANTIROTATION, .840" HIGH

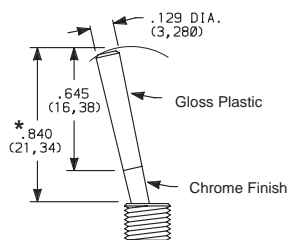

OPTION CODE	PLASTIC ACTUATOR COLORS
<b>NONE</b>	(STD.) No Actuator Color (L40 option)
<b>2</b>	(STD.) BLACK
<b>1</b>	WHITE
<b>3</b>	RED

**NOTE:** Lever handle for L41 & L42 actuators supplied, but not installed. For interchangeability, order L40 actuator option and lever handles separately, see page F-17. L4X actuators not available with H4, Y1, Y4 bushings. Antirotation: Provides anti-'push-in' feature on actuator.

\* Add .070 (1, 78) for D, D8 & D9 bushings, subtract .020 (0, 51) for H3 bushing.



Third Angle Projection  
Dimensions are shown: IN (mm)  
Dimensions subject to change



F

Toggle

# C&K 7000 Series Miniature Toggle Switches

## BUSHING

BUSHING FINISH

BUSHING

**Y** (STD.) .350" HIGH, THREADED, KEYWAY  
**Y9** .350" HIGH, UNTHREADED, KEYWAY

**NONE** NO BUSHING  
No bushing choice required with KXX, TXX actuators. (exception: Specify CW if splashproof bushing desired).

**D** (STD.) .280" HIGH, THREADED, KEYWAY  
**D8** .280" HIGH, UNTHREADED, FLAT<sup>3</sup>  
**D9** .280" HIGH, UNTHREADED, KEYWAY

**H** (STD.) .296" HIGH, FLAT THREADED, HIGH TORQUE<sup>1,2</sup>

**H3** .315" HIGH, KEYWAY THREADED, HIGH TORQUE<sup>1,2</sup>

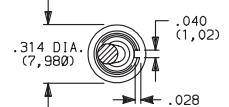
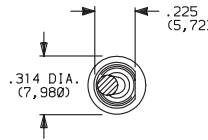
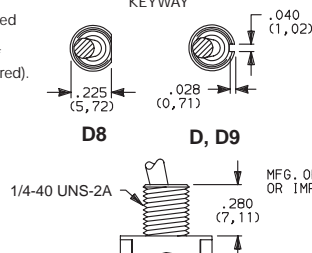
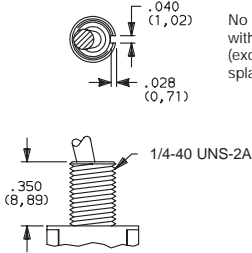

Y bushing standard with C, W-W5, Z or Z3 terminations.

D9 bushing standard with all terminations except C, W-W5, Z or Z3. Add .070 (1,78) to all actuator lengths with D, D8 & D9 bushings.

Subtract .020 (0,51) from all actuator lengths for H3 bushing.

**H4** 8mm HIGH, KEYWAY, THREADED, METRIC HIGH TORQUE<sup>1,2,3</sup>

**Y1** .378" HIGH, KEYWAY, THREADED, HIGH TORQUE<sup>1,2,4</sup>

**Y3** 8.9mm HIGH, KEYWAY, THREADED, METRIC

**Y4** .378" HIGH, FLAT, THREADED, HIGH TORQUE<sup>1,2,5</sup>

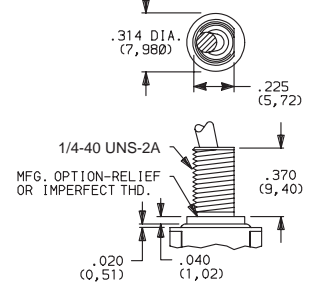
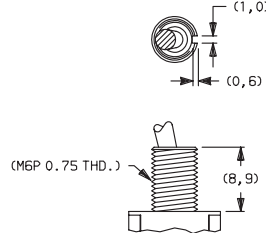
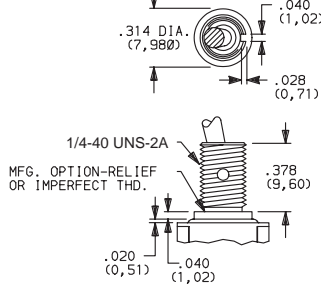
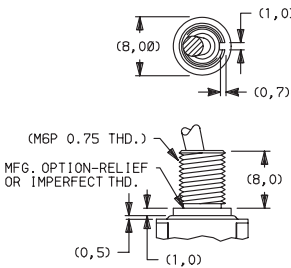

**CW** THREADED, SPLASHPROOF<sup>1,2</sup>

For T & T1 actuators.

For actuators other than T & T1.

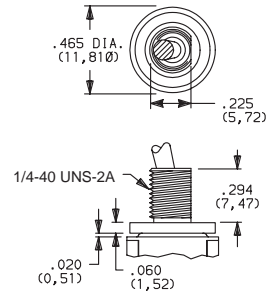
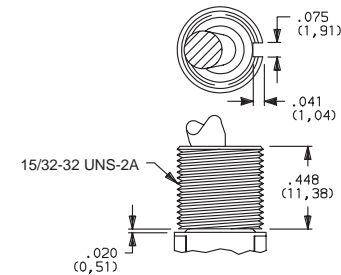

IP67 Degree of protection, totally protected against dust, full-scale voltage protection, temporary immersion. Internal actuator seal standard. External bushing seal washer available separately, order from: Multi-Flex Seals, Inc., Hackensack, NJ. Part number: MFS-60064.

IP67 Degree of protection, totally protected against dust, full-scale voltage protection, temporary immersion. Internal actuator seal and external bushing seal washer standard.

OPTION CODE	BUSHING FINISH
<b>NONE</b>	(STD.) NICKEL on all bushings except 'D8' satin chrome.
<b>2</b>	BLACK

- Will withstand 12 in.-lbs. of torque with no distortion.
- CW, H, H3, H4, Y1 & Y4 bushings not available on single pole models with A4, R terminations.
- D8 & H4 bushings available only with L, L1, L2, L3, M & S actuators.
- Y1 bushing available only with LP, LXP, MP, PX & SP actuators.
- Y4 bushing not available with L4X actuators.

**NOTE:** Two mounting nuts, locking ring and lockwasher supplied standard with threaded bushings. Black hardware is supplied when either black bushings or actuators are specified. Optional mounting nut and locking ring styles and finishes available, see section N.

### PANEL MOUNTING

1/4 INCH BUSHING

METRIC BUSHING

15/32 INCH BUSHING

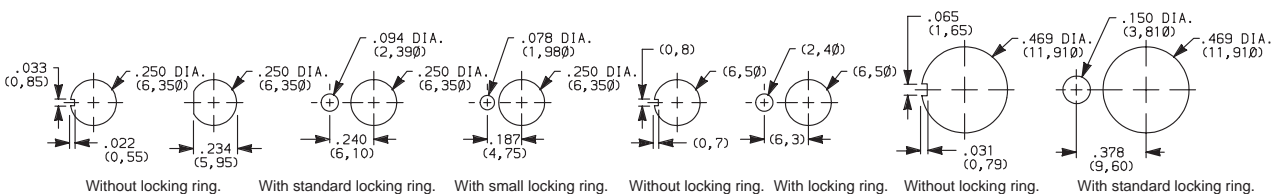

Third Angle Projection

Dimensions are shown: IN (mm)  
Dimensions subject to change

# C&K 7000 Series Miniature Toggle Switches

## TERMINATIONS

### Z (STD.) SOLDER LUG

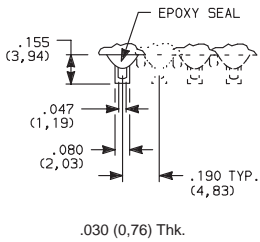

### C (STD.) PC THRU-HOLE

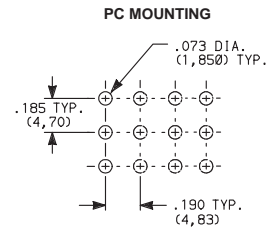
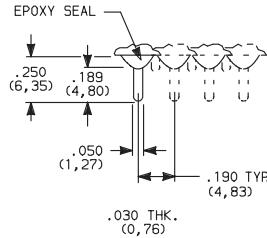

### SPDT thru 4PDT

Not available with K, L or M contact materials.

### SPDT thru 4PDT

### Z3 QUICK CONNECT

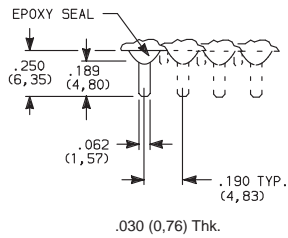

Not available with K, L or M contact materials.  
Mating quick connector available, order part number 530100000, page F-17.

### W, W1, W3, W4, W5 WIRE WRAP

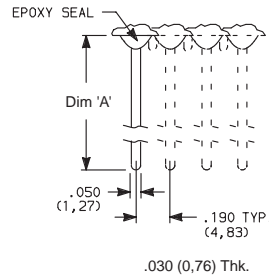

OPTION CODE	DIM 'A'
W	.750 (19,05)
W1	.964 (24,48)
W3	.425 (10,80)
W4	1.062 (26,97)
W5	1.305 (33,15)

### SPDT thru 4PDT

### SPDT thru 4PDT

### A (STD.) RIGHT ANGLE, PC THRU-HOLE

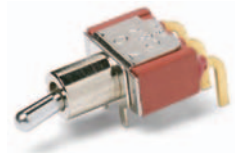
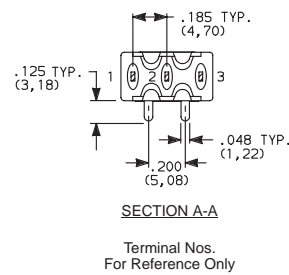
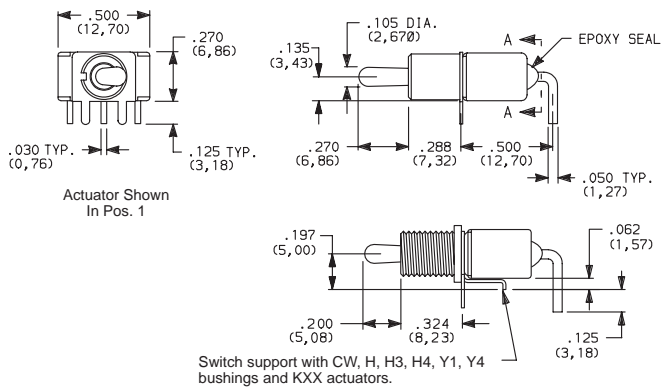

7101MD9ABE  
Horizontal Actuation  
SPDT

Part No. Shown: 7101MHABE

### A3 RIGHT ANGLE, SNAP-IN, PC THRU-HOLE

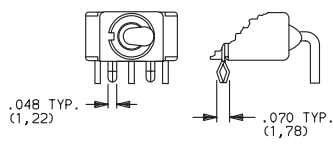

### AW1, AW3, AW4 RIGHT ANGLE, EXTENDED, PC THRU-HOLE

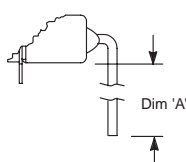

RIGHT ANGLE, EXTENDED,  
PC THRU-HOLE

OPTION CODE	DIM 'A'
AW1	.72 (18,3)
AW3	.20 (5,1)
AW4	.83 (21,1)

### PC MOUNTING

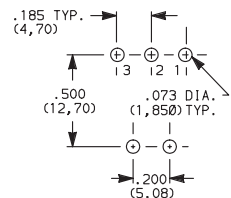

Not available with I seal option.  
Terminal bend radii and lead-in manufacturing option.



Third Angle  
Projection  
Dimensions are shown: IN (mm)  
Dimensions subject to change



F

Toggle

# C&K 7000 Series Miniature Toggle Switches

## TERMINATIONS

**A** (STD.) RIGHT ANGLE, PC THRU-HOLE

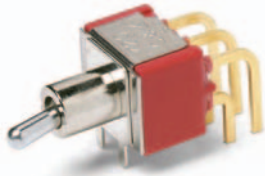

**7201MD9ABE**  
Horizontal Actuation  
DPDT

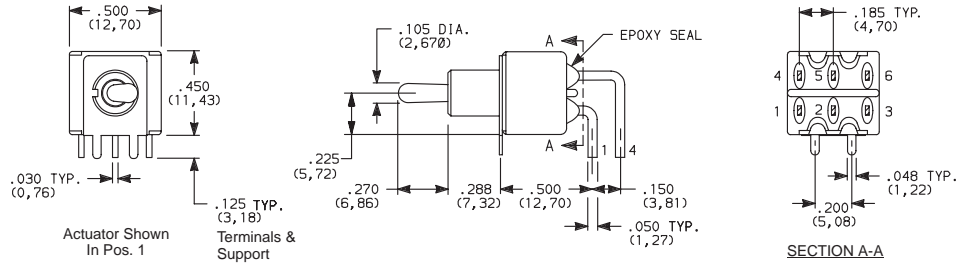

**A3** RIGHT ANGLE, SNAP-IN, PC THRU-HOLE

**AW1, AW4** RIGHT ANGLE, EXTENDED, PC THRU-HOLE

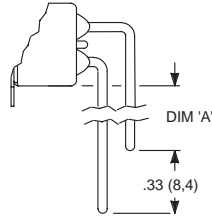
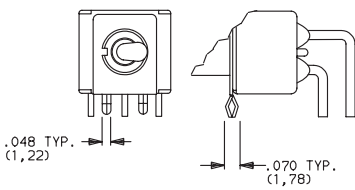

OPTION CODE	DIM 'A'
<b>AW1</b>	.40 (10,2)
<b>AW4</b>	.50 (12,7)

PC MOUNTING

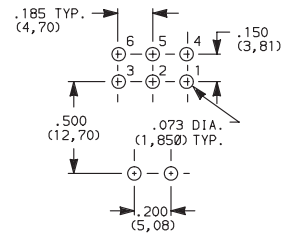

Not available with I seal option.  
Terminal bend radii and lead-in manufacturing option.

**A** (STD.) RIGHT ANGLE, PC THRU-HOLE



**7301MD9ABE**  
Horizontal Actuation  
3PDT

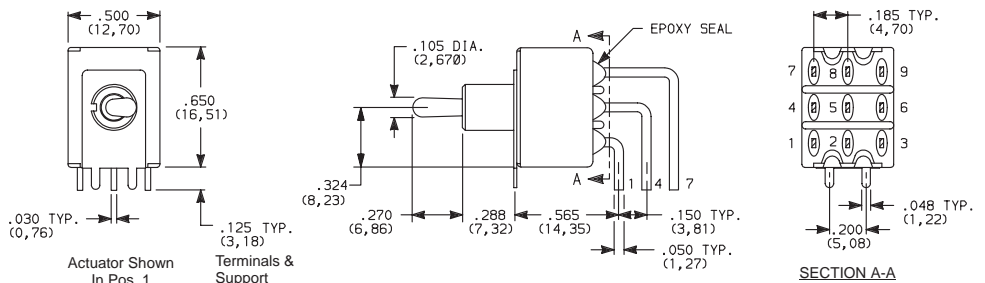

**AW4** RIGHT ANGLE, EXTENDED, PC THRU-HOLE

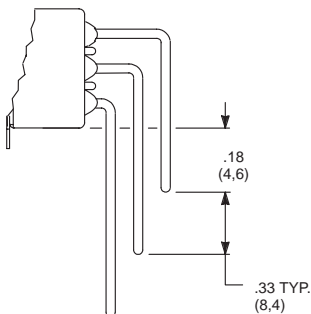

PC MOUNTING

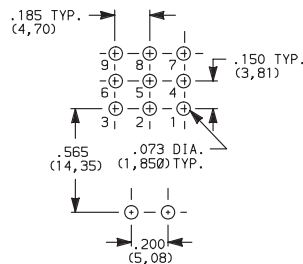

Not available with I seal option.  
Terminal bend radii and lead-in manufacturing option.

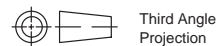

Dimensions are shown: IN (mm)  
Dimensions subject to change



# C&K 7000 Series Miniature Toggle Switches

## TERMINATIONS

### A2 RIGHT ANGLE, PC THRU-HOLE, .156" PITCH

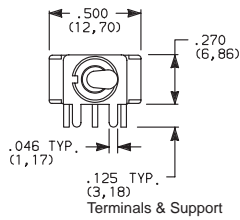

Actuator Shown In Pos. 1

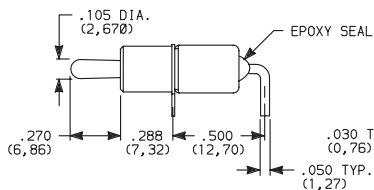

Switch support with CW, H, H3, H4, Y1, Y4 bushings and KXX actuators.

Part No. Shown: 7101MHA2BE

Not available with TXX actuators and I seal.  
Terminal bend radii and lead-in manufacturing option.

#### PC MOUNTING

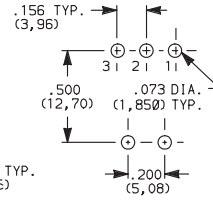

7101MHA2BE  
Horizontal Actuation  
SPDT

### A4 RIGHT ANGLE, PC THRU-HOLE .156" PITCH

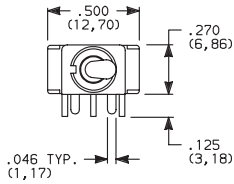

Actuator Shown In Pos. 1

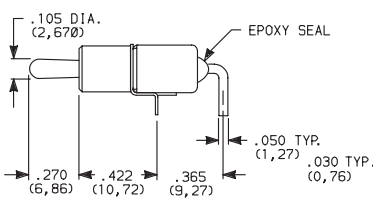

#### PC MOUNTING

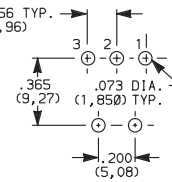

7101MD9A4BE  
Horizontal Actuation  
SPDT

Not available with KXX & TXX actuators, CW, H, H3, H4, Y1 & Y4 bushings, and I seal. Terminal bend radii and lead-in manufacturing option.

NOTE: The A4 option is available with any contact material and can be UL recognized and CSA certified. The PC pattern must clear switch support legs.

### AV2 (STD.) VERTICAL RIGHT ANGLE, PC THRU-HOLE, .150" PITCH

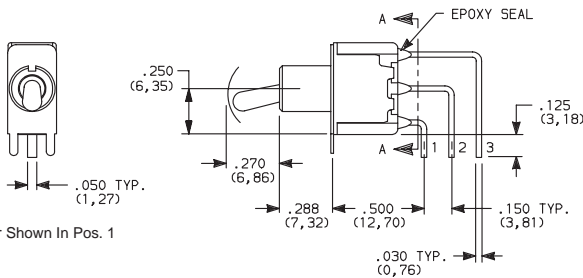

Actuator Shown In Pos. 1

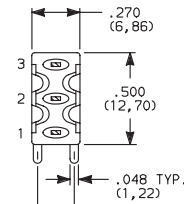

SECTION A-A



7101MD9AV2BE  
Horizontal Actuation  
SPDT

### AV3 VERTICAL RIGHT ANGLE, SNAP-IN, PC THRU-HOLE, .150" PITCH

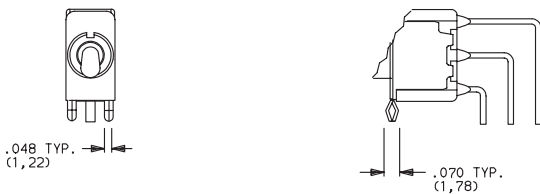

#### PC MOUNTING

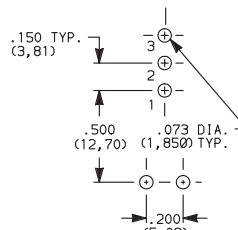

Not available with I seal option.  
Terminal bend radii and lead-in manufacturing option.



Third Angle  
Projection  
Dimensions are shown: IN (mm)  
Dimensions subject to change

# C&K 7000 Series Miniature Toggle Switches

## TERMINATIONS

**AV2** (STD.) VERTICAL RIGHT ANGLE, PC THRU-HOLE,  
.150" PITCH



7201MD9AV2BE  
Vertical Actuation  
DPDT

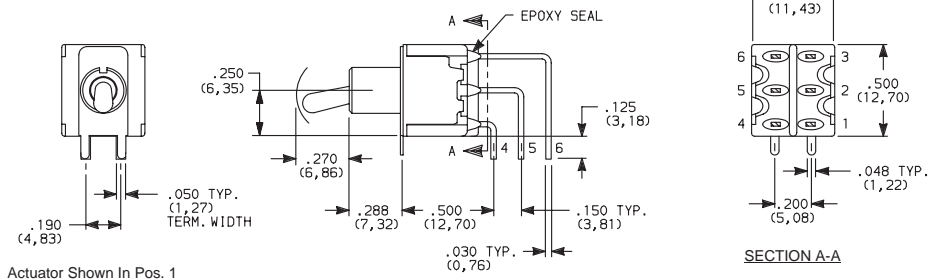

**AV3** VERTICAL RIGHT ANGLE, SNAP-IN, PC THRU-HOLE,  
.150" PITCH

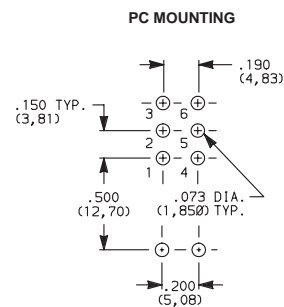
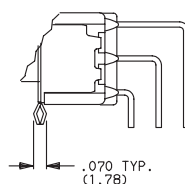
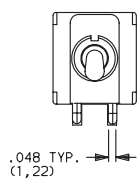

Not available with I seal option.  
Terminal bend radii and lead-in manufacturing option.

**AV2** (STD.) VERTICAL RIGHT ANGLE, PC THRU-HOLE,  
.150" PITCH



7301MD9AV2BE  
Vertical Actuation  
3PDT

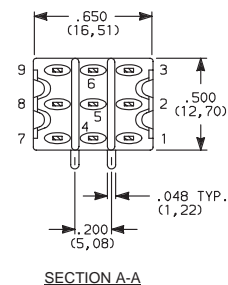
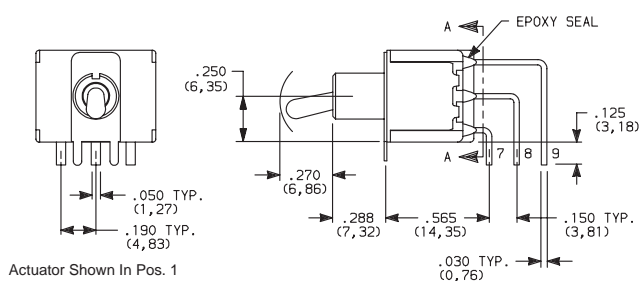

**AV3** VERTICAL RIGHT ANGLE, SNAP-IN, .150" PITCH

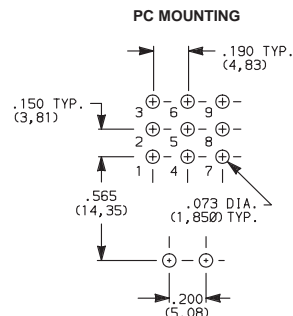
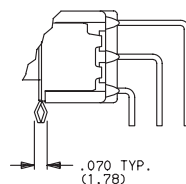
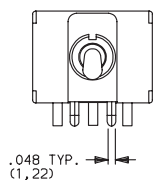

Not available with I seal option.  
Terminal bend radii and lead-in manufacturing option.

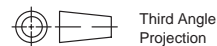

Dimensions are shown: IN (mm)  
Dimensions subject to change

# C&K 7000 Series Miniature Toggle Switches

## TERMINATIONS

### AV2 (STD.) VERTICAL RIGHT ANGLE, PC THRU-HOLE, .150" PITCH

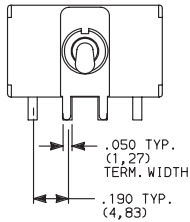

Actuator Shown In Pos. 1

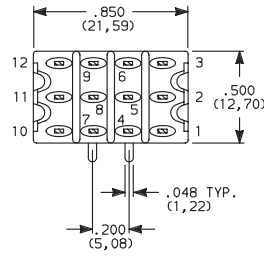
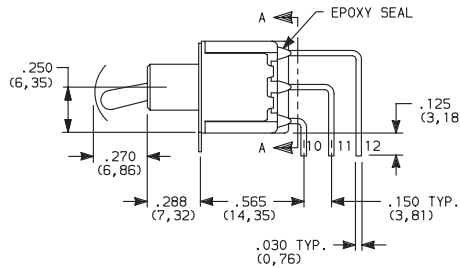

SECTION A-A



7401MD9AV2BE  
Vertical Actuation  
4PDT

### AV3 VERTICAL RIGHT ANGLE, SNAP-IN, PC THRU-HOLE .150" PITCH

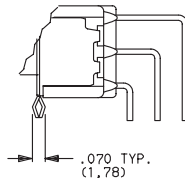
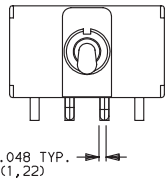

Not available with I seal option.  
Terminal bend radii and lead-in manufacturing option.

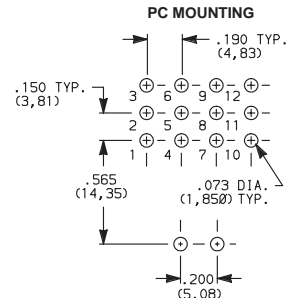

### V2, V6, V7, V8 VERTICAL MOUNT, V-BRACKET

### V21, V61, V71, V81 VERTICAL MOUNT, V-BRACKET, SNAP-IN

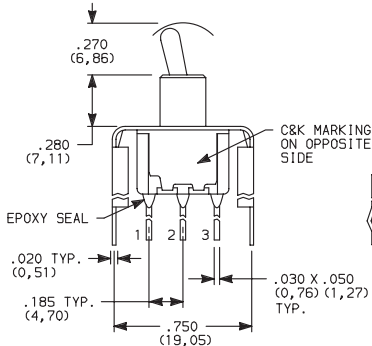

Actuator Shown In Pos. 1

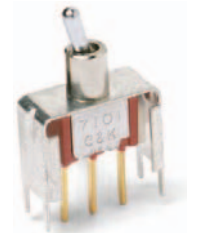
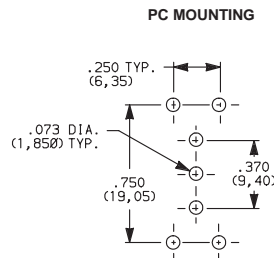
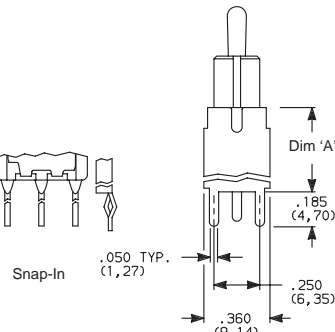

7101MD9\_BE  
SPDT

OPTION CODE	DIM 'A'
V2, V21	.555 (14,10)
V6, V61	.460 (11,68)
V7, V71	.630 (16,00)
V8, V81	.953 (24,21)

Not available with I seal option.

### V2, V6, V7, V8 VERTICAL MOUNT, V-BRACKET

### V21, V61, V71, V81 VERTICAL MOUNT, V-BRACKET, SNAP-IN

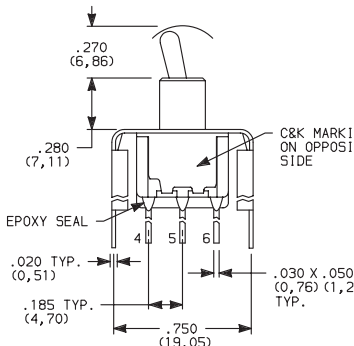

Actuator Shown In Pos. 1

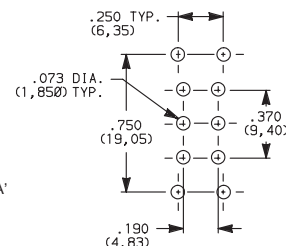
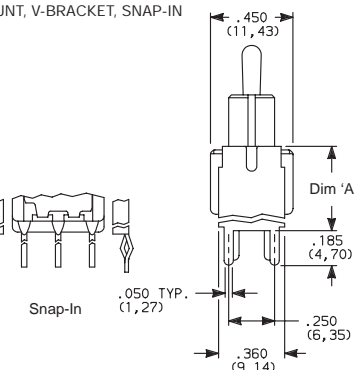

OPTION CODE	DIM 'A'
V2, V21	.555 (14,10)
V6, V61	.460 (11,68)
V7, V71	.630 (16,00)
V8, V81	.953 (24,21)

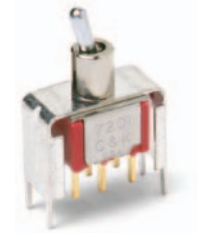

7201MD9\_BE  
DPDT

Not available with I seal option.



Cannon



Dimensions are shown: IN (mm)  
Dimensions subject to change



# C&K 7000 Series Miniature Toggle Switches

## TERMINATIONS



**V2, V7, V8** VERTICAL MOUNT, V-BRACKET

**V21, V71, V81** VERTICAL MOUNT, V-BRACKET, SNAP-IN



**7301MD9\_BE**  
**3PDT**

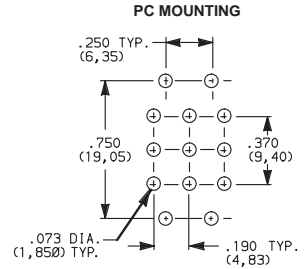
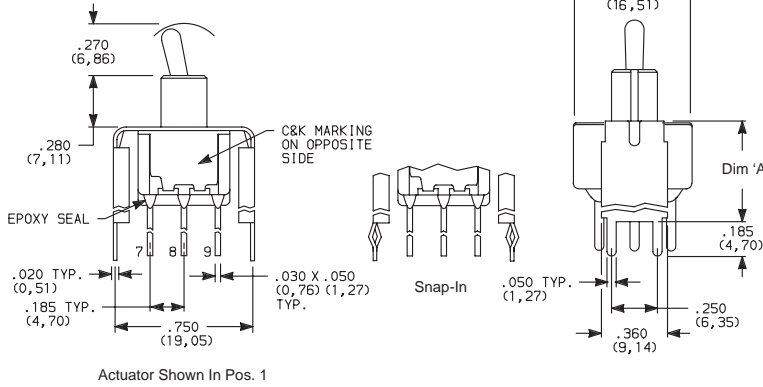

OPTION CODE	DIM 'A'
<b>V2, V21</b>	.555 (14,10)
<b>V7, V71</b>	.630 (16,00)
<b>V8, V81</b>	.953 (24,21)

Not available with I seal option.

**V2, V7, V8** VERTICAL MOUNT, V-BRACKET

**V21, V71, V81** VERTICAL MOUNT, V-BRACKET, SNAP-IN



**7401MD9\_BE**  
**4PDT**

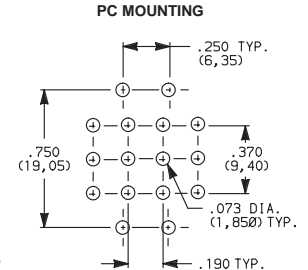
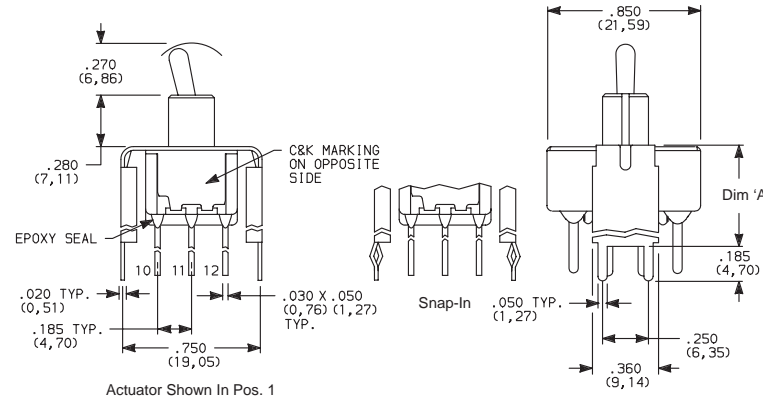

OPTION CODE	DIM 'A'
<b>V2, V21</b>	.555 (14,10)
<b>V7, V71</b>	.630 (16,00)
<b>V8, V81</b>	.953 (24,21)

Not available with I seal option.

**V3 (STD.), V4, V9** VERTICAL MOUNT, V-BRACKET

**V31, V41** VERTICAL MOUNT, V-BRACKET, SNAP-IN



**7101MD9\_BE**  
**SPDT**

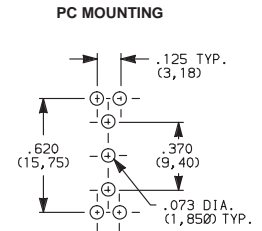
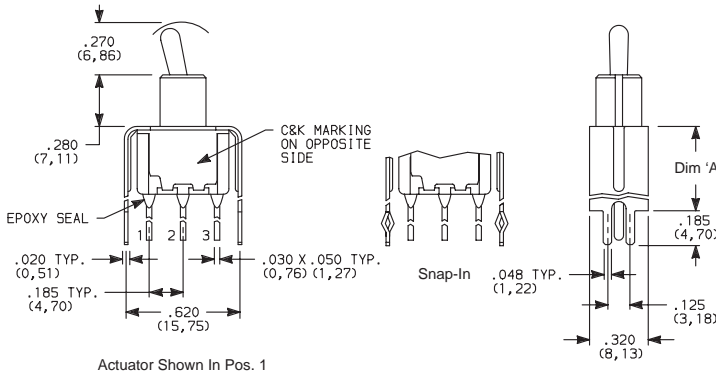

OPTION CODE	DIM 'A'
<b>V3, V31</b>	.460 (11,68)
<b>V4, V41</b>	.630 (16,00)
<b>V9</b>	1.150 (29,21)

Not available with I seal option.



Dimensions are shown: IN (mm)  
Dimensions subject to change

# C&K 7000 Series Miniature Toggle Switches

## TERMINATIONS

**V3 (STD), V4, V9** VERTICAL MOUNT, V-BRACKET

**V31, V41** VERTICAL MOUNT, V-BRACKET, SNAP-IN

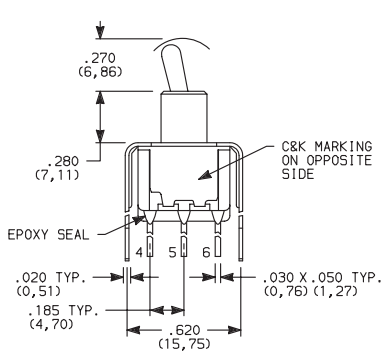

Actuator Shown In Pos. 1

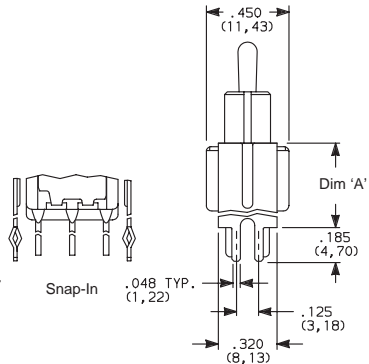

### PC MOUNTING

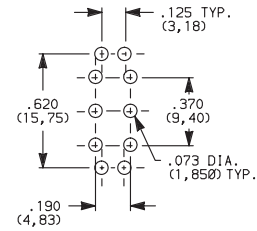

7201MD9\_BE  
DPDT

OPTION CODE	DIM 'A'
V3, V31	.460 (11,68)
V4, V41	.630 (16,00)
V9	1.150 (29,21)

Not available with I seal option.

**V4, V9** VERTICAL MOUNT, V-BRACKET

**V41** VERTICAL MOUNT, V-BRACKET, SNAP-IN

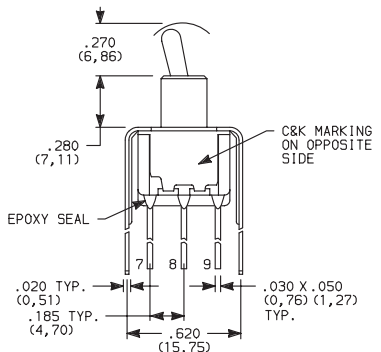

Actuator Shown In Pos. 1

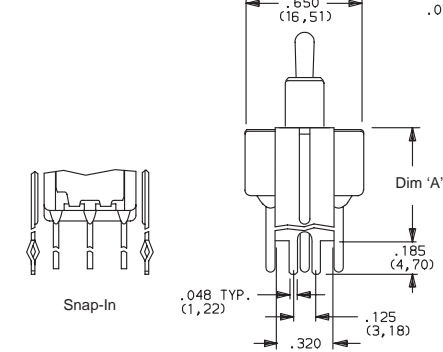

### PC MOUNTING

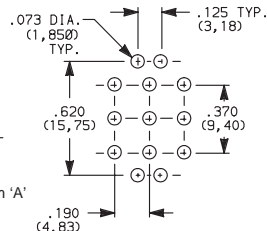

7301MD9\_BE  
3PDT

OPTION CODE	DIM 'A'
V4, V41	.630 (16,00)
V9	1.150 (29,21)

Not available with I seal option.

**V4, V9** VERTICAL MOUNT, V-BRACKET

**V41** VERTICAL MOUNT, V-BRACKET, SNAP-IN

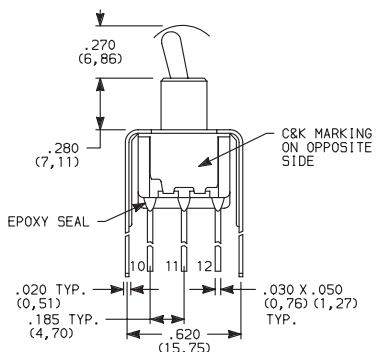

Actuator Shown In Pos. 1

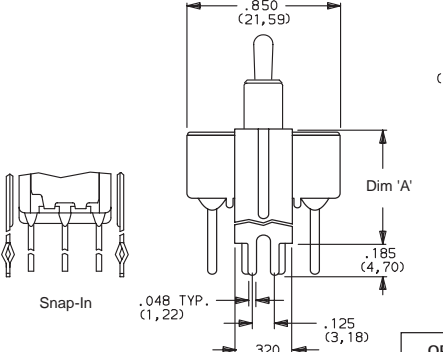

### PC MOUNTING

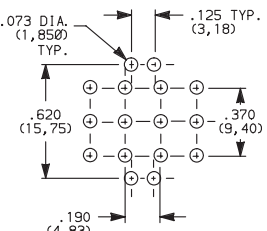

7401MD9\_BE  
4PDT

OPTION CODE	DIM 'A'
V4, V41	.630 (16,00)
V9	1.150 (29,21)



Third Angle Projection  
Dimensions are shown: IN (mm)  
Dimensions subject to change

Not available with I seal option.



Cannon



# C&K 7000 Series Miniature Toggle Switches

## CONTACT MATERIAL

OPTION CODE	CONTACT MATERIAL	TERMINAL PLATING	RATINGS	
<b>B (STD.)</b>	GOLD <sup>1</sup>	GOLD <sup>1</sup>	LOW LEVEL/DRY CIRCUIT	0.4 VA MAX. @ 20 V AC OR DC MAX.
<b>K</b>		TIN-LEAD <sup>6</sup>		
<b>Q (STD.)</b>	SILVER <sup>4,5</sup>	SILVER <sup>5</sup>	POWER	5 AMPS @ 120 V AC OR 28 V DC; 2 AMPS @ 250 V AC.
<b>M</b>		TIN-LEAD <sup>6</sup>		
<b>G</b>	GOLD OVER SILVER <sup>2,3</sup>	GOLD <sup>3</sup>	LOW LEVEL/DRY CIRCUIT OR POWER	0.4 VA MAX @ 20 V AC OR DC MAX OR 5 AMPS @ 120 V AC OR 28 V DC; 2 AMPS @ 250 V AC.
<b>L</b>		TIN-LEAD <sup>6</sup>		

CONTACT MATERIAL/APPLICATION RECOMMENDATIONS-SEE SECTION N.

<sup>1</sup> CONTACTS & TERMINALS: Copper alloy, with gold plate over nickel plate.

<sup>2</sup> END CONTACTS: Coin silver, with gold plate over nickel plate.

<sup>3</sup> CENTER CONTACTS & ALL TERMINALS: Copper alloy, with gold plate over nickel plate.

<sup>4</sup> END CONTACTS: Coin silver, silver plated.

<sup>5</sup> CENTER CONTACT & ALL TERMINALS: Copper alloy, silver plated.

<sup>6</sup> TERMINALS: Copper alloy, with tin-lead alloy over nickel plate.

U11-U415 model numbers   with all options when ordered with G, L, M or Q contact material.

B contact material standard with all terminations except C, Z & Z3.

B contact material standard must be ordered with A7 & R terminations.

Q contact material standard with C, Z & Z3 terminations.

K, L & M contact materials not available with Z & Z3 terminations.

## SEAL

### E (STD.) EPOXY SEAL

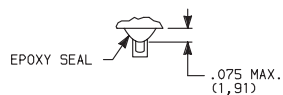

Compatible with "bottom-wash" PC board cleaning methods.

### I EPOXY POTTED BASE

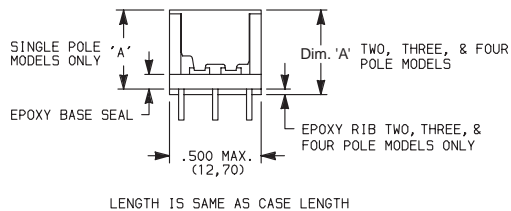

NO. POLES	DIM 'A'
SP	.410 (10,41)
DP	.440 (11,18)
3P	.505 (12,83)
4P	.505 (12,83)

Available with C, W-W5, Z & Z3 terminations only.

## AVAILABLE HARDWARE

Cap

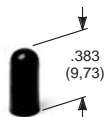

PART NO.

896801000 WHITE  
896802000 BLACK  
896803000 RED

Material: Polyethylene  
Finish: Matte

Cap

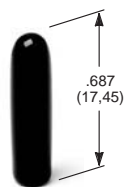

PART NO.

763701000 WHITE  
763702000 BLACK  
763703000 RED

Material: Vinyl  
Finish: Matte

Cap

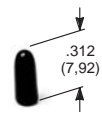

PART NO.

706201000 WHITE  
706202000 BLACK  
706203000 RED

Material: Vinyl  
Finish: Matte



F

Toggle

# C&K 7000 Series Miniature Toggle Switches

## AVAILABLE HARDWARE

L41 Lever handle

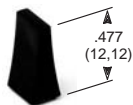

**PART NO.**  
**481001000** WHITE  
**481002263** BLACK  
**481003000** RED  
 Material: Nylon  
 Finish: Matte

L42 Lever handle

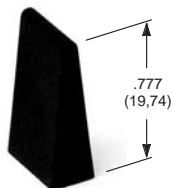

**PART NO.**  
**481101000** WHITE  
**481102263** BLACK  
**481103000** RED  
 Material: Nylon  
 Finish: Matte

Fits Z3 Termination  
female connector



**PART NO.**  
**530100000**  
 Available in loose pieces.

**NOTE:** Additional nuts, locking rings and lockwashers available separately, see section N.

Other colors available, consult Customer Service Center.