

MPS Series Magnetic Proximity Sensors

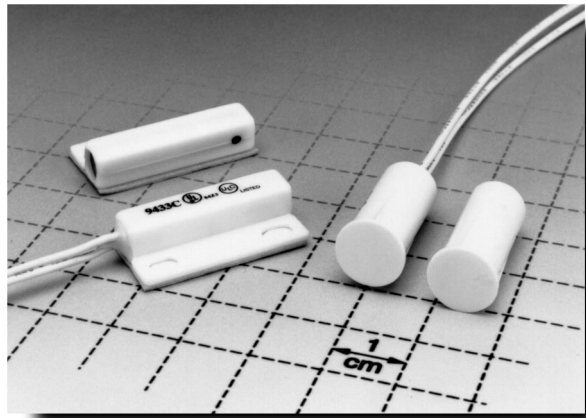

Features/Benefits

- Long life—10M operations
- Sealed contacts
- Quality construction
- Quick and easy installation

Typical Applications

- Automotive sensors and indicators
- Industrial sensors
- Factory automation equipment

How To Order

Complete part numbers for MPS Series Magnetic Proximity Sensors are shown on pages L-2 thru L-5.

Specifications

CONTACT RATINGS: 3.0 W max. @ 30 V DC or 30 V AC max. @ 0.3 AMP max.; 1.0 msec. max. operate time (including bounce); 1.0 AMP max. carry current.

CONTACT RESISTANCE: 100 milliohms max. initial.

DIELECTRIC STRENGTH: 200 V DC min.

ELECTRICAL CIRCUIT: SPST NO (Contact Form A). Reed switch opens when magnet is removed from proximity. Contacts are held closed when magnet is within actuation range.

OPERATING TEMPERATURE: -40°F to 212°F (-40°C to 100°C).

OPERATING DISTANCE /ALIGNMENT: Operate (pull-in or make) points are nominal values with $\pm 10\%$ tolerance. Release points are 110% to 150% of the operating points.

MECHANICAL & ELECTRICAL LIFE: 10 million operations.

PACKAGING: Bulk packaging, 10 switch and magnet pairs per package.

Materials

HOUSING/SPACER/COVER: ABS plastic (UL94V-0), white.

REED SWITCH: Rhodium coated reed contacts in hermetically sealed, nitrogen filled glass capsule. Closed when magnet is in close proximity. Used in closed loop circuits.

WIRE LEADS: UL 1061, 22 AWG wire: stranded, made of copper or aluminum; Length: 12 in. with ends stripped; Color: white.

POTTING (around wires): Epoxy.

MAGNETS: Alnico V (all models, except MPS80WG) and Ceramic Ferrite 8 (MPS80WG model only).

ADHESIVE MOUNTING: Foam-backed, pressure-sensitive adhesive with release liner (MPS45WGW model only).

NOTE: Wide gap contacts are polarity sensitive. Use alignment dots for proper installation of surface mount contacts.

Miscellaneous Components, Hardware & Technical Data

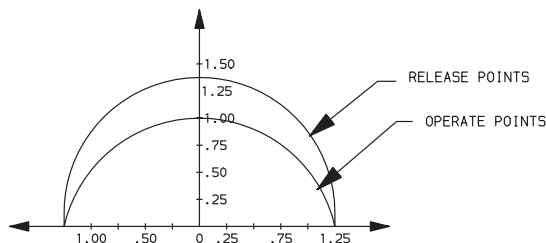
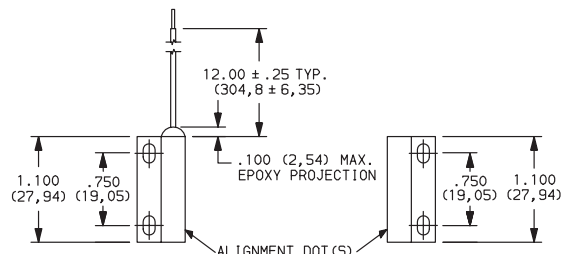
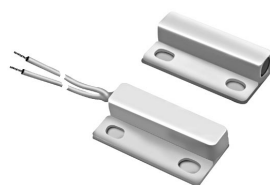

OFFSET OF CENTERLINES AND DISTANCE BETWEEN FACES OF SWITCH AND MAGNET (INCHES).

ACTUATION CHART

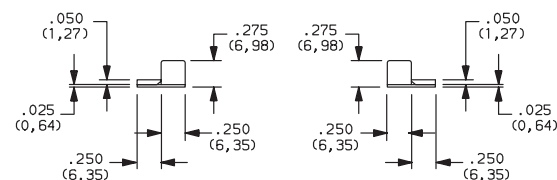

SWITCH

MAGNET

PART NUMBER	SWITCH TYPE
MPS45WGW	Subminiature surface mount (adhesive or flange), side exit leads, 1" make gap.



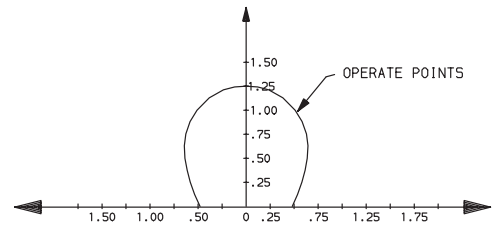
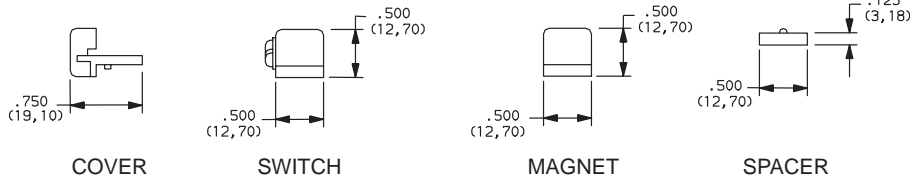
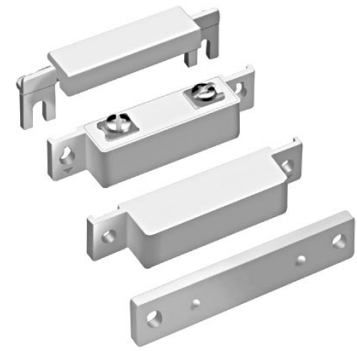
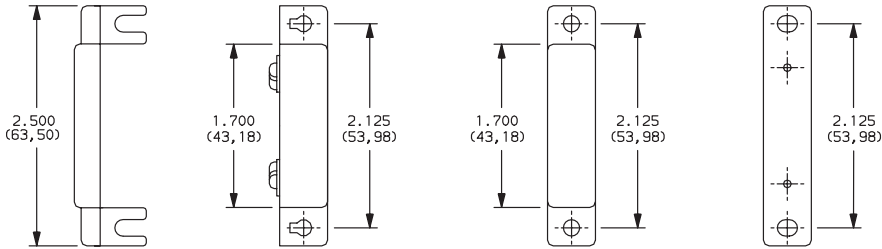

OFFSET OF CENTERLINES AND DISTANCE BETWEEN FACES OF SWITCH AND MAGNET (INCHES).

ACTUATION CHART

PART NUMBER	SWITCH TYPE
MPS20WGW	Standard surface mount, screw terminals, 1 1/4" make gap.

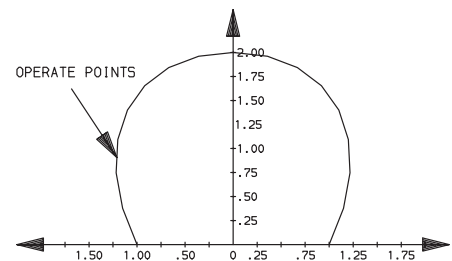
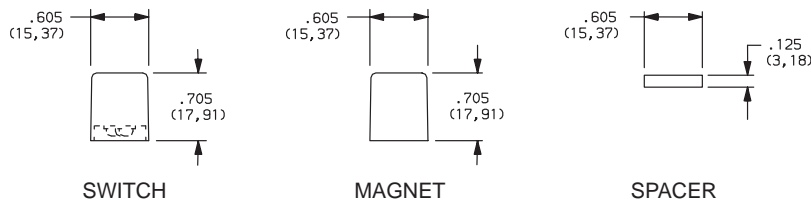
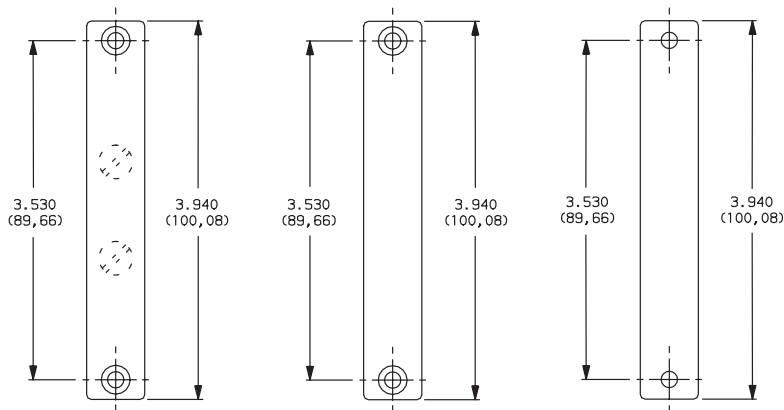

OFFSET OF CENTERLINES AND DISTANCE BETWEEN FACES OF SWITCH AND MAGNET (INCHES).

ACTUATION CHART

PART NUMBER	SWITCH TYPE
MPS80WGW	Industrial surface mount, concealed screw terminals, 2" make gap.



MPS Series Magnetic Proximity Sensors



Miscellaneous Components, Hardware & Technical Data

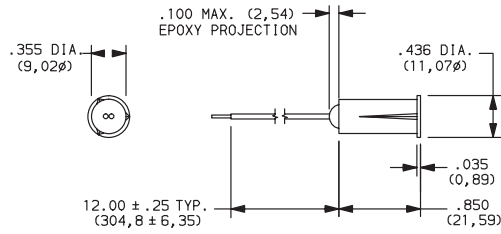
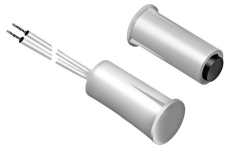

SWITCH

SWITCH & MAGNET
PANEL MOUNTING

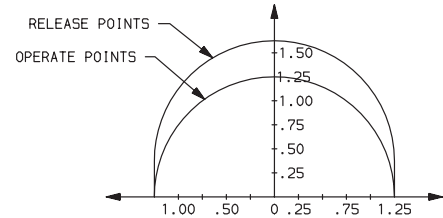
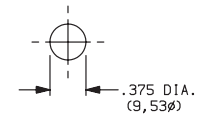

OFFSET OF CENTERLINES AND DISTANCE BETWEEN
FACES OF SWITCH AND MAGNET (INCHES).

ACTUATION CHART



PART NUMBER	SWITCH TYPE
MPS9WGW	3/8" Diameter recessed magnetic contact, 1 1/4" make gap.

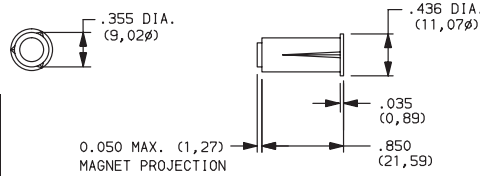

MAGNET

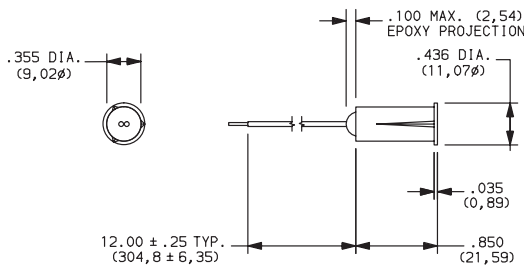
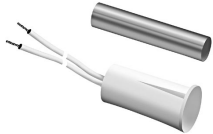

SWITCH

SWITCH
PANEL MOUNTING

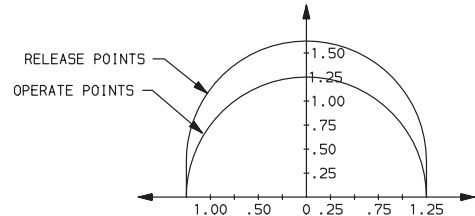
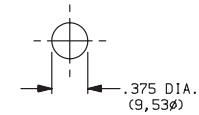

OFFSET OF CENTERLINES AND DISTANCE BETWEEN
FACES OF SWITCH AND MAGNET (INCHES).

ACTUATION CHART



PART NUMBER	SWITCH TYPE
MPS95WGW	3/8" Diameter recessed magnetic contact, 1 1/4" make gap.

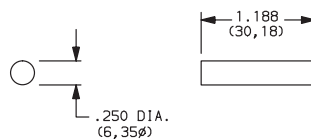

MAGNET

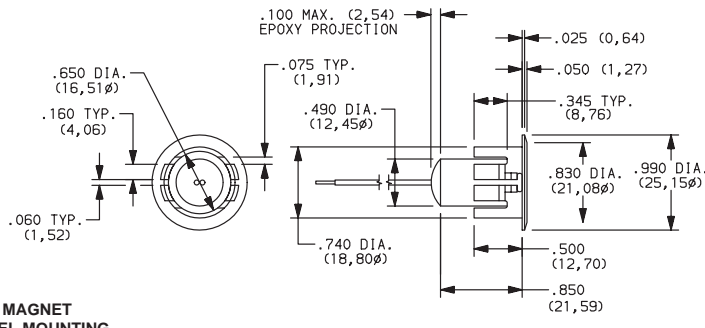
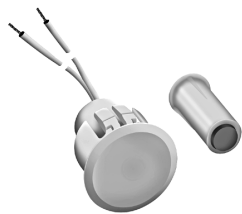

SWITCH
PANEL MOUNTING

MAGNET
PANEL MOUNTING

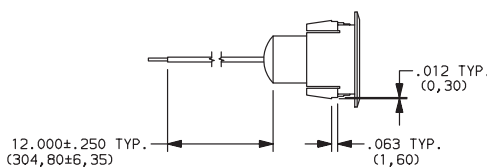
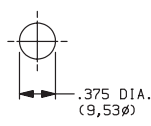
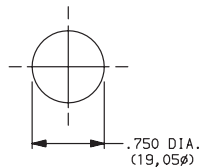

SWITCH

MAGNET

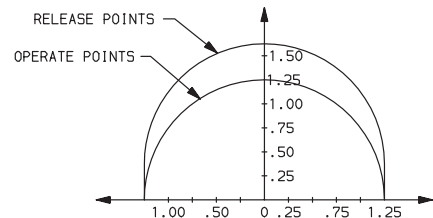

OFFSET OF CENTERLINES AND DISTANCE BETWEEN
FACES OF SWITCH AND MAGNET (INCHES).

ACTUATION CHART



PART NUMBER	SWITCH TYPE
MPS73WGW	3/4" Diameter recessed magnetic contact, 1 1/4" make gap.

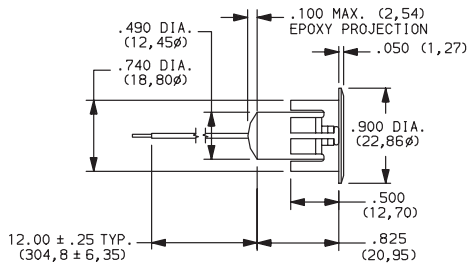

SWITCH

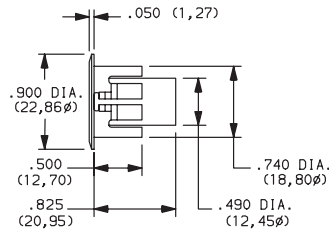

MAGNET



SWITCH & MAGNET
PANEL MOUNTING

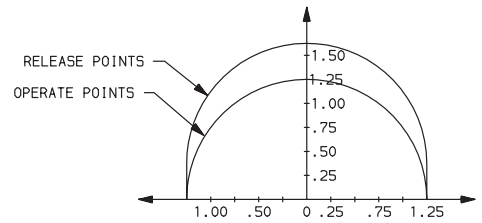
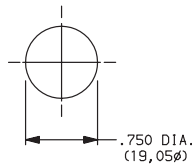

OFFSET OF CENTERLINES AND DISTANCE BETWEEN
FACES OF SWITCH AND MAGNET (INCHES).

ACTUATION CHART

PART NUMBER	SWITCH TYPE
MPS70GW	3/4" Diameter recessed magnetic contact, 1 1/4" make gap.



Actuating Positions

When installing recessed and surface mount contacts, magnet position is very important. The switch and magnet must always be parallel or end to end, and never in a 'T' configuration.

Gap Distance

Gap distance is a combination of the horizontal and vertical plane separation of the switch and magnet. Example: if a recessed magnet is 1/4" off the centerline of the switch, the make gap is reduced by 1/4".

Correct Configuration

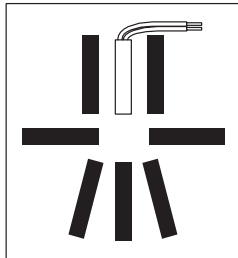

Incorrect Configuration

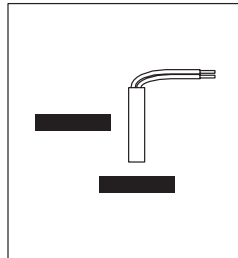

Center Alignment

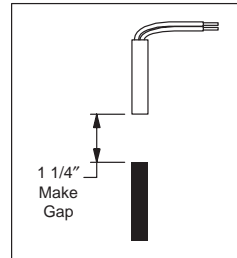

Off Center Alignment

