

# C&K PTS Series Subminiature Tactile Switches

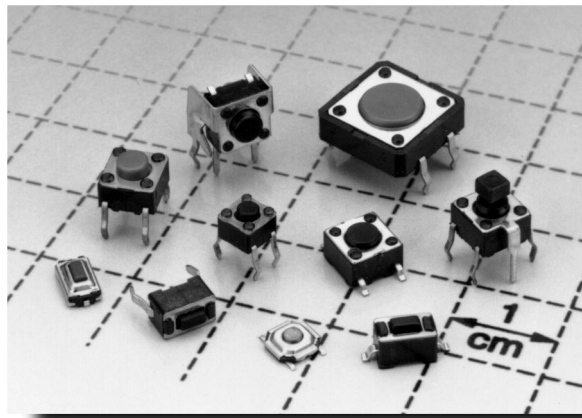

## Features/Benefits

- **Cost-effective solution**
- **Long life contact design**
- **Variety of actuator styles and package sizes**
- **Multiple actuation forces**

## Typical Applications

- **Consumer products**
- **Instrumentation**
- **Computer Products**
- **Hand-held devices**

## Specifications

CONTACT RATING: 50 mA @ 12 V DC.

MECHANICAL & ELECTRICAL LIFE: 20,000 operations for PTS635S/V models; 25,000 operations for PTS453S/T models; 100,000 operations for PTS645S/T, PTS645V, PTS645SJ/TJ and PTS645VJ models; 200,000 operations for PTS125S models. 300,000 for PTS525 models.

CONTACT RESISTANCE: 100 milliohms max. initial.

INSULATION RESISTANCE:  $10^9 \Omega$  min.

DIELECTRIC STRENGTH: 250 V AC min.

OPERATING TEMPERATURE:  $-10^\circ\text{C}$  to  $60^\circ\text{C}$ .

SOLDERABILITY: Preheating to  $100^\circ\text{C}$  for 45 sec. max. Keep flux flush with top surface of PCB; do not apply to component side of PCB and area where terminals are located. Soldering to  $255^\circ\text{C}$  for 5 sec. max. Clean by brushing on soldering surface. Do not clean switch with solvents. SMT capable of IR solder process, no cleaning process.

## Materials

BASE: 6/6 nylon or glass filled polyester (PBT) (UL 94HB).

ACTUATOR: 6/6 nylon or polyacetal (UL 94HB).

COVER PLATE: PTS453S, PTS635S, PTS635V models:

Tin-plated brass; PTS453T, PTS125, PTS645T, PTS645V, PTS645TJ, PTS645VJ models: Tin alloy; PTS645S models (Including TR): Polyester.

DOME CONTACTS: PTS635 models-stainless steel,

silver clad; all other models-phosphor bronze, silver clad.

STATIONARY CONTACTS: Brass, silver plated.



TERMINALS: Brass, silver plated. All terminals insert molded.

PACKAGING: Bulk packaging standard for PTS453, PTS635

and PTS645 models. Tube packaging standard for all PTS125 models.

Radial tape packaging available on PTS645S models; when ordering, add suffix 'TR' to part number. Switches supplied 1,000 pieces per box.

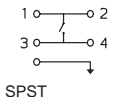
## 4.5 x 4.5mm Models

PART NUMBER	PART NUMBER (With ESD Pin)	OPERATING FORCE (TYP.)	DIM. 'H'	ACTUATOR COLOR	SCHEMATIC (With ESD Pin)	SCHEMATIC
<b>PTS453SL38</b>	<b>PTS453TL38</b>	130 g	0.150 (3,8)	Black		



PTS453TL38  
SPST

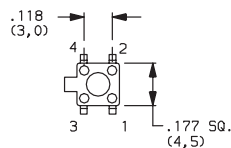

PC MOUNTING  
(With ESD Pin)

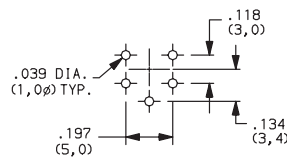

PC MOUNTING

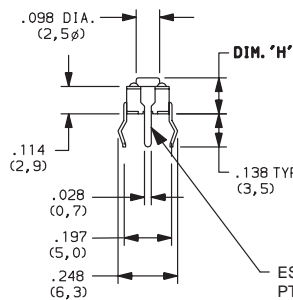
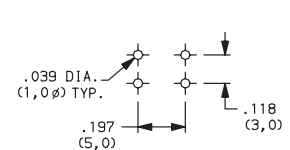

ESD PIN WITH  
PTS453TL38  
MODEL ONLY



# C&K PTS Series Subminiature Tactile Switches

## 5.25 x 5.25mm Surface Mount Model

PART NUMBER	OPERATING FORCE (TYP.)	ACTUATOR COLOR	SCHEMATIC
<b>PTS525SM10SM</b>	130 g	Black	 SPST

NOTE: Add suffix 'TR' to part number for tape and reel packaging.

### TAPE & REEL PACKAGING

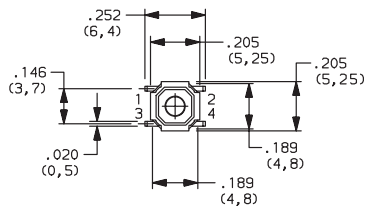
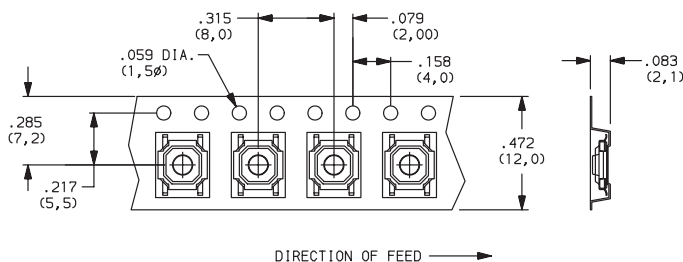

PTS525SM10SM  
SPST

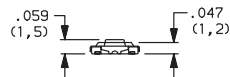
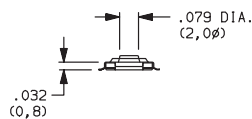

### PC MOUNTING

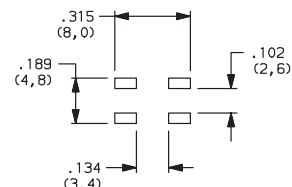

## 6 x 3.5mm Right Angle Models

PART NUMBER	OPERATING FORCE (TYP.)	DIM. 'H'	ACTUATOR COLOR	SCHEMATIC
<b>PTS635VL31</b>	130 g	0.124 (3,15)	Black	 SPST
<b>PTS635VL39</b>	130 g	0.151 (3,85)	Black	
<b>PTS635VH31</b>	200 g	0.124 (3,15)	Gray	
<b>PTS635VH39</b>	200 g	0.151 (3,85)	Gray	

### PC MOUNTING

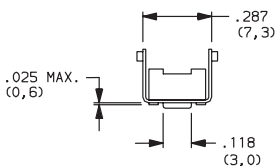
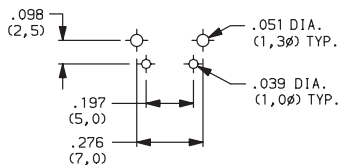

PTS635VL31  
SPST

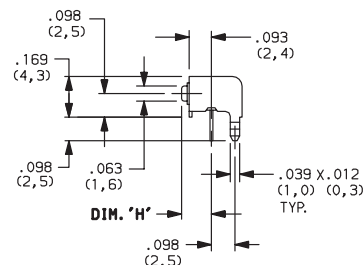
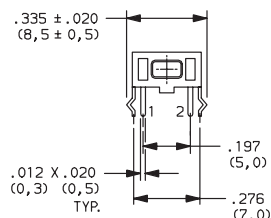

## 6 x 3.5mm Models

PART NUMBER	OPERATING FORCE (TYP.)	DIM. 'H'	ACTUATOR COLOR	SCHEMATIC
<b>PTS635SL43</b>	130 g	0.169 (4,3)	Black	 SPST
<b>PTS635SL50</b>	130 g	0.197 (5,0)	Black	
<b>PTS635SH43</b>	200 g	0.169 (4,3)	Gray	
<b>PTS635SH50</b>	200 g	0.197 (5,0)	Gray	

### PC MOUNTING

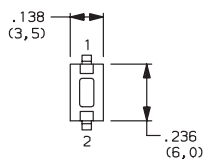
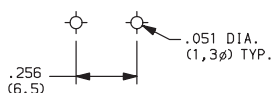

PTS635SL43  
SPST

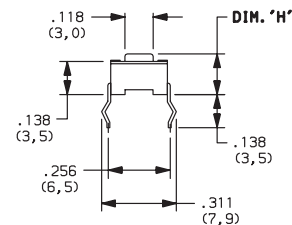
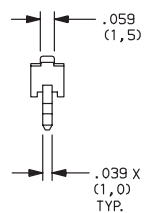

# C&K PTS Series Subminiature Tactile Switches

## 6 x 3.6mm Surface Mount Models



PTS635SL43SM  
SPST

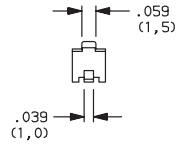
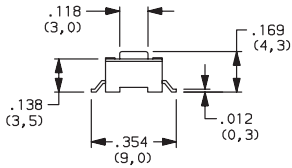
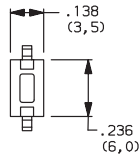

PART NUMBER	OPERATING FORCE (TYP.)	ACTUATOR COLOR	SCHEMATIC
PTS635SL43SM	130 g	Black	
PTS635SH43SM	200 g		

### PC MOUNTING

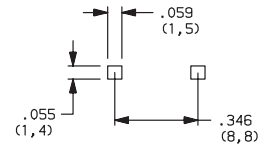

## 6.1 x 3.7mm Surface Mount Models



PTS635SL25SM  
SPST

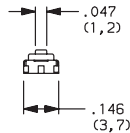
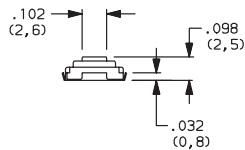
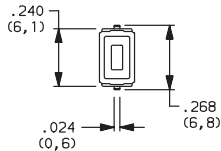

PART NUMBER	OPERATING FORCE (TYP.)	ACTUATOR COLOR	SCHEMATIC
PTS635SL25SM	130 g	Black	
PTS635SK25SM	260 g	Red	

NOTE: Add suffix 'TR' to part number for tape and reel packaging.

### PC MOUNTING

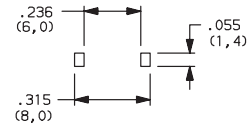

### TAPE & REEL PACKAGING

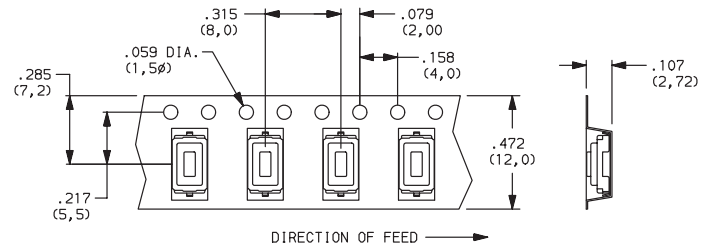

## 6 x 6mm Right Angle Models



PTS645VJL61  
SPST

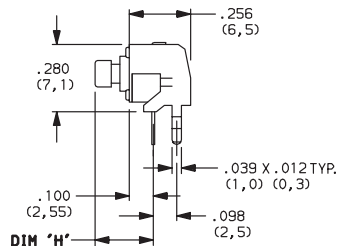
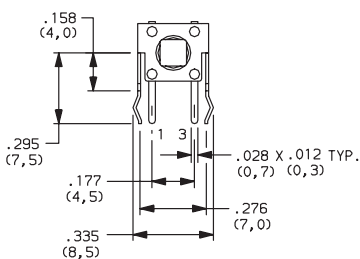
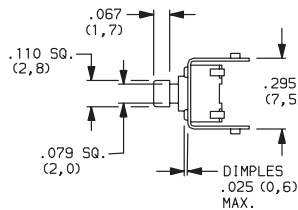

PART NUMBER (With ESD Pin)	OPERATING FORCE (TYP.)	DIM. 'H'	ACTUATOR COLOR	SCHEMATIC
PTS645VJL61	130 g	0.242 (6,15)	Black	
PTS645VJH61	200 g	0.242 (6,15)	Gray	

NOTE: 160 g version available; to specify part number, replace 'L' or 'H' with 'M'; actuator color is blue. 260 g version available; to specify part number, replace 'L' or 'H' with 'K'; actuator color is red.

### PC MOUNTING

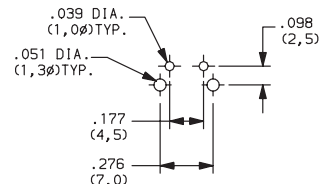

# C&K PTS Series Subminiature Tactile Switches

## 6 x 6 mm Models

PART NUMBER	PART NUMBER (With ESD Pin)	OPERATING FORCE (TYP.)	DIM. 'H'	ACTUATOR COLOR	FIG.	SCHEMATIC (With ESD Pin)	SCHEMATIC
PTS645SL43	PTS645TL43	130 g	0.169 (4,3)	Black	A		
PTS645SL50	PTS645TL50	130 g	0.197 (5,0)	Black	A		
PTS645SL70	PTS645TL70	130 g	0.275 (7,0)	Black	B		
PTS645SL95	PTS645TL95	130 g	0.374 (9,5)	Black	C		
PTS645SH43	PTS645TH43	200 g	0.169 (4,3)	Gray	A		
PTS645SH50	PTS645TH50	200 g	0.197 (5,0)	Gray	A		
PTS645SH70	PTS645TH70	200 g	0.275 (7,0)	Gray	B		
PTS645SH95	PTS645TH95	200 g	0.374 (9,5)	Gray	C		

NOTE: 160 g version available; to specify part number, replace 'L' or 'H' with 'M'; actuator color is blue. 260 g version available; to specify part number, replace 'L' or 'H' with 'K'; actuator color is red.



PTS645TL43  
SPST

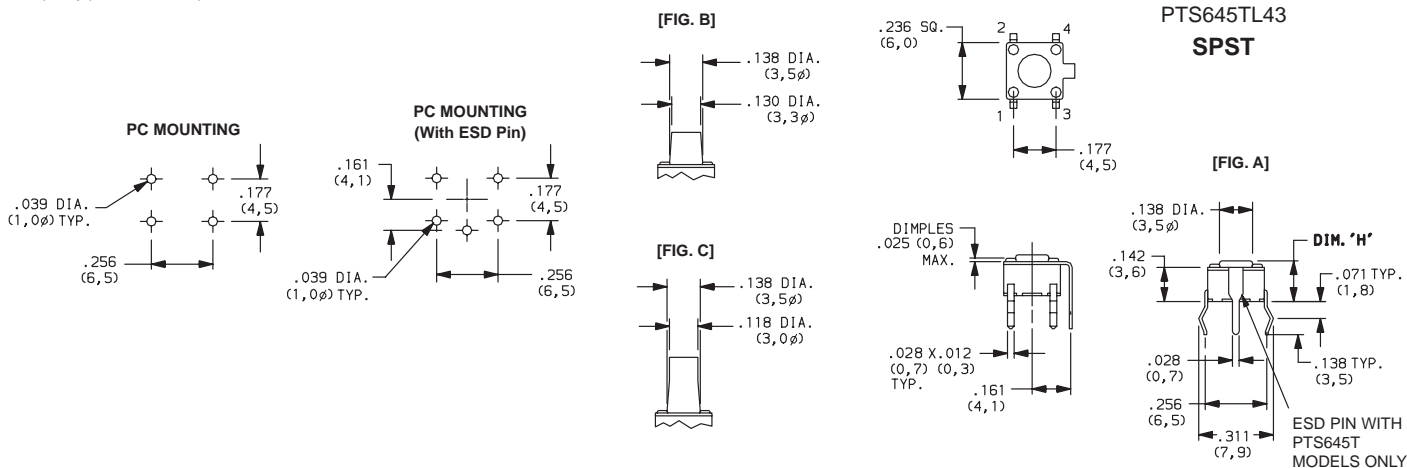

## 6 x 6 mm Models Right Angle Models

PART NUMBER	OPERATING FORCE (TYP.)	DIM. 'H'	ACTUATOR COLOR	FIG.	SCHEMATIC
PTS645VL31	130 g	0.124 (3,15)	Black	A	
PTS645VL39	130 g	0.151 (3,85)	Black	A	
PTS645VL58	130 g	0.230 (5,85)	Black	B	
PTS645VL83	130 g	0.329 (8,35)	Black	C	
PTS645VL15	130 g	0.624 (15,85)	Black	D	
PTS645VH31	200 g	0.124 (3,15)	Gray	A	
PTS645VH39	200 g	0.151 (3,85)	Gray	A	
PTS645VH58	200 g	0.230 (5,85)	Gray	B	
PTS645VH83	200 g	0.329 (8,35)	Gray	C	
PTS645VH15	200 g	0.624 (15,85)	Gray	D	

NOTE: 160 g version available; to specify part number, replace 'L' or 'H' with 'M'; actuator color is blue. 260 g version available; to specify part number, replace 'L' or 'H' with 'K'; actuator color is red.

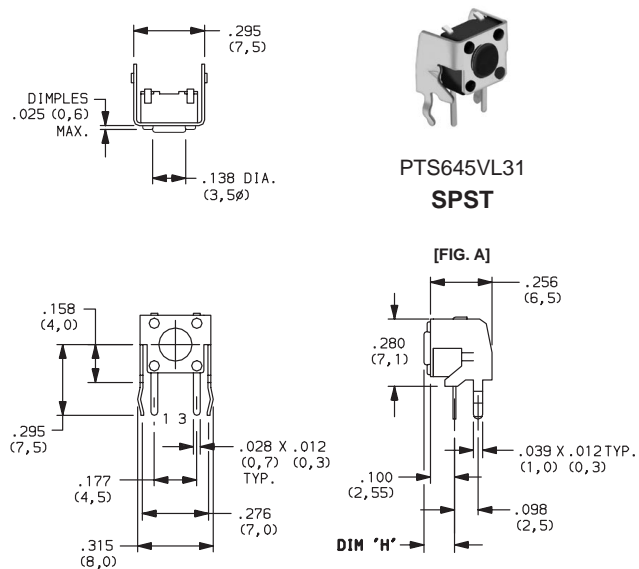

PTS645VL31  
SPST

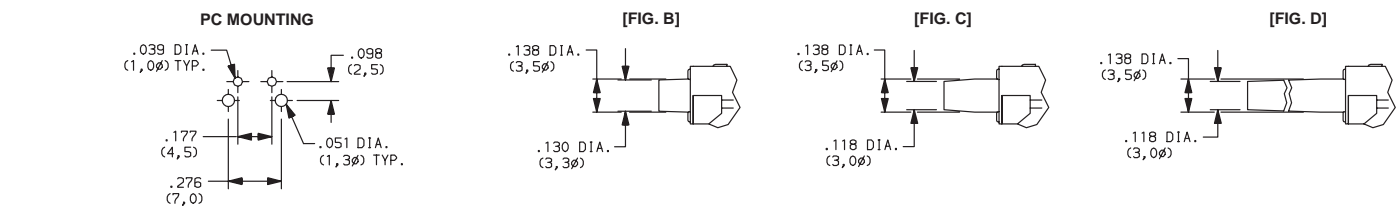

# C&K PTS Series Subminiature Tactile Switches

## 6 x 6mm Models

PART NUMBER	PART NUMBER (With ESD Pin)	OPERATING FORCE (TYP.)	DIM. 'H'	ACTUATOR COLOR	SCHEMATIC (With ESD Pin)	SCHEMATIC
<b>PTS645SJL73</b>	<b>PTS645TJL73</b>	130 g	0.287 (7,3)	Black		
<b>PTS645SJH73</b>	<b>PTS645TJH73</b>	200 g	0.287 (7,3)	Gray		

**NOTE:** 160 g version available. To specify part number, replace 'L' or 'H' with 'M'. Actuator color is blue. 260 g version available. To specify part number, replace 'L' or 'H' with 'K'. Actuator color is red.



PTS645TJL73  
SPST

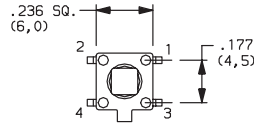

PC MOUNTING  
(With ESD Pin)

PC MOUNTING

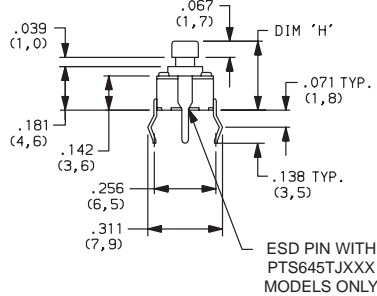
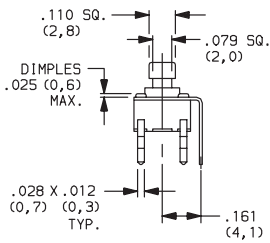
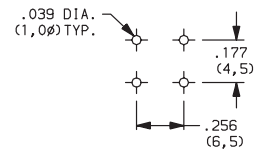
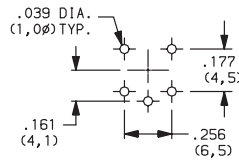

## 6 x 6mm Models



PTS645SL43TR  
SPST

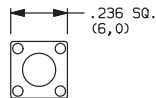

PART NUMBER	OPERATING FORCE (TYP.)	DIM. 'H'	ACTUATOR COLOR
<b>PTS645SL43TR</b>	130 g	0.169 (4,3)	Black
<b>PTS645SL50TR</b>	130 g	0.197 (5,0)	Black
<b>PTS645SL70TR</b>	130 g	0.275 (7,0)	Black
<b>PTS645SL95TR</b>	130 g	0.374 (9,5)	Black

TAPE & REEL PACKAGING

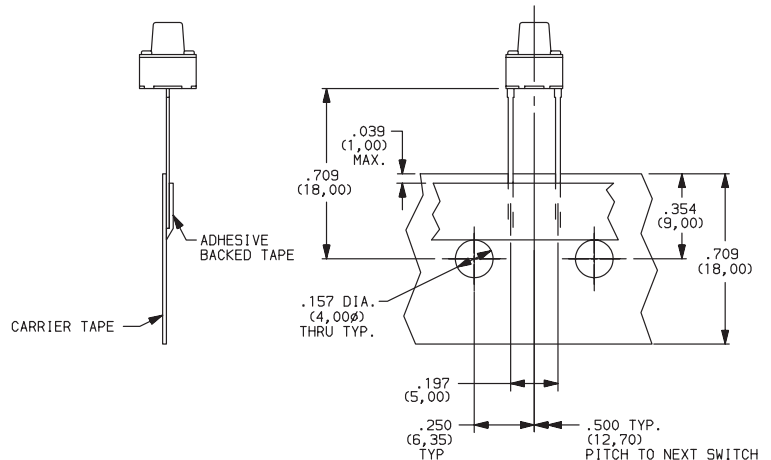
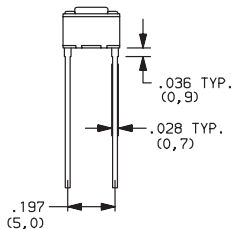
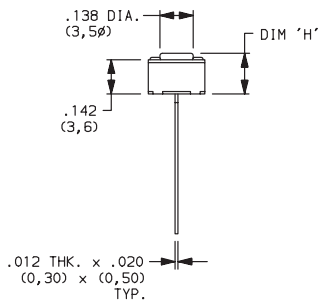

# C&K PTS Series Subminiature Tactile Switches

## 6 x 6mm Surface Mount Models

PART NUMBER	OPERATING FORCE (TYP.)	ACTUATOR COLOR	SCHEMATIC
<b>PTS645SL43SM</b>	130 g	Black	
<b>PTS645SH43SM</b>	200 g		

NOTE: Add suffix 'TR' to part number for tape and reel packaging.

### TAPE & REEL PACKAGING

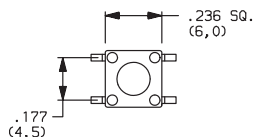
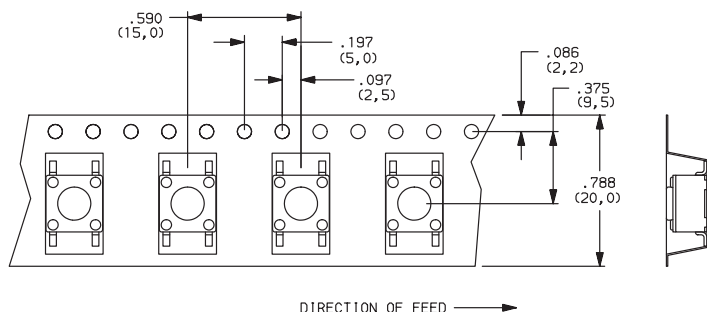

PTS645SL43SM  
SPST

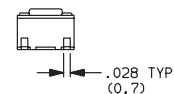
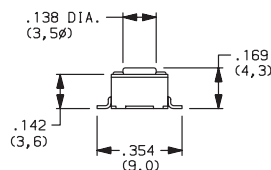

### PC MOUNTING

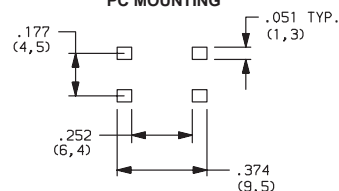

## 12 x 12mm Right Angle Models

PART NUMBER	OPERATING FORCE (TYP.)	ACTUATOR COLOR	SCHEMATIC
<b>PTS125VJM73</b>	160 g	Gray	
<b>PTS125VJK73</b>	260 g	Red	

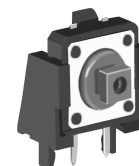
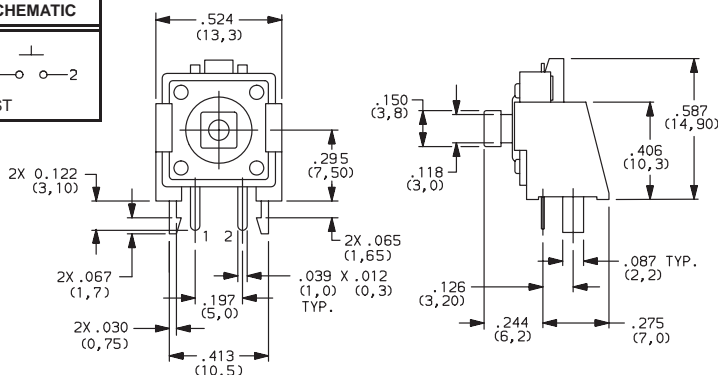
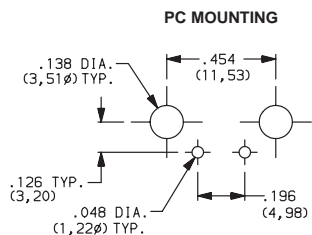

PTS125VJM73  
SPST

## 12 x 12mm Models

PART NUMBER	OPERATING FORCE (TYP.)	DIM. 'H'	ACTUATOR COLOR	SCHEMATIC
<b>PTS125SM12</b>	160 g	0.472 (12,0)	Gray	
<b>PTS125SK12</b>	260 g	0.472 (12,0)	Red	

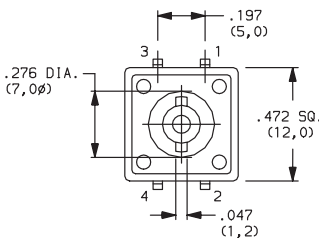
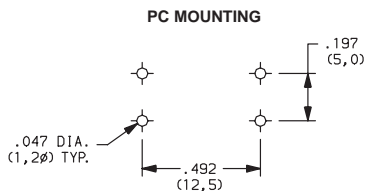

PTS125SM12  
SPST

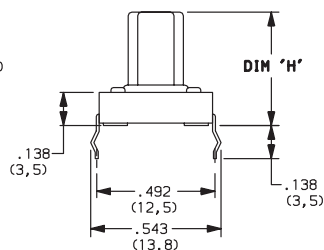
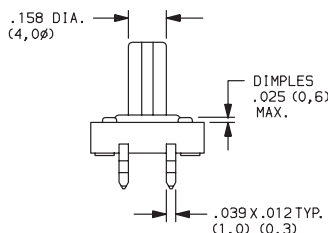

# C&K PTS Series Subminiature Tactile Switches

## 12 x 12mm Models



PTS125SM43  
SPST

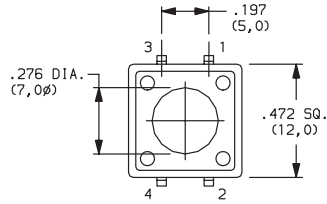

PART NUMBER	OPERATING FORCE (TYP.)	DIM. 'H'	ACTUATOR COLOR	SCHEMATIC
PTS125SM43	160 g	0.169 (4,3)	Gray	
PTS125SK43	260 g	0.169 (4,3)	Red	

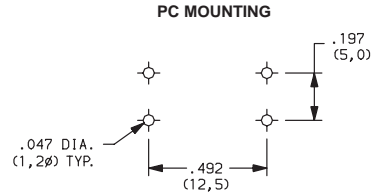
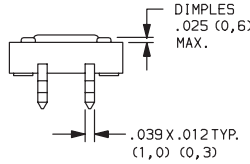
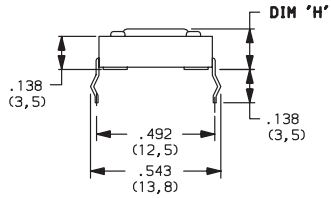

## 12 x 12mm Models



PTS125SM85  
SPST

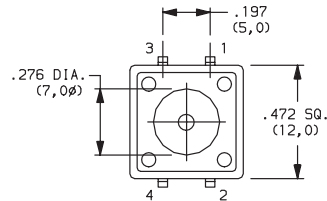

PART NUMBER	OPERATING FORCE (TYP.)	DIM. 'H'	ACTUATOR COLOR	SCHEMATIC
PTS125SM85	160 g	0.335 (8,5)	Black	
PTS125SK85	260 g	0.335 (8,5)	Red	

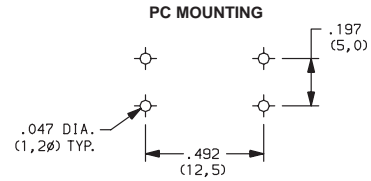
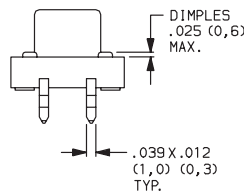
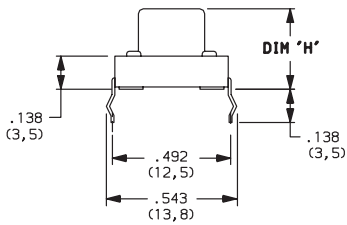

## 12 x 12mm Models



PTS125SJM73  
SPST

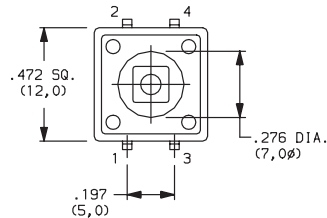

PART NUMBER	OPERATING FORCE (TYP.)	DIM. 'H'	ACTUATOR COLOR	SCHEMATIC
PTS125SJM73	160 g	0.287 (7,3)	Gray	
PTS125SJK73	260 g	0.287 (7,3)	Red	

