

CHIP COIL (CHIP INDUCTORS) LQW18AS□□□□0ZD

Murata Standard Reference Specification 【AEC-Q200】

1.Scope

This reference specification applies to LQW18AS_0ZD series, Chip coil(Chip Inductors) for automotive Electronics based on AEC-Q200 except for Power train and Safety.

2.Part Numbering

(ex)	LQ	W	18	A	S	1N6	J	0	Z	D
	Product ID	Structure	Dimension (L×W)	Applications and Characteristics	Category	Inductance	Tolerance	Features	Application Z:Automotive	Packaging D:Taping

3.Rating

- Operating Temperature Range. -40°C to $+125^{\circ}\text{C}$
- Storage Temperature Range. -40°C to $+125^{\circ}\text{C}$

Customer Part Number	MURATA Part Number	Inductance		Q (min.)	DC Resistance (Ω max.)	Self Resonant Frequency (MHz min.)	Rated Current (mA)	ESD Rank 6: 25kV
		(nH)	Tolerance					
	LQW18AS1N6J0ZD	1.6	J:±5%	24	0.030	12500	700	6
	LQW18AS1N8J0ZD	1.8		16	0.045	12500	700	
	LQW18AS3N3G0ZD	3.3	G: ±2% J: ±5%	35	0.045	5900	700	
	LQW18AS3N3J0ZD							
	LQW18AS3N6G0ZD	3.6	G: ±2% J: ±5%	22	0.063	5900	700	
	LQW18AS3N6J0ZD							
	LQW18AS3N9G0ZD	3.9	G: ±2% J: ±5%	22	0.080	6900	700	
	LQW18AS3N9J0ZD							
	LQW18AS4N3G0ZD	4.3	G: ±2% J: ±5%	22	0.063	5900	700	
	LQW18AS4N3J0ZD							
	LQW18AS4N7G0ZD	4.7	G: ±2% J: ±5%	20	0.116	5800	700	
	LQW18AS4N7J0ZD							
	LQW18AS5N1G0ZD	5.1	G: ±2% J: ±5%	20	0.140	5700	700	
	LQW18AS5N1J0ZD							
	LQW18AS5N6G0ZD	5.6	G: ±2% J: ±5%	26	0.075	4760	700	
	LQW18AS5N6J0ZD							
	LQW18AS6N8G0ZD	6.8	G: ±2% J: ±5%	27	0.110	5800	700	
	LQW18AS6N8J0ZD							
	LQW18AS7N5G0ZD	7.5	G: ±2% J: ±5%	28	0.106	4800	700	
	LQW18AS7N5J0ZD							
	LQW18AS8N2G0ZD	8.2	G: ±2% J: ±5%	30	0.115	4200	700	
	LQW18AS8N2J0ZD							
	LQW18AS8N7G0ZD	8.7	G: ±2% J: ±5%	28	0.109	4600	700	
	LQW18AS8N7J0ZD							
	LQW18AS9N5G0ZD	9.5	G: ±2% J: ±5%	28	0.135	5400	700	
	LQW18AS9N5J0ZD							
	LQW18AS10NG0ZD	10	G: ±2% J: ±5%	31	0.130	4800	700	
	LQW18AS10NJ0ZD							
	LQW18AS11NG0ZD	11	G: ±2% J: ±5%	30	0.086	4000	700	
	LQW18AS11NJ0ZD							
	LQW18AS12NG0ZD	12	G: ±2% J: ±5%	35	0.130	4000	700	
	LQW18AS12NJ0ZD							
	LQW18AS15NG0ZD	15	G: ±2% J: ±5%	35	0.170	4000	700	
	LQW18AS15NJ0ZD							
	LQW18AS16NG0ZD	16	G: ±2% J: ±5%	34	0.104	3300	700	
	LQW18AS16NJ0ZD							
	LQW18AS18NG0ZD	18	G: ±2% J: ±5%	35	0.170	3100	700	
	LQW18AS18NJ0ZD							
	LQW18AS22NG0ZD	22	G: ±2% J: ±5%	38	0.190	3000	700	
	LQW18AS22NJ0ZD							
	LQW18AS23NG0ZD	23	G: ±2% J: ±5%	38	0.190	2850	700	
	LQW18AS23NJ0ZD							
	LQW18AS24NG0ZD	24	G: ±2% J: ±5%	36	0.135	2650	700	
	LQW18AS24NJ0ZD							

Customer Part Number	MURATA Part Number	Inductance		Q (min.)	DC Resistance (Ω max.)	Self Resonant Frequency (MHz min.)	Rated Current (mA)	ESD Rank 6: 25kV
		(nH)	Tolerance					
	LQW18AS27NG0ZD LQW18AS27NJ0ZD	27	G: $\pm 2\%$ J: $\pm 5\%$	40	0.220	2800	600	6
	LQW18AS30NG0ZD LQW18AS30NJ0ZD	30		37	0.144	2250	600	
	LQW18AS33NG0ZD LQW18AS33NJ0ZD	33		40	0.220	2300	600	
	LQW18AS36NG0ZD LQW18AS36NJ0ZD	36		37	0.250	2080	600	
	LQW18AS39NG0ZD LQW18AS39NJ0ZD	39		40	0.250	2200	600	
	LQW18AS43NG0ZD LQW18AS43NJ0ZD	43		38	0.280	2000	600	
	LQW18AS47NG0ZD LQW18AS47NJ0ZD	47		38	0.280	2000	600	
	LQW18AS51NG0ZD LQW18AS51NJ0ZD	51		35	0.270	1900	600	
	LQW18AS56NG0ZD LQW18AS56NJ0ZD	56		38	0.310	1900	600	
	LQW18AS68NG0ZD LQW18AS68NJ0ZD	68		37	0.340	1700	600	
	LQW18AS72NG0ZD LQW18AS72NJ0ZD	72		34	0.490	1700	400	
	LQW18AS82NG0ZD LQW18AS82NJ0ZD	82		34	0.540	1700	400	
	LQW18ASR10G0ZD LQW18ASR10J0ZD	100		34	0.580	1400	400	
	LQW18ASR11G0ZD LQW18ASR11J0ZD	110		32	0.610	1350	300	
	LQW18ASR12G0ZD LQW18ASR12J0ZD	120		32	0.650	1300	300	
	LQW18ASR15G0ZD LQW18ASR15J0ZD	150		28	0.920	990	280	
	LQW18ASR18G0ZD LQW18ASR18J0ZD	180		25	1.250	990	240	
	LQW18ASR20G0ZD LQW18ASR20J0ZD	200		25	1.980	900	200	
	LQW18ASR21G0ZD LQW18ASR21J0ZD	210		27	2.060	895	200	
	LQW18ASR22G0ZD LQW18ASR22J0ZD	220		25	2.100	900	200	
	LQW18ASR25G0ZD LQW18ASR25J0ZD	250		25	3.550	822	120	
	LQW18ASR27G0ZD LQW18ASR27J0ZD	270		24	2.300	900	170	
	LQW18ASR33G0ZD LQW18ASR33J0ZD	330		25	3.890	900	100	
	LQW18ASR39G0ZD LQW18ASR39J0ZD	390		25	4.350	900	100	

(*1)

Standard Testing Conditions

《Unless otherwise specified》

Temperature : Ordinary Temperature / 15°C to 35°C
Humidity : Ordinary Humidity / 25%(RH) to 85%(RH)

《In case of doubt》

Temperature : 20°C \pm 2°C
Humidity : 60%(RH) to 70%(RH)
Atmospheric Pressure : 86kPa to 106 kPa

4. Appearance and Dimensions

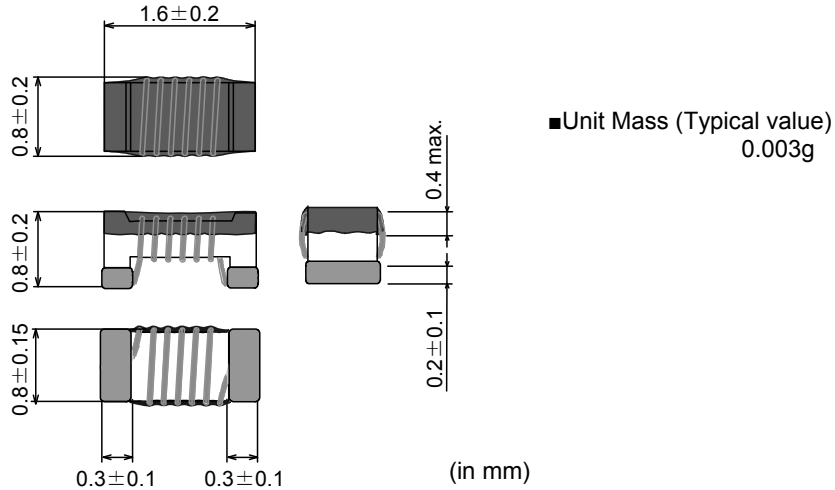

5. Electrical Performance

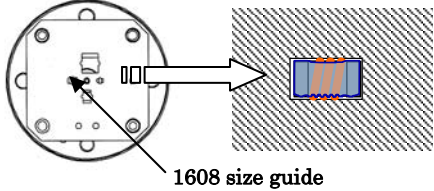
No.	Item	Specification	Test Method
5.1	Inductance	Inductance shall meet item 3.	Measuring Equipment: KEYSIGHT E4991A or equivalent Measuring Frequency: <Inductance> 250MHz/ 1.6nH~43nH 200MHz/ 47nH~68nH 150MHz/ 72nH~150nH 100MHz/ 180nH~390nH <Q> 250MHz/ 1.6nH~43nH 200MHz/ 47nH~68nH 150MHz/ 72nH~150nH 100MHz/ 180nH~390nH Measuring Condition: Test signal level / about 0dBm Electrode spaces / 1.0 mm Electrical length/ 10.0mm Measuring Fixture: KEYSIGHT 16197A Position coil under test as shown in below and contact coil with each terminal by adding weight.
5.2	Q	Q shall meet item 3.	 <p>1608 size guide</p> Measuring Method: See P.10 <Electrical Performance: Measuring Method of Inductance/Q>
5.3	DC Resistance	DC Resistance shall meet item 3.	Measuring Equipment: Digital multi meter
5.4	Self Resonant Frequency(S.R.F)	S.R.F shall meet item 3.	Measuring Equipment: KEYSIGHT N5230A or equivalent

6.Q200 Requirement**6.1.Performance (based on Table 5 for Magnetics(Inductors / Transformer)****AEC-Q200 Rev.D issued June 1. 2010**

AEC-Q200			Murata Specification / Deviation				
No	Stress	Test Method					
3	High Temperature Exposure	1000hours at 125 deg C Set for 24hours at room temperature, then measured.	Meet Table A after testing. <u>Table A</u> <table border="1"> <tr> <td>Appearance</td> <td>No damage</td> </tr> <tr> <td>Inductance 1.6nH~43nH (at 250MHz) 47nH~ 68nH (at 200MHz) 72nH~150nH (at 150MHz) 180nH~390nH (at 100MHz)</td> <td>Within ±5%</td> </tr> </table>	Appearance	No damage	Inductance 1.6nH~43nH (at 250MHz) 47nH~ 68nH (at 200MHz) 72nH~150nH (at 150MHz) 180nH~390nH (at 100MHz)	Within ±5%
Appearance	No damage						
Inductance 1.6nH~43nH (at 250MHz) 47nH~ 68nH (at 200MHz) 72nH~150nH (at 150MHz) 180nH~390nH (at 100MHz)	Within ±5%						
4	Temperature Cycling	1000cycles -40 deg C to +125 deg C Set for 24hours at room temperature, then measured.	Meet Table A after testing.				
7	Biased Humidity	1000hours at 85 deg C, 85%RH unpowered..	Meet Table A after testing.				
8	Operational Life	Apply Rated Current 125 deg C 1000hours Set for 24hours at room temperature, then measured	Meet Table A after testing.				
9	External Visual	Visual inspection	No abnormalities				
10	Physical Dimension	Meet ITEM 4 (Style and Dimensions)	No defects				
12	Resistance to Solvents	Per MIL-STD-202 Method 215	Not Applicable				
13	Mechanical Shock	Per MIL-STD-202 Method 213 Condition C : 100g's(0.98N), 6ms, Half sine, 12.3ft/s	Meet Table A after testing.				
14	Vibration	5g's(0.049N) for 20 minutes 12cycles each of 3 orientations Test from 10-2000Hz.	Meet Table A after testing.				
15	Resistance to Soldering Heat	No-heating Solder temperature 260C+/-5 deg C Immersion time 10s	Pre-heating: 150C +/-10 deg C, 60s to 90s Meet Table A after testing.				
17	ESD	Per AEC-Q200-002	ESD Rank: Refer to Item 3. Rating. Meet Table A after testing.				
18	Solderbility	Per J-STD-002	Method b : Not Applicable 95% of the terminations is to be soldered. (Except exposed wire)				
19	Electrical Characterization	Measured : Inductance	No defects				

AEC-Q200			Murata Specification / Deviation				
No	Stress	Test Method					
20	Flammability	Per UL-94	Not Applicable				
21	Board Flex	Epoxy-PCB(1.6mm) Deflection 2mm(min) Holding time 60s	Meet Table B after testing. <u>Table B</u> <table border="1" style="margin-left: 20px; border-collapse: collapse;"> <tr> <td style="padding: 2px;">Appearance</td> <td style="padding: 2px;">No damage</td> </tr> <tr> <td style="padding: 2px;">DC resistance change</td> <td style="padding: 2px;">Within ±10%</td> </tr> </table>	Appearance	No damage	DC resistance change	Within ±10%
Appearance	No damage						
DC resistance change	Within ±10%						
22	Terminal Strength	Per AEC-Q200-006 A force of 17.7N for 60s	Murata Deviation Request: 10N/5s No defect				

7.Specification of Packaging

7.1 Appearance and Dimensions of paper tape (8mm-wide)

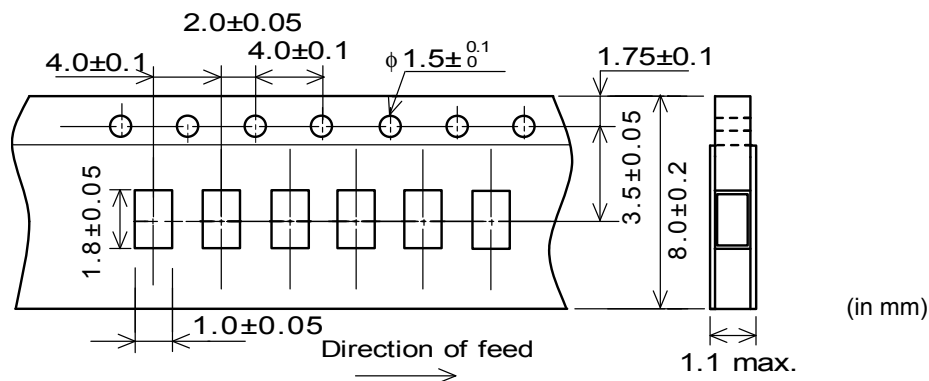

7.2 Specification of Taping

- (1) Packing quantity (standard quantity)
4,000 pcs. / reel
- (2) Packing Method
Products shall be packed in the cavity of the base tape and sealed by top tape and bottom tape.
- (3) Sprocket hole
The sprocket holes are to the right as the tape is pulled toward the user.
- (4) Spliced point
Base tape and Top tape has no spliced point.
- (5) Missing components number
Missing components number within 0.1 % of the number per reel or 1 pc., whichever is greater, and are not continuous. The Specified quantity per reel is kept.

7.3 Pull Strength

Top tape	5N min.
Bottom tape	

7.4 Peeling off force of cover tape

Speed of Peeling off	300mm/min
Peeling off force	0.1N to 0.6N (minimum value is typical)

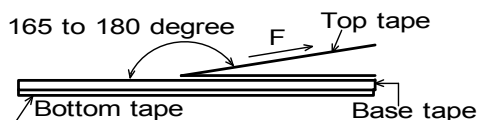

7.5 Dimensions of Leader-tape,Trailer and Reel

There shall be leader-tape (top tape and empty tape) and trailer-tape (empty tape) as follows.

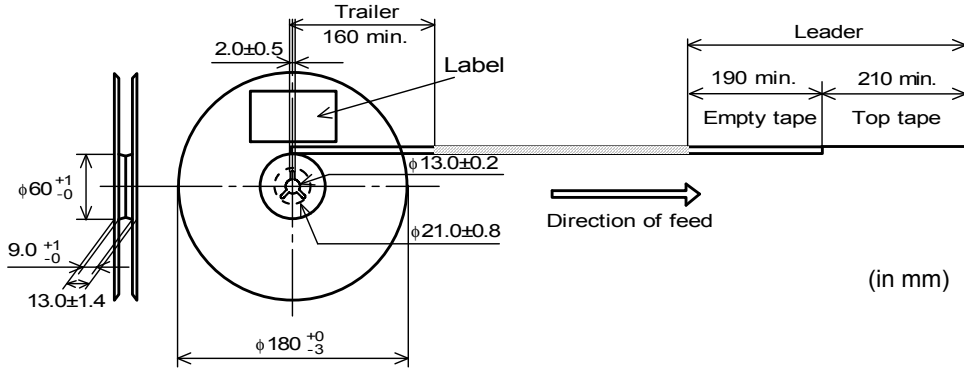

7.6 Marking for reel

Customer part number, MURATA part number, Inspection number(•1) ,RoHS Marking(•2), Quantity etc ...

•1) <Expression of Inspection No.>

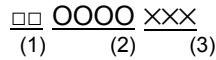

- (1) Factory code
- (2) Date First digit : Year / Last digit of year
 Second digit : Month / Jan. to Sep. • 1 to 9, Oct. to Dec. • O,N,D
 Third, Fourth digit : Day
- (3) Serial No.

•2) <Expression of RoHS Marking>

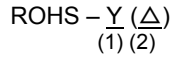

- (1) RoHS regulation conformity parts.
- (2) MURATA classification number

7.7 Marking for Outside package (corrugated paper box)

Customer name, Purchasing order number, Customer part number, MURATA part number, RoHS Marking(•2) ,Quantity, etc ...

7.8. Specification of Outer Case

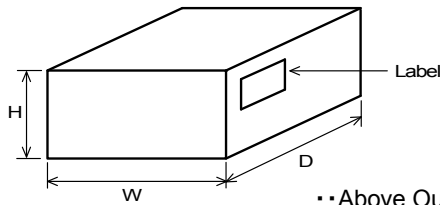

Outer Case Dimensions (mm)			Standard Reel Quantity in Outer Case (Reel)
W	D	H	
186	186	93	5

• Above Outer Case size is typical. It depends on a quantity of an order.

8. ⚠ Caution

8.1 Caution(Rating)

Do not exceed maximum rated current of the product. Thermal stress may be transmitted to the product and short/open circuit of the product or falling off the product may be occurred.

8.2 Fail-safe

Be sure to provide an appropriate fail-safe function on your product to prevent a second damage that may be caused by the abnormal function or the failure of our product.

8.3 Limitation of Applications

Please contact us before using our products for the applications listed below which require especially high reliability for the prevention of defects which might directly cause damage to the third party's life, body or property.

- | | |
|-----------------------------------|------------------------------------------------------------------------------------------------------------------|
| (1) Aircraft equipment | (6) Transportation equipment (trains, ships, etc.) |
| (2) Aerospace equipment | (7) Traffic signal equipment |
| (3) Undersea equipment | (8) Disaster prevention / crime prevention equipment |
| (4) Power plant control equipment | (9) Data-processing equipment |
| (5) Medical equipment | (10) Applications of similar complexity and /or reliability requirements to the applications listed in the above |

9. Notice

Products can only be soldered with reflow.
 This product is designed for solder mounting.
 Please consult us in advance for applying other mounting method such as conductive adhesive.

9.1 Land pattern designing

Recommended land patterns for reflow soldering are as follows:
 These have been designed for Electric characteristics and solderability.
 Please follow the recommended patterns. Otherwise, their performance which includes electrical performance or solderability may be affected, or result to "position shift" in soldering process.

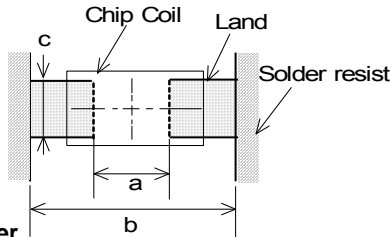

a	0.6 to 0.8
b	1.9 to 2.0
c	0.7 to 1.0

(in mm)

9.2 Flux, Solder

- Use rosin-based flux.
 Includes middle activator equivalent to 0.06(wt)% to 0.1(wt)% Chlorine.
 Don't use highly acidic flux with halide content exceeding 0.2(wt)% (chlorine conversion value).
 Don't use water-soluble flux.
- Use Sn-3.0Ag-0.5Cu solder.
- Standard thickness of solder paste : 100µm to 150µm.

9.3 Reflow soldering conditions

- Pre-heating should be in such a way that the temperature difference between solder and product surface is limited to 150°C max. Cooling into solvent after soldering also should be in such a way that the temperature difference is limited to 100°C max.
 Insufficient pre-heating may cause cracks on the product, resulting in the deterioration of products quality.
- Standard soldering profile and the limit soldering profile is as follows.
 The excessive limit soldering conditions may cause leaching of the electrode and / or resulting in the deterioration of product quality.
- Reflow soldering profile

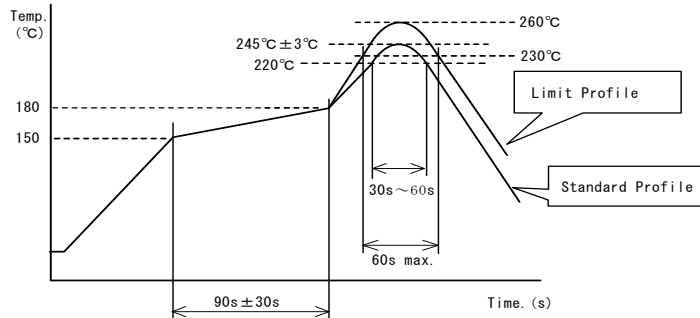

	Standard Profile	Limit Profile
Pre-heating	150°C~180°C、90s±30s	
Heating	above 220°C、30s~60s	above 230°C、60s max.
Peak temperature	245°C±3°C	260°C、10s
Cycle of reflow	2 times	

9.4 Reworking with soldering iron

The following conditions must be strictly followed when using a soldering iron.

Pre-heating	150°C,1 min
Tip temperature	350°C max.
Soldering iron output	80W max.
Tip diameter	φ3mm max.
Soldering time	3(+1,-0)s
Time	2 times

Note :Do not directly touch the products with the tip of the soldering iron in order to prevent the crack on the products due to the thermal shock.

9.5 Solder Volume

- Solder shall be used not to be exceeded the upper limits as shown below.
- Accordingly increasing the solder volume, the mechanical stress to Chip is also increased. Exceeding solder volume may cause the failure of mechanical or electrical performance.

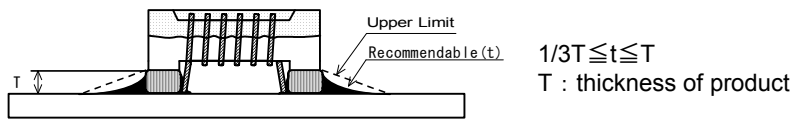

9.6 Product's location

The following shall be considered when designing and laying out P.C.B.'s.

- (1) P.C.B. shall be designed so that products are not subject to the mechanical stress due to warping the board.

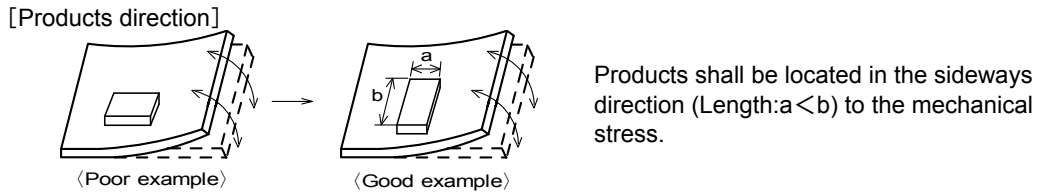

- (2) Products location on P.C.B. separation

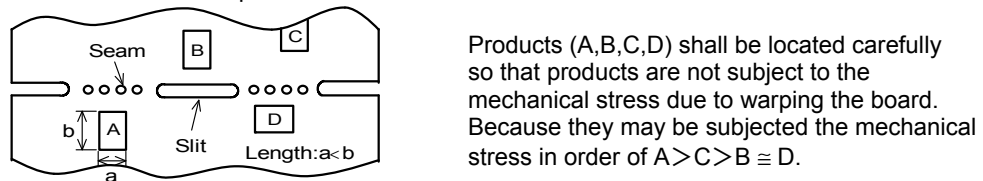

9.7 Cleaning Conditions

Products shall be cleaned on the following conditions.

- (1) Cleaning temperature shall be limited to 60°C max.(40°C max for IPA)
- (2) Ultrasonic cleaning shall comply with the following conditions with avoiding the resonance phenomenon at the mounted products and P.C.B.
Power : 20 W / l max. Frequency : 28kHz to 40kHz Time : 5 min max.
- (3) Cleaner
 1. Alcohol type cleaner
Isopropyl alcohol (IPA)
 2. Aqueous agent
PINE ALPHA ST-100S
- (4) There shall be no residual flux and residual cleaner after cleaning.
In the case of using aqueous agent, products shall be dried completely after rinse with de-ionized water in order to remove the cleaner.
- (5) Other cleaning Please contact us.

9.8 Resin coating

The inductance value may change due to high cure-stress of resin to be used for coating/molding products. An open circuit issue may occur by mechanical stress caused by the resin, amount/cured shape of resin, or operating condition etc. Some resin contains some impurities or chloride possible to generate chlorine by hydrolysis under some operating condition may cause corrosion of wire of coil, leading to open circuit. So, please pay your careful attention when you select resin in case of coating/molding the products with the resin.

Prior to use the coating resin, please make sure no reliability issue is observed by evaluating products mounted on your board.

9.9 Caution for use

- Sharp material such as a pair of tweezers or other material such as bristles of cleaning brush , shall not be touched to the winding portion to prevent the breaking of wire.
- Mechanical shock should not be applied to the products mounted on the board to prevent the breaking of the core.

9.10 Notice of product handling at mounting

In some mounting machines,when picking up components support pin pushes up the components from the bottom of base tape. In this case, please remove the support pin. The support pin may damage the components and break wire.

In rare case ,the laser recognition can not recognize this component. Please contact us when you use laser recognition. (There is no problem with the permeation and reflection type.)

9.11 Handling of a substrate

After mounting products on a substrate, do not apply any stress to the product caused by bending or twisting to the substrate when cropping the substrate, inserting and removing a connector from the substrate or tightening screw to the substrate.

Excessive mechanical stress may cause cracking in the product.

Bending

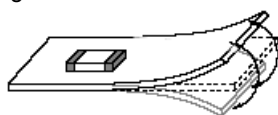

Twisting

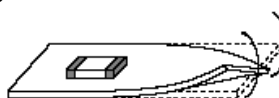

9.12 Storage and Handling Requirements

(1) Storage period

Use the products within 12 months after delivered.
Solderability should be checked if this period is exceeded.

(2) Storage conditions

- Products should be stored in the warehouse on the following conditions.
 - Temperature : -10°C to 40°C
 - Humidity : 15% to 85% relative humidity No rapid change on temperature and humidity
- Don't keep products in corrosive gases such as sulfur, chlorine gas or acid, or it may cause oxidization of electrode, resulting in poor solderability.
- Products should not be stored on bulk packaging condition to prevent the chipping of the core and the breaking of winding wire caused by the collision between the products.
- Products should be stored on the palette for the prevention of the influence from humidity, dust and so on.
- Products should be stored in the warehouse without heat shock, vibration, direct sunlight and so on.

(3) Handling Condition

Care should be taken when transporting or handling product to avoid excessive vibration or mechanical shock.

10. ⚠ Note

- (1) Please make sure that your product has been evaluated in view of your specifications with our product being mounted to your product.
- (2) You are requested not to use our product deviating from the reference specifications.
- (3) The contents of this reference specification are subject to change without advance notice.
Please approve our product specifications or transact the approval sheet for product specifications before ordering.

<Electrical Performance: Measuring Method of Inductance / Q>

To keep compatibility to other vender's product, Inductance and Q value shall be measured in following method.

(1) Residual elements and stray elements of test fixture can be described by F-parameter shown in following.

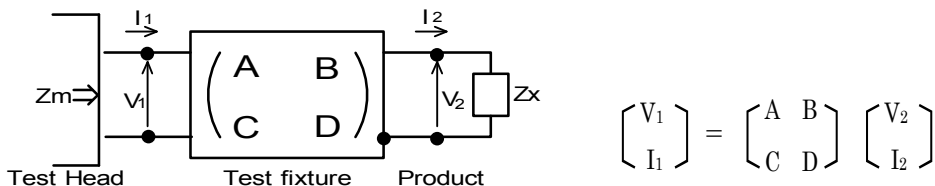

(2) The impedance of chip coil Zx and measured value Zm can be described by input/output current/voltage.

$$Z_m = \frac{V_1}{I_1} \quad , \quad Z_x = \frac{V_2}{I_2}$$

(3) Thus, the relation between Zx and Zm is followin

$$Z_x = \alpha \frac{Z_m - \beta}{1 - Z_m \Gamma}$$

Where, $\alpha = D/A = 1$
 $\beta = B/D = Z_{sm} - (1 - Y_{om} Z_{sm}) Z_{ss}$
 $\Gamma = C/A = Y_{om}$

Z_{sm} : measured impedance of short chip
 Z_{ss} : residual impedance of short chip (=equivalent series Inductance X)
 Y_{om} : measured admittance when opening the fixture

Important: X: Zss shall be defined as correction value to fit nominal inductance of other venders' products.
Please input X value instead of equivalent series Inductance (ShortL) on test equipment calibration.

(4) Lx and Qx shall be calculated with the following equation.

$$L_x = \frac{\text{Im}(Z_x)}{2\pi f} \quad , \quad Q_x = \frac{\text{Im}(Z_x)}{\text{Re}(Z_x)} \quad f : \text{Measuring frequency}$$

Inductance and Q value shall be measured after this calibration setting.
In addition, Q value should be measured under our standard calibration setting of residual impedance, 0.771nH.

Chart. Equivalent series Inductance to fit nominal inductance of other vendors' products.

MURATA Part Number	Inductance		Q	
	X [nH] equivalent seriesInductance	Measuring Frequency	Short bar correction value [nH]	Measuring Frequency
LQW18AS1N6_0Z	0.131	250	0.771	250
LQW18AS1N8_0Z	0.061	250		250
LQW18AS3N3_0Z	0.111	250		250
LQW18AS3N6_0Z	0.231	250		250
LQW18AS3N9_0Z	0.011	250		250
LQW18AS4N3_0Z	0.251	250		250
LQW18AS4N7_0Z	0.301	250		250
LQW18AS5N1_0Z	0.071	250		250
LQW18AS5N6_0Z	-0.079	250		250
LQW18AS6N8_0Z	-0.019	250		250
LQW18AS7N5_0Z	0.201	250		250
LQW18AS8N2_0Z	0.281	250		250
LQW18AS8N7_0Z	0.221	250		250
LQW18AS9N5_0Z	0.021	250		250
LQW18AS10N_0Z	-0.089	250		250
LQW18AS11N_0Z	0.321	250		250
LQW18AS12N_0Z	-0.189	250		250
LQW18AS15N_0Z	-0.369	250		250
LQW18AS16N_0Z	0.271	250		250
LQW18AS18N_0Z	-0.429	250		250
LQW18AS22N_0Z	-0.419	250		250
LQW18AS23N_0Z	-0.509	250		250
LQW18AS24N_0Z	0.401	250		250
LQW18AS27N_0Z	0.171	250		250
LQW18AS30N_0Z	-0.219	250		250
LQW18AS33N_0Z	-0.589	250		250
LQW18AS36N_0Z	-0.299	250		250
LQW18AS39N_0Z	-0.859	250		250
LQW18AS43N_0Z	0.231	250		250
LQW18AS47N_0Z	-0.769	200		200
LQW18AS51N_0Z	-0.949	200		200
LQW18AS56N_0Z	-1.299	200		200
LQW18AS68N_0Z	-1.739	200		200
LQW18AS72N_0Z	-1.089	150		150
LQW18AS82N_0Z	-1.909	150		150
LQW18ASR10_0Z	-1.729	150		150
LQW18ASR11_0Z	-2.829	150		150
LQW18ASR12_0Z	-3.429	150		150
LQW18ASR15_0Z	-4.429	150		150
LQW18ASR18_0Z	-5.129	100		100
LQW18ASR20_0Z	-4.629	100	100	
LQW18ASR21_0Z	-2.029	100	100	
LQW18ASR22_0Z	-5.229	100	100	
LQW18ASR25_0Z	-4.029	100	100	
LQW18ASR27_0Z	-4.329	100	100	
LQW18ASR33_0Z	-8.329	100	100	
LQW18ASR39_0Z	-13.329	100	100	