

SE1470

AlGaAs Infrared Emitting Diode

FEATURES

- Compact metal can coaxial package
- 24° (nominal) beam angle
- 880 nm wavelength
- Higher output power than GaAs at equivalent drive currents
- Wide operating temperature range (-55°C to +125°C)
- Mechanically and spectrally matched to SD1420 photodiode, SD1440 phototransistor and SD1410 photodarlington

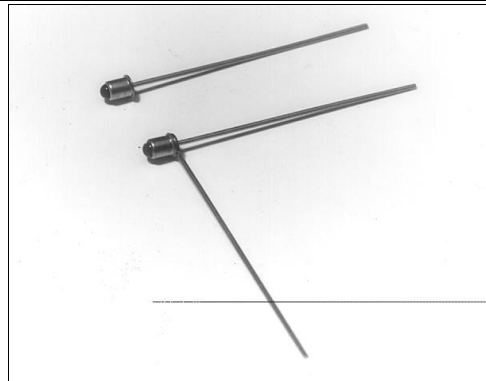

INFRA-63.TIF

DESCRIPTION

The SE1470 is a high intensity aluminum gallium arsenide infrared emitting diode mounted in a glass lensed metal can coaxial package. The package may have a tab or second lead welded to the can as an optional feature (SE1470-XXXL). Both leads are flexible and may be formed as required to fit various mounting configurations. These devices typically exhibit 70% greater power intensity than gallium arsenide devices at the same forward current.

OUTLINE DIMENSIONS in inches (mm)

Tolerance 3 plc decimals ±0.005(0.12)
2 plc decimals ±0.020(0.51)

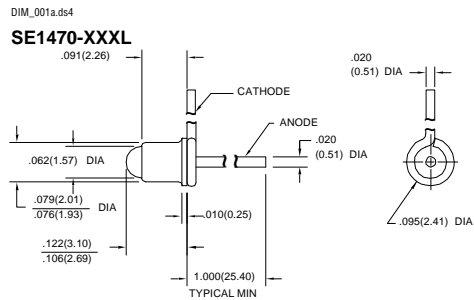
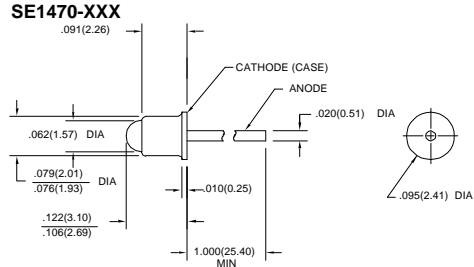

DIM_001b.ds4

SE1470

AlGaAs Infrared Emitting Diode

ELECTRICAL CHARACTERISTICS (25°C unless otherwise noted)

PARAMETER	SYMBOL	MIN	TYP	MAX	UNITS	TEST CONDITIONS
Irradiance ⁽¹⁾	H				mW/cm ²	I _F =20 mA
SE1470-001, SE1470-001 L		0.35				
SE1470-002, SE1470-002 L		0.65				
SE1470-003, SE1470-003 L		1.10	4.5			
SE1470-004, SE1470-004 L		1.65				
Forward Voltage	V _F			1.8	V	I _F =50 mA
Reverse Breakdown Voltage	V _{BR}	3.0			V	I _R =10 μA
Peak Output Wavelength	λ _p		880		nm	
Spectral Bandwidth	Δλ		80		nm	
Spectral Shift With Temperature	Δλ _p /ΔT		0.2		nm/°C	
Beam Angle ⁽²⁾	∅		24		degr.	I _F =Constant
Radiation Rise And Fall Time	t _r , t _f		0.7		μs	

Notes

1. Measured in mW/cm² into a 0.104 (2.64) diameter aperture placed 0.535(13.6) from the lens tip.
2. Beam angle is defined as the total included angle between the half intensity points.

ABSOLUTE MAXIMUM RATINGS

(25°C Free-Air Temperature unless otherwise noted)

Continuous Forward Current	50 mA
Power Dissipation	75 mW ⁽¹⁾
Operating Temperature Range	-55°C to 125°C
Storage Temperature Range	-65°C to 150°C
Soldering Temperature (10 sec)	260°C

Notes

1. Derate linearly from 25°C free-air temperature at the rate of 0.71 mW/°C.

SCHEMATIC



Honeywell reserves the right to make changes in order to improve design and supply the best products possible.

Honeywell

SE1470

AlGaAs Infrared Emitting Diode

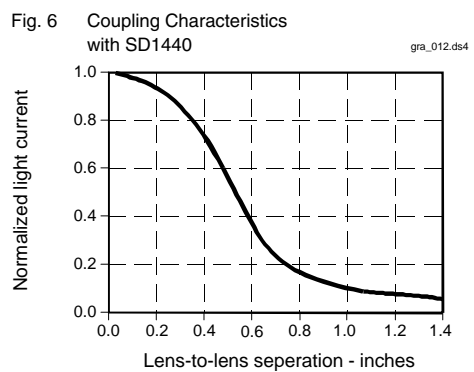
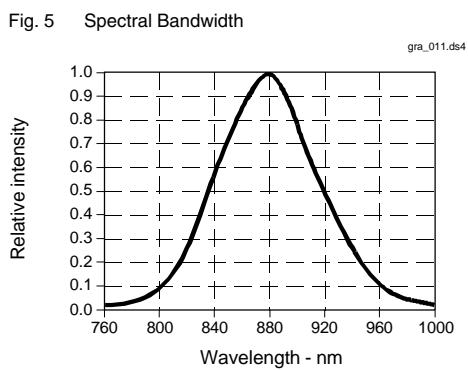
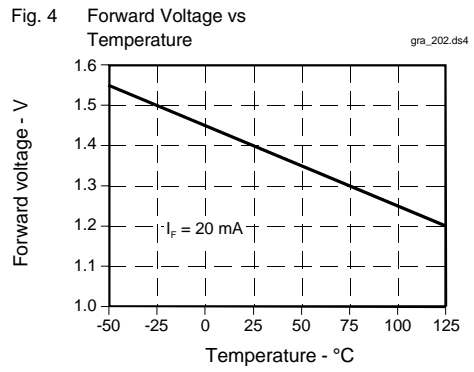
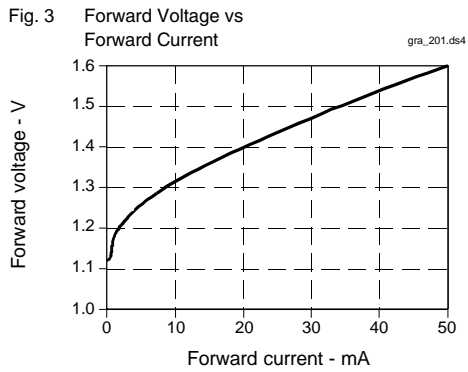
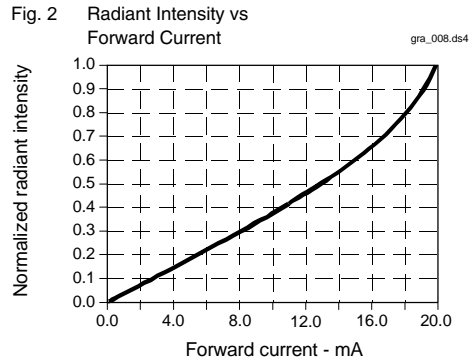
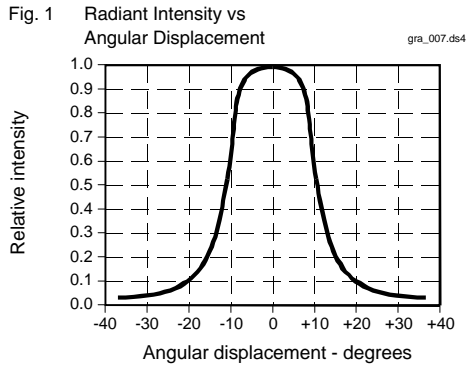

SE1470

AlGaAs Infrared Emitting Diode

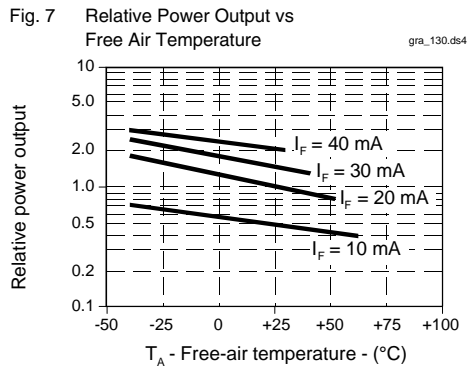

All Performance Curves Show Typical Values