



Power Supply in Harsh Environments

Contacts designed to be used in severe environments. Resistant to fluids, high shock and vibration.

- A wide range** ■ All shell materials and platings: from composite to stainless steel.
Hermetic version available.
- Contact performance** ■ High current: 20% more intensity compared to standard contacts.
#4 contact: 80A typical, #8 contact: 45A typical.
High vibration and temperature level.
- Large choice of layouts** ■ 7 layouts with only #4 or only #8 contacts.
12 mixed layouts available with power contacts.
- User friendly** ■ Easy maintenance with removable contacts.
Bus bar termination available.





Description

- Quick screw coupling connector with removable crimp contact
- Shell available in aluminum, composite, Stainless steel, Titanium & Bronze
- Six layouts with different current rating
- Consult us for power hermetic version
- High Power offer available on demand
- Derating curves available for #4 and #8.

Technical features

Mechanical

- **Shell:** Aluminum alloy, Composite, Bronze, Stainless steel, Titanium
- **Plating:**
 - . Olive green cadmium (W/J)
 - . Nickel (F/M/TF/S)
 - . Without plating (X for composite, TT for titanium and JVS for Bronze)
 - . Passivated (K)
- **Grommet and seal:** Silicon elastomer
- **Insulator:** Thermoset
- **Contact body:** Copper Alloy
- **Contact retention:**
 - . #4 = 200N
 - . #8 = 111N
- **Shock:** 300g during 3ms
- **Endurance:** 500 mating / unmating operations
- **Vibration:** As per MIL DTL 38999

Electrical

- **Dielectric withstanding:** Test voltage rating (Vrms)

Service	Sea level	at 21 000 m
M	1 300	800
I	1 800	1 000

- **Insulation Resistance:** 5000 MΩ under 500 Vdc
- **Max current rating per contact:**
 - . #4 = 80A
 - . #8 = 45A
- **Contact resistance:**
 - . #4 = 2mΩ
 - . #8 = 3mΩ
- **Shielding:** As per MIL DTL 38999
- **Shell continuity:**
 - . W = 2.5 mΩ
 - . F = 1mΩ
 - . J, M = 3 mΩ
 - . JVS = 5 mΩ

Environmental

- **Temperature range:**
 - . W, J, X, JVS = - 65°C +175°C
 - . F, M, K, S, TT, TF = - 65°C +200°C
- **Sealing:** As per MIL DTL 38999
- **Damp Heat:** As per MIL DTL 38999
- **Salt Spray:**
 - . W, TT, TF, K, JVS = 500 hours
 - . F, S = 48 hours
 - . J, M, X = 2000 hours
- **Fire resistance:** As per EN 2591 - C 17 method A
- **Resistance to fluid:** As per MIL DTL 38999

Connector part numbers

Aluminum, Composite, Stainless steel & Titanium connector

Basic Series	8D	0	-	11	W	80	P	N	251
Style:									
0: Square flange receptacle									
5: Plug with RFI shielding									
7: Jam nut receptacle									
Type: Crimp contact									
Shell size: 11 - 17 - 19 - 21 - 23 - 25									
Plating:									
Aluminum shell:									
W: Olive drab cadmium									
F: Nickel									
ZC: Green zinc cobalt									
Z: Black zinc nickel									
Composite shell:									
J: Olive green cadmium									
M: Nickel									
X: Without plating									
Stainless steel shell:									
K: Corrosion resistant									
S: Nickel									
Titanium shell:									
TT: Without plating									
TF: Nickel									
Contact layouts: See next page									
Contact style:									
P: Pin contact A: Male connector supplied without contact									
S: Socket contact B: Female connector supplied without contact									
Orientation: N - A - B - C - D - E									
Specification:									
251: Mandatory for some layouts supplied with power contacts (see next page)									



Bronze connector



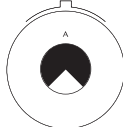
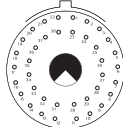
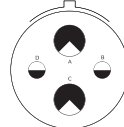
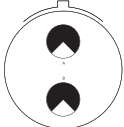
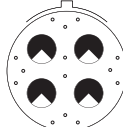

Basic Series	JVS	16	A	11	80	P	N	251
Style:								
00: Square flange receptacle								
07: Jam nut receptacle								
16: Plug								
Material:								
A: Bronze shell material								
Shell size: 11 - 17 - 19 - 21 - 23 - 25								
Contact layouts: See next page								
Contact style:								
P: Pin contact A: Male connector supplied without contact								
S: Socket contact B: Female connector supplied without contact								
Orientation: N - A - B - C - D - E								
Specification:								
251: Mandatory for some layouts supplied with power contacts (see next page)								

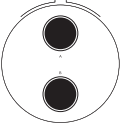
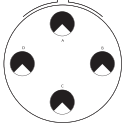
Contact layouts

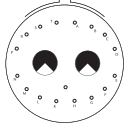
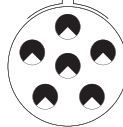
-  Contact #22D
-  Contact #12
-  Contact #20
-  Contact #8 Power
-  Contact #16
-  Contact #4 Power

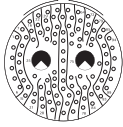
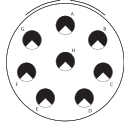
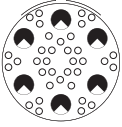
11				17			19
80 Spec 251	02 Spec 251	22 Spec 251	75 Spec 251			18 Spec 251	
							
1#8	38#22D 1#8	2#12 2#8	2#8			14#22D 4#8	

21						23	
20 Spec 251	42*	48*	72*	75 Spec 251	77 Spec 251	06 Spec 251	
							
18#20 2#8	2#4	4#8	6#16 2#4	4#8	17#22D 2#8	6#8	

25						
07 Spec 251	08 Spec 251	17 Spec 251	20 Spec 251	41 Spec 251	44*	46 Spec 251
						
97#22D 2#8	8#8	36 #22D 6 #8	10#20 13#16 4#12 3#8	22#22D, 3#20 11#16, 2#12 3#8	4#16 4#4	40#20 4#16 2#8

* Power contacts on standard, no spec. 251 needed.

Power contacts

Contact size	Contact type	Part number	Reducer	Cable size max.		Boot
				AWG	mm ²	
#4	Male	85997598900*	Without	N/A	25 mm ²	N/A not sealed
	Female	85997599900*				
	Male	85997534		AWG 4	16 to 21 mm ²	85994594 for cable 16mm ²
	Female	85997535				
	Male	85997524		AWG8	9 mm ²	N/A not sealed
	Female	85997525				
	Male	85997534	85932000A	AWG6	10 mm ²	85994593
	Female	85997535	Without	AWG6	10 mm ²	
	Male	85997528900				
	Female	85997529900				
#8	Male	85997580	Without	AWG8	9 mm ²	85994542
	Female	85997581				
	Male	85997580	85997645	AWG10	6 mm ²	85994547
	Female	85997581				
#8 according to EN 3155	Male	85996215900	Without	AWG8	9 mm ²	85994542
	Female	85996217900				
	Male	85996216900		AWG10	6 mm ²	85994547
	Female	85996218900				
#8 JVS only	Male	85997544	Without	AWG8	9 mm ²	85994542
	Female	85997541				
	Male	85997544	85997645	AWG10	6 mm ²	85994547
	Female	85997541				

Cable section AWG	#22	#20	#16	#12	#10	#8	#4
mm ² maxi	0.34	0.6	1.34	3.18	5.8	9	21
mm ² mini	0.095	0.21	0.6	1.91	3.8	5.8	16

* Not included in connector P/N. Must be ordered separately.

Bus bar contact

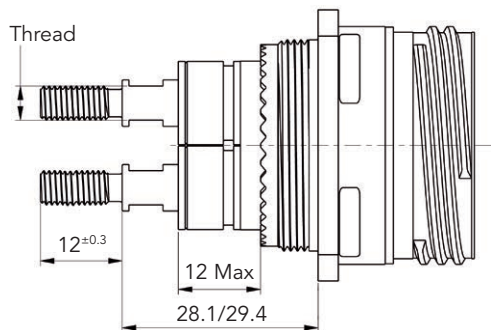

Contact size	Thread	Part number			Lug Ø
		Male	Female	Boots	
#4	M5x0.8	85930873A	85930875A	85994594	5.2
#8	M3x0.5	85930872A	85930874A	85994542	3.2

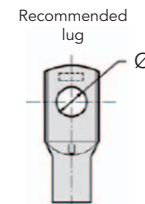

Contacts available separately only. Lug: tin over copper recommended. Dimensions for indication only.

Note: All dimensions are in millimeters (mm)

Power tools

Contact size	Contact type	Contact reference	Cable AWG	Crimping tool			Contact extraction tool (metallic)	Contact extraction tool (plastic)
				Automatic tool: M22520/23-01		Manual hand tool: M300 BT		
				Die set	Locator	Locator		
#4	Male	8599-7534	#4-5 or #10-16mm ²	M22520/23-04	M22520/23-11	N/A	8533-8175	M81969/14-07
	Female	8599-7535						
#8 JVS only	Male	8599-7544	#8 or #10	M22520/23-02	8599-9601	SP 593	8660-197	M81969/14-12
	Female	8599-7541						
#8	Male	8599-7580						
	Female	8599-7581						

Automatic tool for contacts #4 & #8



Crimping tool M22520/23-01



Die set



Locator

Manual hand tool for contacts #8



Crimping tool M300 BT



Locator

Extraction tool



Metallic tool

For further information contact us at contactmilaero@souriau.com or visit our web site www.souriau.com