

FEATURES

- 1/+2 LSB DNL
- ±3 LSB INL
- Low noise: 12 nV/√Hz
- Low power: $I_{DD} = 10 \mu\text{A}$
- 0.5 μs settling time
- 4Q multiplying reference input
- 2 mA full-scale current ± 20%, with $V_{REF} = 10 \text{ V}$
- Built-in RFB facilitates voltage conversion
- 3-wire interface
- Ultracompact 8-lead MSOP and 8-lead SOIC packages

ENHANCED PRODUCT FEATURES

- Supports defense and aerospace applications (AQEC)
- Military temperature range (-55°C to +125°C)
- Controlled manufacturing baseline
- One assembly/test site
- One fabrication site
- Enhanced product change notification
- Qualification data available on request

APPLICATIONS

- Automatic test equipment
- Instrumentation
- Digitally controlled calibration
- Industrial control PLCs

GENERAL DESCRIPTION

The [AD5543-EP](#) is a precision 16-bit, low power, current output, small form factor digital-to-analog converter (DAC). It is designed to operate from a single 5 V supply with a ±10 V multiplying reference.

The applied external reference, V_{REF} , determines the full-scale output current. An internal feedback resistor (R_{FB}) facilitates the R-2R and temperature tracking for voltage conversion when combined with an external op amp.

FUNCTIONAL BLOCK DIAGRAM

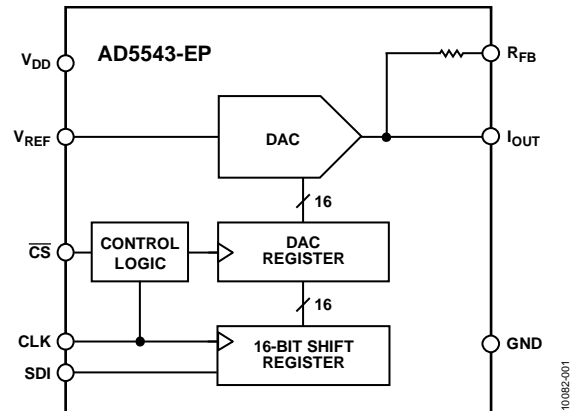

Figure 1.

10082-001

A serial-data interface offers high speed, 3-wire microcontroller-compatible inputs using serial data in (SDI), clock (CLK), and chip select (CS).

The [AD5543-EP](#) is packaged in an ultracompact (3 mm × 4.7 mm) 8-lead MSOP package.

Full details about this enhanced product are available in the [AD5543](#) data sheet, which should be consulted in conjunction with this data sheet.

Rev. 0

Information furnished by Analog Devices is believed to be accurate and reliable. However, no responsibility is assumed by Analog Devices for its use, nor for any infringements of patents or other rights of third parties that may result from its use. Specifications subject to change without notice. No license is granted by implication or otherwise under any patent or patent rights of Analog Devices. Trademarks and registered trademarks are the property of their respective owners.

TABLE OF CONTENTS

Features	1	Timing Diagram	4
Enhanced Product Features	1	Absolute Maximum Ratings	5
Applications.....	1	ESD Caution.....	5
Functional Block Diagram	1	Pin Configuration and Function Descriptions.....	6
General Description	1	Typical Performance Characteristics	7
Revision History	2	Outline Dimensions	9
Specifications.....	3	Ordering Guide	9

REVISION HISTORY

2/12—Revision 0: Initial Version

SPECIFICATIONS

$V_{DD} = 5\text{ V} \pm 10\%$, $V_{SS} = 0\text{ V}$, $I_{OUT} = \text{virtual GND}$, $GND = 0\text{ V}$, $V_{REF} = 10\text{ V}$, $T_A = \text{full operating temperature range}$, unless otherwise noted.

Table 1.

Parameter	Symbol	Condition	5 V \pm 10%	Unit
STATIC PERFORMANCE¹				
Resolution	N	1 LSB = $V_{REF}/2^{16} = 153\ \mu\text{V}$ when $V_{REF} = 10\text{ V}$	16	Bits
Relative Accuracy	INL		± 3	LSB max
Differential Nonlinearity	DNL	Monotonic	-1/+2	LSB max
Output Leakage Current	I_{OUT}	Data = 0x0000, $T_A = 25^\circ\text{C}$	10	nA max
		Data = 0x0000, $T_A = T_A \text{ maximum}$	20	nA max
Full-Scale Gain Error	G_{FSE}	Data = 0xFFFF	$\pm 1/\pm 4$	mV typ/max
Full-Scale Temperature Coefficient ²	TCV_{FS}		1	ppm/ $^\circ\text{C}$ typ
REFERENCE INPUT				
V_{REF} Range	V_{REF}		-15/+15	V min/max
Input Resistance	R_{REF}		5	k Ω typ ³
Input Capacitance ²	C_{REF}		5	pF typ
ANALOG OUTPUT				
Output Current	I_{OUT}	Data = 0xFFFF	2	mA typ
Output Capacitance ²	C_{OUT}	Code dependent	200	pF typ
LOGIC INPUTS AND OUTPUT				
Logic Input Low Voltage	V_{IL}		0.8	V max
Logic Input High Voltage	V_{IH}		2.4	V min
Input Leakage Current	I_{IL}		10	μA max
Input Capacitance ²	C_{IL}		10	pF max
INTERFACE TIMING^{2, 4}				
Clock Input Frequency	f_{CLK}		50	MHz
Clock Width High	t_{CH}		10	ns min
Clock Width Low	t_{CL}		10	ns min
\overline{CS} to Clock Setup	t_{CSS}		0	ns min
Clock to \overline{CS} Hold	t_{CSH}		10	ns min
Data Setup	t_{DS}		5	ns min
Data Hold	t_{DH}		10	ns min
SUPPLY CHARACTERISTICS				
Power Supply Range	$V_{DD \text{ RANGE}}$		4.5/5.5	V min/max
Positive Supply Current	I_{DD}	Logic inputs = 0 V	10	μA max
Power Dissipation	P_{DISS}	Logic inputs = 0 V	0.055	mW max
Power Supply Sensitivity	P_{SS}	$\Delta V_{DD} = \pm 5\%$	0.006	%/% max
AC CHARACTERISTICS⁴				
Output Voltage Settling Time	t_S	To $\pm 0.1\%$ of full scale, Data = 0x0000 to 0xFFFF to 0x0000	0.5	μs typ
Reference Multiplying Bandwidth	BW	$V_{REF} = 100\text{ mV rms}$, data = 0xFFFF	6.6	MHz typ
DAC Glitch Impulse	Q	$V_{REF} = 0\text{ V}$, data = 0x7FFF to 0x8000	7	nV-sec
Feedthrough Error	V_{OUT}/V_{REF}	Data = 0x0000, $V_{REF} = 100\text{ mV rms}$, same channel	-83	dB
Digital Feedthrough	Q	$C_S = 1$ and $f_{CLK} = 1\text{ MHz}$	7	nV-sec
Total Harmonic Distortion	THD	$V_{REF} = 5\text{ V p-p}$, data = 0xFFFF, $f = 1\text{ kHz}$	-103	dB typ
Output Spot Noise Voltage	e_N	$f = 1\text{ kHz}$, BW = 1 Hz	12	nV/ $\sqrt{\text{Hz}}$

¹ All static performance tests (except I_{OUT}) are performed in a closed-loop system using an external precision OP177 I-to-V converter amplifier. The R_{FB} terminal is tied to the amplifier output. The +IN op amp is grounded, and the DAC I_{OUT} is tied to the -IN op amp. Typical values represent average readings measured at 25°C .

² These parameters are guaranteed by design and are not subject to production testing.

³ All ac characteristic tests are performed in a closed-loop system using an AD8038 I-to-V converter amplifier except for THD where an AD8065 was used.

⁴ All input control signals are specified with $t_R = t_F = 2.5\text{ ns}$ (10% to 90% of 3 V) and timed from a voltage level of 1.5 V.

TIMING DIAGRAM

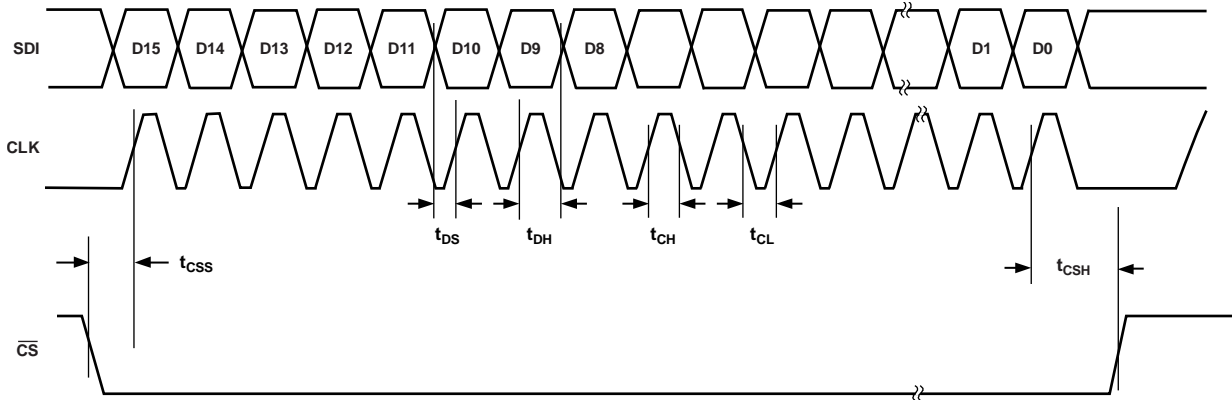

Figure 2. Timing Diagram

10082-016

ABSOLUTE MAXIMUM RATINGS

Table 2.

Parameter	Rating
V_{DD} to GND	-0.3 V to +8 V
V_{REF} to GND	-18 V to +18 V
Logic Inputs to GND	-0.3 V to +8 V
$V(I_{OUT})$ to GND	-0.3 V to $V_{DD} + 0.3$ V
Input Current to Any Pin Except Supplies	± 50 mA
Package Power Dissipation	$(T_{J_{Max}} - T_A)/\theta_{JA}$
Thermal Resistance, θ_{JA}	
8-Lead Surface Mount (MSOP)	150°C/W
Maximum Junction Temperature ($T_{J_{Max}}$)	150°C
Operating Temperature Range	
Enhanced Plastic (EP Version)	-55°C to +125°C
Storage Temperature Range	-65°C to +150°C
Lead Temperature	
RM-8 (Vapor Phase, 60 sec)	215°C
RM-8 (Infrared, 15 sec)	220°C

Stresses above those listed under Absolute Maximum Ratings may cause permanent damage to the device. This is a stress rating only; functional operation of the device at these or any other conditions above those indicated in the operational section of this specification is not implied. Exposure to absolute maximum rating conditions for extended periods may affect device reliability.

ESD CAUTION



ESD (electrostatic discharge) sensitive device. Charged devices and circuit boards can discharge without detection. Although this product features patented or proprietary protection circuitry, damage may occur on devices subjected to high energy ESD. Therefore, proper ESD precautions should be taken to avoid performance degradation or loss of functionality.

PIN CONFIGURATION AND FUNCTION DESCRIPTIONS

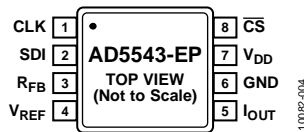

Figure 3. Pin Configuration

Table 3. Pin Function Descriptions

Pin No.	Mnemonic	Description
1	CLK	Clock Input. Positive-edge triggered, clocks data into shift register.
2	SDI	Serial Register Input. Data loads directly into the shift register MSB first. Extra leading bits are ignored.
3	R _{FB}	Internal Matching Feedback Resistor. This pin connects to an external op amp for voltage output.
4	V _{REF}	DAC Reference Input Pin. Establishes DAC full-scale voltage. Constant input resistance vs. code.
5	I _{OUT}	DAC Current Output. This pin connects to the inverting terminal of the external precision I-to-V op amp for voltage output.
6	GND	Analog and Digital Ground.
7	V _{DD}	Positive Power Supply Input. Specified range of operation at 5 V ± 10%.
8	\overline{CS}	Chip Select. Active low digital input. Transfers shift-register data to DAC register on rising edge.

TYPICAL PERFORMANCE CHARACTERISTICS

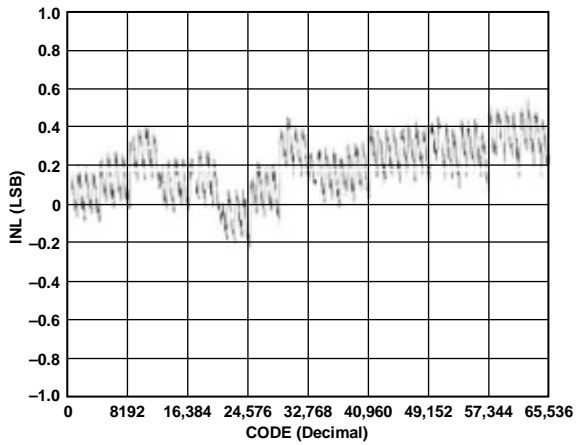

Figure 4. Integral Nonlinearity Error

10082-005

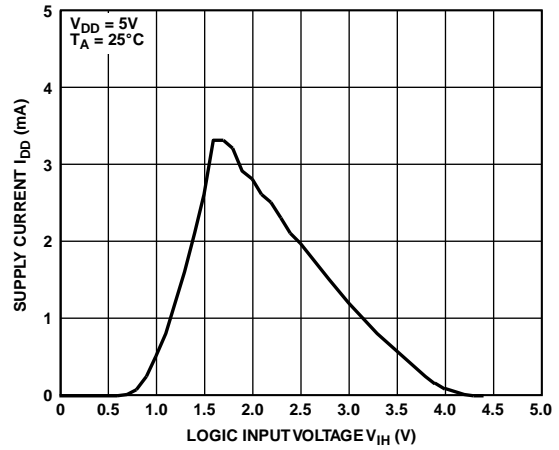

Figure 7. Supply Current, I_{DD} vs. Logic Input Voltage, V_{IH}

10082-010

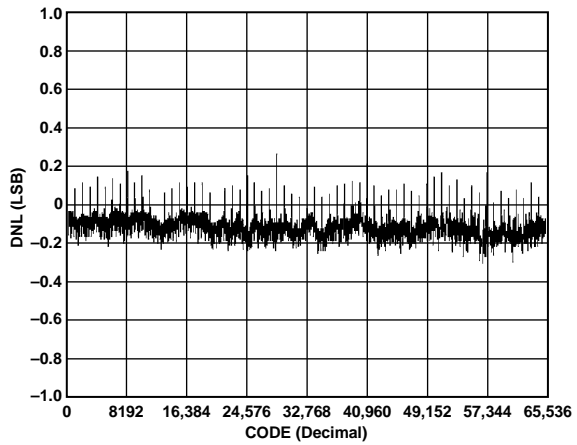

Figure 5. Differential Nonlinearity Error

10082-006

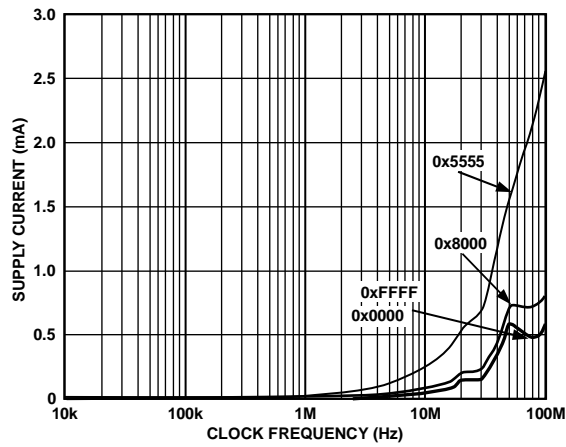

Figure 8. Supply Current vs. Clock Frequency

10082-011

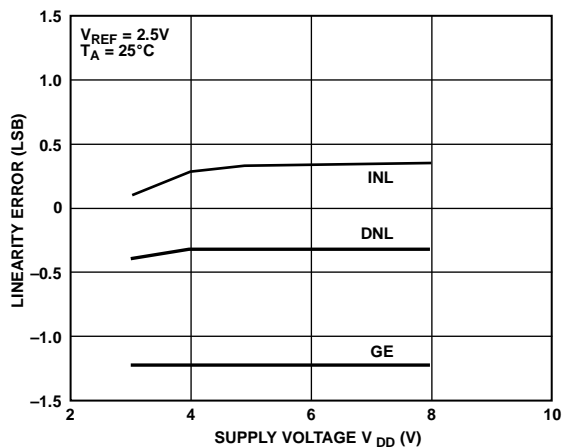

Figure 6. Linearity Error vs. Supply Voltage, V_{DD}

10082-009

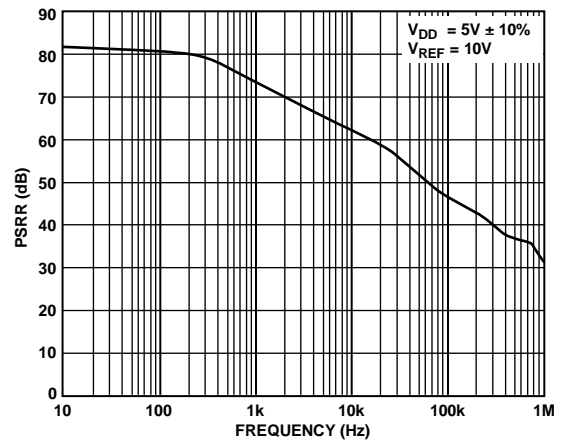

Figure 9. Power Supply Rejection Ratio (PSRR) vs. Frequency

10082-012

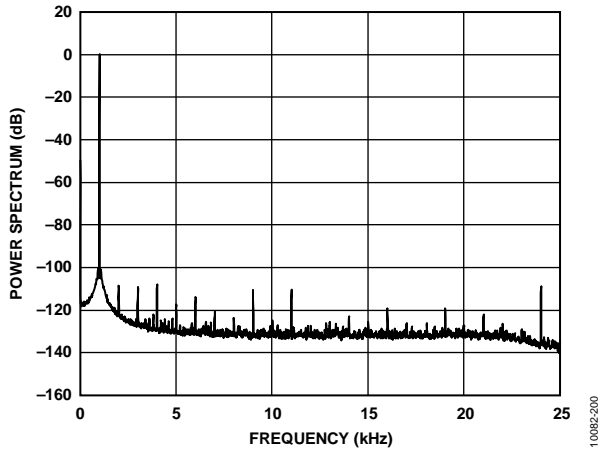

Figure 10. Analog Total Harmonic Distortion

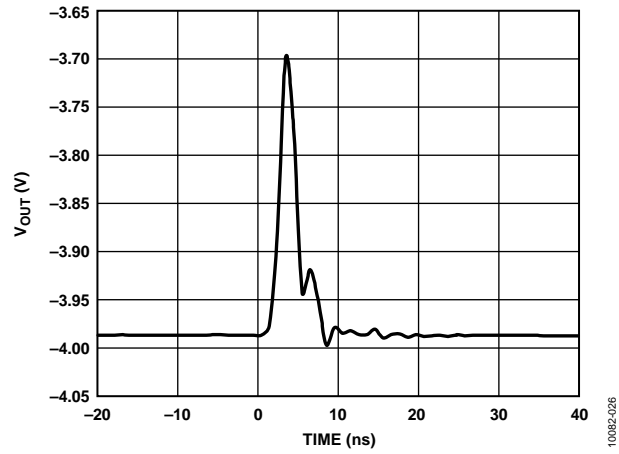

Figure 12. Midscale Transition and Digital Feedthrough

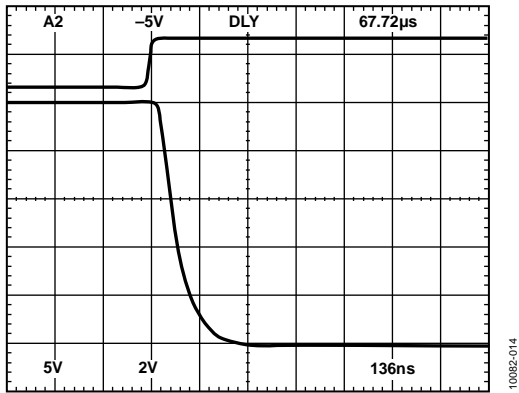
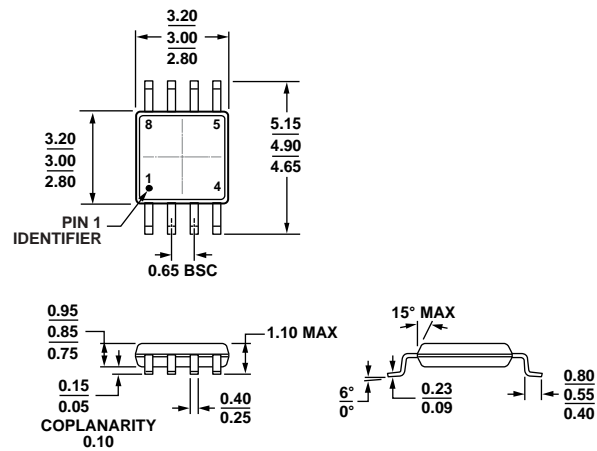

Figure 11. Settling Time

OUTLINE DIMENSIONS



COMPLIANT TO JEDEC STANDARDS MO-187-AA

Figure 13. 8-Lead Mini Small Outline Package [MSOP] (RM-8)

Dimensions shown in millimeters

10-07-2009-B

ORDERING GUIDE

Model ^{1, 2}	INL (LSB)	RES (LSB)	Temperature Range	Package Description	Package Option	Branding
AD5543SRMZ-EP	±3	16	-55°C to +125°C	8-Lead Mini Small Outline Package [MSOP]	RM-8	DHR

¹ The AD5543 contains 1040 transistors. The die size measures 55 mil × 73 mil or 4,015 sq. mil.

² Z = RoHS Compliant Part.

NOTES

NOTES

NOTES