

## GaAs MMIC BI-PHASE MODULATOR, 1.8 - 5.2 GHz

### Typical Applications

The HMC135 is suitable for:

- Wireless Local Loop
- LMDS & VSAT
- Point-to-Point Radios
- Test Equipment

### Features

- Chip Integrates Directly into MIC Designs
- Carrier Suppression: 30 dB
- Direct Modulation in the 1.8 - 5.2 GHz Band
- Functions also as a Phase Detector
- Die Size: 1.45 x 1.45 x 0.1 mm

### Functional Diagram

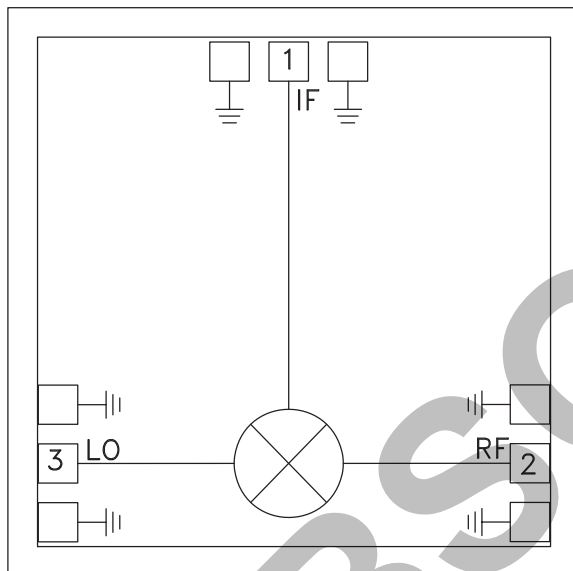

### General Description

The HMC135 Bi-Phase Modulator is designed to phase-modulate an RF signal into reference and 180 degree states. Device input is at the RF port and output is at the LO port. The polarity of the bias current at the control port (IF port) defines the phase states. Excellent amplitude and phase balance provided by closely matched monolithic balun and diode circuits delivers 30 dB of carrier suppression in a tiny monolithic chip.

The device also functions as a demodulator or phase comparator. As a demodulator, data emerges at the control port when a modulated signal at the RF port is compared to a reference signal at the LO port. As a phase comparator, the phase angle between two signals applied to the RF and LO ports is represented by an analog voltage at the control port. Except for carrier suppression, the data presented here was measured under static conditions in which a DC bias current (nominally 5 mA) is applied to the control port.

### Electrical Specifications, $T_A = +25^\circ \text{C}$ , 5 mA Bias Current

Parameter	Min.	Typ.	Max.	Units
Frequency Band		1.8 - 5.2		GHz
Insertion Loss		9	11	dB
Return Loss, RF and LO Ports	2.5	3.0		dB
Amplitude Balance		0.2	0.5	dB
Phase Balance		2.5	5.0	Deg
Carrier Suppression (When driven with a 1 MHz square wave, 1.4 Vp-p)	25	30		dBc
Input Power for 1 dB Compression	0	8		dBm
Third Order Intercept, Input	5	10		dBm
Second Order Intercept, Input	15	30		dBm
Bias Current (Bias current forward biases internal Schottky diodes providing approximately 0.6 V at the control port).	2	5	10	mA

Information furnished by Analog Devices is believed to be accurate and reliable. However, no responsibility is assumed by Analog Devices for its use, nor for any infringements of patents or other rights of third parties that may result from its use. Specifications subject to change without notice. No license is granted by implication or otherwise under any patent or patent rights of Analog Devices. Trademarks and registered trademarks are the property of their respective owners.

For price, delivery, and to place orders: Analog Devices, Inc., One Technology Way, P.O. Box 9106, Norwood, MA 02062-9106 Phone: 781-329-4700 • Order online at [www.analog.com](http://www.analog.com) Application Support: Phone: 1-800-ANALOG-D

**GaAs MMIC BI-PHASE  
MODULATOR, 1.8 - 5.2 GHz**

**Insertion Loss**

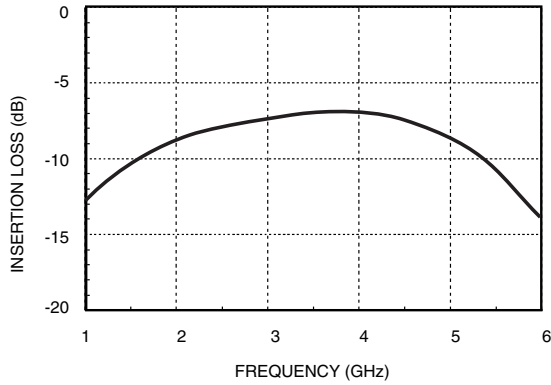

**Amplitude Balance**

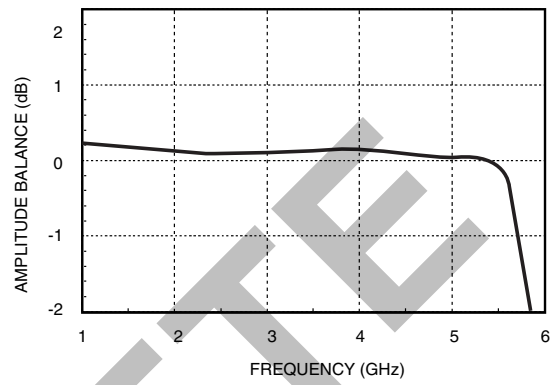

**Phase Balance**

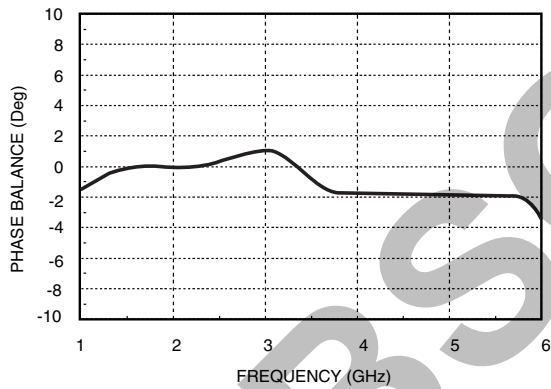

**Carrier Suppression \***

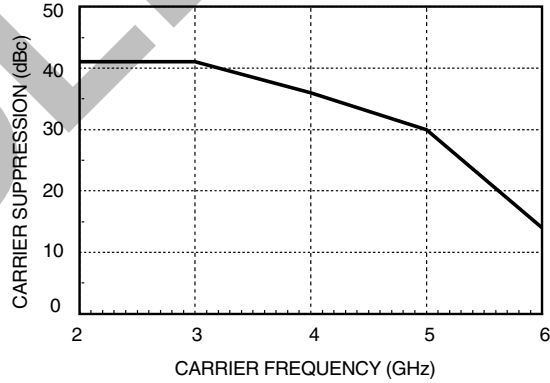

**Return Loss**

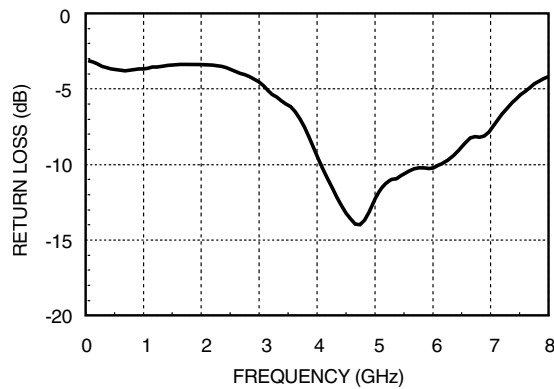

\* (For 1.4 Vp-p Square Wave Modulation at 1 MHz)

Information furnished by Analog Devices is believed to be accurate and reliable. However, no responsibility is assumed by Analog Devices for its use, nor for any infringements of patents or other rights of third parties that may result from its use. Specifications subject to change without notice. No license is granted by implication or otherwise under any patent or patent rights of Analog Devices. Trademarks and registered trademarks are the property of their respective owners.

For price, delivery, and to place orders: Analog Devices, Inc., One Technology Way, P.O. Box 9106, Norwood, MA 02062-9106 Phone: 781-329-4700 • Order online at [www.analog.com](http://www.analog.com) Application Support: Phone: 1-800-ANALOG-D

**GaAs MMIC BI-PHASE MODULATOR, 1.8 - 5.2 GHz**

**Input Compression vs Frequency \***

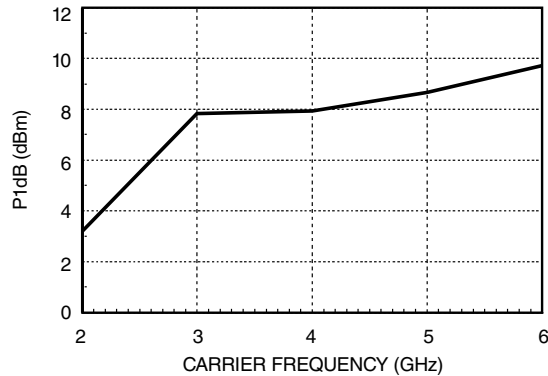

**Input Compression vs Bias at 4 GHz**

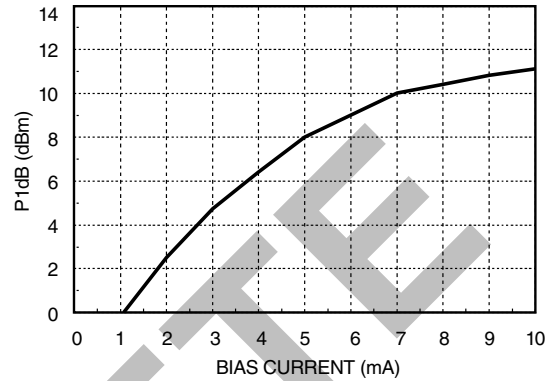

**Input Third Order Intercept vs Frequency \***

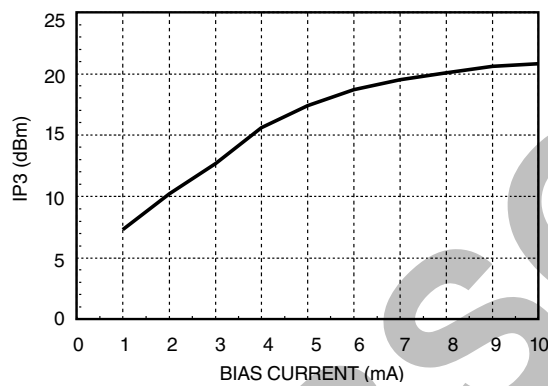

**Input Third Order Intercept vs Bias at 4 GHz**

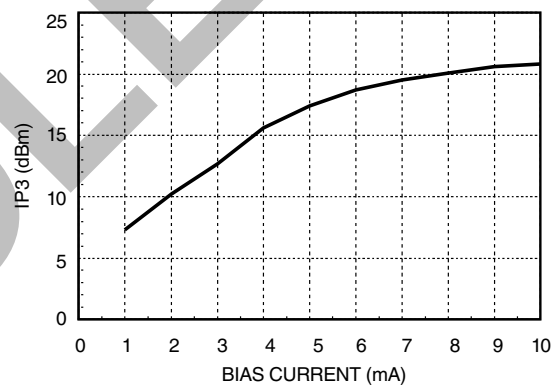

\* (For 5 mA Bias Current)

**Suggested TTL Driver for a Bi-Phase Modulator**

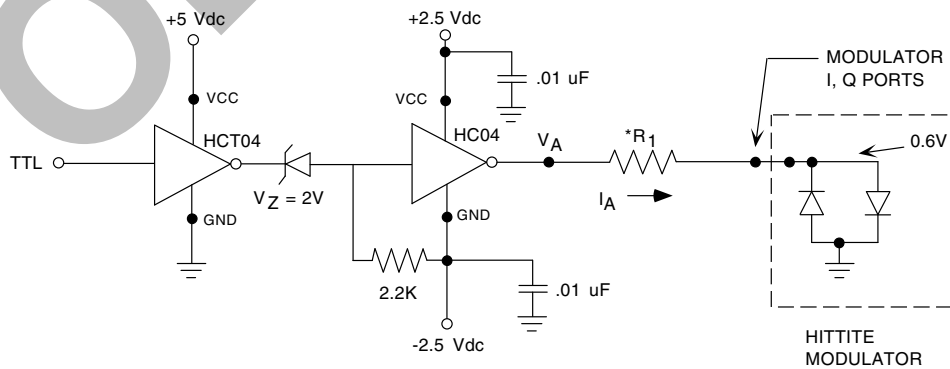

**Notes**

1.  $V_A$  Alternates Between  $\pm 2.4 V_{dc}$   
 $\pm I_A = 2.4 - 0.6 = \pm 5 \text{ mA}$   
 360 Ohm

2. HCT04 and HC04 are QMOS HEX Inverters.  
 $*R_1 = 300 \text{ to } 620 \pm 2\%$  Select  $R_1$  To Supply  $\pm 3 \text{ to } \pm 6 \text{ mA}$  to the IF Port.

Information furnished by Analog Devices is believed to be accurate and reliable. However, no responsibility is assumed by Analog Devices for its use, nor for any infringements of patents or other rights of third parties that may result from its use. Specifications subject to change without notice. No license is granted by implication or otherwise under any patent or patent rights of Analog Devices. Trademarks and registered trademarks are the property of their respective owners.

For price, delivery, and to place orders: Analog Devices, Inc., One Technology Way, P.O. Box 9106, Norwood, MA 02062-9106 Phone: 781-329-4700 • Order online at [www.analog.com](http://www.analog.com) Application Support: Phone: 1-800-ANALOG-D

**GaAs MMIC BI-PHASE MODULATOR, 1.8 - 5.2 GHz**

**Outline Drawing**

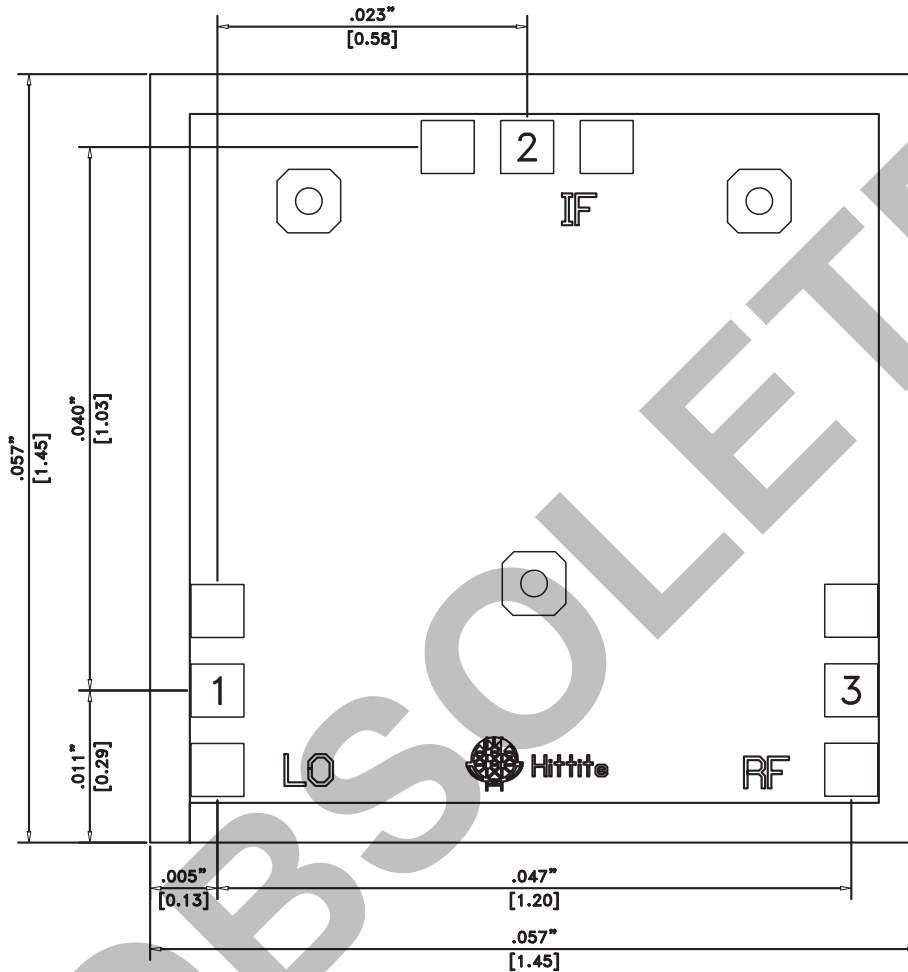

**Die Packaging Information** [1]

Standard	Alternate
WP-3 (Waffle Pack)	[2]

[1] Refer to the "Packaging Information" section for die packaging dimensions.

[2] For alternate packaging information contact Hittite Microwave Corporation.

NOTES:

1. ALL DIMENSIONS ARE IN INCHES [MM].
2. TYPICAL BOND PAD IS .004" SQUARE.
3. BOND PAD SPACING IS .006" CENTER TO CENTER.
4. BACKSIDE METALIZATION: GOLD.
5. BACKSIDE METAL IS GROUND.
6. BOND PAD METALIZATION: GOLD.
7. CONNECTION NOT REQUIRED FOR UNLABELED BOND PADS.



**ELECTROSTATIC SENSITIVE DEVICE  
OBSERVE HANDLING PRECAUTIONS**

## GaAs MMIC BI-PHASE MODULATOR, 1.8 - 5.2 GHz

### Pad Descriptions

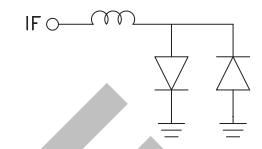
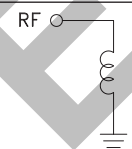
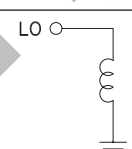
Pad Number	Function	Description	Interface Schematic
1	IF	This pin is DC coupled. For applications not requiring operation to DC, this port should be DC blocked externally using a series capacitor whose value has been chosen to pass the necessary IF frequency range. For operation to DC this pin must not source or sink more than 10mA of current or die non-function and possible die failure will result.	
2	RF	DC coupled and matched to 50 Ohms.	
3	LO	DC coupled and matched to 50 Ohms.	

OBSOLETE

## GaAs MMIC BI-PHASE MODULATOR, 1.8 - 5.2 GHz

### Mounting & Bonding Techniques for Millimeterwave GaAs MMICs

The die should be attached directly to the ground plane eutectically or with conductive epoxy (see HMC general Handling, Mounting, Bonding Note).

50 Ohm Microstrip transmission lines on 0.127mm (5 mil) thick alumina thin film substrates are recommended for bringing RF to and from the chip (Figure 1). If 0.254mm (10 mil) thick alumina thin film substrates must be used, the die should be raised 0.150mm (6 mils) so that the surface of the die is coplanar with the surface of the substrate. One way to accomplish this is to attach the 0.102mm (4 mil) thick die to a 0.150mm (6 mil) thick molybdenum heat spreader (moly-tab) which is then attached to the ground plane (Figure 2).

Microstrip substrates should be placed as close to the die as possible in order to minimize bond wire length. Typical die-to-substrate spacing is 0.076mm to 0.152 mm (3 to 6 mils).

#### Handling Precautions

Follow these precautions to avoid permanent damage.

**Storage:** All bare die are placed in either Waffle or Gel based ESD protective containers, and then sealed in an ESD protective bag for shipment. Once the sealed ESD protective bag has been opened, all die should be stored in a dry nitrogen environment.

**Cleanliness:** Handle the chips in a clean environment. DO NOT attempt to clean the chip using liquid cleaning systems.

**Static Sensitivity:** Follow ESD precautions to protect against ESD strikes.

**Transients:** Suppress instrument and bias supply transients while bias is applied. Use shielded signal and bias cables to minimize inductive pick-up.

**General Handling:** Handle the chip along the edges with a vacuum collet or with a sharp pair of bent tweezers. The surface of the chip has fragile air bridges and should not be touched with vacuum collet, tweezers, or fingers.

#### Mounting

The chip is back-metallized and can be die mounted with AuSn eutectic preforms or with electrically conductive epoxy. The mounting surface should be clean and flat.

**Eutectic Die Attach:** A 80/20 gold tin preform is recommended with a work surface temperature of 255 deg. C and a tool temperature of 265 deg. C. When hot 90/10 nitrogen/hydrogen gas is applied, tool tip temperature should be 290 deg. C. DO NOT expose the chip to a temperature greater than 320 deg. C for more than 20 seconds. No more than 3 seconds of scrubbing should be required for attachment.

**Epoxy Die Attach:** Apply a minimum amount of epoxy to the mounting surface so that a thin epoxy fillet is observed around the perimeter of the chip once it is placed into position. Cure epoxy per the manufacturer's schedule.

#### Wire Bonding

RF bonds made with 0.003" x 0.0005" ribbon are recommended. These bonds should be thermosonically bonded with a force of 40-60 grams. DC bonds of 0.001" (0.025 mm) diameter, thermosonically bonded, are recommended. Ball bonds should be made with a force of 40-50 grams and wedge bonds at 18-22 grams. All bonds should be made with a nominal stage temperature of 150 °C. A minimum amount of ultrasonic energy should be applied to achieve reliable bonds. All bonds should be as short as possible, less than 12 mils (0.31 mm).

