

## FEATURES

- Conversion loss: 8 dB**
- LO to RF isolation: 50 dB**
- LO to IF isolation: 35 dB**
- Input third-order intercept (IP3): 18 dBm**
- Input second-order intercept (IP2): 55 dBm**
- LO port return loss: 8 dBm**
- RF port return loss: 10 dBm**
- Passive double balanced topology**
- Wide IF bandwidth: dc to 3 GHz**
- 24-terminal ceramic leadless chip carrier package**

## APPLICATIONS

- WiMAX and fixed wireless**
- Point to point radios**
- Point to multipoint radios**
- Test equipment and sensors**
- Military end use**

## GENERAL DESCRIPTION

The [HMC557A](#) is a general-purpose, double balanced mixer in a 24-terminal, ceramic leadless chip carrier, RoHS-compliant package. The device can be used as an upconverter or down-converter from 2.5 GHz to 7.0 GHz. This mixer is fabricated in a gallium arsenide (GaAs) metal semiconductor field effect transistor (MESFET) process and requires no external components or matching circuitry.

## FUNCTIONAL BLOCK DIAGRAM

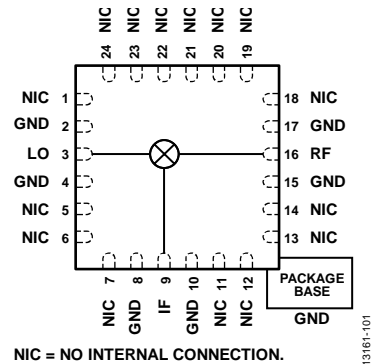

Figure 1.

The [HMC557A](#) provides excellent local oscillator (LO) to radio frequency (RF) and LO to intermediate frequency (IF) isolation due to optimized balun structures. The RoHS-compliant [HMC557A](#) eliminates the need for wire bonding and is compatible with high volume surface-mount manufacturing techniques.

## TABLE OF CONTENTS

Features .....	1	Downconverter Performance with Lower Sideband Selected, IF = 2000 MHz.....	13
Applications.....	1	P1dB Performance with Downconverter Mode Selected at LO Drive = 15 dBm .....	14
Functional Block Diagram .....	1	Upconverter Performance with Upper Sideband Selected, IF = 100 MHz.....	15
General Description .....	1	Upconverter Performance with Upper Sideband Selected, IF = 1000 MHz.....	16
Revision History .....	2	Upconverter Performance with Upper Sideband Selected, IF = 2000 MHz.....	17
Electrical Specifications .....	3	Upconverter Performance with Lower Sideband Selected, IF = 100 MHz.....	18
2.5 GHz to 5.0 GHz Frequency Range.....	3	Upconverter Performance with Lower Sideband Selected, IF = 1000 MHz.....	19
5.0 GHz to 7.0 GHz Frequency Range.....	3	Upconverter Performance with Lower Sideband Selected, IF = 2000 MHz.....	20
Absolute Maximum Ratings.....	4	Spurious Performance with Upper Sideband Selected, IF = 100 MHz.....	21
ESD Caution.....	4	Applications Information .....	22
Pin Configuration and Function Descriptions.....	5	Outline Dimensions .....	23
Interface Schematics.....	6	Ordering Guide .....	23
Typical Performance Characteristics .....	7		
Downconverter Performance with Upper Sideband Selected, IF = 100 MHz.....	7		
Downconverter Performance with Upper Sideband Selected, IF = 1000 MHz.....	9		
Downconverter Performance with Upper Sideband Selected, IF = 2000 MHz.....	10		
Downconverter Performance with Lower Sideband Selected, IF = 100 MHz.....	11		
Downconverter Performance with Lower Sideband Selected, IF = 1000 MHz.....	12		

## REVISION HISTORY

### 10/2017—Rev. D to Rev. E

Added Field Induced Charge Device Model (FICDM) Parameter, Table 3 .....	4
Changes to Ordering Guide.....	23

### 6/2017—Rev. C to Rev. D

Changes to Ordering Guide .....	23
---------------------------------	----

### 8/2016—Rev. B to Rev. C

Changes to Ordering Guide .....	23
---------------------------------	----

### 1/2016—Rev. A to Rev. B

Change to LO to RF Isolation Parameter, Table 2.....	3
--	---

### 9/2015—Rev. 0 to Rev. A

Changes to Features Section .....	1
Added Maximum Peak Reflow Temperature Parameter, Table 3 .....	4
Updated Outline Dimensions.....	23
Changes to Ordering Guide .....	23

### 7/2015—Revision 0: Initial Version

## ELECTRICAL SPECIFICATIONS

### 2.5 GHz TO 5.0 GHz FREQUENCY RANGE

$T_A = 25^\circ\text{C}$ , IF = 100 MHz, LO drive = 15 dBm. All measurements performed as a downconverter with the upper sideband selected, unless otherwise noted.

Table 1.

Parameter	Min	Typ	Max	Unit
OPERATING CONDITIONS				
RF Frequency Range	2.5		5.0	GHz
LO Frequency Range	2.5		5.0	GHz
IF Frequency Range	DC		3	GHz
PERFORMANCE				
Conversion Loss		8	10.5	dB
Noise Figure, Single Sideband (SSB)		8		dB
LO to RF Isolation	40	50		dB
LO to IF Isolation	26	35		dB
RF to IF Isolation		20		dB
Input Third-Order Intercept (IP3)	14	18		dBm
Input Second-Order Intercept (IP2)		55		dBm
Input Power for 1 dB Compression (P1dB)		10		dBm
RF Port Return Loss		10		dB
LO Port Return Loss		8		dB

### 5.0 GHz TO 7.0 GHz FREQUENCY RANGE

$T_A = 25^\circ\text{C}$ , IF = 100 MHz, LO drive = 15 dBm. All measurements performed as a downconverter with the upper sideband selected, unless otherwise noted.

Table 2.

Parameter	Min	Typ	Max	Unit
OPERATING CONDITIONS				
RF Frequency Range	5.0		7.0	GHz
LO Frequency Range	5.0		7.0	GHz
IF Frequency Range	DC		3	GHz
PERFORMANCE				
Conversion Loss		8.5	10.5	dB
Noise Figure, Single Sideband (SSB)		8.5		dB
LO to RF Isolation	37	43		dB
LO to IF Isolation	25	33		dB
RF to IF Isolation		25		dB
Input Third-Order Intercept (IP3)	14	18		dBm
Input Second-Order Intercept (IP2)		55		dBm
Input Power for 1 dB Compression (P1dB)		10		dBm
RF Port Return Loss		12		dB
LO Port Return Loss		12		dB

## ABSOLUTE MAXIMUM RATINGS

Table 3.

Parameter	Rating
RF Input Power	25 dBm
LO Input Power	27 dBm
Channel Temperature	175°C
Continuous $P_{DISS}$ (T = 85°C), Derate 10.81 mW/°C Above 85°C)	972 mW
Thermal Resistance (Channel to Ground Pad)	92.5°C/W
Maximum Peak Reflow Temperature	260°C
Storage Temperature Range	-65°C to +150°C
Operating Temperature Range	-40°C to +85°C
ESD Sensitivity, Human Body Model (HBM)	1000 V (Class 1C)
Field Induced Charge Device Model (FICDM)	1250 V (Class C3)

Stresses at or above those listed under Absolute Maximum Ratings may cause permanent damage to the product. This is a stress rating only; functional operation of the product at these or any other conditions above those indicated in the operational section of this specification is not implied. Operation beyond the maximum operating conditions for extended periods may affect product reliability.

### ESD CAUTION



**ESD (electrostatic discharge) sensitive device.** Charged devices and circuit boards can discharge without detection. Although this product features patented or proprietary protection circuitry, damage may occur on devices subjected to high energy ESD. Therefore, proper ESD precautions should be taken to avoid performance degradation or loss of functionality.

### PIN CONFIGURATION AND FUNCTION DESCRIPTIONS

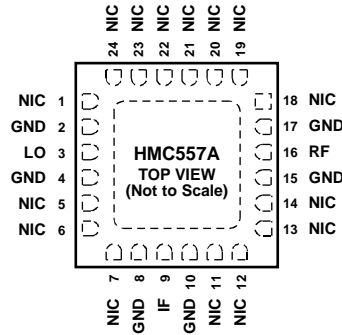

- NOTES**  
 1. NIC = NO INTERNAL CONNECTION.  
 2. CONNECT THE EXPOSED PAD TO A LOW IMPEDANCE THERMAL AND ELECTRICAL GROUND PLANE.

13161-102

Figure 2. Pin Configuration

Table 4. Pin Function Descriptions

Pin No.	Mnemonic	Description
1, 5 to 7, 11 to 14, 18 to 24	NIC	No Internal Connection. No connection is required on these pins. These pins are not internally connected. However, all data is measured with these pins connected to RF/dc ground externally.
2, 4, 8, 10, 15, 17	GND	Ground Connect. Connect these pins and the package bottom to RF/dc ground.
3	LO	Local Oscillator Port. This pin is dc-coupled and matched to 50 Ω.
9	IF	Intermediate Frequency Port. This pin is dc-coupled. For applications not requiring operation to dc, block this pin externally using a series capacitor with a value chosen to pass the necessary IF frequency range. For operation to dc, this pin must not source or sink more than 2 mA of current or device nonfunctionality or device failure may result.
16	RF	Radio Frequency Port. This pin is dc-coupled and matched to 50 Ω.
	EPAD	Exposed Pad. Connect the exposed pad to a low impedance thermal and electrical ground plane.

INTERFACE SCHEMATICS



Figure 3. GND Interface Schematic

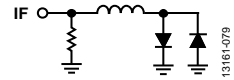

Figure 5. IF Interface Schematic

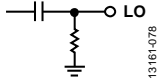

Figure 4. LO Interface Schematic

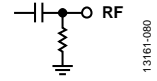

Figure 6. RF Interface Schematic

# TYPICAL PERFORMANCE CHARACTERISTICS

## DOWNCONVERTER PERFORMANCE WITH UPPER SIDEBAND SELECTED, IF = 100 MHz

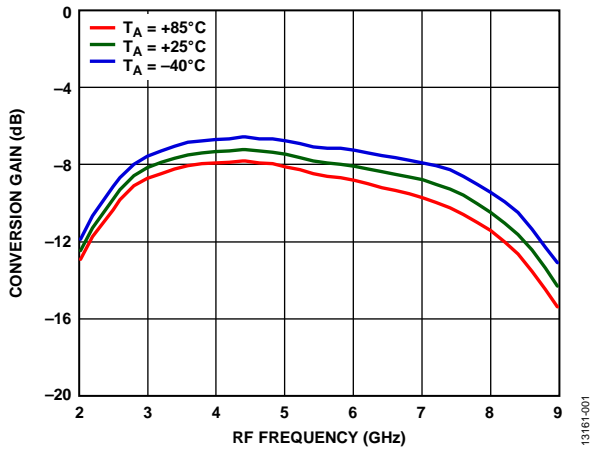

Figure 7. Conversion Gain vs. RF Frequency at Various Temperatures, LO Drive = 15 dBm

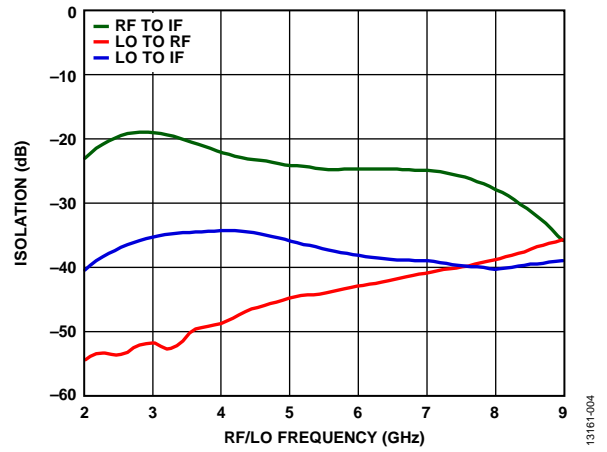

Figure 10. Isolation vs. RF/LO Frequency

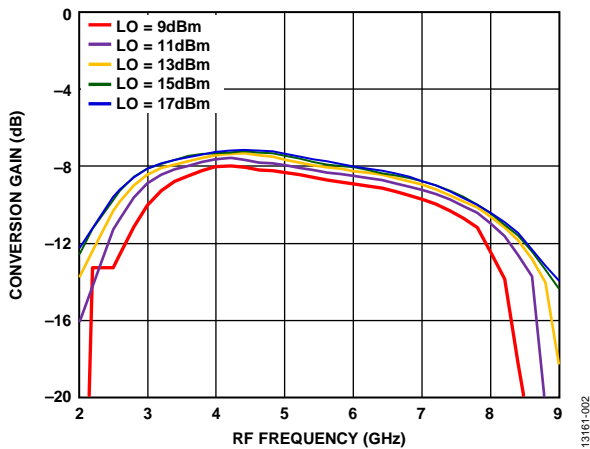

Figure 8. Conversion Gain vs. RF Frequency at Various LO Drives

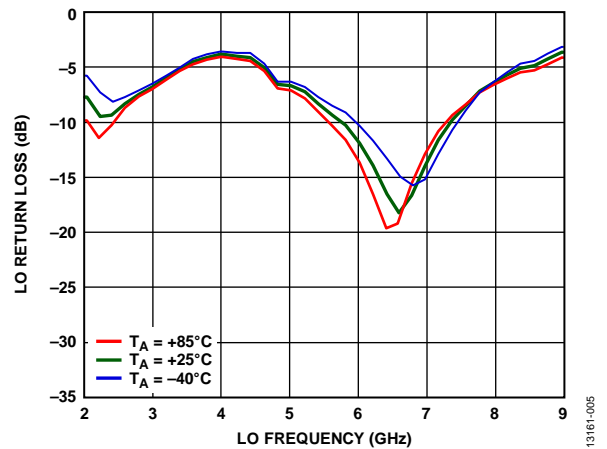

Figure 11. LO Port Return Loss vs. LO Frequency, LO Drive = 15 dBm

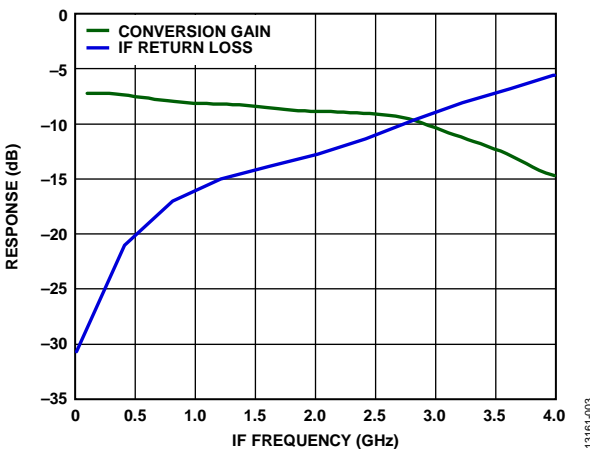

Figure 9. Conversion Gain and IF Return Loss Response vs. IF Frequency, LO Frequency = 4.5 GHz

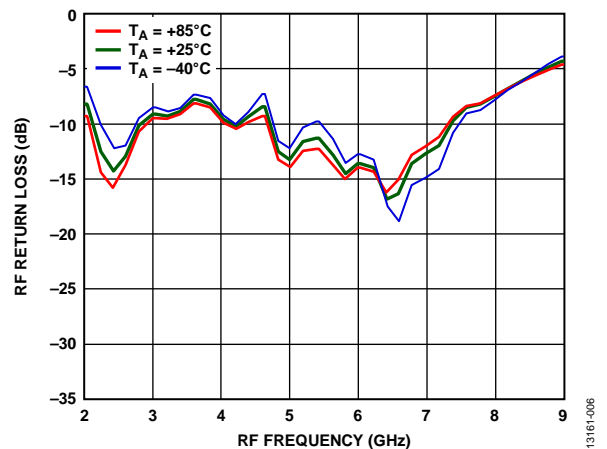

Figure 12. RF Port Return Loss vs. RF Frequency, LO Frequency = 4.6 GHz, LO Drive = 15 dBm

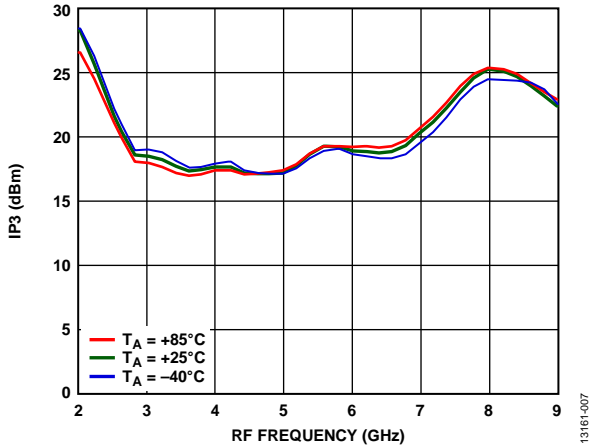

Figure 13. Input IP3 vs. RF Frequency at Various Temperatures, LO Drive = 15 dBm

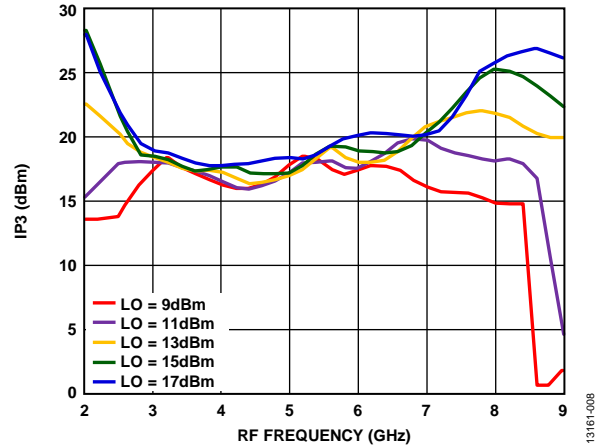

Figure 15. Input IP3 vs. RF Frequency at Various LO Drives

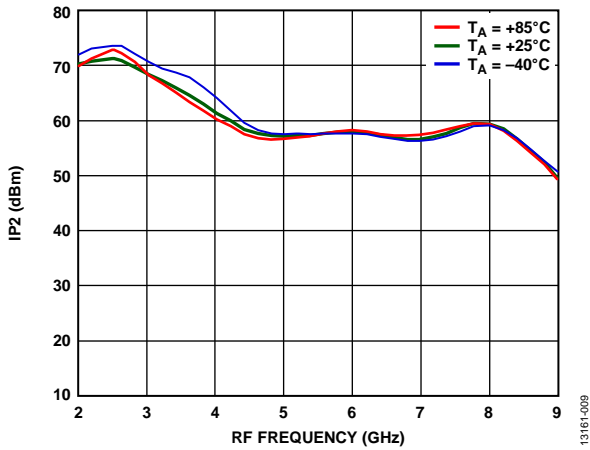

Figure 14. Input IP2 vs. RF Frequency at Various Temperatures, LO Drive = 15 dBm

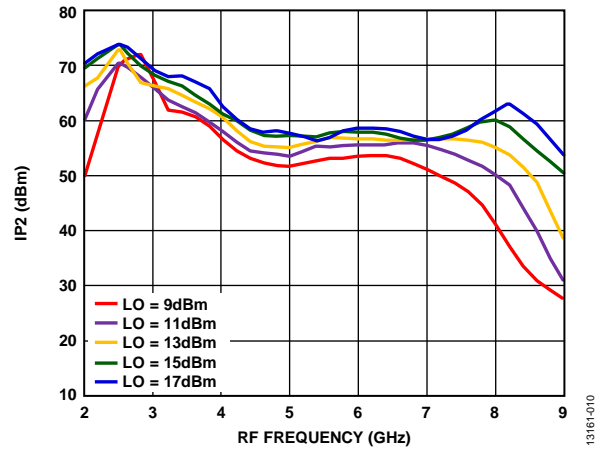

Figure 16. Input IP2 vs. RF Frequency at Various LO Drives



DOWNCONVERTER PERFORMANCE WITH UPPER SIDEBAND SELECTED, IF = 1000 MHz

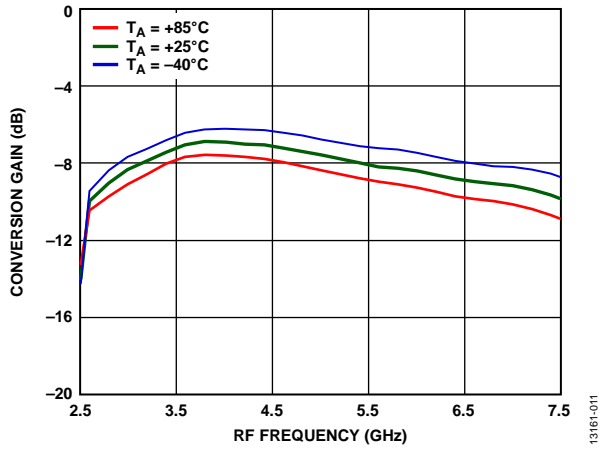

Figure 17. Conversion Gain vs. RF Frequency at Various Temperatures, LO Drive = 15 dBm

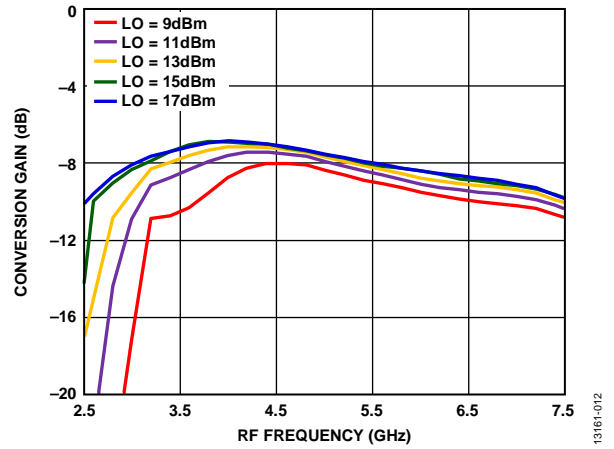

Figure 20. Conversion Gain vs. RF Frequency at Various LO Drives

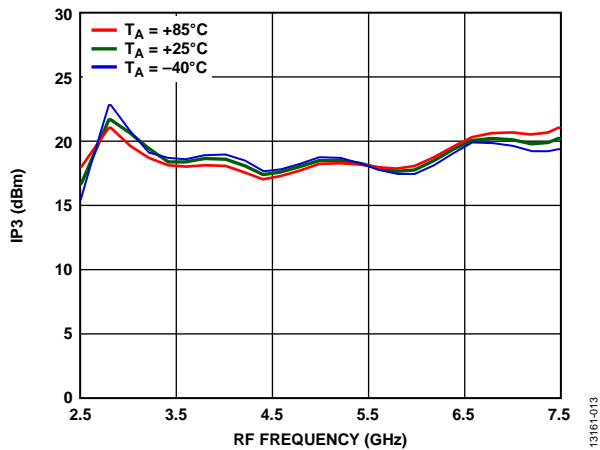

Figure 18. Input IP3 vs. RF Frequency at Various Temperatures, LO Drive = 15 dBm

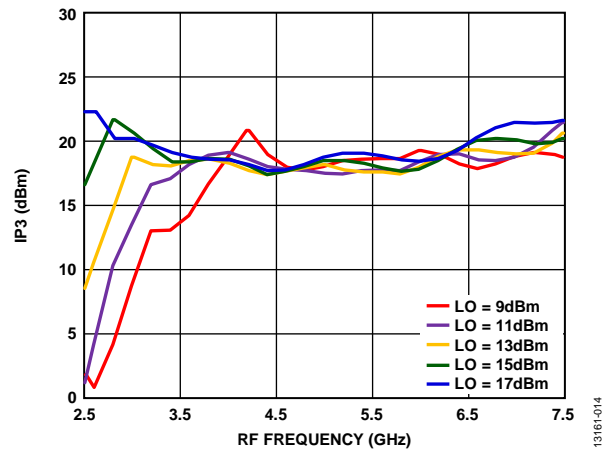

Figure 21. Input IP3 vs. RF Frequency at Various LO Drives

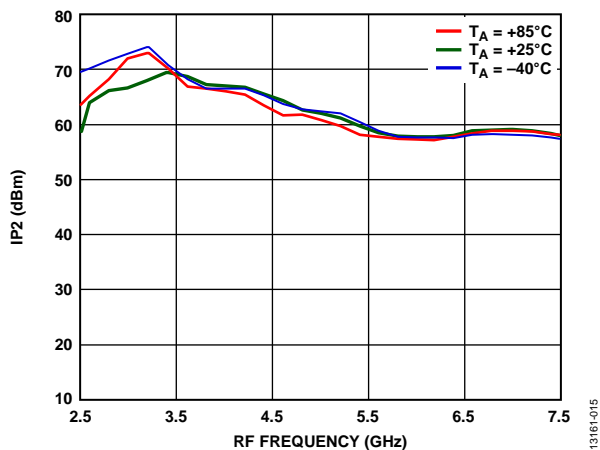

Figure 19. Input IP2 vs. RF Frequency at Various Temperatures, LO Drive = 15 dBm

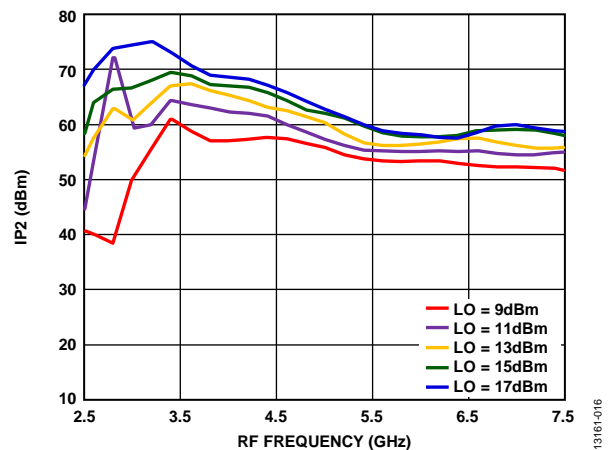

Figure 22. Input IP2 vs. RF Frequency at Various LO Drives

DOWNCONVERTER PERFORMANCE WITH UPPER SIDEBAND SELECTED, IF = 2000 MHz

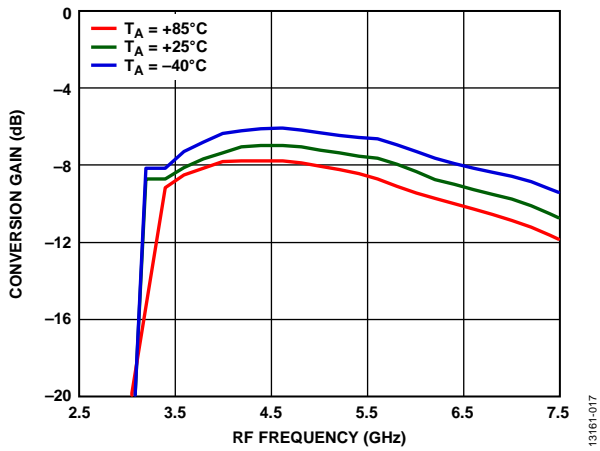

Figure 23. Conversion Gain vs. RF Frequency at Various Temperatures, LO Drive = 15 dBm

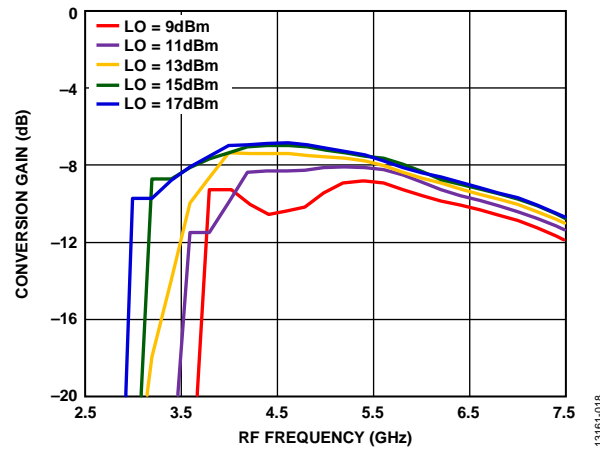

Figure 26. Conversion Gain vs. RF Frequency at Various LO Drives

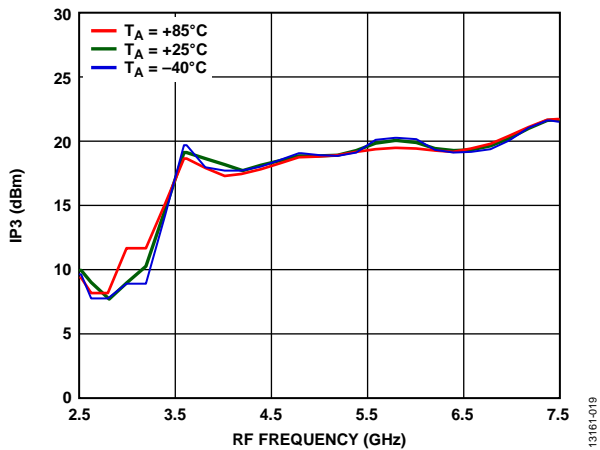

Figure 24. Input IP3 vs. RF Frequency at Various Temperatures, LO Drive = 15 dBm

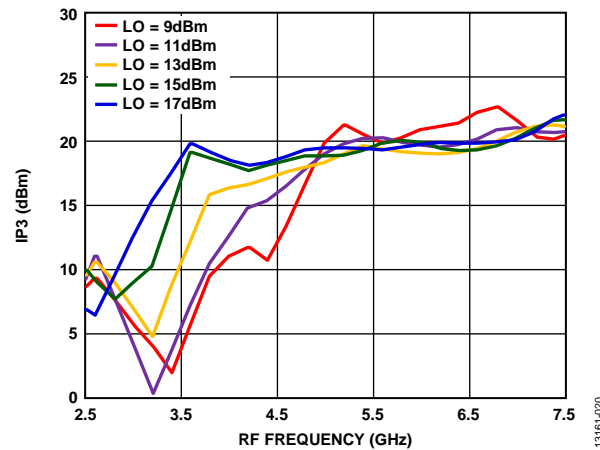

Figure 27. Input IP3 vs. RF Frequency at Various LO Drives

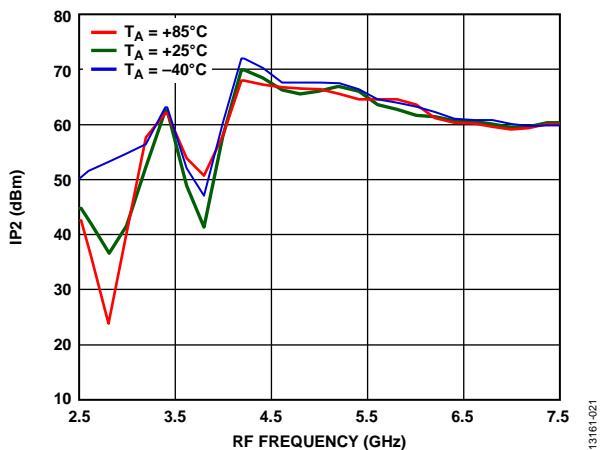

Figure 25. Input IP2 vs. RF Frequency at Various Temperatures, LO Drive = 15 dBm

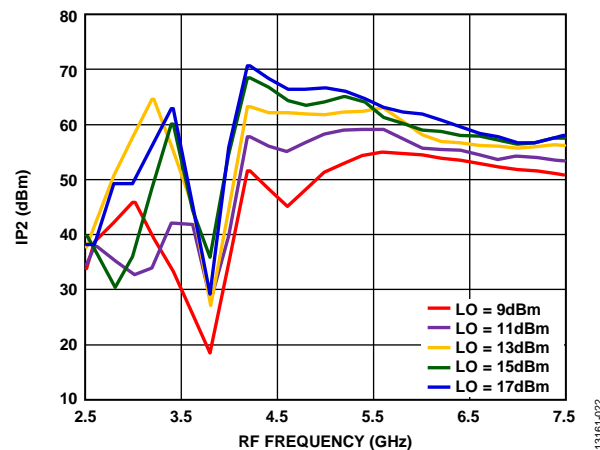

Figure 28. Input IP2 vs. RF Frequency at Various LO Drives

DOWNCONVERTER PERFORMANCE WITH LOWER SIDEBAND SELECTED, IF = 100 MHz

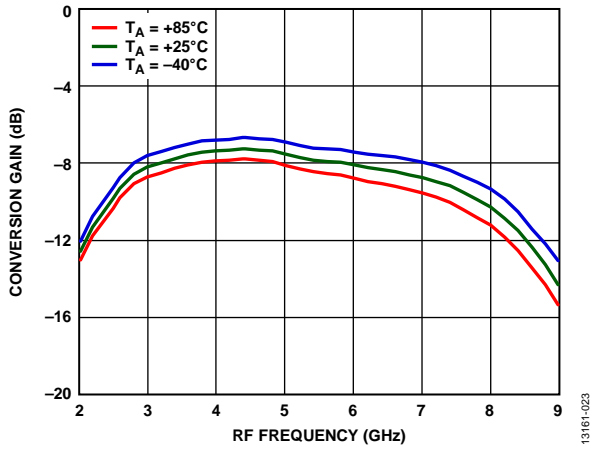

Figure 29. Conversion Gain vs. RF Frequency at Various Temperatures, LO Drive = 15 dBm

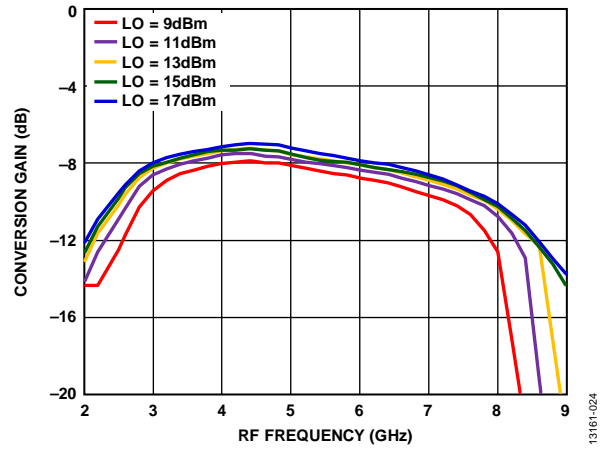

Figure 32. Conversion Gain vs. RF Frequency at Various LO Drives

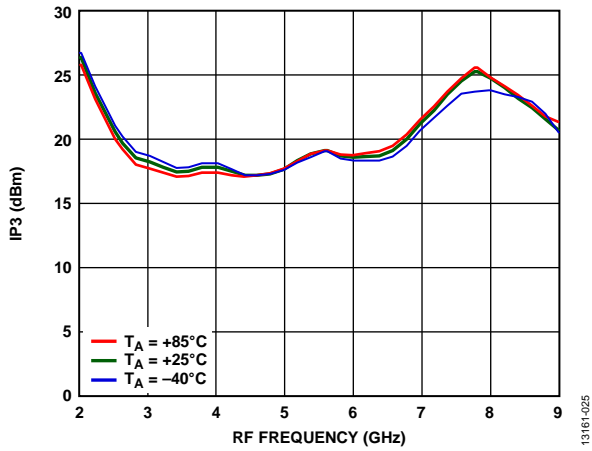

Figure 30. Input IP3 vs. RF Frequency at Various Temperatures, LO Drive = 15 dBm

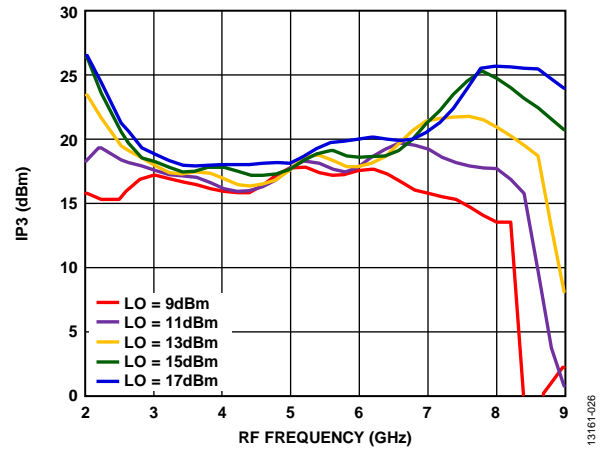

Figure 33. Input IP3 vs. RF Frequency at Various LO Drives

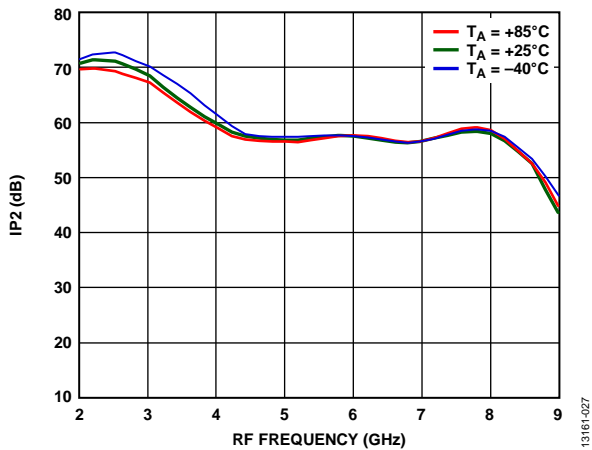

Figure 31. Input IP2 vs. RF Frequency at Various Temperatures, LO Drive = 15 dBm

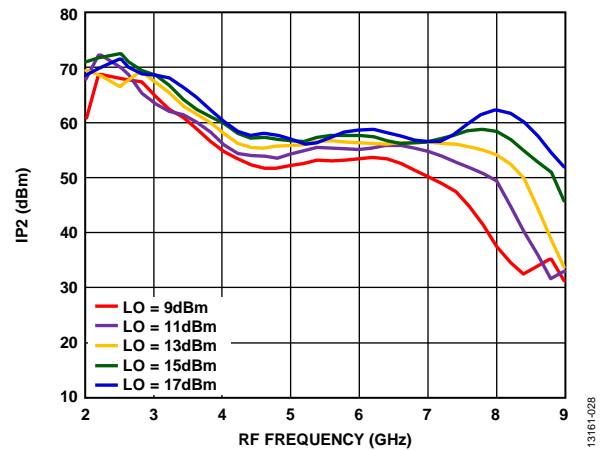

Figure 34. Input IP2 vs. RF Frequency at Various LO Drives

DOWNCONVERTER PERFORMANCE WITH LOWER SIDEBAND SELECTED, IF = 1000 MHz

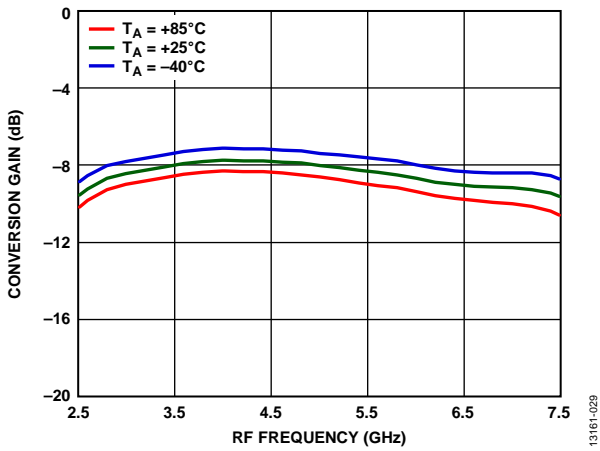

Figure 35. Conversion Gain vs. RF Frequency at Various Temperatures, LO Drive = 15 dBm

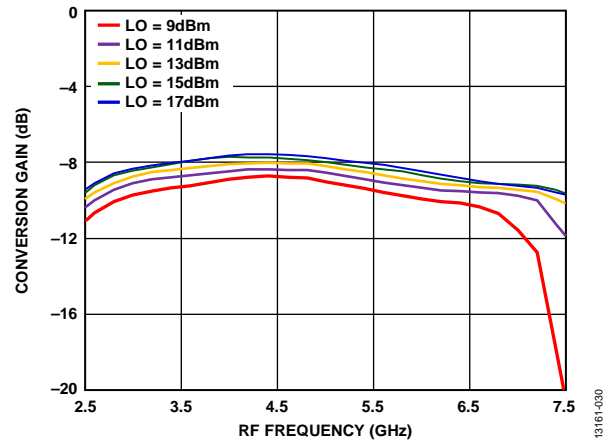

Figure 38. Conversion Gain vs. RF Frequency at Various LO Drives

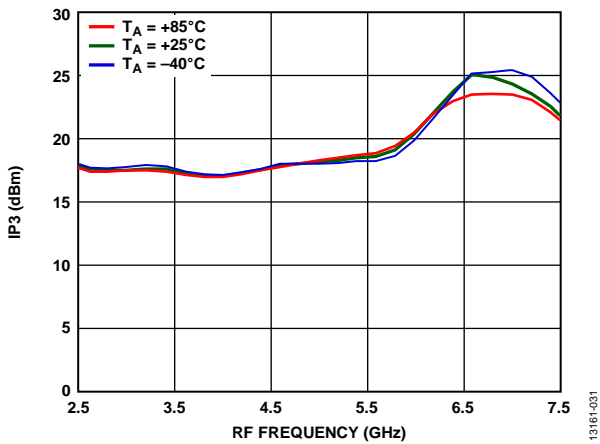

Figure 36. Input IP3 vs. RF Frequency at Various Temperatures, LO Drive = 15 dBm

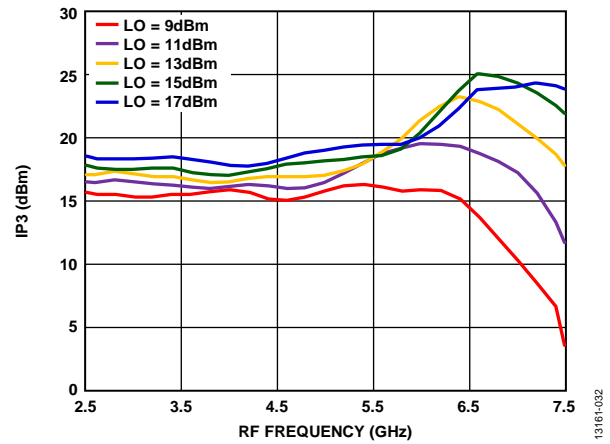

Figure 39. Input IP3 vs. RF Frequency at Various LO Drives

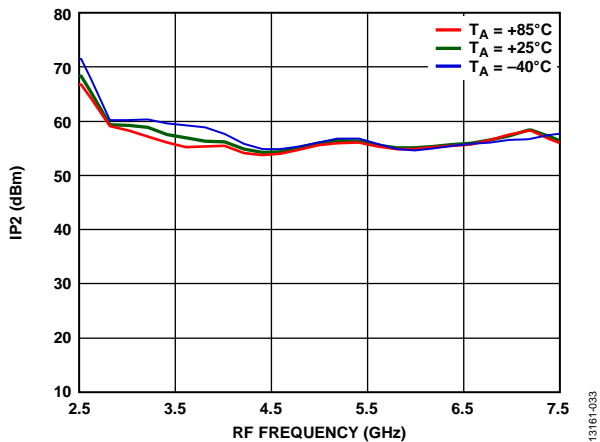

Figure 37. Input IP2 vs. RF Frequency at Various Temperatures, LO Drive = 15 dBm

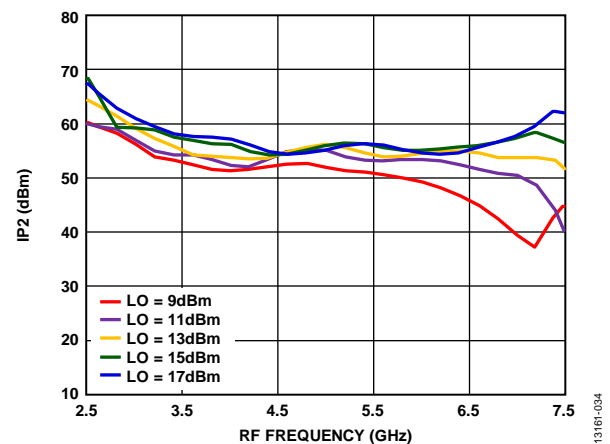

Figure 40. Input IP2 vs. RF Frequency at Various LO Drives

DOWNCONVERTER PERFORMANCE WITH LOWER SIDEBAND SELECTED, IF = 2000 MHz

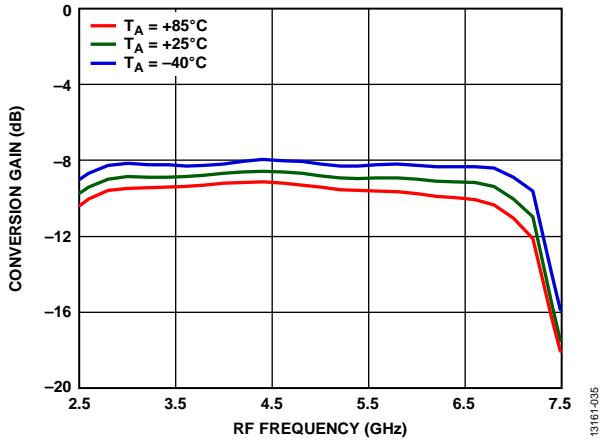

Figure 41. Conversion Gain vs. RF Frequency at Various Temperatures, LO Drive = 15 dBm

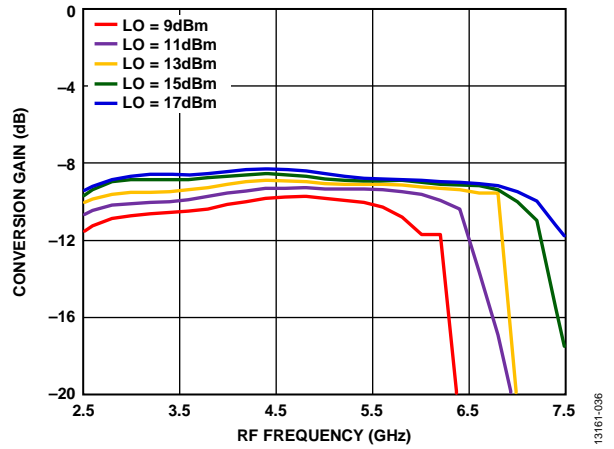

Figure 44. Conversion Gain vs. RF Frequency at Various LO Drives

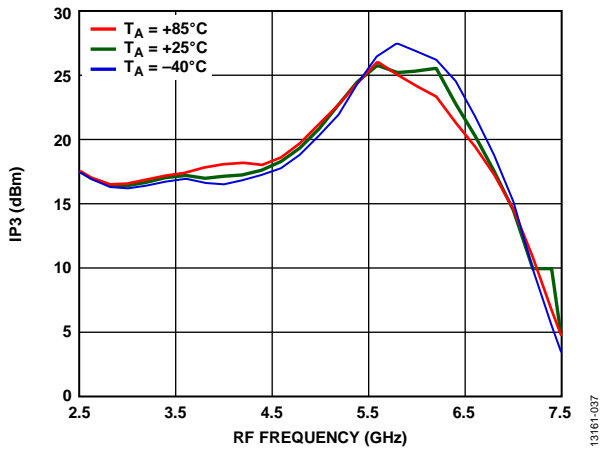

Figure 42. Input IP3 vs. RF Frequency at Various Temperatures, LO Drive = 15 dBm

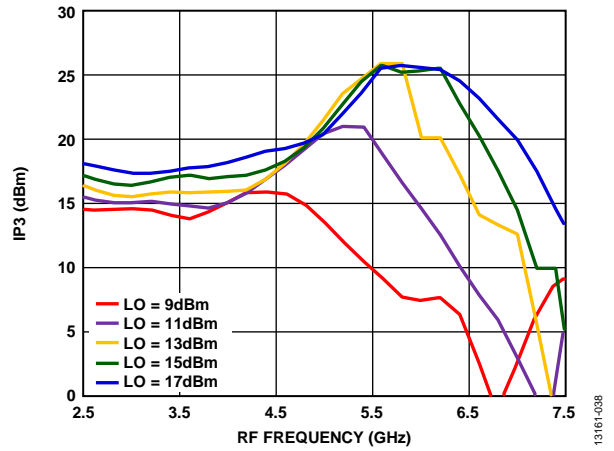

Figure 45. Input IP3 vs. RF Frequency at Various LO Drives

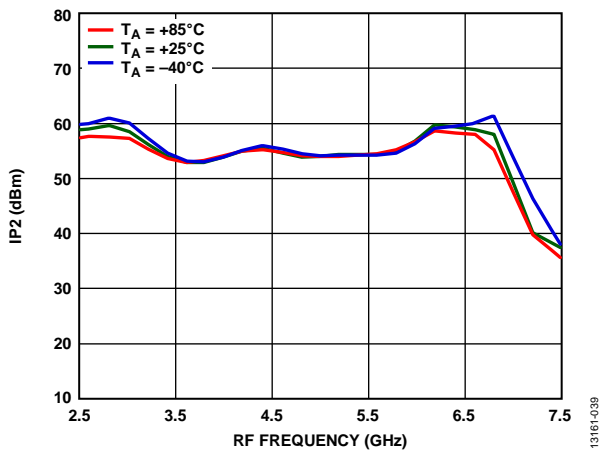

Figure 43. Input IP2 vs. RF Frequency at Various Temperatures, LO Drive = 15 dBm

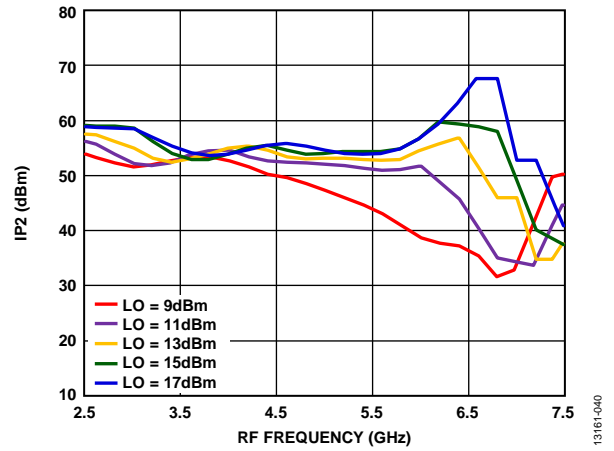

Figure 46. Input IP2 vs. RF Frequency at Various LO Drives

**P1dB PERFORMANCE WITH DOWNCONVERTER MODE SELECTED AT LO DRIVE = 15 dBm**

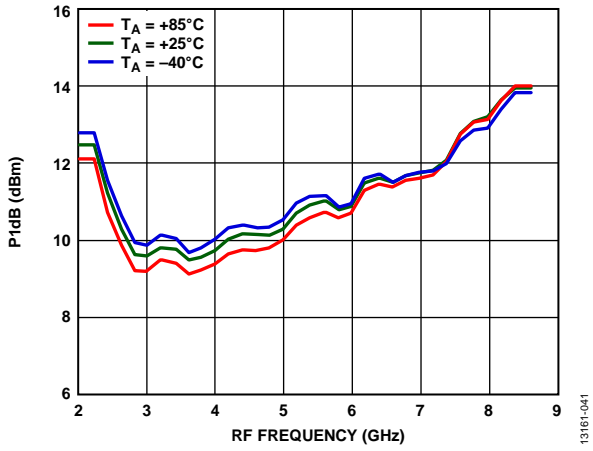

Figure 47. Input P1dB vs. RF Frequency at Various Temperatures, IF = 100 MHz, USB

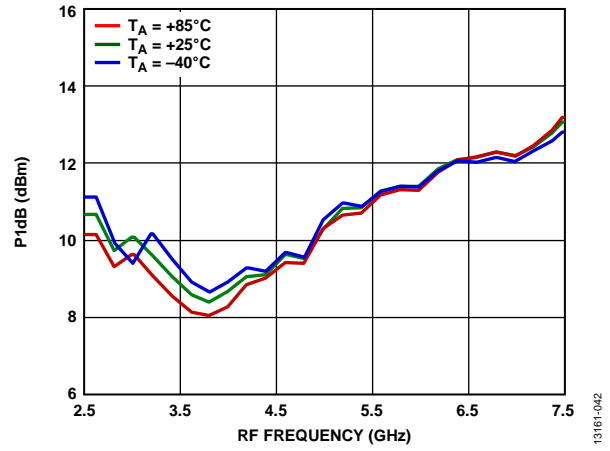

Figure 50. Input P1dB vs. RF Frequency at Various Temperatures, IF = 1000 MHz, USB

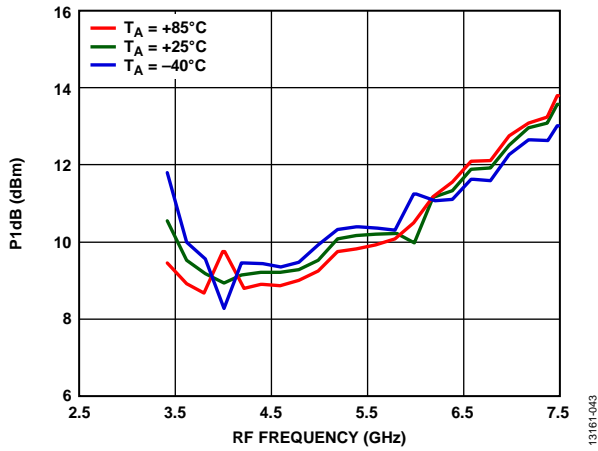

Figure 48. Input P1dB vs. RF Frequency at Various Temperatures, IF = 2000 MHz, USB

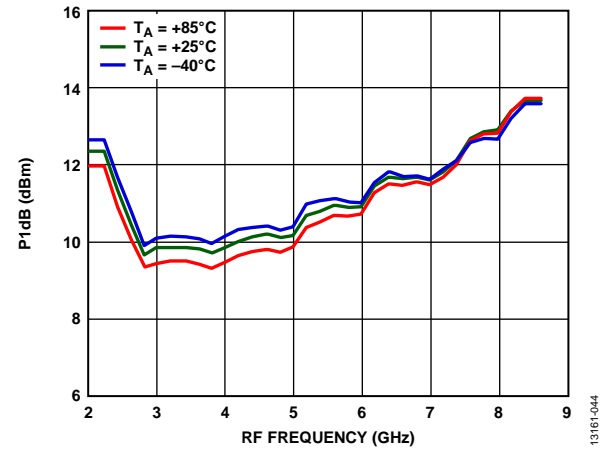

Figure 51. Input P1dB vs. RF Frequency at Various Temperatures, IF = 100 MHz, LSB

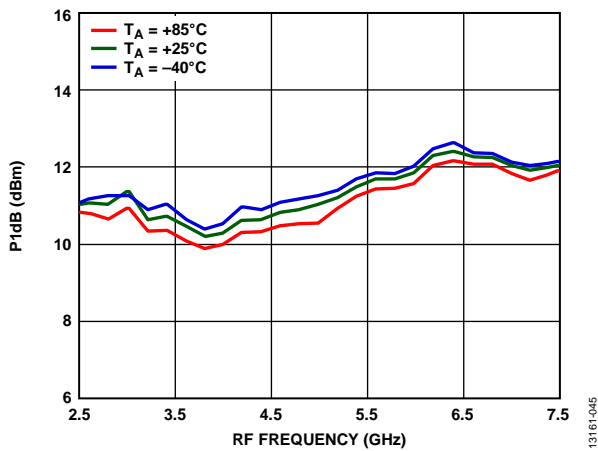

Figure 49. Input P1dB vs. RF Frequency at Various Temperatures, IF = 1000 MHz, LSB

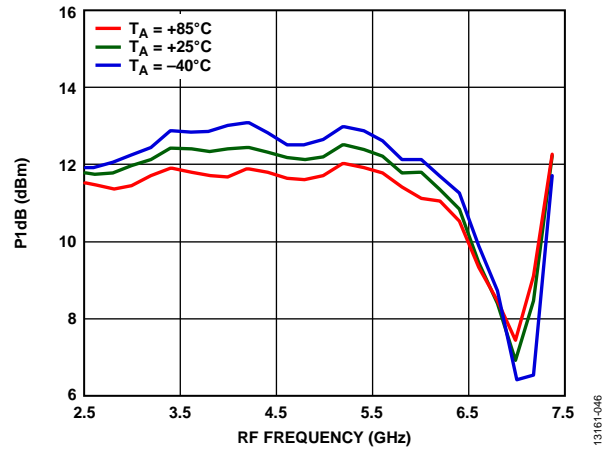

Figure 52. Input P1dB vs. RF Frequency at Various Temperatures, IF = 2000 MHz, LSB

UPCONVERTER PERFORMANCE WITH UPPER SIDEBAND SELECTED, IF = 100 MHz

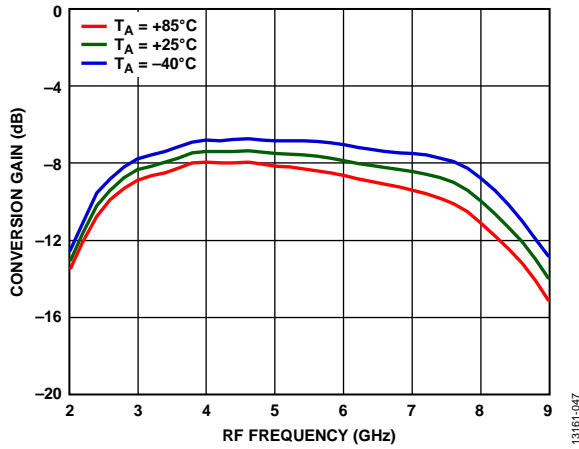

Figure 53. Conversion Gain vs. RF Frequency at Various Temperatures, LO Drive = 15 dBm

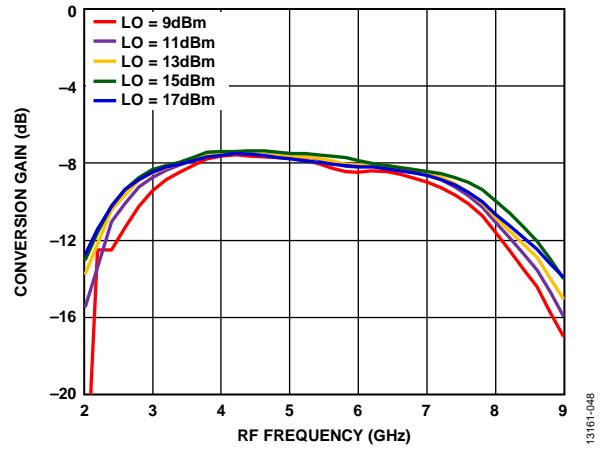

Figure 56. Conversion Gain vs. RF Frequency at Various LO Drives

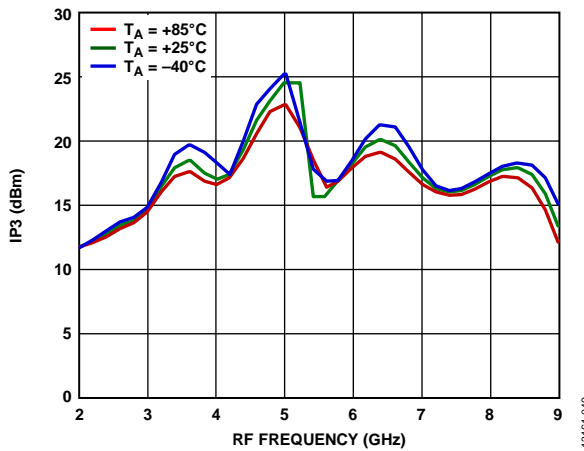

Figure 54. Input IP3 vs. RF Frequency at Various Temperatures, LO Drive = 15 dBm

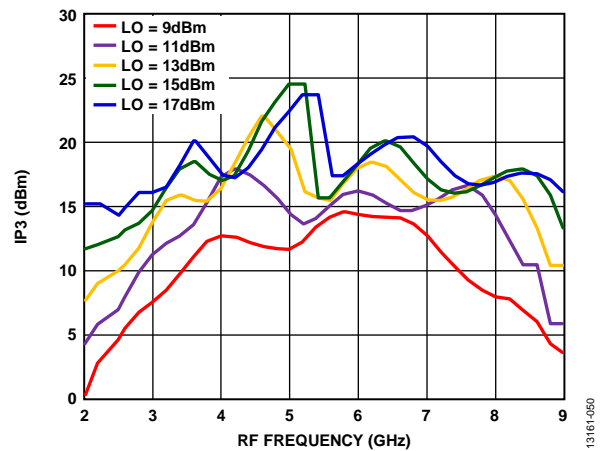

Figure 57. Input IP3 vs. RF Frequency at Various LO Drives

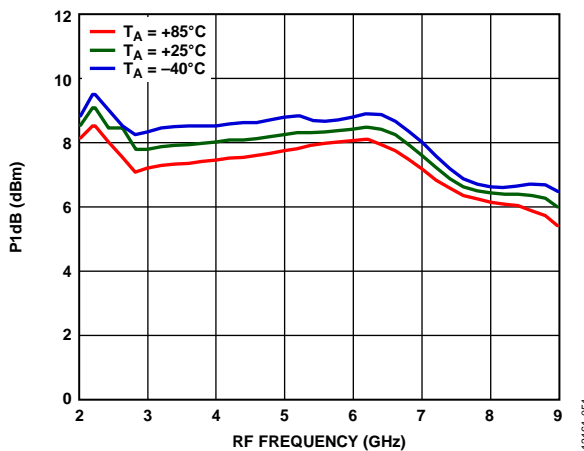

Figure 55. Input P1dB vs. RF Frequency at Various Temperatures, LO Drive = 15 dBm

UPCONVERTER PERFORMANCE WITH UPPER SIDEBAND SELECTED, IF = 1000 MHz

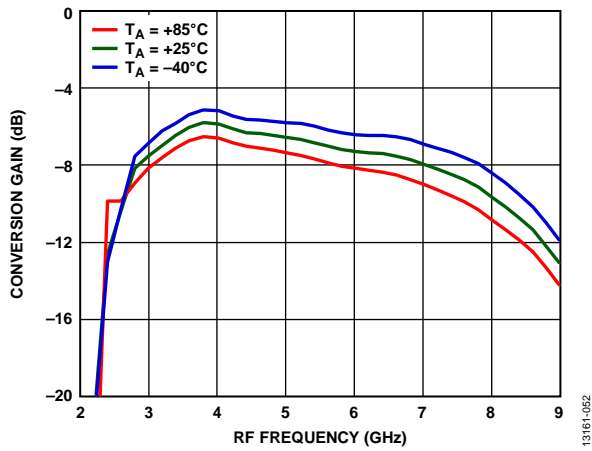

Figure 58. Conversion Gain vs. RF Frequency at Various Temperatures, LO Drive = 15 dBm

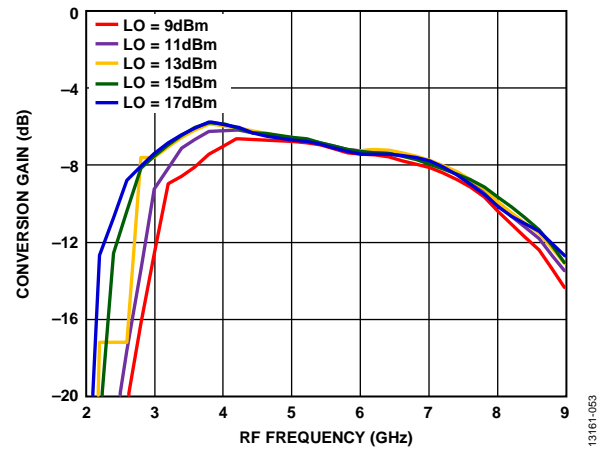

Figure 61. Conversion Gain vs. RF Frequency at Various LO Drives

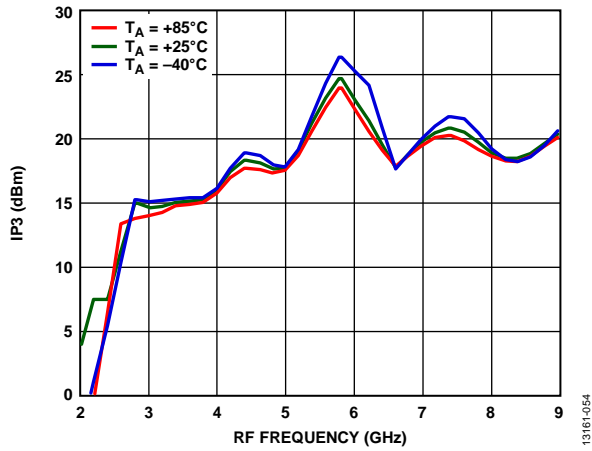

Figure 59. Input IP3 vs. RF Frequency at Various Temperatures, LO Drive = 15 dBm

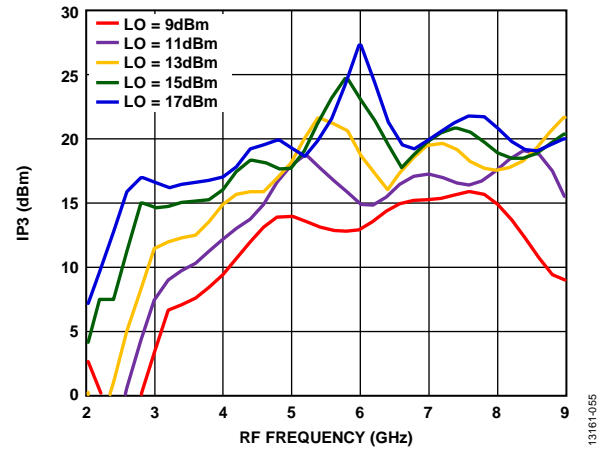

Figure 62. Input IP3 vs. RF Frequency at Various LO Drives

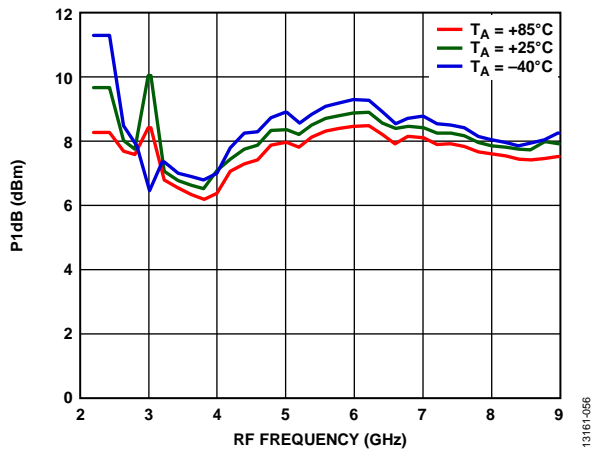

Figure 60. Input P1dB vs. RF Frequency at Various Temperatures, LO Drive = 15 dBm



UPCONVERTER PERFORMANCE WITH UPPER SIDEBAND SELECTED, IF = 2000 MHz

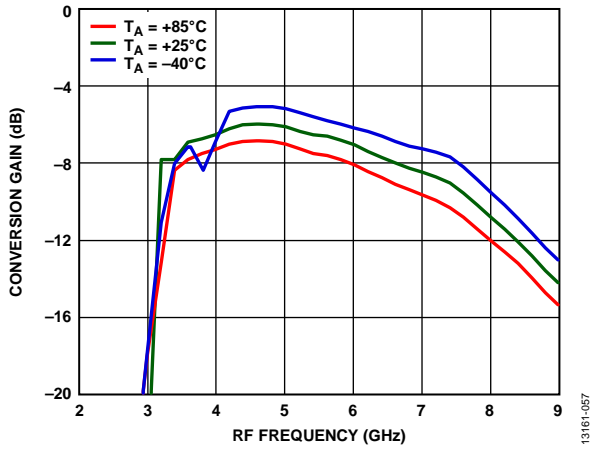

Figure 63. Conversion Gain vs. RF Frequency at Various Temperatures, LO Drive = 15 dBm

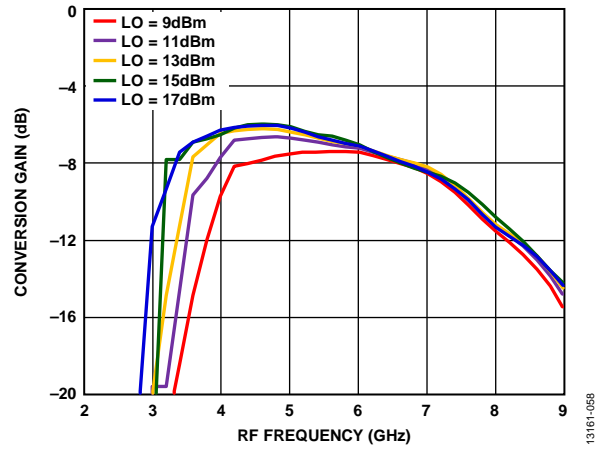

Figure 66. Conversion Gain vs. RF Frequency at Various LO Drives

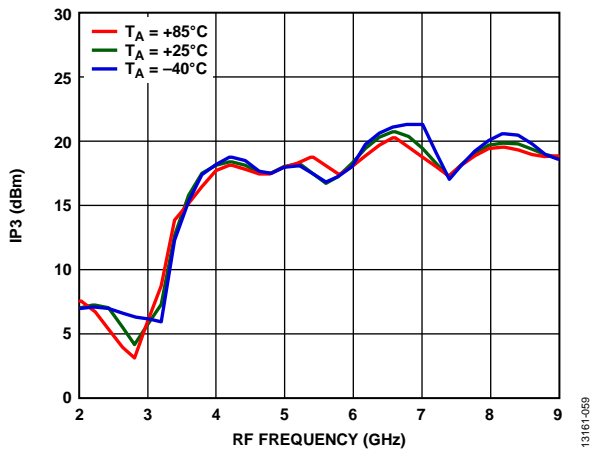

Figure 64. Input IP3 vs. RF Frequency at Various Temperatures, LO Drive = 15 dBm

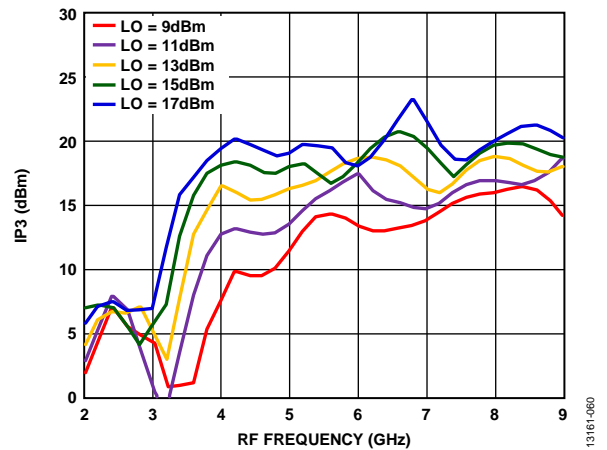

Figure 67. Input IP3 vs. RF Frequency at Various LO Drives

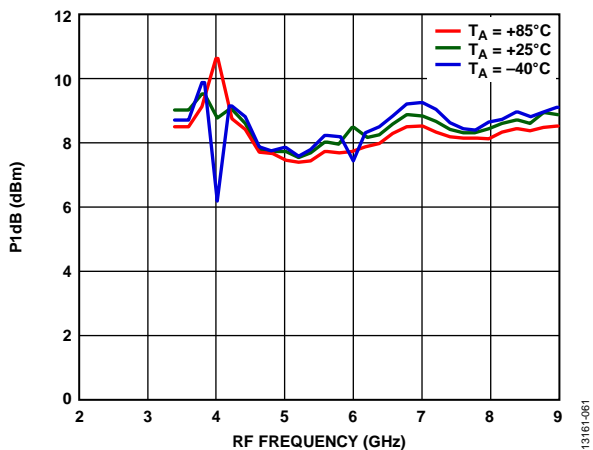

Figure 65. Input P1dB vs. RF Frequency at Various Temperatures, LO Drive = 15 dBm

## UPCONVERTER PERFORMANCE WITH LOWER SIDEBAND SELECTED, IF = 100 MHz

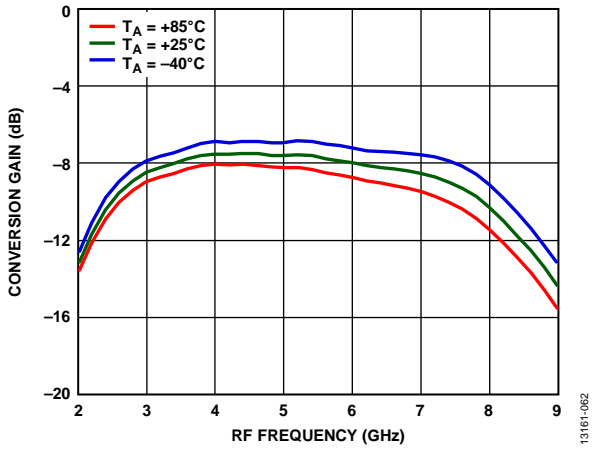

Figure 68. Conversion Gain vs. RF Frequency at Various Temperatures, LO Drive = 15 dBm

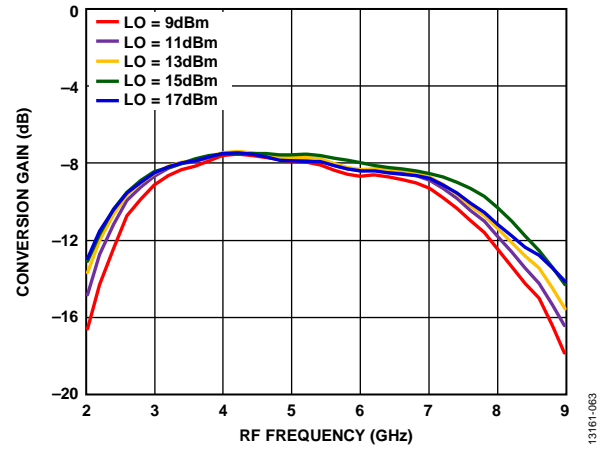

Figure 71. Conversion Gain vs. RF Frequency at Various LO Drives

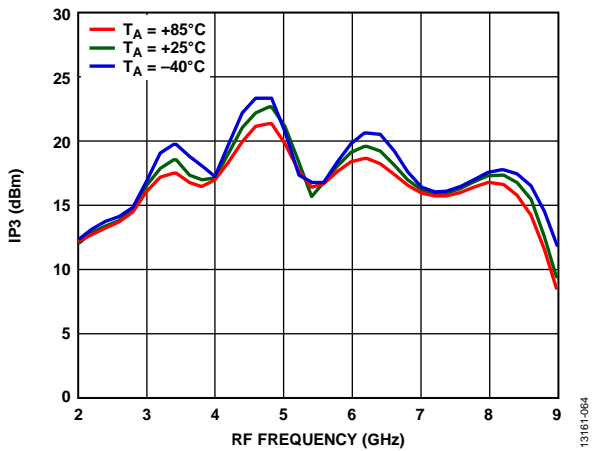

Figure 69. Input IP3 vs. RF Frequency at Various Temperatures, LO Drive = 15 dBm

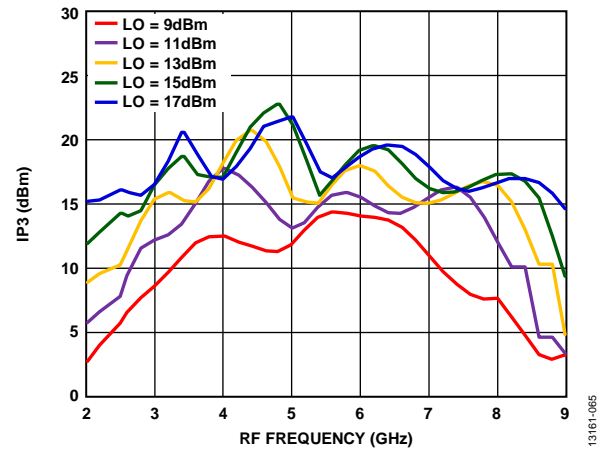

Figure 72. Input IP3 vs. RF Frequency at Various LO Drives

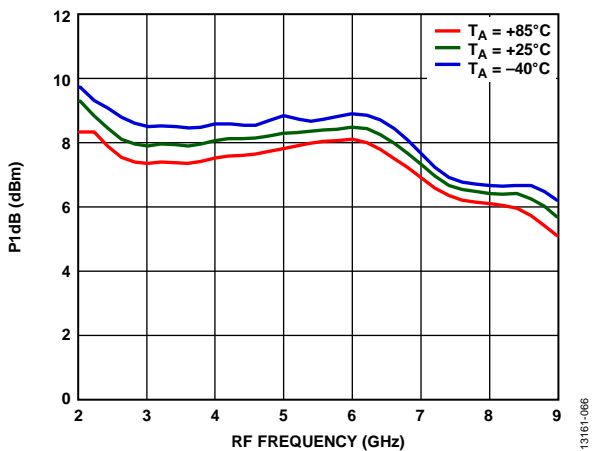

Figure 70. Input P1dB vs. RF Frequency at Various Temperatures, LO Drive = 15 dBm

UPCONVERTER PERFORMANCE WITH LOWER SIDEBAND SELECTED, IF = 1000 MHz

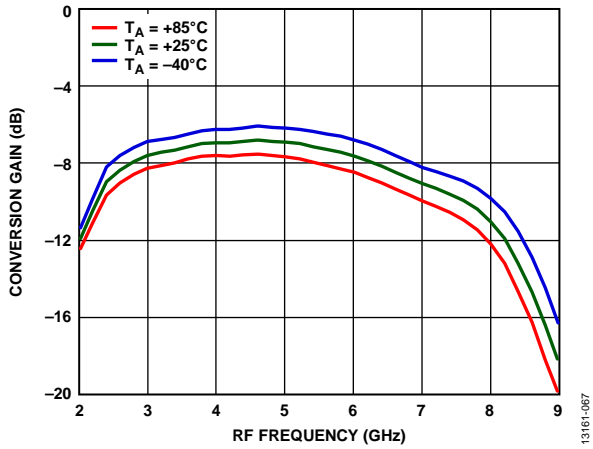

Figure 73. Conversion Gain vs. RF Frequency at Various Temperatures, LO Drive = 15 dBm

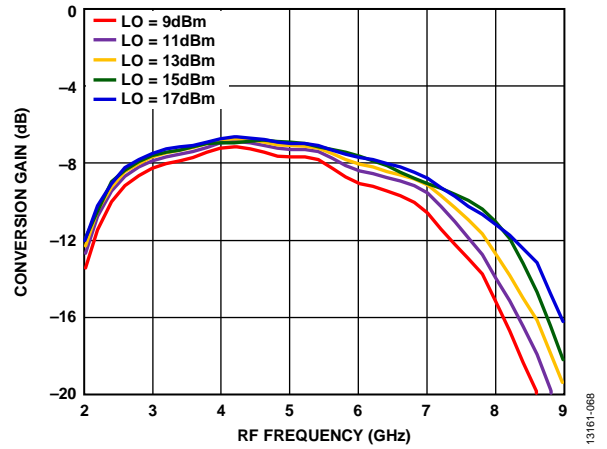

Figure 76. Conversion Gain vs. RF Frequency at Various LO Drives

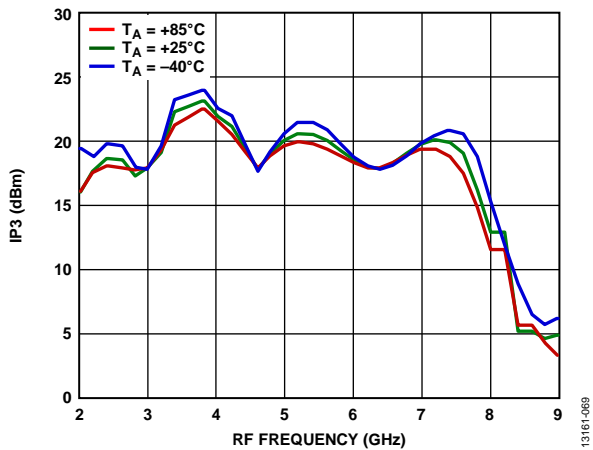

Figure 74. Input IP3 vs. RF Frequency at Various Temperatures, LO Drive = 15 dBm

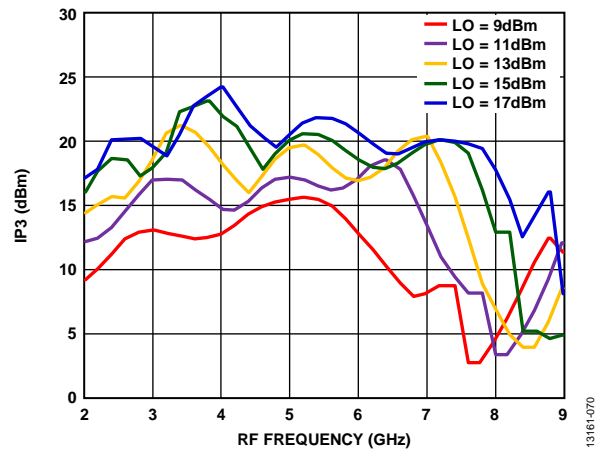

Figure 77. Input IP3 vs. RF Frequency at Various LO Drives

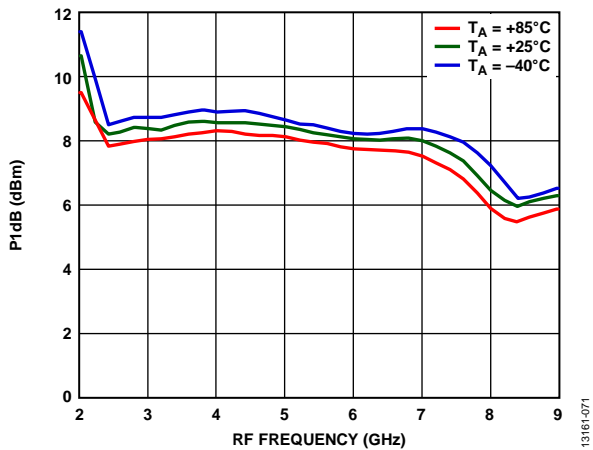

Figure 75. Input P1dB vs. RF Frequency at Various Temperatures, LO Drive = 15 dBm

UPCONVERTER PERFORMANCE WITH LOWER SIDEBAND SELECTED, IF = 2000 MHz

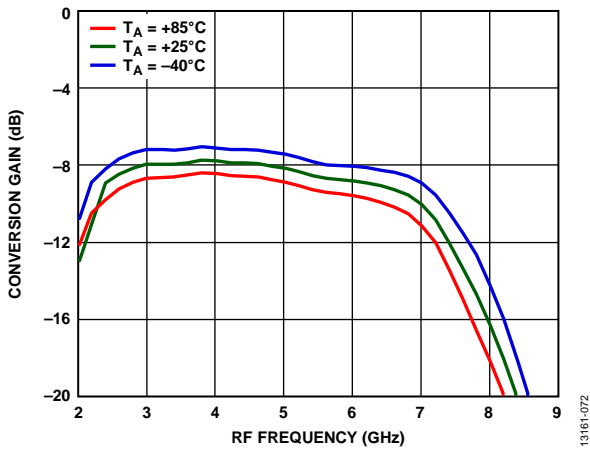

Figure 78. Conversion Gain vs. RF Frequency at Various Temperatures, LO Drive = 15 dBm

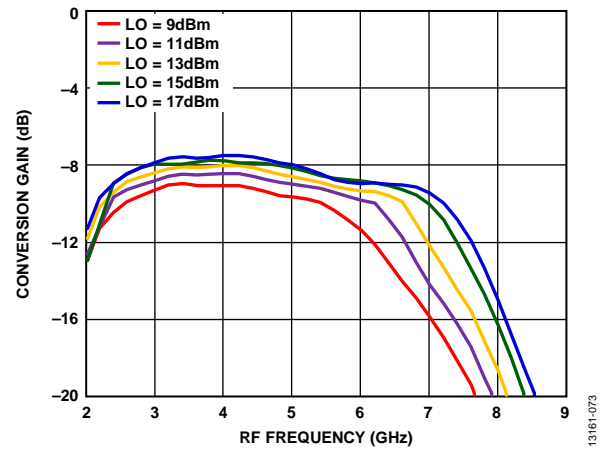

Figure 81. Conversion Gain vs. RF Frequency at Various LO Drives

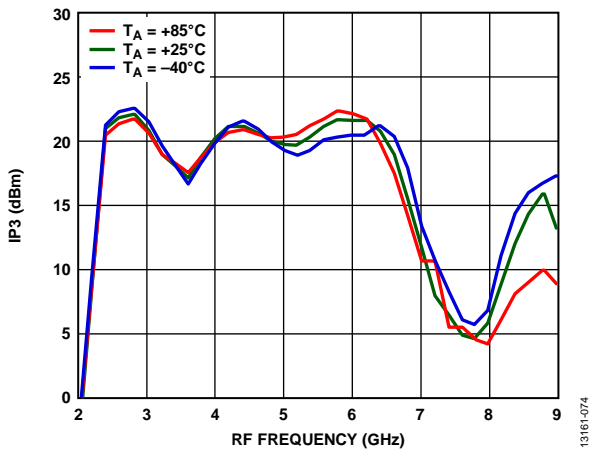

Figure 79. Input IP3 vs. RF Frequency at Various Temperatures, LO Drive = 15 dBm

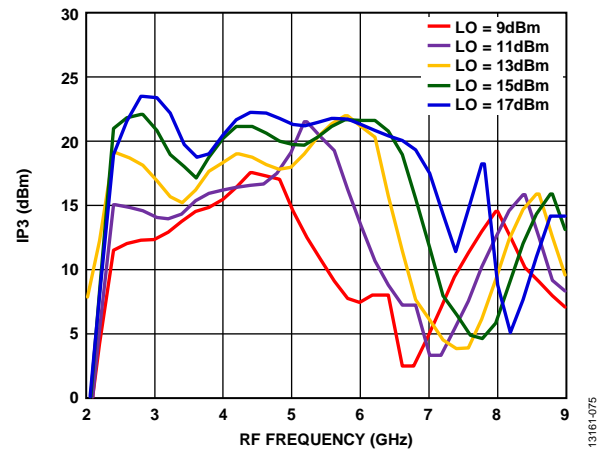

Figure 82. Input IP3 vs. RF Frequency at Various LO Drives

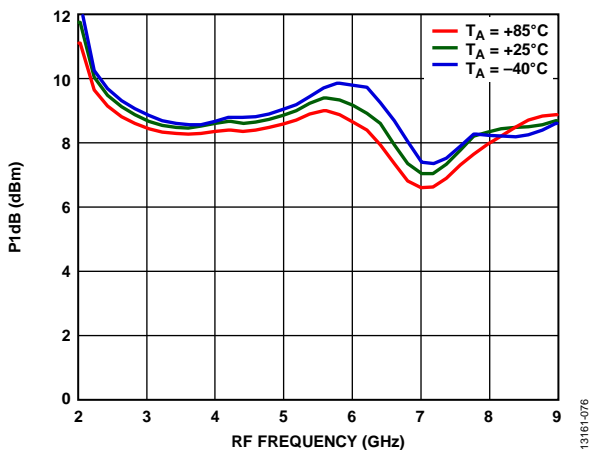

Figure 80. Input P1dB vs. RF Frequency at Various Temperatures, LO Drive = 15 dBm

**SPURIOUS PERFORMANCE WITH UPPER SIDEBAND SELECTED, IF = 100 MHz**

Mixer spurious products are measured in dBc from the IF output power level. Spur values are  $(M \times RF) - (N \times LO)$ .

***M × N Spurious Outputs***

RF frequency = 5 GHz, RF input power = -10 dBm, LO frequency = 4.9 GHz, LO drive = 15 dBm.

		<b>N × LO</b>					
		<b>0</b>	<b>1</b>	<b>2</b>	<b>3</b>	<b>4</b>	<b>5</b>
<b>M × RF</b>	<b>0</b>	N/A <sup>1</sup>	+3.6	+33.3	+25.2	+43.3	+28.6
	<b>1</b>	+15.9	+0.00	+31.7	+38.1	+60.8	+73.4
	<b>2</b>	+74.8	+64.7	+61.2	+63.6	+79.5	+75.1
	<b>3</b>	+74.2	+78.6	+80.8	+72	+78.5	+79.2
	<b>4</b>	+73.2	+77.5	+75.3	+78	+90.7	+79.3
	<b>5</b>	-92.8	+72.7	+76.7	+77.6	+81.3	+88.9

<sup>1</sup> N/A means not applicable.

APPLICATIONS INFORMATION

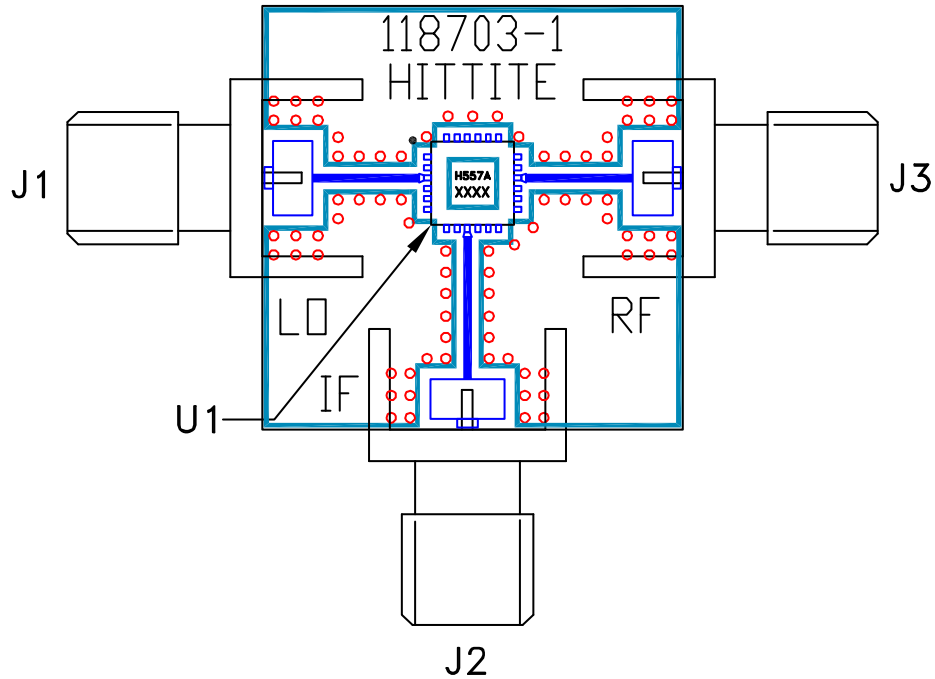

Figure 83. Evaluation Printed Circuit Board (PCB)

13161-082

Table 5. List of Materials for Evaluation PCB EV1HMC557ALC4<sup>1</sup>

Item	Description
J1, J2, J3	Johnson SMA connector
U1	HMC557ALC4 mixer
PCB <sup>2</sup>	118703 evaluation PCB <sup>3</sup>

<sup>1</sup> Reference this number when ordering the complete evaluation PCB.

<sup>2</sup> The circuit board material is Rogers 4350.

<sup>3</sup> This is the bare PCB of the evaluation PCB kit (see Figure 83).

It is recommended that the application circuit board use RF circuit design techniques. Use signal lines with a 50 Ω impedance, and connect the package ground leads and exposed pad directly to the ground plane. Use a sufficient number of via holes to connect the top and bottom ground planes. The evaluation circuit board shown in Figure 83 is available from Analog Devices, Inc., upon request.

# OUTLINE DIMENSIONS

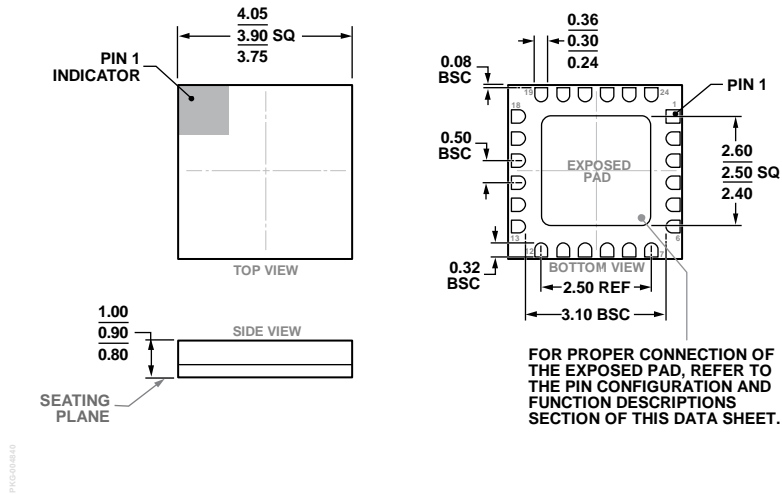

Figure 84. 24-Terminal Ceramic Leadless Chip Carrier [LCC] (E-24-1)  
Dimensions shown in millimeters

## ORDERING GUIDE

Model <sup>1</sup>	Temperature Range	Package Body Material	Lead Finish	MSL Rating <sup>2</sup>	Package Description	Package Option
HMC557ALC4	-40°C to +85°C	Alumina Ceramic	Gold over Nickel	MSL3	24-Terminal Ceramic LCC	E-24-1
HMC557ALC4TR	-40°C to +85°C	Alumina Ceramic	Gold over Nickel	MSL3	24-Terminal Ceramic LCC	E-24-1
HMC557ALC4TR-R5	-40°C to +85°C	Alumina Ceramic	Gold over Nickel	MSL3	24-Terminal Ceramic LCC	E-24-1
EV1HMC557ALC4					Evaluation Board	

<sup>1</sup> All models are RoHS Compliant parts.

<sup>2</sup> Maximum peak reflow temperature of 260°C.