

## GaAs MMIC I/Q DOWNCONVERTER 20 - 28 GHz



### Typical Applications

The HMC977LP4E is ideal for:

- Point-to-Point and Point-to-Multi-Point Radios
- Military Radar, EW & ELINT
- Satellite Communications

### Features

- Conversion Gain: 14 dB
- Image Rejection: 21 dBc
- 2x LO to RF Isolation: 45 dB
- Noise Figure: 2.5 dB
- Input Third-Order Intercept: 1 dBm
- LO Drive Range: 2 to 6 dBm
- 24 Lead 4 mm x 4 mm SMT Package

### Functional Diagram

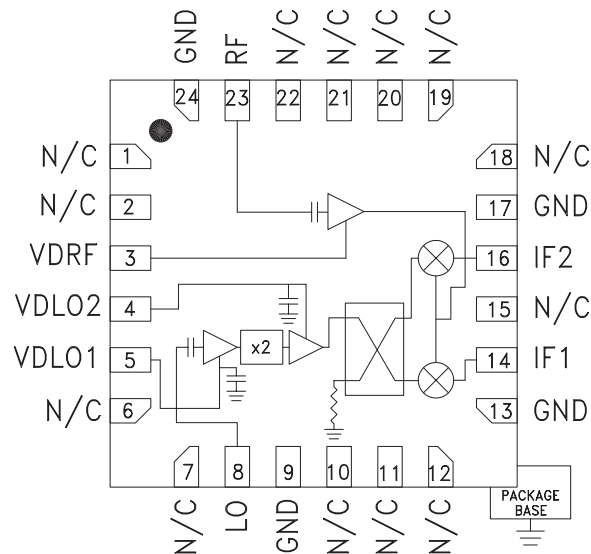

### General Description

The HMC977LP4E is a compact GaAs MMIC I/Q downconverter in a leadless RoHS compliant SMT package. This device provides a small signal conversion gain of 14 dB with a noise figure of 2.5 dB and 21 dBc of image rejection. The HMC977LP4E utilizes a low noise amplifier (LNA) followed by an image reject mixer which is driven by an active 2x multiplier. The image reject mixer eliminates the need for a filter following the LNA and removes thermal noise at the image frequency. I and Q mixer outputs are provided and an external 90° hybrid is needed to select the required sideband. The HMC977LP4E is a much smaller alternative to hybrid style image reject mixer downconverter assemblies, and is compatible with surface mount manufacturing techniques.

### Electrical Specifications, $T_A = +25^\circ\text{C}$ , $IF = 1000\text{ MHz}$ , $LO = 6\text{ dBm}$ , $V_{dd} = 3.5\text{ Vdc}$ , USB <sup>[1]</sup>

Parameter	Min.	Typ.	Max.	Min.	Typ.	Max.	Units
RF Frequency Range	20		26.5	26.5		28	GHz
LO Frequency Range	8.3		15	11.5		15.7	GHz
IF Frequency Range	DC		3.5	DC		3.5	GHz
LO Drive Range	2		6	2		6	dBm
Conversion Gain (As IRM)	11	14		11	14		dB
Noise Figure		2.5			3.0		dB
Image Rejection		21			20		dBc
Input Power for 1 dB Compression (P1dB)		-8			-7		dBm
2x LO to RF Isolation	35	45		34	39		dB
2x LO to IF Isolation		20			30		dB
Input Third-Order Intercept (IP3)		1			3		dBm
Amplitude Balance <sup>[2]</sup>		0.3			0.3		dB
Phase Balance <sup>[2]</sup>		17			12		Degree
Total Supply Current		170	210		170	210	mA

[1] Unless otherwise noted all measurements performed as downconverter with upper sideband selected and external 90° hybrid at the IF ports.

[2] Data taken without external 90° hybrid at the IF ports.



**GaAs MMIC I/Q DOWNCONVERTER  
20 - 28 GHz**

Data Taken As IRM With External 90° Hybrid at The IF Ports, IF = 1000 MHz, USB

**Conversion Gain vs. RF Frequency Over Temperature, LO Drive = 6 dBm**

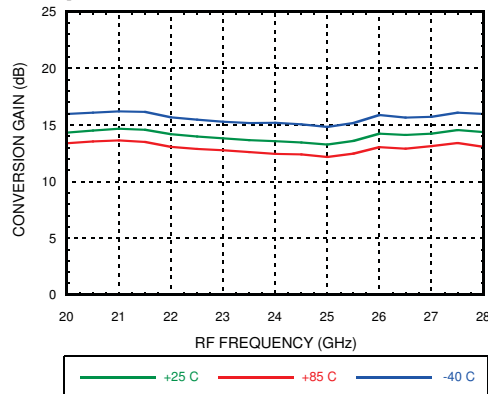

**Conversion Gain vs. RF Frequency at Various LO Drives**

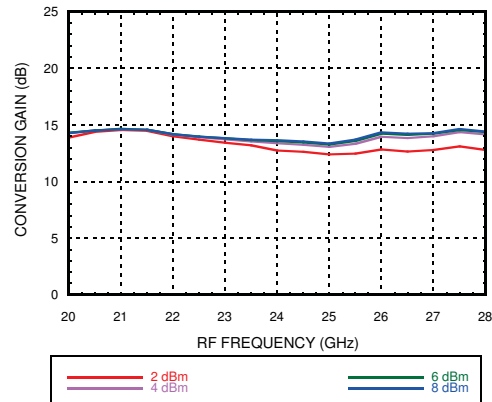

**Image Rejection vs. RF Frequency Over Temperature, LO Drive = 6 dBm**

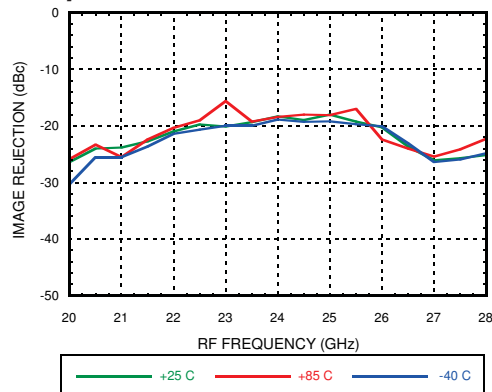

**RF Return Loss vs. RF Frequency Over Temperature, LO Frequency = 24 GHz**

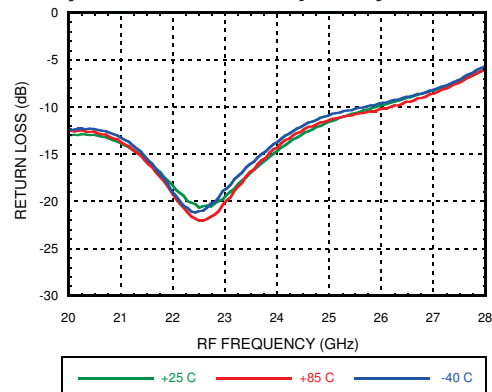

**LO Return Loss vs. LO Frequency Over Temperature, LO Drive = 6 dBm**

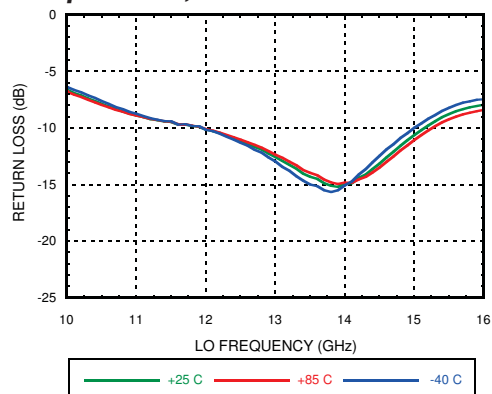

**IF Return Loss vs. IF Frequency [1]  
LO Frequency = 24 GHz, LO Drive = 6 dBm**

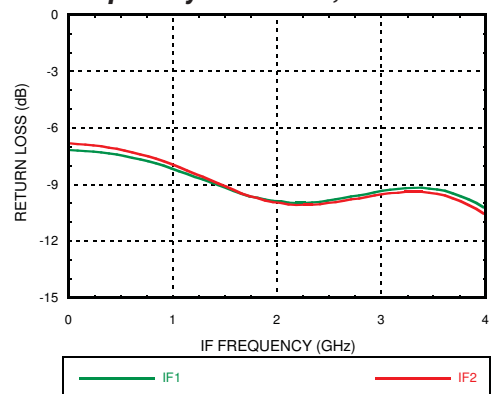

[1] Data taken without external 90° hybrid

**GaAs MMIC I/Q DOWNCONVERTER  
20 - 28 GHz**



Data Taken As IRM With External 90° Hybrid at The IF Ports, IF = 1000 MHz, USB

**RF to IF and LO to IF Isolation [1]  
vs. RF Frequency, LO Drive = 6 dBm**

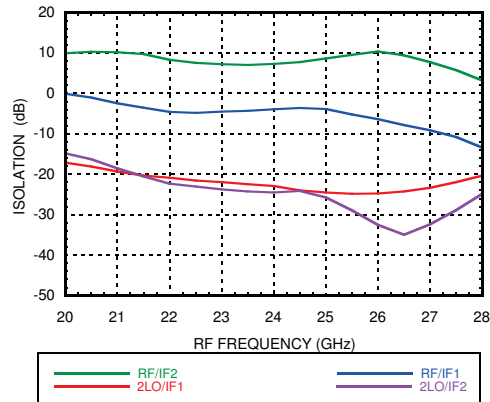

**LO to RF Isolation vs. RF Frequency [1]  
LO Drive = 6 dBm**

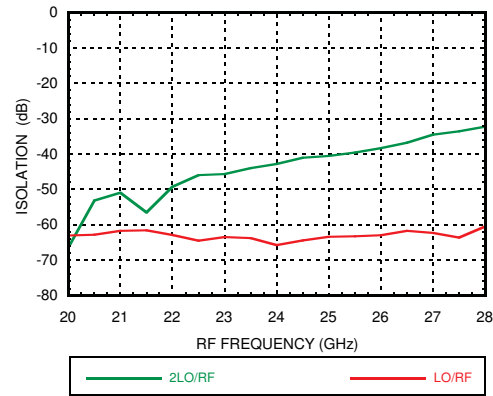

**Input P1dB vs. RF Frequency Over  
Temperature, LO Drive = 6 dBm**

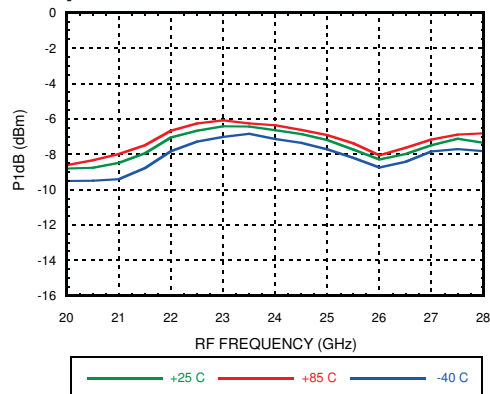

**Input IP3 vs. RF Frequency Over  
Temperature, LO Drive = 6 dBm**

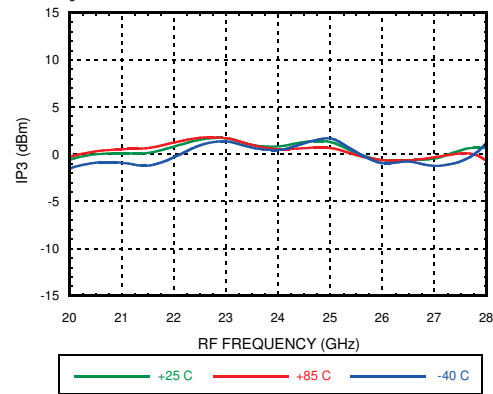

**Input IP3 vs. RF Frequency at  
Various LO Drives**

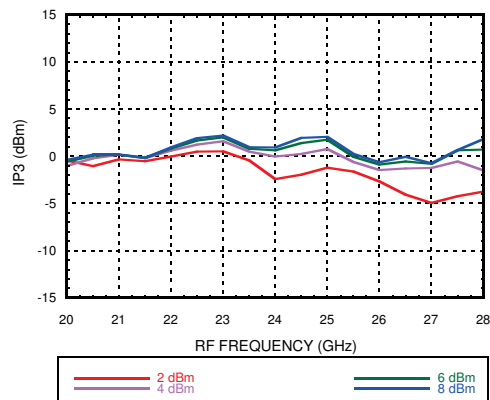

**Noise Figure vs. IF Frequency, LO  
Frequency = 10 GHz, LO Drive = 6 dBm [1]**

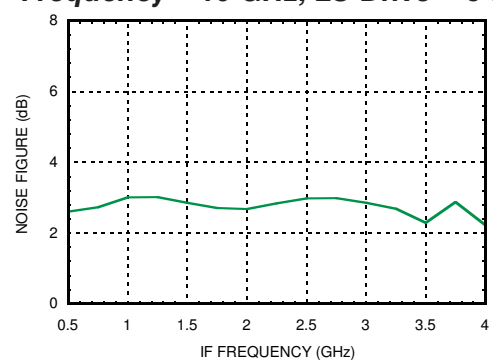

[1] Data taken without external IF 90° hybrid



**GaAs MMIC I/Q DOWNCONVERTER  
20 - 28 GHz**

**Quadrature Channel Data Taken Without 90° Hybrid at The IF Ports, IF = 1000 MHz, USB**

**Noise Figure vs. RF Frequency Over Temperature, LO Drive = 6 dBm**

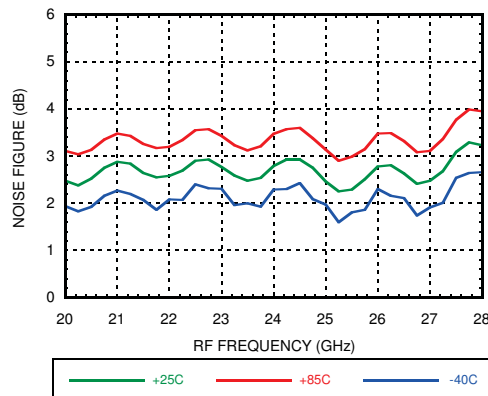

**Conversion Gain and Return Loss Over IF Bandwidth**

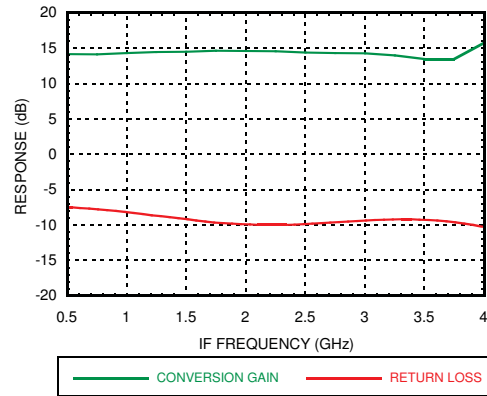

**Amplitude Balance vs. RF Frequency at Various LO Drives**

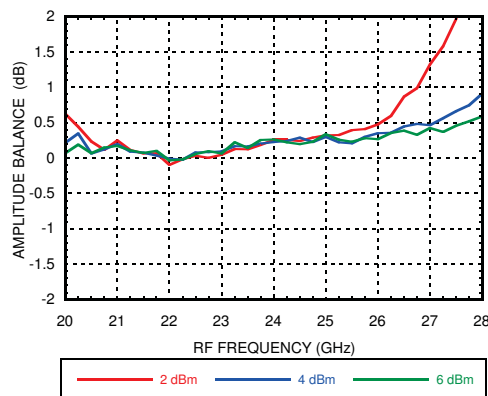

**Phase Balance vs. RF Frequency at Various LO Drives**

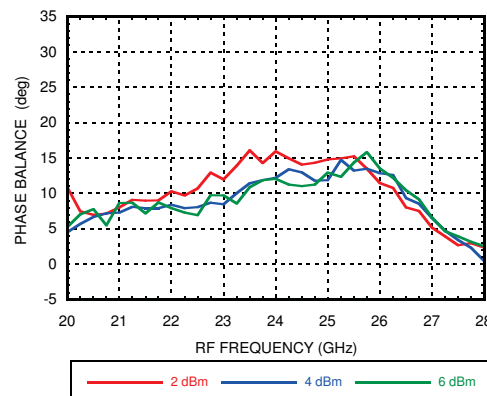

**M x N Spurious Outputs, IF = 1000MHz**

mRF	nLO				
	0	1	2	3	4
0	x	-22.6	-7.4	-28.8	-37.2
1	-20	-29.3	0	-33	-37.3
2	-72.6	-72.6	-57.6	-43.6	-51.6
3	x	x	-74.6	-74.6	-74.6
4	x	x	x	x	x

RF = 24 GHz, RF Input Power = -20 dBm  
 LO Frequency = 11.5 GHz, LO Drive = 4 dBm  
 All values are in dBc below IF power level (RF -2 x LO)  
 Spur values are (M x RF) - (N x LO)

Information furnished by Analog Devices is believed to be accurate and reliable. However, no responsibility is assumed by Analog Devices for its use, nor for any infringements of patents or other rights of third parties that may result from its use. Specifications subject to change without notice. No license is granted by implication or otherwise under any patent or patent rights of Analog Devices. Trademarks and registered trademarks are the property of their respective owners.

For price, delivery, and to place orders: Analog Devices, Inc., One Technology Way, P.O. Box 9106, Norwood, MA 02062-9106  
 Phone: 781-329-4700 • Order online at [www.analog.com](http://www.analog.com)  
 Application Support: Phone: 1-800-ANALOG-D



**GaAs MMIC I/Q DOWNCONVERTER  
20 - 28 GHz**

Data Taken As IRM With External 90° Hybrid at The IF Ports, IF = 1000 MHz, LSB

**Conversion Gain vs. RF Frequency Over Temperature, LO Drive = 6 dBm**

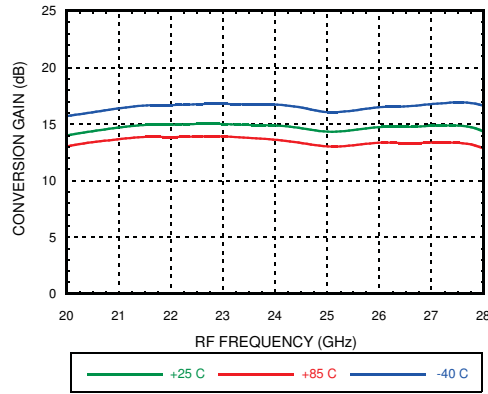

**Conversion Gain vs. RF Frequency at Various LO Drives**

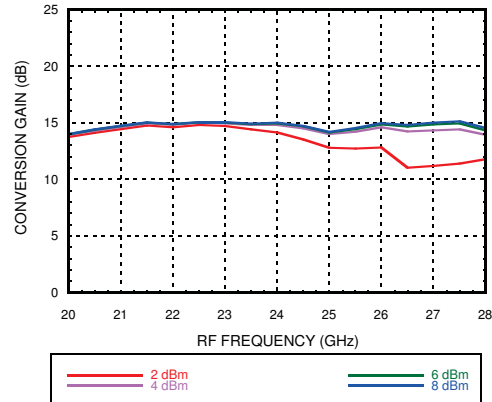

**Image Rejection vs. RF Frequency Over Temperature, LO Drive = 6 dBm**

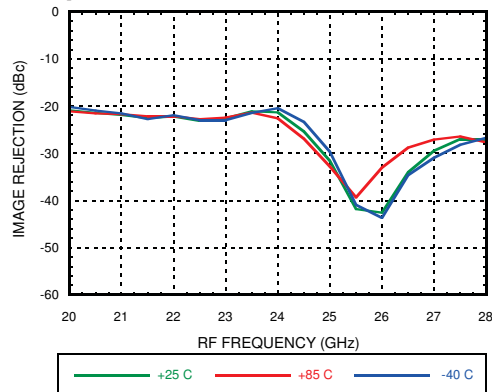

**Input P1dB vs. RF Frequency Over Temperature, LO Drive = 6 dBm**

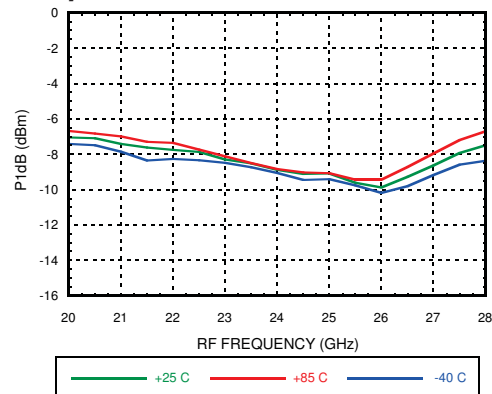

**Input IP3 vs. RF Frequency Over Temperature, LO Drive = 6 dBm**

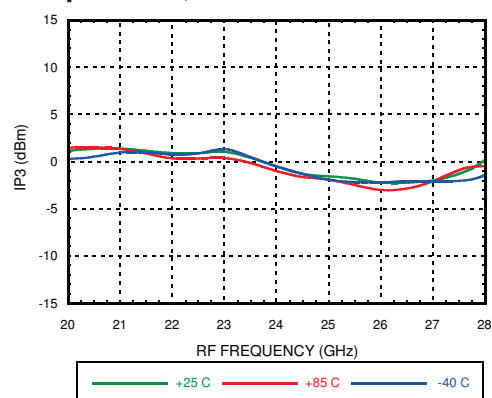

**Input IP3 vs. RF Frequency at Various LO Drives**

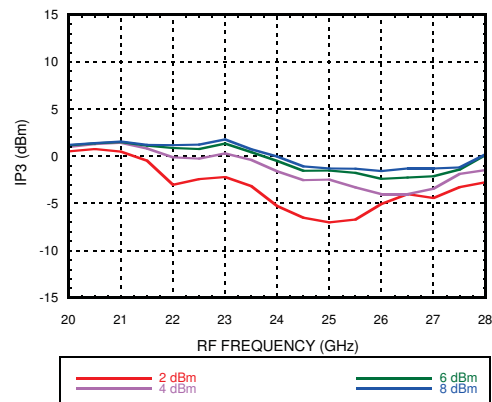

Information furnished by Analog Devices is believed to be accurate and reliable. However, no responsibility is assumed by Analog Devices for its use, nor for any infringements of patents or other rights of third parties that may result from its use. Specifications subject to change without notice. No license is granted by implication or otherwise under any patent or patent rights of Analog Devices. Trademarks and registered trademarks are the property of their respective owners.

For price, delivery, and to place orders: Analog Devices, Inc., One Technology Way, P.O. Box 9106, Norwood, MA 02062-9106 Phone: 781-329-4700 • Order online at [www.analog.com](http://www.analog.com) Application Support: Phone: 1-800-ANALOG-D



**GaAs MMIC I/Q DOWNCONVERTER  
20 - 28 GHz**

Data Taken As IRM With External 90° Hybrid at The IF Ports, IF = 2000 MHz, USB

**Conversion Gain vs. RF Frequency Over Temperature, LO Drive = 6 dBm**

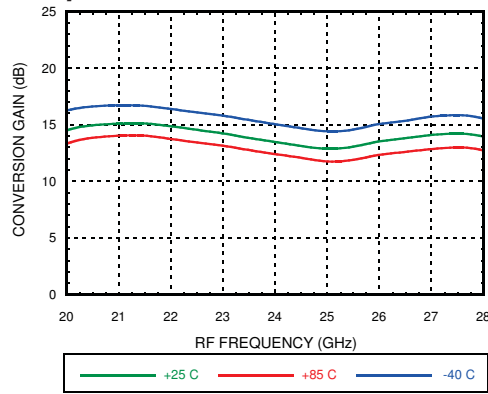

**Conversion Gain vs. RF Frequency at Various LO Drives**

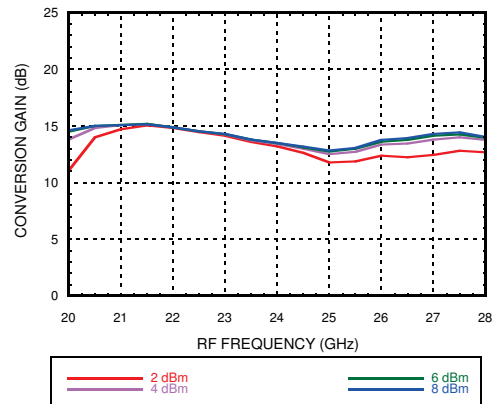

**Image Rejection vs. RF Frequency Over Temperature, LO Drive = 6 dBm**

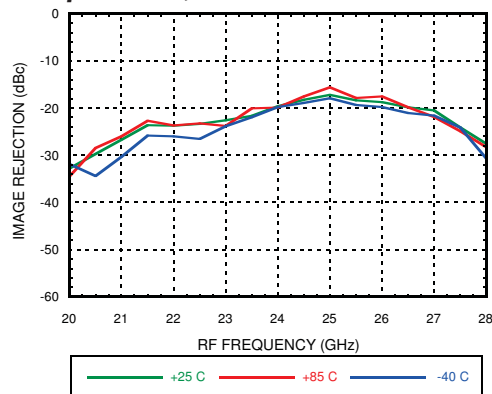

**Input IP3 vs. RF Frequency Over Temperature, LO Drive = 6 dBm**

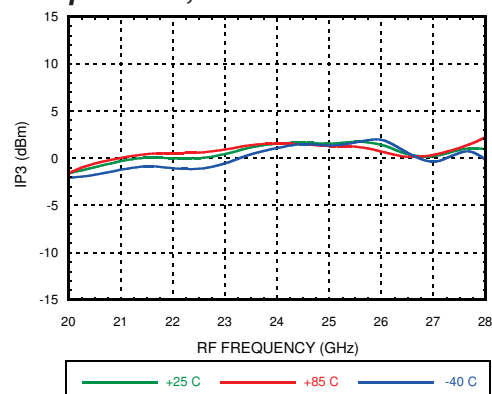

**Input IP3 vs. RF Frequency at Various LO Drives**

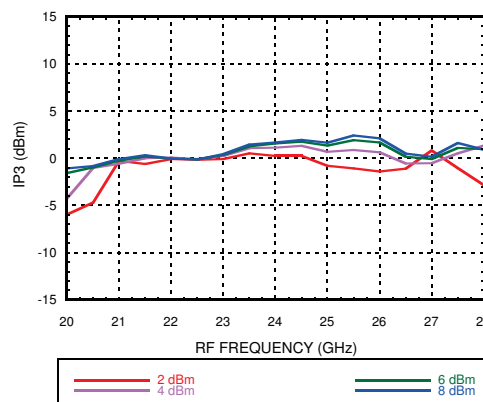

Information furnished by Analog Devices is believed to be accurate and reliable. However, no responsibility is assumed by Analog Devices for its use, nor for any infringements of patents or other rights of third parties that may result from its use. Specifications subject to change without notice. No license is granted by implication or otherwise under any patent or patent rights of Analog Devices. Trademarks and registered trademarks are the property of their respective owners.

For price, delivery, and to place orders: Analog Devices, Inc., One Technology Way, P.O. Box 9106, Norwood, MA 02062-9106 Phone: 781-329-4700 • Order online at [www.analog.com](http://www.analog.com) Application Support: Phone: 1-800-ANALOG-D

**GaAs MMIC I/Q DOWNCONVERTER  
20 - 28 GHz**



Data Taken As IRM With External 90° Hybrid at The IF Ports, IF = 2000 MHz, LSB

**Conversion Gain vs. RF Frequency Over Temperature, LO Drive = 6 dBm**

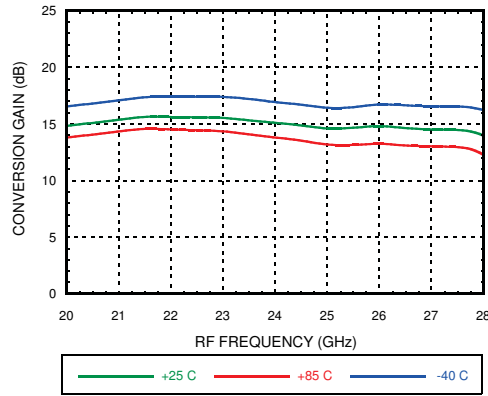

**Conversion Gain vs. RF Frequency at Various LO Drives**

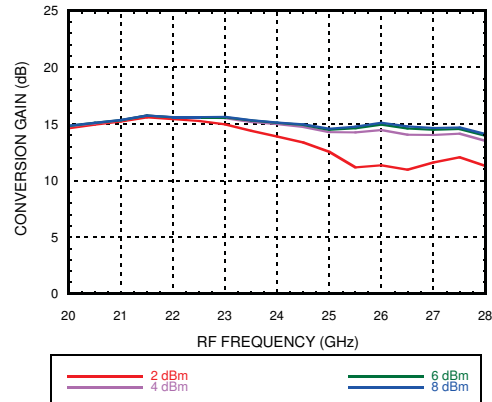

**Image Rejection vs. RF Frequency Over Temperature, LO Drive = 6 dBm**

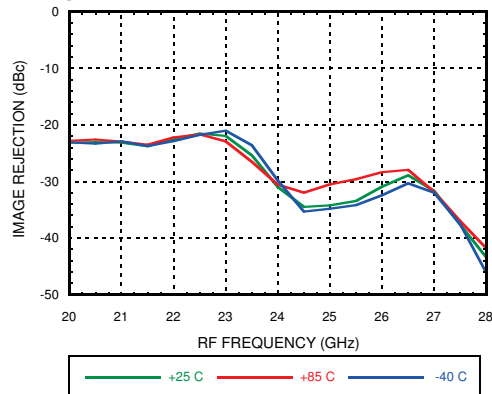

**Input IP3 vs. RF Frequency Over Temperature, LO Drive = 6 dBm**

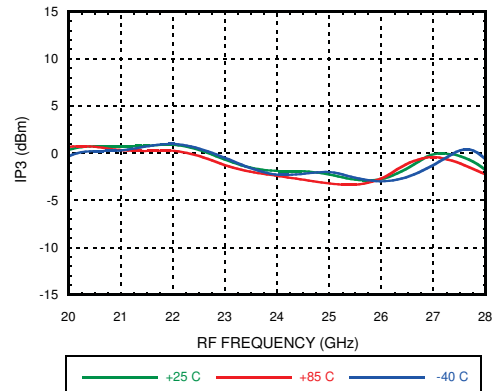

**Input IP3 vs. RF Frequency at Various LO Drives**

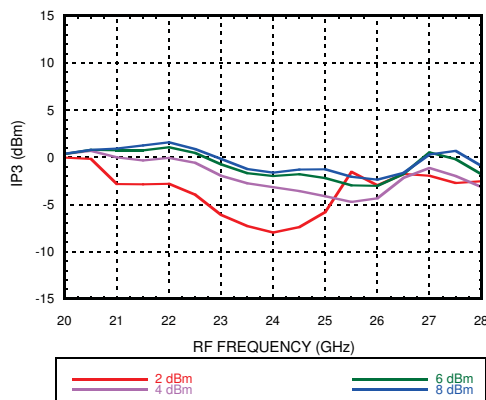

Information furnished by Analog Devices is believed to be accurate and reliable. However, no responsibility is assumed by Analog Devices for its use, nor for any infringements of patents or other rights of third parties that may result from its use. Specifications subject to change without notice. No license is granted by implication or otherwise under any patent or patent rights of Analog Devices. Trademarks and registered trademarks are the property of their respective owners.

For price, delivery, and to place orders: Analog Devices, Inc., One Technology Way, P.O. Box 9106, Norwood, MA 02062-9106 Phone: 781-329-4700 • Order online at [www.analog.com](http://www.analog.com) Application Support: Phone: 1-800-ANALOG-D



**GaAs MMIC I/Q DOWNCONVERTER  
20 - 28 GHz**

Data Taken As IRM With External 90° Hybrid at The IF Ports, IF = 3300 MHz, USB

**Conversion Gain vs. RF Frequency Over Temperature, LO Drive = 6 dBm**

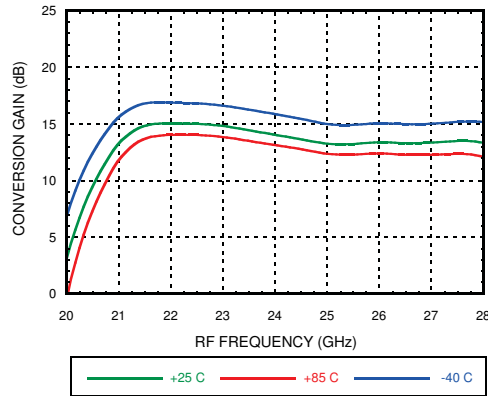

**Conversion Gain vs. RF Frequency at Various LO Drives**

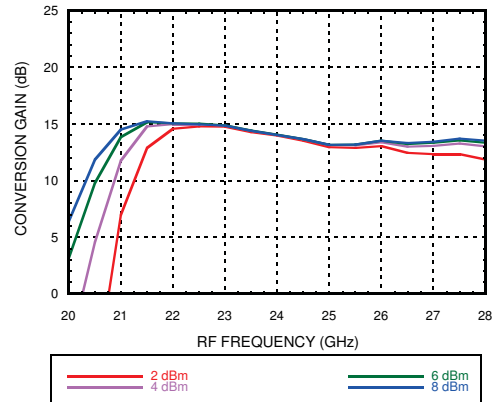

**Image Rejection vs. RF Frequency Over Temperature, LO Drive = 6 dBm**

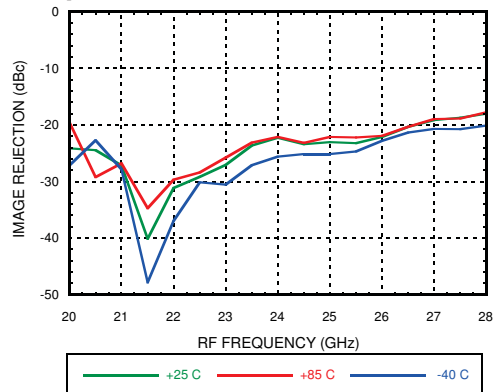

**Input IP3 vs. RF Frequency Over Temperature, LO Drive = 6 dBm**

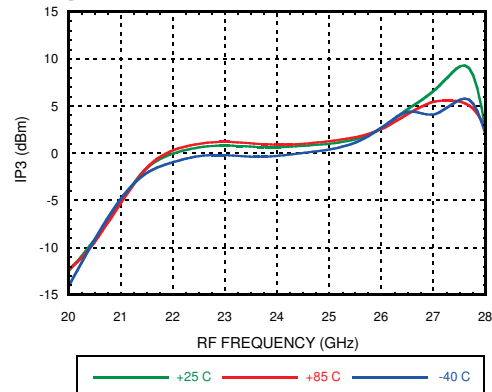

**Input IP3 vs. RF Frequency at Various LO Drives**

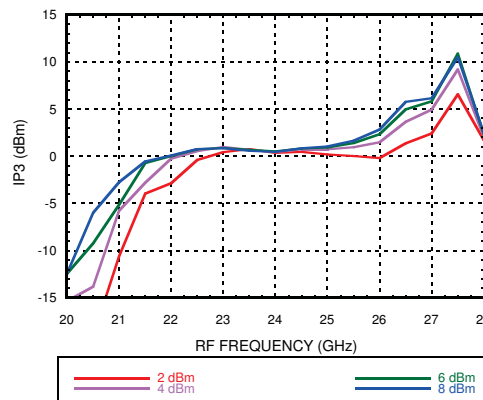

Information furnished by Analog Devices is believed to be accurate and reliable. However, no responsibility is assumed by Analog Devices for its use, nor for any infringements of patents or other rights of third parties that may result from its use. Specifications subject to change without notice. No license is granted by implication or otherwise under any patent or patent rights of Analog Devices. Trademarks and registered trademarks are the property of their respective owners.

For price, delivery, and to place orders: Analog Devices, Inc., One Technology Way, P.O. Box 9106, Norwood, MA 02062-9106 Phone: 781-329-4700 • Order online at [www.analog.com](http://www.analog.com) Application Support: Phone: 1-800-ANALOG-D



**GaAs MMIC I/Q DOWNCONVERTER  
20 - 28 GHz**



Data Taken As IRM With External 90° Hybrid at The IF Ports, IF = 3300 MHz, LSB

**Conversion Gain vs. RF Frequency Over Temperature, LO Drive = 6 dBm**

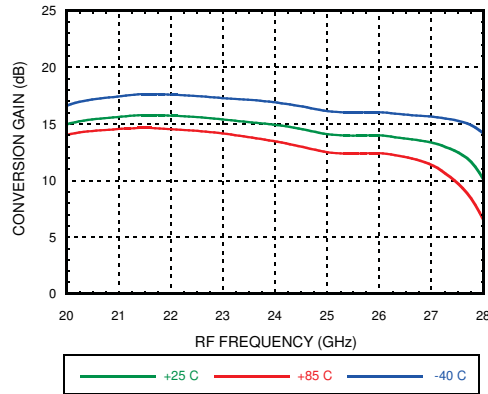

**Conversion Gain vs. RF Frequency at Various LO Drives**

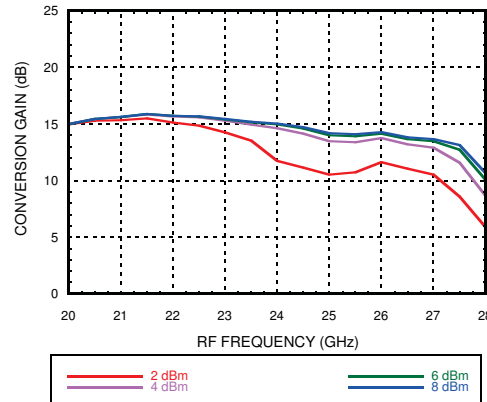

**Image Rejection vs. RF Frequency Over Temperature, LO Drive = 6 dBm**

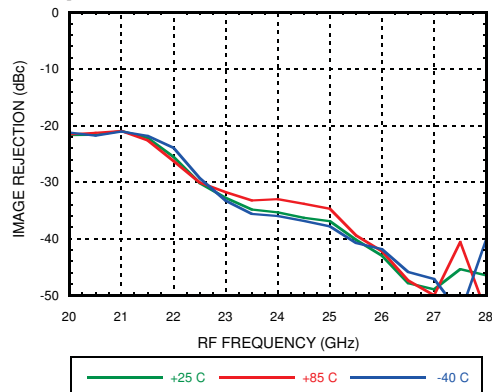

**Input IP3 vs. RF Frequency Over Temperature, LO Drive = 6 dBm**

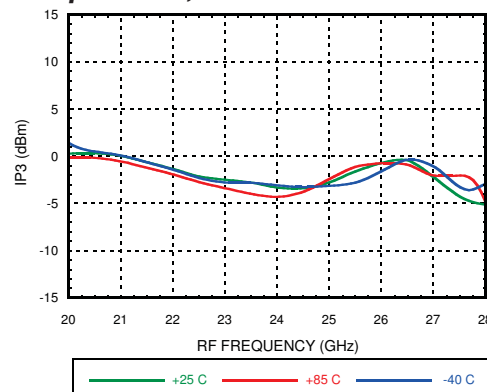

**Input IP3 vs. RF Frequency at Various LO Drives**

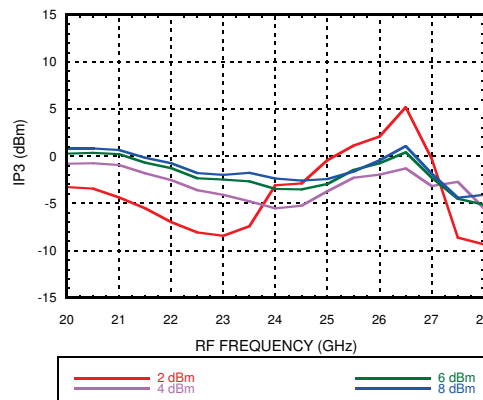

Information furnished by Analog Devices is believed to be accurate and reliable. However, no responsibility is assumed by Analog Devices for its use, nor for any infringements of patents or other rights of third parties that may result from its use. Specifications subject to change without notice. No license is granted by implication or otherwise under any patent or patent rights of Analog Devices. Trademarks and registered trademarks are the property of their respective owners.

For price, delivery, and to place orders: Analog Devices, Inc., One Technology Way, P.O. Box 9106, Norwood, MA 02062-9106 Phone: 781-329-4700 • Order online at [www.analog.com](http://www.analog.com) Application Support: Phone: 1-800-ANALOG-D



## GaAs MMIC I/Q DOWNCONVERTER 20 - 28 GHz

### Absolute Maximum Ratings

RF Input Power	2 dBm
LO Drive	10 dBm
Drain Bias (V <sub>dd</sub> )	5.0 V
Channel Temperature	175 °C
Continuous Pdiss (T=85°C) (derate 17.7 mW/°C above 85°C)	1.6 W
Thermal Resistance (R <sub>th</sub> ) (channel to package bottom)	56.3 °C/W
Storage Temperature Range	-65 °C to +150 °C
Operating Temperature Range	-40 °C to +85 °C
ESD Sensitivity (HBM)	Class 1A (250 V)



ELECTROSTATIC SENSITIVE DEVICE  
OBSERVE HANDLING PRECAUTIONS

### Outline Drawing

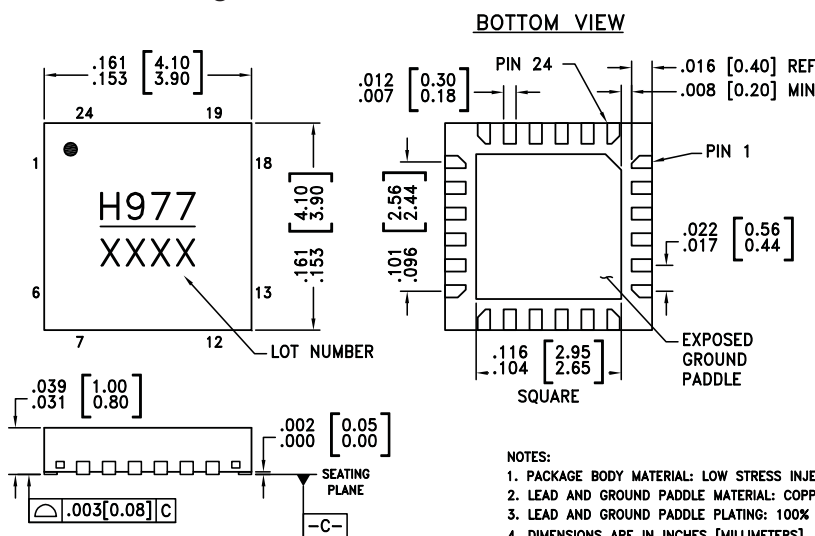

#### NOTES:

1. PACKAGE BODY MATERIAL: LOW STRESS INJECTION MOLDED PLASTIC SILICA AND SILICON IMPREGNATED.
2. LEAD AND GROUND PADDLE MATERIAL: COPPER ALLOY.
3. LEAD AND GROUND PADDLE PLATING: 100% MATTE TIN
4. DIMENSIONS ARE IN INCHES [MILLIMETERS].
5. LEAD SPACING TOLERANCE IS NON-CUMULATIVE.
6. CHARACTERS TO BE HELVETICA MEDIUM, .025 HIGH, WHITE INK, OR LASER MARK LOCATED APPROX. AS SHOWN.
7. PAD BURR LENGTH SHALL BE 0.15mm MAX. PAD BURR HEIGHT SHALL BE 0.05mm MAX.
8. PACKAGE WARP SHALL NOT EXCEED 0.05mm
9. ALL GROUND LEADS AND GROUND PADDLE MUST BE SOLDERED TO PCB RF GROUND.
10. REFER TO HITTITE APPLICATION NOTE FOR SUGGESTED PCB LAND PATTERN.

### Package Information

Part Number	Package Body Material	Lead Finish	MSL Rating	Package Marking <sup>[1]</sup>
HMC977LP4E	RoHS-Compliant Low Stress Injection Molded Plastic	100% Matte Sn	MSL1 <sup>[2]</sup>	H977 XXXX

[1] 4-Digit lot number XXXX

[2] Max peak reflow temperature of 260 °C



## GaAs MMIC I/Q DOWNCONVERTER 20 - 28 GHz

### Pin Descriptions

Pin Number	Function	Description	Interface Schematic
1, 2, 6, 7, 10 - 12, 15, 18 - 22	N/C	No Connection. The pins are not connected internally.	
3	VDRF	Power supply for the RF low noise amplifier.	
4	VDLO2	Power supply for the second stage LO amplifier.	
5	VDLO1	Power supply for the first stage LO amplifier.	
8	LO	Local Oscillator. This pin is ac-coupled and matched to 50 Ohms.	
9, 13, 17, 24	GND	Ground Connect. Connect these pins and the package bottom to RF/dc ground.	
16	IF2	Second and First Intermediate Frequency Port. These pins are dc-coupled. For applications not requiring operation to dc, block these pins externally using a series capacitor with a value chosen to pass the necessary IF frequency range. For operation to dc, these pins must not source or sink more than 3 mA of current or device non-functionality or device failure may result.	
14	IF1		
23	RF	Radio Frequency Port. This pin is ac-coupled and matched to 50 Ohms.	

### Typical Application Circuit

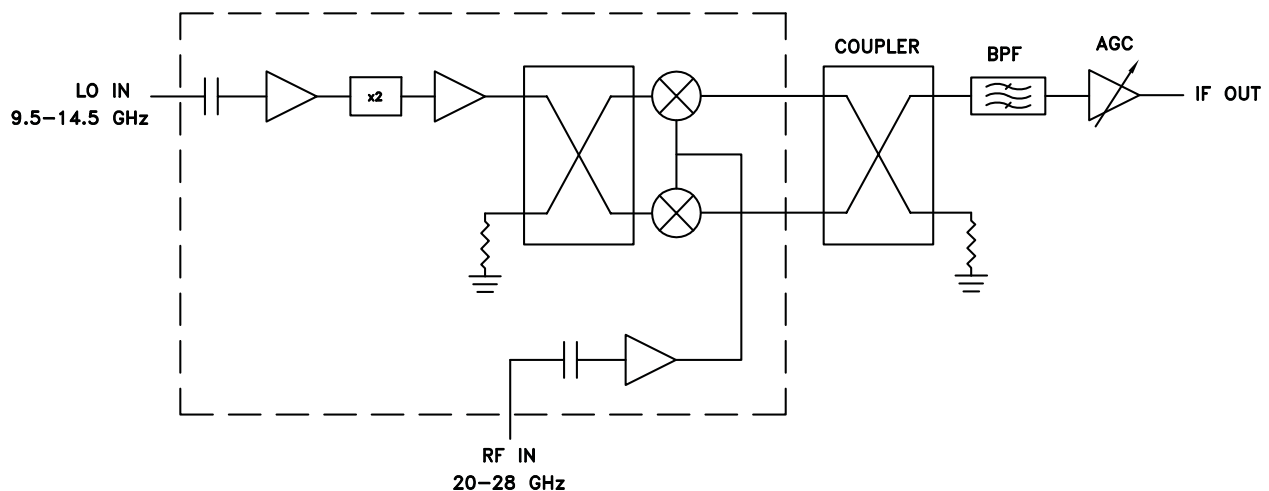

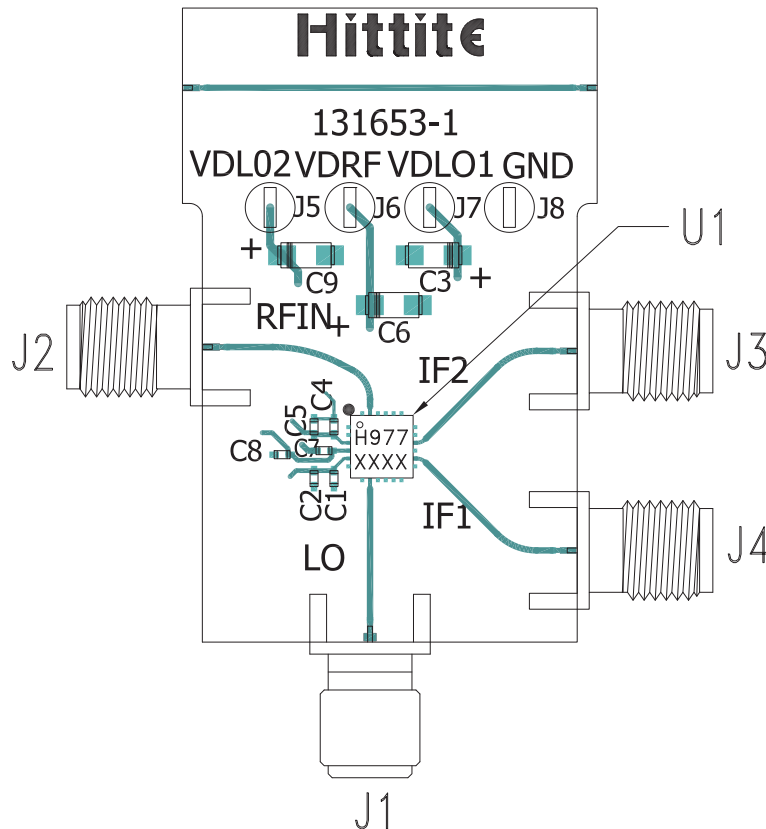
**GaAs MMIC I/Q DOWNCONVERTER  
20 - 28 GHz**
**Evaluation PCB**

**List of Materials for Evaluation PCB 131656 [1]**

Item	Description
J1	PCB Mount SMA RF Connector, SRI
J2, J3	PCB Mount K Connector, SRI
J5 - J8	DC Pin
C1, C4, C7	100 pF Capacitor, 0402 Pkg.
C2, C5, C8	10 nF Capacitor, 0402 Pkg.
C3, C6, C9	4.7 $\mu$ F Capacitor, Case A Pkg.
U1	HMC977LP4E
PCB [2]	161653 Evaluation Board

[1] Reference this number when ordering complete evaluation PCB

[2] Circuit Board Material: Rogers 4350

The circuit board used in the application should use RF circuit design techniques. Signal lines should have 50 Ohm impedance while the package ground leads and exposed paddle should be connected directly to the ground plane similar to that shown. A sufficient number of via holes should be used to connect the top and bottom ground planes. The evaluation circuit board shown is available from Analog Devices upon request.